

DETAIL A

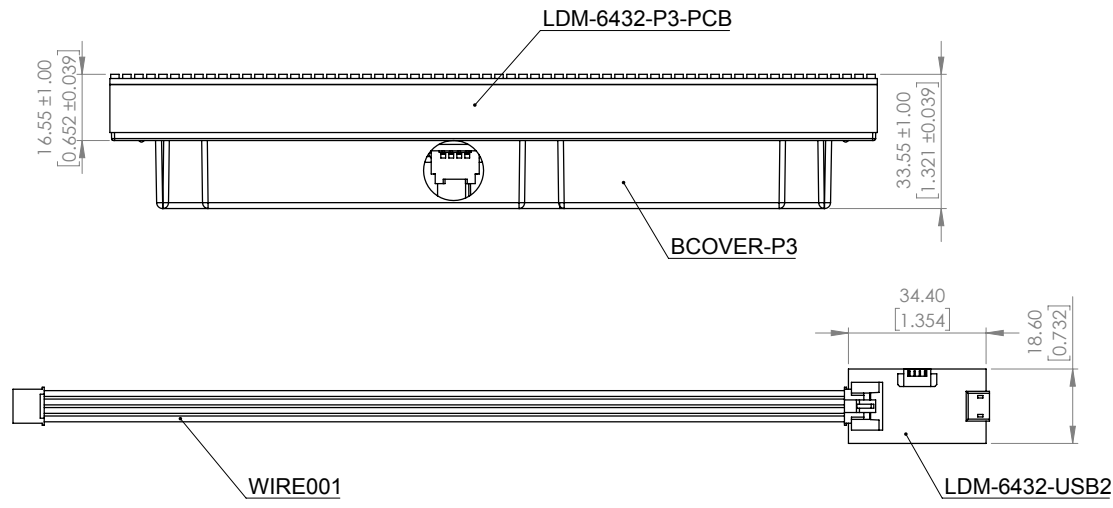

COMPONENT

ITEM	P/N	QTY.
1	LDM-6432-P3-PCB	1
2	LDM-6432-1LT-RGB-E	1
3	LDM-6432-AMPERE	1
4	LDM-6432-USB2	1
5	LDM-6432-BLE4	1
6	BCOVER-P3	1
7	WIRE001	2

*UNLESS OTHERWISE SPECIFIED TOLERANCES PER DECIMAL PRECISION ARE: X=±1 (±0.039), X.X=±0.5 (±0.020), X.XX=±0.25 (±0.010), X.XXX=±0.127 (±0.005). LEAD SIZE=±0.05 (±0.002), LEAD LENGTH=±0.75 (±0.030). MIN=+DECIMAL PRECISION -0.00, MAX.=+0.00 -DECIMAL PRECISION



425 N. GARY AVE.
CAROL STREAM, IL 60188
PHONE : 800-278-5666
FAX : 630-315-2150
WEB : WWW.LUMEX.COM

ezDisplay P3 DOT MATRIX, 64*32 PIXEL, RGB LEDs, UART INTERFACE, BLUE TOOTH, DC 5V

****THE SPECIFICATIONS MAY CHANGE AT ANY TIME WITHOUT NOTICE DUE TO NEW MATERIALS OR PRODUCT IMPROVEMENT.****

CONFIDENTIAL INFORMATION
THE INFORMATION CONTAINED IN THIS DOCUMENT IS THE PROPERTY OF LUMEX INC. EXCEPT AS SPECIFICALLY AUTHORIZED IN WRITING BY LUMEX INC., THE HOLDER OF THIS DOCUMENT SHALL KEEP ALL INFORMATION CONTAINED HEREIN CONFIDENTIAL AND SHALL PROTECT SAME IN WHOLE OR IN PART FROM DISCLOSURE AND DISSEMINATION TO ALL THIRD PARTIES.

DATE : 2018.04.19	DRAWN BY : C.C.
PAGE : 1 OF 5	CHKD BY : E.C.
SCALE : NTF	APRVD BY : G.Y.
UNIT : mm [INCH]	Ⓢ

GENERAL SPECIFICATION

ITEM	DESCRIPTION	UNIT
MODULE SIZE	192(L) ×96(W)	mm
PIXEL PITCH	3	mm
PIXEL FORM	RGB	--
PIXEL DENSITY	111111	dot/m2
MODULE RESOLUTION	64x32	dot
DRIVE METHOD	1/16 SCAN	--
CONTROLLER INTERFACE	UART	--
POWER CONSUMPTION	7.5 MAX	W
BRIGHTNESS	450 MIN	cd/m2
TEMPERATURE RANGE	-20~60, 10~80%RH	°C
FRAME COLOR	BLACK	°C

WIRELEAD DEFINITION

P/N	COLOR	DEFINITION
WIRE001	YELLOW	TX1
	WHITE	RX1
	RED	5V
	BLACK	GND

UART CONFIGURATION

ITEM	SETTING VALUE
BAUD RATE	115200
DATA BIT	8
STOP BIT	1
PARITY BIT	NONE
FLOW CONTROL	NONE

*UNLESS OTHERWISE SPECIFIED TOLERANCES PER DECIMAL PRECISION ARE: X=±1 (±0.039), X.X=±0.5 (±0.020), X.XX=±0.25 (±0.010), X.XXX=±0.127 (±0.005). LEAD SIZE=±0.05 (±0.002), LEAD LENGTH=±0.75 (±0.030). MIN=^{+DECIMAL PRECISION}_{-0.00} MAX.=^{+0.00}_{-DECIMAL PRECISION}



425 N. GARY AVE.
CAROL STREAM, IL 60188
PHONE : 800-278-5666
FAX : 630-315-2150
WEB : WWW.LUMEX.COM

ezDisplay P3 DOT MATRIX, 64*32 PIXEL, RGB LEDs, UART INTERFACE, BLUE TOOTH, DC 5V

****THE SPECIFICATIONS MAY CHANGE AT ANY TIME WITHOUT NOTICE DUE TO NEW MATERIALS OR PRODUCT IMPROVEMENT.****

CONFIDENTIAL INFORMATION
THE INFORMATION CONTAINED IN THIS DOCUMENT IS THE PROPERTY OF LUMEX INC. EXCEPT AS SPECIFICALLY AUTHORIZED IN WRITING BY LUMEX INC., THE HOLDER OF THIS DOCUMENT SHALL KEEP ALL INFORMATION CONTAINED HEREIN CONFIDENTIAL AND SHALL PROTECT SAME IN WHOLE OR IN PART FROM DISCLOSURE AND DISSEMINATION TO ALL THIRD PARTIES.

DATE : 2018.04.19	DRAWN BY : C.C.
PAGE : 2 OF 5	CHKD BY : E.C.
SCALE : NTF	APRVD BY : G.Y.
UNIT : mm [INCH]	Ⓜ

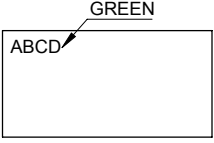
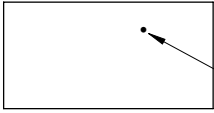
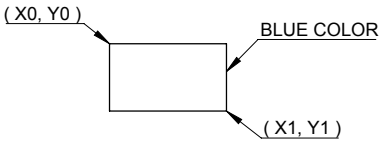
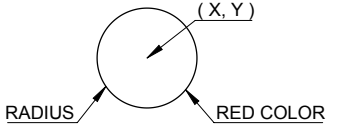
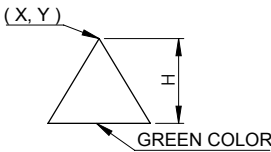
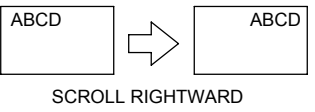
DIAGRAM	COMMAND*	EXAMPLE
	Write a 5x7 RGB String	<code>ate1=(line,column,Color 0~255*,String)</code> <code>ate1=(0,0,4,ABCD)</code>
	Set a Color Pixel	<code>atee=(X position,Y position, Color 0~255*)</code> <code>atee=(48,6,96) : '96' Red color</code>
	Draw a Rectangle	<code>at91=(X0 position,Y0 position,X1 position,Y1 position,Color 0~255*)</code> <code>at91=(0,0,55,7,2) : '2' blue color</code>
	Draw a Circle	<code>at94=(X position,Y position,Radius,Color 0~255*)</code> <code>at94=(48,4,3,64) : '64' red color</code>
	Draw a tip upward Triangle	<code>at96=(X position,Y position,Height,Color 0~255*)</code> <code>at96=(48,1,3,4) : '4' green color</code>
	Scroll the whole display rightward	<code>atd5=(shif time in ms)</code> <code>atd5=(20)</code>

* Please refer to detail commands/ COLOR CODE Table on Lumex website: www.lumex.com/ezdisplay

*UNLESS OTHERWISE SPECIFIED TOLERANCES PER DECIMAL PRECISION ARE: X=±1 (±0.039), X.X=±0.5 (±0.020), X.XX=±0.25 (±0.010), X.XXX=±0.127 (±0.005). LEAD SIZE=±0.05 (±0.002), LEAD LENGTH=±0.75 (±0.030). MIN=^{+DECIMAL PRECISION}_{-0.00} MAX.=^{+0.00}_{-DECIMAL PRECISION}



425 N. GARY AVE.
 CAROL STREAM, IL 60188
 PHONE : 800-278-5666
 FAX : 630-315-2150
 WEB : WWW.LUMEX.COM

ezDisplay P3 DOT MATRIX, 64*32 PIXEL, RGB LEDs, UART INTERFACE, BLUE TOOTH, DC 5V

THE SPECIFICATIONS MAY CHANGE AT ANY TIME WITHOUT NOTICE DUE TO NEW MATERIALS OR PRODUCT IMPROVEMENT.

CONFIDENTIAL INFORMATION
 THE INFORMATION CONTAINED IN THIS DOCUMENT IS THE PROPERTY OF LUMEX INC. EXCEPT AS SPECIFICALLY AUTHORIZED IN WRITING BY LUMEX INC., THE HOLDER OF THIS DOCUMENT SHALL KEEP ALL INFORMATION CONTAINED HEREIN CONFIDENTIAL AND SHALL PROTECT SAME IN WHOLE OR IN PART FROM DISCLOSURE AND DISSEMINATION TO ALL THIRD PARTIES.

DATE : 2018.04.19	DRAWN BY : C.C.
PAGE : 3 OF 5	CHKD BY : E.C.
SCALE : NTF	APRVD BY : G.Y.
UNIT : mm [INCH]	Ⓢ

COLOR CODE TABLE

0	1	2	3	4	5	6	7	8	9	10	11	12	13	14	15
32	33	34	35	36	37	38	39	40	41	42	43	44	45	46	47
64	65	66	67	68	69	70	71	72	73	74	75	76	77	78	79
96	97	98	99	100	101	102	103	104	105	106	107	108	109	110	111

*UNLESS OTHERWISE SPECIFIED TOLERANCES PER DECIMAL PRECISION ARE: X=±1 (±0.039), X.X=±0.5 (±0.020), X.XX=±0.25 (±0.010), X.XXX=±0.127 (±0.005). LEAD SIZE=±0.05 (±0.002), LEAD LENGTH=±0.75 (±0.030). MIN=^{+DECIMAL PRECISION}_{-0.00} MAX.=^{+0.00}_{-DECIMAL PRECISION}

 <p>425 N. GARY AVE. CAROL STREAM, IL 60188 PHONE : 800-278-5666 FAX : 630-315-2150 WEB : WWW.LUMEX.COM</p>	ezDisplay P3 DOT MATRIX, 64*32 PIXEL, RGB LEDs, UART INTERFACE, BLUE TOOTH, DC 5V	DATE : 2018.04.19	DRAWN BY : C.C.	
	THE SPECIFICATIONS MAY CHANGE AT ANY TIME WITHOUT NOTICE DUE TO NEW MATERIALS OR PRODUCT IMPROVEMENT.	PAGE : 4 OF 5	CHKD BY : E.C.	
	CONFIDENTIAL INFORMATION THE INFORMATION CONTAINED IN THIS DOCUMENT IS THE PROPERTY OF LUMEX INC. EXCEPT AS SPECIFICALLY AUTHORIZED IN WRITING BY LUMEX INC., THE HOLDER OF THIS DOCUMENT SHALL KEEP ALL INFORMATION CONTAINED HEREIN CONFIDENTIAL AND SHALL PROTECT SAME IN WHOLE OR IN PART FROM DISCLOSURE AND DISSEMINATION TO ALL THIRD PARTIES.	SCALE : NTF	APRVD BY : G.Y.	
		UNIT : mm [INCH]		

ASCII CODE OF 5X7 FONTS AND 8X16 FONTS

Hex	Symbol	Hex	Symbol	Hex	Symbol
0x20		0x40	@	0x60	`
0x21	!	0x41	A	0x61	a
0x22	"	0x42	B	0x62	b
0x23	#	0x43	C	0x63	c
0x24	\$	0x44	D	0x64	d
0x25	%	0x45	E	0x65	e
0x26	&	0x46	F	0x66	f
0x27		0x47	G	0x67	g
0x28	(0x48	H	0x68	h
0x29)	0x49	I	0x69	i
0x2a	*	0x4a	J	0x6a	j
0x2b	+	0x4b	K	0x6b	k
0x2c	,	0x4c	L	0x6c	l
0x2d	-	0x4d	M	0x6d	m
0x2e	.	0x4e	N	0x6e	n
0x2f		0x4f	O	0x6f	o
0x30	0	0x50	P	0x70	p
0x31	1	0x51	Q	0x71	q
0x32	2	0x52	R	0x72	r
0x33	3	0x53	S	0x73	s
0x34	4	0x54	T	0x74	t
0x35	5	0x55	U	0x75	u
0x36	6	0x56	V	0x76	v
0x37	7	0x57	W	0x77	w
0x38	8	0x58	X	0x78	x
0x39	9	0x59	Y	0x79	y
0x3a	:	0x5a	Z	0x7a	z
0x3b	;	0x5b]	0x7a	{
0x3c	<	0x5c	\	0x7a	
0x3d	=	0x5d	[0x7a	}
0x3e	>	0x5e	^	0x7a	~
0x3f	?	0x5f	_	0x7a	<-

ASCII code of 16X16 fonts

Hex	Symbol
0x30	0
0x31	1
0x32	2
0x33	3
0x34	4
0x35	5
0x36	6
0x37	7
0x38	8
0x39	9

No. of 8X16 pattern

No.	Symbol
0	0
1	1
2	2
3	3
4	4
5	5
6	6
7	7
8	8
9	9

No. of 32X32 pattern

No.	Symbol
0	0
1	1
2	2
3	3
4	4
5	5
6	6
7	7
8	8
9	9
10	°C
11	°F
12	

No. of 8X8 pattern

No.	Symbol
0	0
1	1
2	2
3	3
4	4
5	5
6	6
7	7
8	8
9	9

No. of 16X16 pattern

No.	Symbol
0	0
1	1
2	2
3	3
4	4
5	5
6	6
7	7
8	8
9	9

*UNLESS OTHERWISE SPECIFIED TOLERANCES PER DECIMAL PRECISION ARE: X=±1 (±0.039), X.X=±0.5 (±0.020), X.XX=±0.25 (±0.010), X.XXX=±0.127 (±0.005). LEAD SIZE=±0.05 (±0.002), LEAD LENGTH=±0.75 (±0.030). MIN=^{+0.00}_{-0.00} DECIMAL PRECISION MAX=^{+0.00}_{-DECIMAL PRECISION}

 <p>425 N. GARY AVE. CAROL STREAM, IL 60188 PHONE : 800-278-5666 FAX : 630-315-2150 WEB : WWW.LUMEX.COM</p>	ezDisplay P3 DOT MATRIX, 64*32 PIXEL, RGB LEDs, UART INTERFACE, BLUE TOOTH, DC 5V	DATE : 2018.04.19	DRAWN BY : C.C.
	THE SPECIFICATIONS MAY CHANGE AT ANY TIME WITHOUT NOTICE DUE TO NEW MATERIALS OR PRODUCT IMPROVEMENT.	PAGE : 5 OF 5	CHKD BY : E.C.
	CONFIDENTIAL INFORMATION	SCALE : NTF	APRVD BY : G.Y.
	THE INFORMATION CONTAINED IN THIS DOCUMENT IS THE PROPERTY OF LUMEX INC. EXCEPT AS SPECIFICALLY AUTHORIZED IN WRITING BY LUMEX INC., THE HOLDER OF THIS DOCUMENT SHALL KEEP ALL INFORMATION CONTAINED HEREIN CONFIDENTIAL AND SHALL PROTECT SAME IN WHOLE OR IN PART FROM DISCLOSURE AND DISSEMINATION TO ALL THIRD PARTIES.	UNIT : mm [INCH]	