

LTC3106EUDC
300mA, Low Voltage Buck-Boost Converter with PowerPath and 1.6 μ A Quiescent Current
DESCRIPTION

Demonstration circuit DC2255A features the **LTC[®]3106**, an ultralow input voltage buck-boost DC/DC converter with automatic PowerPath™ management optimized for multisource, low power systems. Burst Mode® operation architecture allows the LTC3106 to run very efficiently with as little as 1.6 μ A of input current at no load.

Programmable accurate RUN threshold as well as maximum power point control (MPPC) allow for simple optimization of power transfer between the power source and the input supply to the DC2255A. Selectable peak current limit (100mA or 725mA) also allows the LTC3106 to adapt to a wide variety of input supplies.

An accurate RUN threshold voltage of $V_{IN} = 1.2V$ is set by positioning the shunt on JP12 in the middle position. This threshold is set by the values of R4 and R5. For maximum power point control setpoint above 0.6V, it is usually better to use the accurate RUN functionality. See the data sheet for more details. Maximum power point control is enabled by setting JP5 to V_{CC} . The value of R3 sets the MPPC threshold.

The DC2255A has four user selectable output voltages: 1.8V, 2.2V, 3.3V and 5V. When the LTC3106 is enabled, the PGOOD pin asserts low if V_{OUT} is below the regulation voltage. If JP3 is set to V_{OUT} the red PGOOD indicator LED on the board lights up when the output is in regulation.

This is a visual indication of V_{OUT} being in regulation and is not needed for normal operation. To minimize current consumed, set JP3 to NC.

The LTC3106 can operate with either a primary or secondary battery on its V_{STORE} supply. In secondary mode (JP7 set to GND), the part will use excess power to trickle charge the battery on V_{STORE} . There are four pin selectable OV/UV thresholds for the battery voltage in this mode to allow operation with a variety of secondary batteries. If the DC2255A is operated in secondary mode, a Schottky diode must be placed between the SW2 and V_{AUX} pins.

The LTC3106 requires no external compensation and provides good line and load transient response across the entire V_{IN} range for each output voltage setting. This simplifies the design process while reducing the external component count.

The LTC3106 data sheet has detailed information about the operation, specifications, and applications of the part. The data sheet should be read in conjunction with this quick start guide.

Design files for this circuit board are available at <http://www.linear.com/demo/DC2255A>

LT, LTC, LTM, Linear Technology, the Linear logo, Dust and Burst Mode are registered trademarks and PowerPath is a trademark of Linear Technology Corporation. All other trademarks are the property of their respective owners.

PERFORMANCE SUMMARY Specifications are at $T_A = 25^\circ C$

SYMBOL	PARAMETER	CONDITIONS	MIN	TYP	MAX	UNITS
V_{IN}			0.350		5.1	V
V_{STORE}			2.1		4.3	V
V_{OUT}		1.8V, 2.2V, 3.3V and 5V Selectable Output Voltages		Option Dependent		V
I_{OUT}		$V_{IN} > V_{OUT}$		300		mA
	Efficiency			See Figures 1, 2		

PERFORMANCE SUMMARY

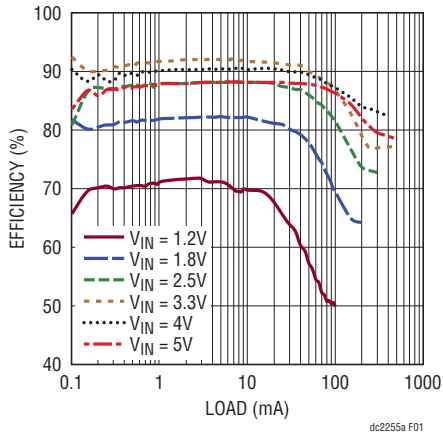

Figure 1. DC2255A Efficiency vs Load with Part Running from V_{IN} . $V_{OUT} = 3.3V$

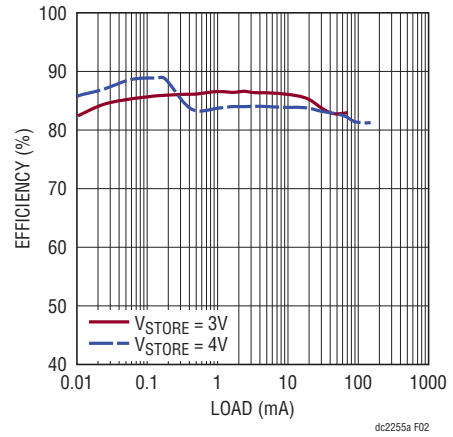

Figure 2. DC2255A Efficiency vs Load with Part Running from V_{STORE} Input. $V_{OUT} = 3.3V$

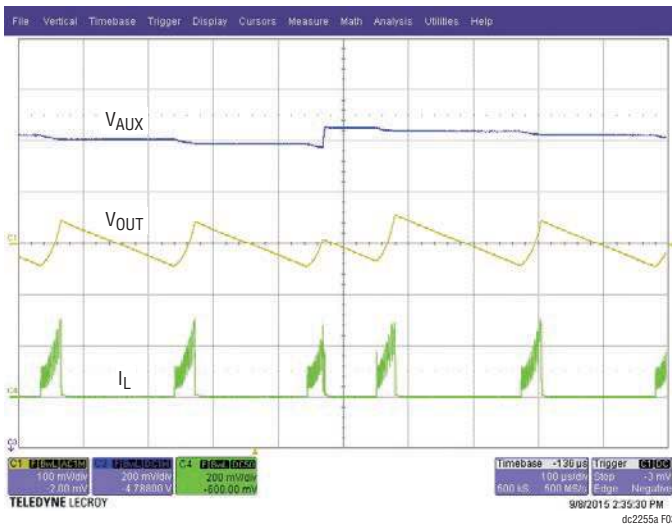

Figure 3. DC2255A Normal V_{AUX} , V_{OUT} and Inductor Current Behavior. The Middle V_{OUT} Charging Period Terminates Early to Charge Up V_{AUX} Because V_{AUX} Takes Priority Over V_{OUT}

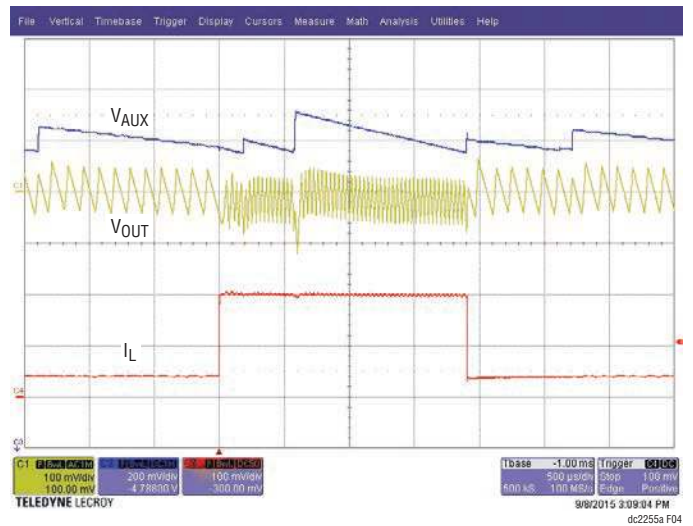

Figure 4. DC2255A Load Step Response. $V_{IN} = 3V$, $V_{OUT} = 3.3V$, Load Step is from 40mA to 200mA

QUICK START PROCEDURE

Using short twisted pair leads for any power connections and with all loads and power supplies off, refer to Figure 5 for the proper measurement and equipment setup. The power supplies (PS1 and PS2) should not be connected to the circuit until told to do so in the procedure below.

When measuring the input or output voltage ripple, care must be taken to avoid a long ground lead on the oscilloscope probe. Measure the input or output voltage ripple by touching the probe tip directly across the VIN, VSTORE or VOUT and GND terminals (see Figure 6), or by using an oscilloscope probe tip jack.

1. Jumper, Battery, PS1 and PS2 settings to start:

JP1, JP3:	NC
JP2:	VSTORE
JP4, JP5, JP7, JP8, JP10, JP11:	VCC
JP6:	VSTORE
JP9:	GND
JP12:	BYPASS
Battery in BTH1 (CR2032):	Not Populated
PS1:	OFF
PS2:	OFF

2. With power OFF connect the power supplies (PS1, PS2) as shown in Figure 5. If accurate current measurements are desired (for efficiency calculation for example) then connect ammeters in series with the supplies as shown. The ammeters are not required however.

3. Connect a 3.3mA load (1kΩ) to V_{OUT} as shown in Figure 5. Connect an ammeter in series if accurate current monitoring is desired.
4. Turn on PS1 and slowly increase the voltage until the voltage at V_{IN} is 1.2V.
5. Verify V_{OUT} is ~3.3V.
6. V_{IN} can now be varied between 600mV and 5.1V. V_{OUT} should remain in regulation. If V_{IN} is brought below 600mV, it will have to be brought back up above 1.2V to start up again.
7. Turn PS1 off.
8. Turn on PS2 and slowly increase voltage until voltage at V_{STORE} is 2.5V.
9. Verify V_{OUT} is ~3.3V.
10. V_{STORE} can now be varied between 2.1V and 4.3V.
11. If desired, turn off PS2 and populate BTH1 on the back of the board with a CR2032 or connect a different suitable battery (2.1V to 4.3V) to V_{STORE}.

NOTE1: Connector J1 is used to connect DC2255A to a Dust[®] Mote (see Figure 7). If unused, set JP1 to NC.

NOTE2: Connector J2 is used to facilitate connection to a solar cell PCB or other power supply board. Use of J2 is not required however, and solar cells or other suitable power sources can be connected directly to the V_{IN} or V_{STORE} terminal on the DC2255A.

CAUTION: DO NOT POWER VSTORE FROM AN EXTERNAL SUPPLY WITH A BATTERY IN BTH1.

QUICK START PROCEDURE

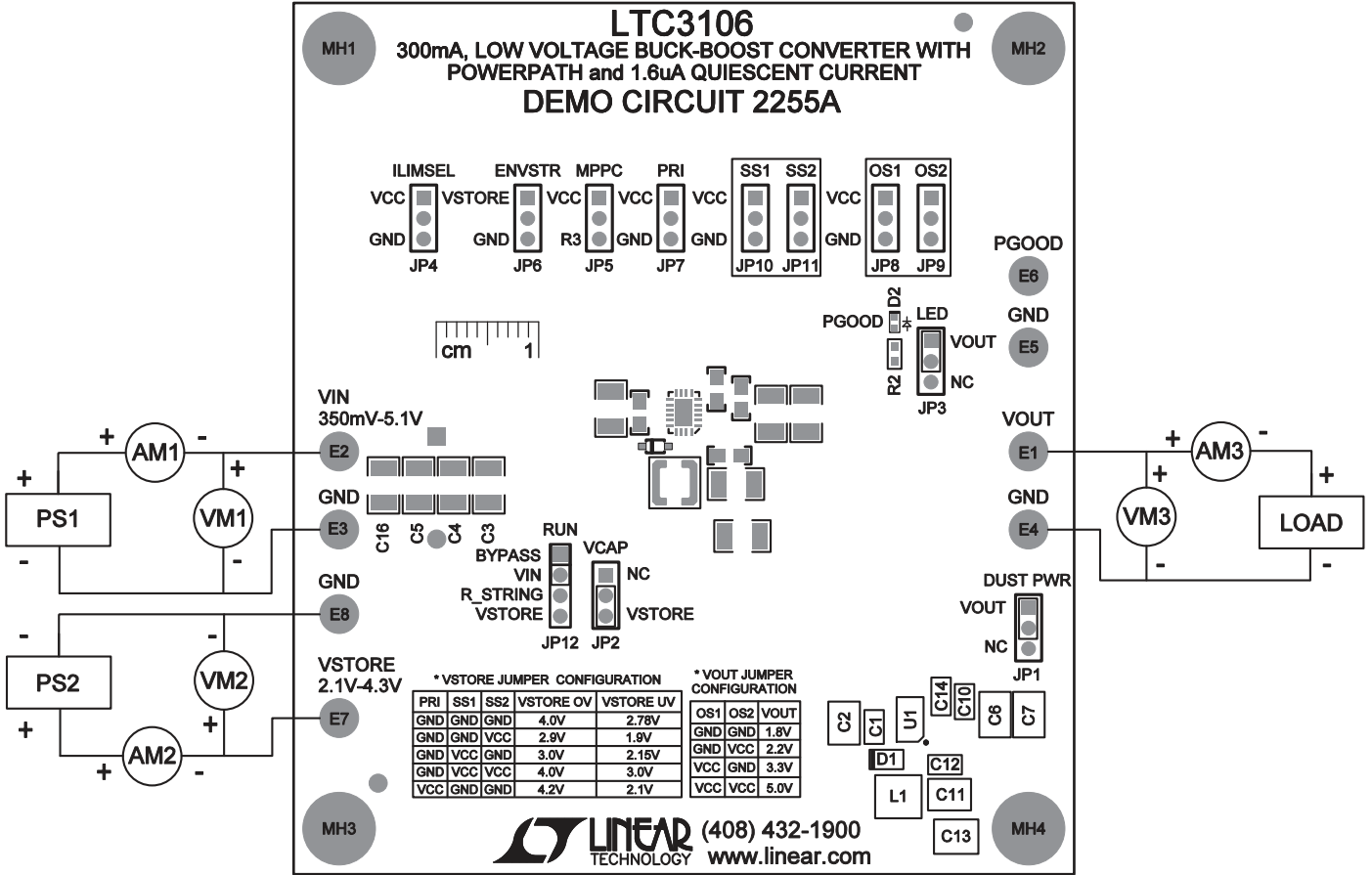

Figure 5. Proper Measurement and Equipment Setup

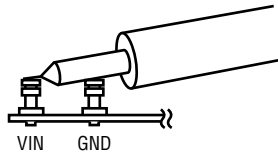

Figure 6. Measuring Input or Output Ripple

QUICK START PROCEDURE

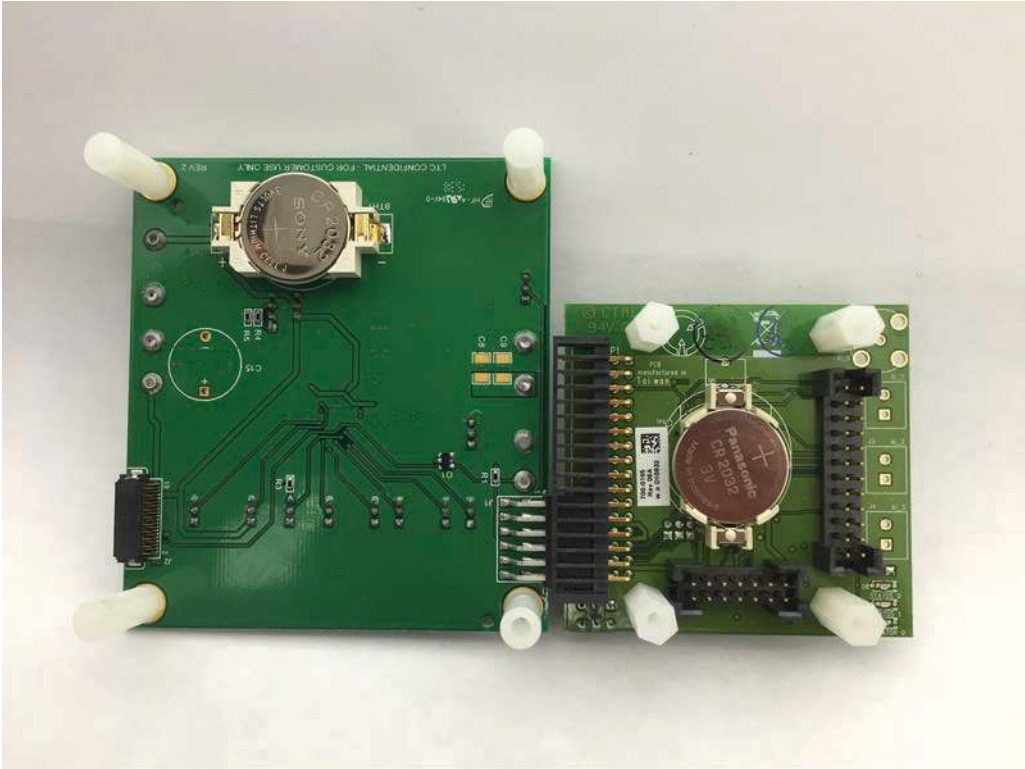

Figure 7. DC2255A Top and Bottom View of DC2255A Connected to Dust Mote.

DEMO MANUAL DC2255A

PARTS LIST

ITEM	QTY	REFERENCE	PART DESCRIPTION	MANUFACTURER/PART NUMBER
Required Circuit Components				
1	2	C1, C12	CAP CER 1 μ F 16V 10% X7R 0805	TDK, C2012X7R1C105K125AA
2	6	C2, C3, C4, C5, C6, C16	CAP CER 100 μ F 6.3V 20% X5R 1210	SAMSUNG, CL32A107MQVNNNE
3	1	C10	CAP CER 2.2 μ F 10V 20% X5R 0805	TDK, C2012X5R1A225M085AA
4	1	C11	CAP CER 47 μ F 10V 20% X5R 1210	SAMSUNG, CL32A476MPJNNNE
5	1	C14	CAP CER 0.1 μ F 6.3V 10% X7R 0805	KEMET, C0805C104K9RACTU
6	3	R1, R4, R5	RES 1M 1/10W 1% 0603 SMD	PANASONIC, ERJ-3EKF1004V
7	1	R2	RES., CHIP, 4.99k, 1/10W, 0603	PANASONIC, ERJ-3EKF4991V
8	1	R3	RES 301k 1/10W 1% 0603 SMD	PANASONIC, ERJ-3EKF3013V
9	1	D2	LED 0402 RED 50mW 20mA SMD	ROHM, SML-P11VTT86
10	1	L1	INDUCTOR, SHIELDED 10 μ H	COILCRAFT, LPS4018-103
11	1	Q1	MOSFET N-CHAN 20V SOT23-3	DIODES INC, ZXMN2F30FHTA
12	1	U1	300mA, LOW VOLTAGE BUCK-BOOST CONVERTER WITH PowerPath AND 1.6 μ A QUIESCENT CURRENT	LINEAR TECHNOLOGY, LTC3106EUDC#PBF
Additional Demo Board Circuit Components				
13	0	C7, C8, C9, C13	1210 CASE SIZE	
14	0	D1	DIODE SCHOTTKY 20V, 1A	NXP, PMEG2010EA
15	0	C15	CAP 100 μ F -20% +80% 5.5V T/H	EATON BUSSMANN, KR-5R5H104-R
Hardware: For Demo Board Only				
16	1	BATTERY	CR2032 COIN CELL BATTERY	DURACELL, CR2032
17	1	BTH1	CR2032 COIN CELL BATTERY HOLDER, SMD	WURTH, 79527141
18	8	E1-E8	TESTPOINT, TURRET, 0.095"	MILL-MAX, 2501-2-00-80-00-00-07-0
19	11	JP1-JP11	3 PIN 0.079 SINGLE ROW HEADER	SAMTEC, TMM-103-02-L-S
20	12	JP1-JP12	SHUNT	SAMTEC, 2SN-BK-G
21	1	JP12	4 PIN 0.079 SINGLE ROW HEADER	WURTH, 62000411121
22	4	(STAND-OFFS)	STAND-OFF, NYLON 0.75" TALL	KEYSTONE, 8834(SNAP ON)
23	1	J1	HEADER, 2X6, 12-PIN, SMT HORIZONTAL SOCKET W/KEY, 0.100"	SAMTEC, SMH-106-02-L-D-05
24	1	J2	CONN RECEPT 20POS 0.50" SMT	SAMTEC, SFMH-110-02-L-D-WT

SCHEMATIC DIAGRAM

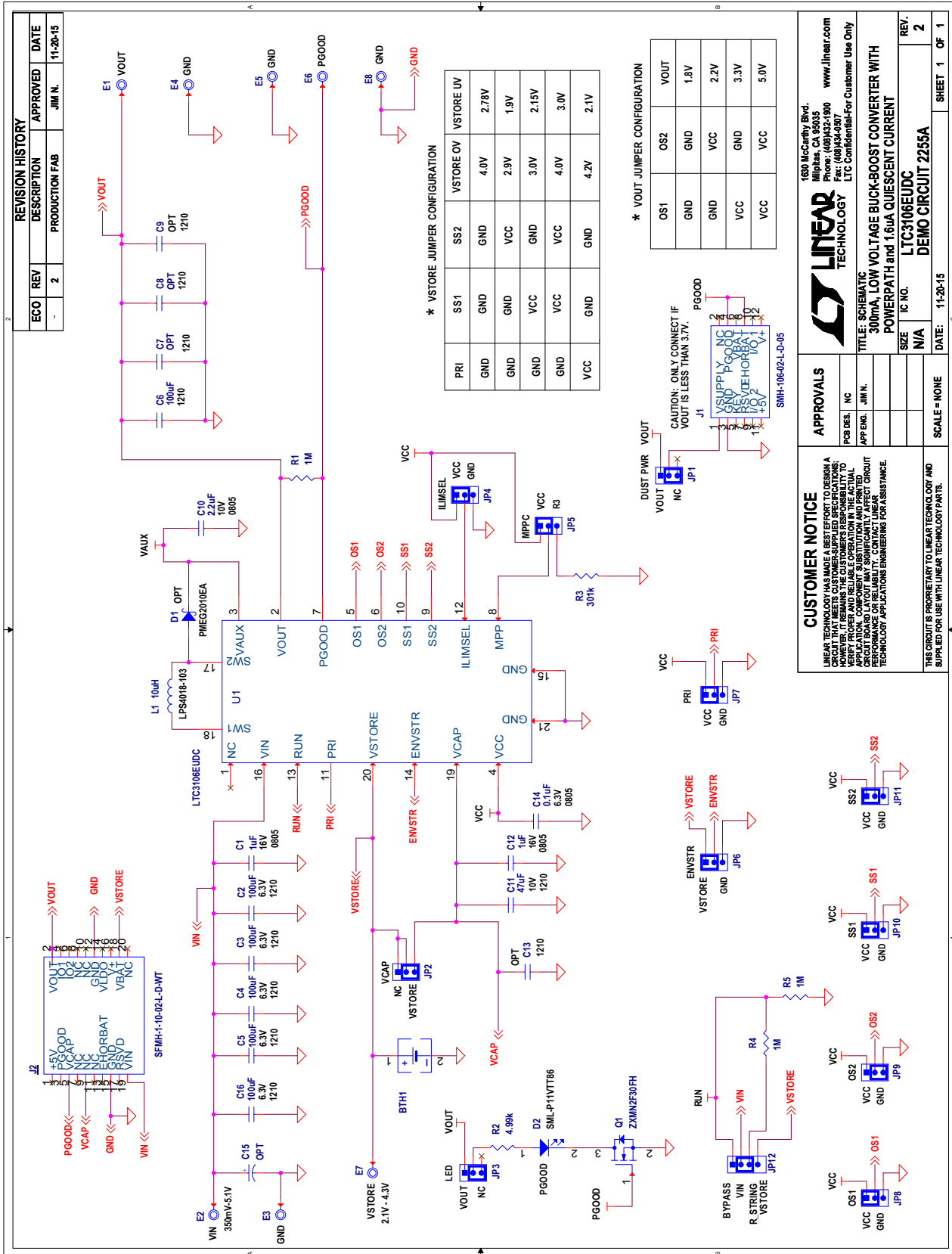

DEMO MANUAL DC2255A

DEMONSTRATION BOARD IMPORTANT NOTICE

Linear Technology Corporation (LTC) provides the enclosed product(s) under the following **AS IS** conditions:

This demonstration board (DEMO BOARD) kit being sold or provided by Linear Technology is intended for use for **ENGINEERING DEVELOPMENT OR EVALUATION PURPOSES ONLY** and is not provided by LTC for commercial use. As such, the DEMO BOARD herein may not be complete in terms of required design-, marketing-, and/or manufacturing-related protective considerations, including but not limited to product safety measures typically found in finished commercial goods. As a prototype, this product does not fall within the scope of the European Union directive on electromagnetic compatibility and therefore may or may not meet the technical requirements of the directive, or other regulations.

If this evaluation kit does not meet the specifications recited in the DEMO BOARD manual the kit may be returned within 30 days from the date of delivery for a full refund. **THE FOREGOING WARRANTY IS THE EXCLUSIVE WARRANTY MADE BY THE SELLER TO BUYER AND IS IN LIEU OF ALL OTHER WARRANTIES, EXPRESSED, IMPLIED, OR STATUTORY, INCLUDING ANY WARRANTY OF MERCHANTABILITY OR FITNESS FOR ANY PARTICULAR PURPOSE. EXCEPT TO THE EXTENT OF THIS INDEMNITY, NEITHER PARTY SHALL BE LIABLE TO THE OTHER FOR ANY INDIRECT, SPECIAL, INCIDENTAL, OR CONSEQUENTIAL DAMAGES.**

The user assumes all responsibility and liability for proper and safe handling of the goods. Further, the user releases LTC from all claims arising from the handling or use of the goods. Due to the open construction of the product, it is the user's responsibility to take any and all appropriate precautions with regard to electrostatic discharge. Also be aware that the products herein may not be regulatory compliant or agency certified (FCC, UL, CE, etc.).

No License is granted under any patent right or other intellectual property whatsoever. **LTC assumes no liability for applications assistance, customer product design, software performance, or infringement of patents or any other intellectual property rights of any kind.**

LTC currently services a variety of customers for products around the world, and therefore this transaction **is not exclusive**.

Please read the DEMO BOARD manual prior to handling the product. Persons handling this product must have electronics training and observe good laboratory practice standards. **Common sense is encouraged.**

This notice contains important safety information about temperatures and voltages. For further safety concerns, please contact a LTC application engineer.

Mailing Address:

Linear Technology
1630 McCarthy Blvd.
Milpitas, CA 95035

Copyright © 2004, Linear Technology Corporation