

# Control Integrated POver System (CIPOS™)

IKCM10H60HA

Datasheet

## Table of contents

Table of contents .....	2
<b>CIPOS™ Control Integrated POver System .....</b>	<b>3</b>
Features .....	3
Target Applications.....	3
Description .....	3
System Configuration .....	3
<b>Pin Configuration.....</b>	<b>4</b>
<b>Internal Electrical Schematic.....</b>	<b>4</b>
<b>Pin Assignment .....</b>	<b>5</b>
<b>Pin Description .....</b>	<b>5</b>
HIN(U, V, W) and LIN(U, V, W) (Low side and high side control pins, Pin 7 - 12).....	5
VFO (Fault-output, Pin 14) .....	6
ITRIP (Over current detection function, Pin 15).....	6
VDD, VSS (Low side control supply and reference, Pin 13, 16) .....	6
VB(U, V, W) and VS(U, V, W) (High side supplies, Pin 1 - 6).....	6
NW, NV, NU (Low side emitter, Pin 17 - 19) .....	6
W, V, U (High side emitter and low side collector, Pin 20 - 22) .....	6
P (Positive bus input voltage, Pin 23).....	6
<b>Absolute Maximum Ratings .....</b>	<b>7</b>
Module Section .....	7
Inverter Section.....	7
Control Section .....	7
<b>Recommended Operation Conditions .....</b>	<b>8</b>
<b>Static Parameters .....</b>	<b>9</b>
<b>Dynamic Parameters .....</b>	<b>10</b>
<b>Bootstrap Parameters .....</b>	<b>10</b>
<b>Mechanical Characteristics and Ratings .....</b>	<b>11</b>
<b>Switching Times Definition .....</b>	<b>11</b>
<b>Circuit of a Typical Application .....</b>	<b>12</b>
<b>Electrical characteristic .....</b>	<b>13</b>
<b>Package Outline.....</b>	<b>14</b>
<b>Revision history .....</b>	<b>15</b>

# CIPOS™

## Control Integrated Power System

*Dual In-Line Intelligent Power Module*  
*3Φ-bridge 600V / 10A*

### Features

Fully isolated Dual In-Line molded module

- TRENCHSTOP™ IGBTs
- Rugged SOI gate driver technology with stability against transient and negative voltage
- 0.5μs minimum deadtime
- 0.5μs on/off pulse width response possible
- On/off matched delay time to all 6 driver outputs
- Allowable negative VS potential up to -11V for signal transmission at VBS=15V
- Integrated bootstrap functionality
- Over current shutdown
- Under-voltage lockout at all channels
- Low side emitter pins accessible for all phase current monitoring (open emitter)
- Cross-conduction prevention
- All of 6 switches turn off during protection
- Lead-free terminal plating; RoHS compliant

### Target Applications

- Washing machines
- Fans
- Low power motor drives

### Description

The CIPOS™ module family offers the chance for integrating various power and control components to increase reliability, optimize PCB size and system costs.

It is designed to control three phase AC motors and permanent magnet motors in variable speed drives for high switching frequency applications (around 15kHz) like a washing machine due to very low turn-off switching loss. The package concept is specially adapted to power applications, which need good thermal conduction and electrical isolation, but also EMI-save control and overload protection.

TRENCHSTOP™ IGBTs and anti parallel diodes are combined with an optimized SOI gate driver for excellent electrical performance.

### System Configuration

- 3 half bridges with TRENCHSTOP™ IGBTs and anti parallel diodes
- 3Φ SOI gate driver
- Pin-to-heatsink clearance distance typ. 1.6mm

## Pin Configuration

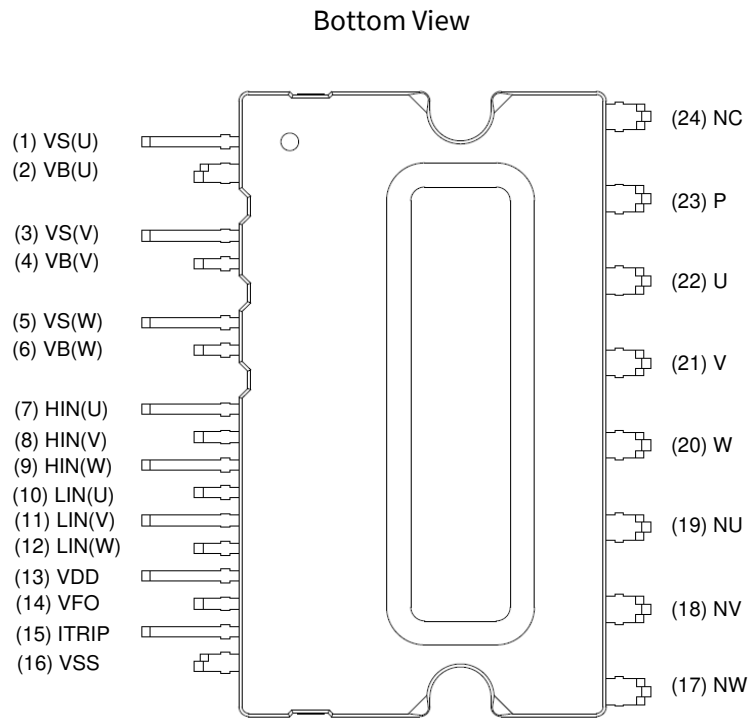

Figure 1 Pin configuration

## Internal Electrical Schematic

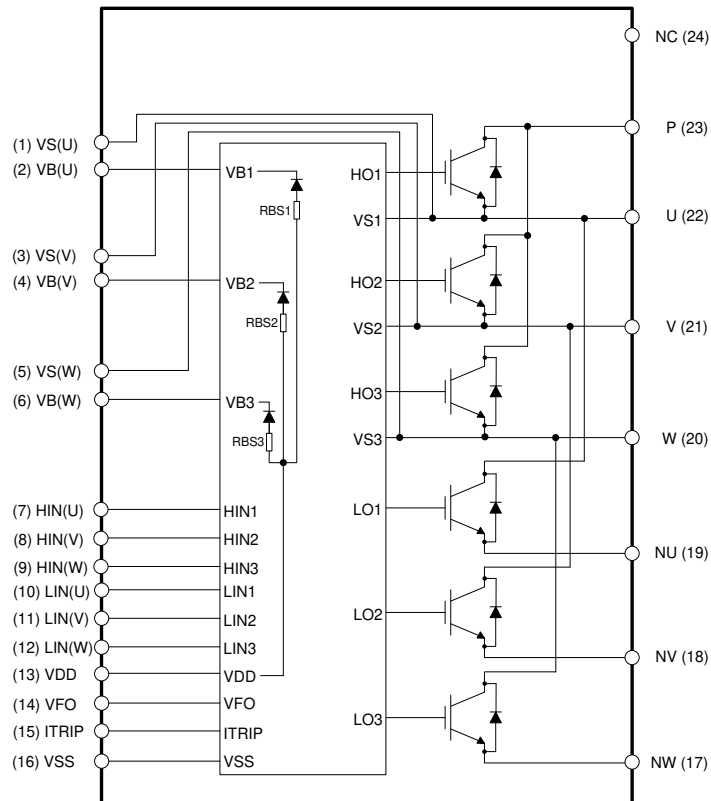

Figure 2 Internal schematic

## Pin Assignment

Pin Number	Pin Name	Pin Description
1	VS(U)	U-phase high side floating IC supply offset voltage
2	VB(U)	U-phase high side floating IC supply voltage
3	VS(V)	V-phase high side floating IC supply offset voltage
4	VB(V)	V-phase high side floating IC supply voltage
5	VS(W)	W-phase high side floating IC supply offset voltage
6	VB(W)	W-phase high side floating IC supply voltage
7	HIN(U)	U-phase high side gate driver input
8	HIN(V)	V-phase high side gate driver input
9	HIN(W)	W-phase high side gate driver input
10	LIN(U)	U-phase low side gate driver input
11	LIN(V)	V-phase low side gate driver input
12	LIN(W)	W-phase low side gate driver input
13	VDD	Low side control supply
14	VFO	Fault output
15	ITRIP	Over current shutdown input
16	VSS	Low side control negative supply
17	NW	W-phase low side emitter
18	NV	V-phase low side emitter
19	NU	U-phase low side emitter
20	W	Motor W-phase output
21	V	Motor V-phase output
22	U	Motor U-phase output
23	P	Positive bus input voltage
24	NC	No Connection

## Pin Description

### HIN(U, V, W) and LIN(U, V, W) (Low side and high side control pins, Pin 7 - 12)

These pins are positive logic and they are responsible for the control of the integrated IGBT. The Schmitt-trigger input thresholds of them are such to guarantee LSTTL and CMOS compatibility down to 3.3V controller outputs. Pull-down resistor of about 5kΩ is internally provided to pre-bias inputs during supply start-up and a zener clamp is provided for pin protection purposes. Input Schmitt-trigger and noise filter provide beneficial noise rejection to short input pulses.

The noise filter suppresses control pulses which are below the filter time  $t_{FILIN}$ . The filter acts according to Figure 4.

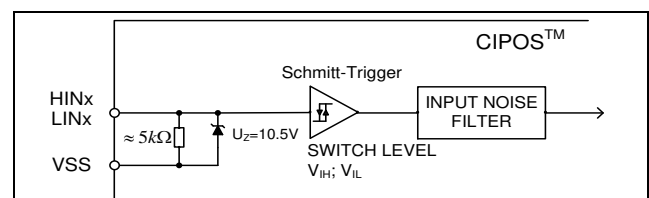

Figure 3 Input pin structure

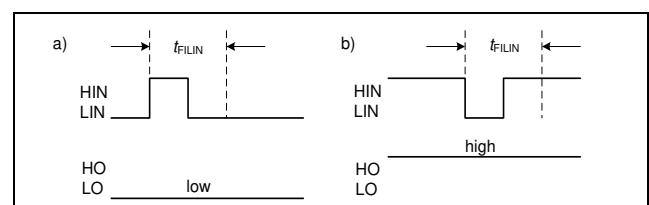

Figure 4 Input filter timing diagram

It is not recommended for proper work to provide input pulse-width lower than 0.5µs.

The integrated gate drive provides additionally a shoot through prevention capability which avoids the simultaneous on-state of two gate drivers of the same leg (i.e. HO1 and LO1, HO2 and LO2, HO3 and LO3). When two inputs of a same leg are activated, only former activated one is activated so that the leg is kept steadily in a safe state.

A minimum deadtime insertion of typically 380ns is also provided by driver IC, in order to reduce cross-conduction of the external power switches.

**VFO (Fault-output, Pin 14)**

The VFO pin indicates a module failure in case of under voltage at pin VDD or in case of triggered over current detection at ITRIP. A pull-up resistor is externally required.

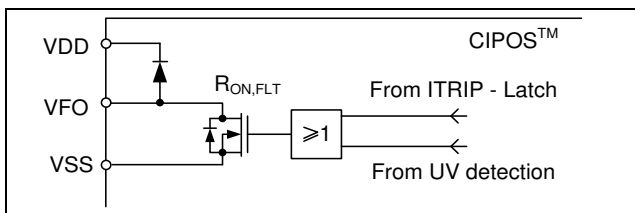

Figure 5 Internal circuit at pin VFO

**ITRIP (Over current detection function, Pin 15)**

CIPOS™ provides an over current detection function by connecting the ITRIP input with the IGBT collector current feedback. The ITRIP comparator threshold (typ. 0.47V) is referenced to VSS ground. An input noise filter (typ.:  $t_{ITRIPMIN} = 530ns$ ) prevents the driver to detect false over-current events.

Over current detection generates a shutdown of all outputs of the gate driver after the shutdown propagation delay of typically 1000ns.

The fault-clear time is set to minimum 40µs.

**VDD, VSS (Low side control supply and reference, Pin 13, 16)**

VDD is the control supply and it provides power both to input logic and to output power stage. Input logic is referenced to VSS ground.

The under-voltage circuit enables the device to operate at power on when a supply voltage of at least a typical voltage of  $V_{DDUV+} = 12.1V$  is present.

The IC shuts down all the gate drivers power outputs, when the VDD supply voltage is below  $V_{DDUV-} = 10.4V$ . This prevents the external power switches from critically low gate voltage levels during on-state and therefore from excessive power dissipation.

**VB(U, V, W) and VS(U, V, W) (High side supplies, Pin 1 - 6)**

VB to VS is the high side supply voltage. The high side circuit can float with respect to VSS following the external high side power device emitter voltage.

Due to the low power consumption, the floating driver stage is supplied by integrated bootstrap circuit.

The under-voltage detection operates with a rising supply threshold of typical  $V_{BSUV+} = 12.1V$  and a falling threshold of  $V_{BSUV-} = 10.4V$ .

VS(U, V, W) provide a high robustness against negative voltage in respect of VSS of -50V transiently. This ensures very stable designs even under rough conditions.

**NW, NV, NU (Low side emitter, Pin 17 - 19)**

The low side emitters are available for current measurements of each phase leg. It is recommended to keep the connection to pin VSS as short as possible in order to avoid unnecessary inductive voltage drops.

**W, V, U (High side emitter and low side collector, Pin 20 - 22)**

These pins are motor U, V, W input pins.

**P (Positive bus input voltage, Pin 23)**

The high side IGBTs are connected to the bus voltage. It is noted that the bus voltage does not exceed 450V.

## Absolute Maximum Ratings

( $V_{DD} = 15V$  and  $T_J = 25^\circ C$ , if not stated otherwise)

### Module Section

Description	Condition	Symbol	Value		Unit
			min	max	
Storage temperature range		$T_{stg}$	-40	125	$^\circ C$
Isolation test voltage	RMS, $f = 60Hz$ , $t = 1min$	$V_{ISOL}$	2000	-	V
Operating case temperature range	Refer to Figure 6	$T_C$	-40	125	$^\circ C$

### Inverter Section

Description	Condition	Symbol	Value		Unit
			min	max	
Max. blocking voltage	$I_C = 250\mu A$	$V_{CES}$	600	-	V
DC link supply voltage of P-N	Applied between P-N	$V_{PN}$	-	450	V
DC link supply voltage (surge) of P-N	Applied between P-N	$V_{PN(surge)}$	-	500	V
Output current	$T_C = 25^\circ C, T_J < 150^\circ C$ $T_C = 80^\circ C, T_J < 150^\circ C$	$I_C$	-10 -6	10 6	A
Maximum peak output current	less than 1ms	$I_{C(peak)}$	-16	16	A
Short circuit withstand time <sup>1</sup>	$V_{DC} \leq 400V, T_J = 150^\circ C$	$t_{SC}$	-	5	$\mu s$
Power dissipation per IGBT		$P_{tot}$	-	23.1	W
Operating junction temperature range		$T_J$	-40	150	$^\circ C$
Single IGBT thermal resistance, junction-case		$R_{thJC}$	-	5.42	K/W
Single diode thermal resistance, junction-case		$R_{thJCD}$	-	6.88	K/W

### Control Section

Description	Condition	Symbol	Value		Unit
			min	max	
Module supply voltage		$V_{DD}$	-1	20	V
High side floating supply voltage (VB vs. VS)		$V_{BS}$	-1	20	V
Input voltage	LIN, HIN, ITRIP	$V_{IN}$ $V_{ITRIP}$	-1 -1	10 10	V
Switching frequency		$f_{PWM}$	-	20	kHz

<sup>1</sup> Allowed number of short circuits: <1000; time between short circuits: >1s.

## Recommended Operation Conditions

All voltages are absolute voltages referenced to  $V_{SS}$  -potential unless otherwise specified.

Description	Symbol	Value			Unit
		min	typ	max	
DC link supply voltage of P-N	$V_{PN}$	0	-	450	V
High side floating supply voltage ( $V_B$ vs. $V_S$ )	$V_{BS}$	13.5	-	18.5	V
Low side supply voltage	$V_{DD}$	14.5	16	18.5	V
Control supply variation	$\Delta V_{BS}$	-1	-	1	V/ $\mu$ s
	$\Delta V_{DD}$	-1	-	1	
Logic input voltages LIN, HIN, ITRIP	$V_{IN}$	0	-	5	V
	$V_{ITRIP}$	0	-	5	
Between $V_{SS}$ - N (including surge)	$V_{SS}$	-5	-	5	V

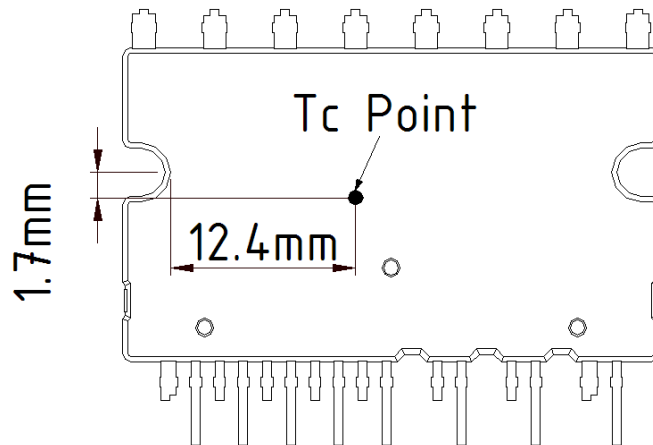

Figure 6  $T_c$  measurement point<sup>1</sup>

<sup>1</sup>Any measurement except for the specified point in figure 6 is not relevant for the temperature verification and brings wrong or different information.



## Static Parameters

( $V_{DD} = 15V$  and  $T_J = 25^\circ C$ , if not stated otherwise)

Description	Condition	Symbol	Value			Unit
			min	typ	max	
Collector-Emitter saturation voltage	$I_C = 6A$ $T_J = 25^\circ C$ $150^\circ C$	$V_{CE(sat)}$	- -	1.8 2.3	2.6 -	V
Diode forward voltage	$I_F = 6A$ $T_J = 25^\circ C$ $150^\circ C$	$V_F$	- -	1.75 1.8	2.35 -	V
Collector-Emitter leakage current	$V_{CE} = 600V$	$I_{CES}$	-	-	1	mA
Logic "1" input voltage (LIN, HIN)		$V_{IH}$	-	2.1	2.5	V
Logic "0" input voltage (LIN, HIN)		$V_{IL}$	0.7	0.9	-	V
ITRIP positive going threshold		$V_{IT,TH+}$	400	470	540	mV
ITRIP input hysteresis		$V_{IT,HYS}$	40	70	-	mV
VDD and VBS supply under voltage positive going threshold		$V_{DDUV+}$ $V_{BSUV+}$	10.8	12.1	13.0	V
VDD and VBS supply under voltage negative going threshold		$V_{DDUV-}$ $V_{BSUV-}$	9.5	10.4	11.2	V
VDD and VBS supply under voltage lockout hysteresis		$V_{DDUVH}$ $V_{BSUVH}$	1.0	1.7	-	V
Input clamp voltage (HIN, LIN, ITRIP)	$I_{in} = 4mA$	$V_{INCLAMP}$	9.0	10.1	12.5	V
Quiescent $V_{Bx}$ supply current ( $V_{Bx}$ only)	$H_{IN} = 0V$	$I_{QBS}$	-	300	500	$\mu A$
Quiescent VDD supply current (VDD only)	$L_{IN} = 0V, H_{INX} = 5V$	$I_{QDD}$	-	370	900	$\mu A$
Input bias current	$V_{IN} = 5V$	$I_{IN+}$	-	1	1.5	mA
Input bias current	$V_{IN} = 0V$	$I_{IN-}$	-	2	-	$\mu A$
ITRIP input bias current	$V_{ITRIP} = 5V$	$I_{ITRIP+}$	-	65	150	$\mu A$
VFO input bias current	$VFO = 5V, V_{ITRIP} = 0V$	$I_{FO}$	-	2	-	nA
VFO output voltage	$I_{FO} = 10mA, V_{ITRIP} = 1V$	$V_{FO}$	-	0.5	-	V

## Dynamic Parameters

( $V_{DD} = 15V$  and  $T_J = 25^\circ C$ , if not stated otherwise)

Description	Condition	Symbol	Value			Unit
			min	typ	max	
Turn-on propagation delay time	$V_{LIN, HIN} = 5V,$ $I_C = 6A,$ $V_{DC} = 300V$	$t_{on}$	-	600	-	ns
Turn-on rise time		$t_r$	-	15	-	ns
Turn-on switching time		$t_{c(on)}$	-	80	-	ns
Reverse recovery time		$t_{rr}$	-	90	-	ns
Turn-off propagation delay time	$V_{LIN, HIN} = 0V,$ $I_C = 6A,$ $V_{DC} = 300V$	$t_{off}$	-	770	-	ns
Turn-off fall time		$t_f$	-	90	-	ns
Turn-off switching time		$t_{c(off)}$	-	125	-	ns
Short circuit propagation delay time	From $V_{IT, TH+}$ to 10% $I_{SC}$	$t_{SCP}$	-	1200	-	ns
Input filter time ITRIP	$V_{ITRIP} = 1V$	$t_{ITRIPmin}$	-	530	-	ns
Input filter time at LIN, HIN for turn on and off	$V_{LIN, HIN} = 0V \& 5V$	$t_{FILIN}$	-	290	-	ns
Fault clear time after ITRIP-fault	$V_{ITRIP} = 1V$	$t_{FLTCLR}$	40	65	200	$\mu s$
Deadtime between low side and high side		$DT_{PWM}$	0.5	-	-	$\mu s$
Deadtime of gate drive circuit		$DT_{IC}$	-	380	-	ns
IGBT turn-on energy (includes reverse recovery of diode)	$V_{DC} = 300V, I_C = 6A$ $T_J = 25^\circ C$ $150^\circ C$	$E_{on}$	-	95	-	$\mu J$
			-	135	-	
IGBT turn-off energy	$V_{DC} = 300V, I_C = 6A$ $T_J = 25^\circ C$ $150^\circ C$	$E_{off}$	-	95	-	$\mu J$
			-	135	-	
Diode recovery energy	$V_{DC} = 300V, I_C = 6A$ $T_J = 25^\circ C$ $150^\circ C$	$E_{rec}$	-	25	-	$\mu J$
			-	50	-	

## Bootstrap Parameters

( $T_J = 25^\circ C$ , if not stated otherwise)

Description	Condition	Symbol	Value			Unit
			min	typ	max	
Repetitive peak reverse voltage		$V_{RRM}$	600	-	-	V
Bootstrap diode resistance of U-phase <sup>1</sup>	$VS2$ or $VS3 = 300V, T_J = 25^\circ C$	$R_{BS1}$	-	35	-	$\Omega$
	$VS2$ and $VS3 = 0V, T_J = 25^\circ C$			40		
	$VS2$ or $VS3 = 300V, T_J = 125^\circ C$			50		
	$VS2$ and $VS3 = 0V, T_J = 125^\circ C$			65		
Reverse recovery time	$I_F = 0.6A, di/dt = 80A/\mu s$	$t_{rr\_BS}$	-	50	-	ns
Forward voltage drop	$I_F = 20mA, VS2$ and $VS3 = 0V$	$V_{F\_BS}$	-	2.6	-	V

<sup>1</sup>  $R_{BS2}$  and  $R_{BS3}$  have same values to  $R_{BS1}$ .

## Mechanical Characteristics and Ratings

Description	Condition	Value			Unit
		min	typ	max	
Mounting torque	M3 screw and washer	0.59	0.69	0.78	Nm
Flatness	Refer to Figure 7	-50	-	100	μm
Weight		-	6.15	-	g

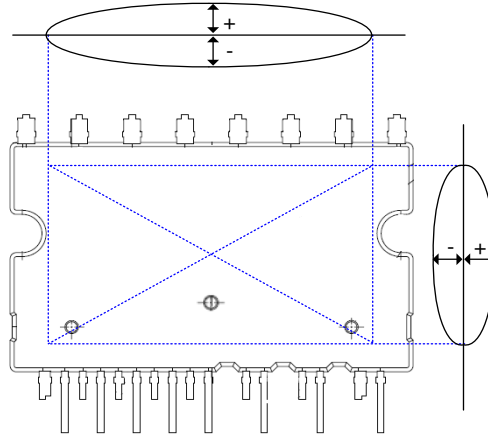

Figure 7 Flatness measurement position

## Switching Times Definition

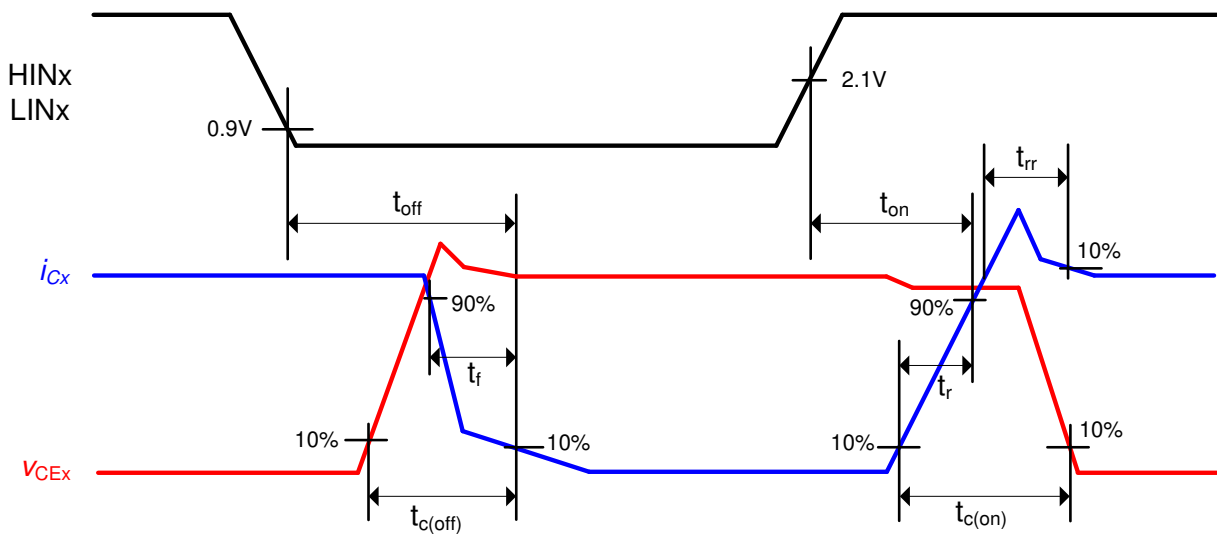
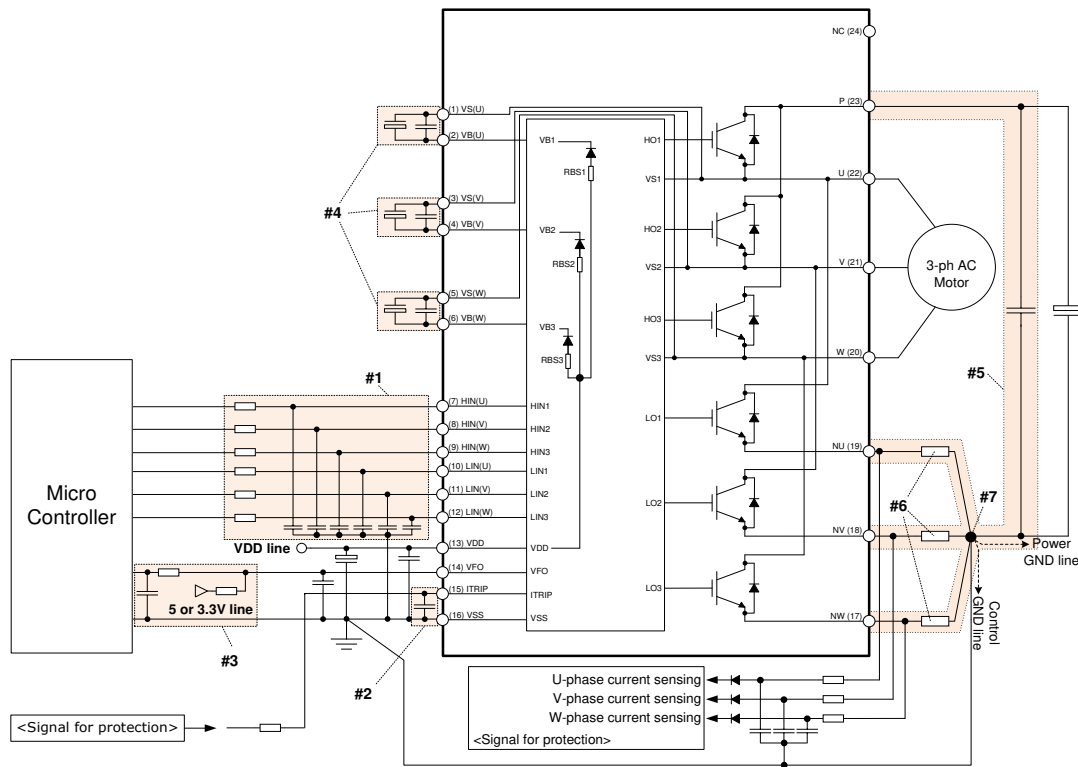

Figure 8 Switching times definition

## Circuit of a Typical Application



**Figure 9** Typical application circuit

### 1. Input circuit

- To reduce input signal noise by high speed switching, the  $R_{IN}$  and  $C_{IN}$  filter circuit should be mounted. ( $100\Omega$ ,  $1nF$ )
- $C_{IN}$  should be placed as close to  $V_{SS}$  pin as possible.

### 2. Itrip circuit

- To prevent protection function errors,  $C_{ITRIP}$  should be placed as close to Itrip and  $V_{SS}$  pins as possible.

### 3. VFO circuit

- VFO output is an open drain output. This signal line should be pulled up to the positive side of the 5V/3.3V logic power supply with a proper resistor  $R_{PU}$ .
- It is recommended that RC filter be placed as close to the controller as possible.

### 4. VB-VS circuit

- Capacitor for high side floating supply voltage should be placed as close to VB and VS pins as possible.

### 5. Snubber capacitor

- The wiring between CIPOS™ Mini and snubber capacitor including shunt resistor should be as short as possible.

### 6. Shunt resistor

- The shunt resistor of SMD type should be used for reducing its stray inductance.

### 7. Ground pattern

- Ground pattern should be separated at only one point of shunt resistor as short as possible.

## Electrical characteristic

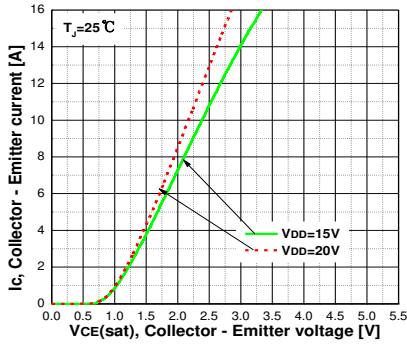

Typ. Collector - Emitter saturation voltage

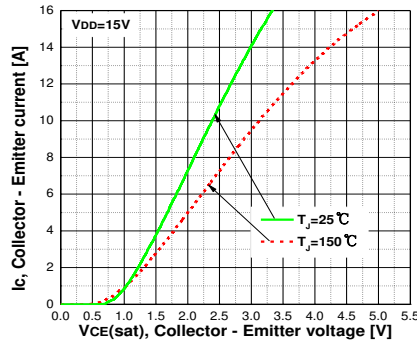

Typ. Collector - Emitter saturation voltage

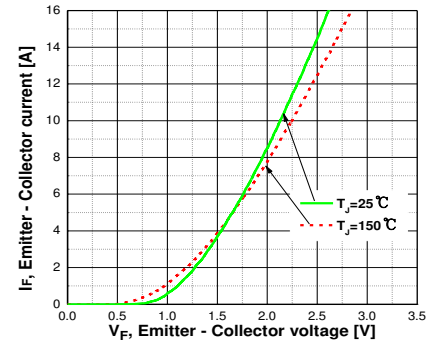

Typ. Diode forward voltage

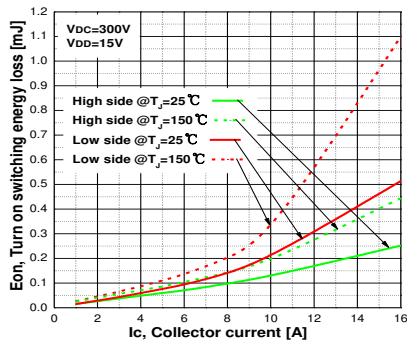

Typ. Turn on switching energy loss

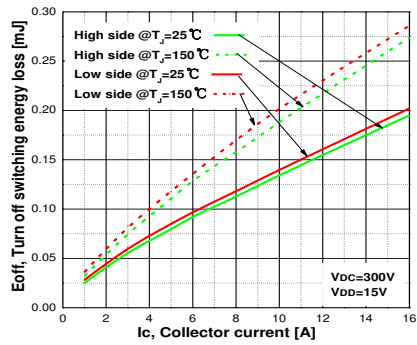

Typ. Turn off switching energy loss

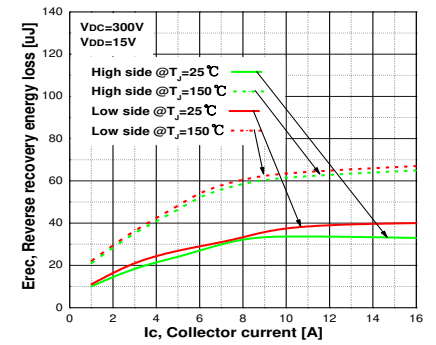

Typ. Reverse recovery energy loss

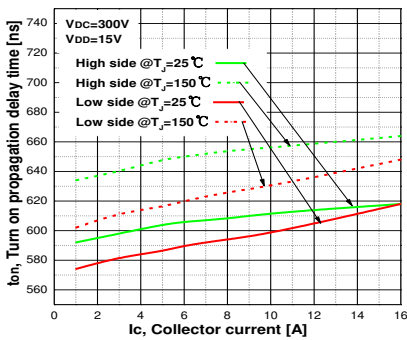

Typ. Turn on propagation delay time

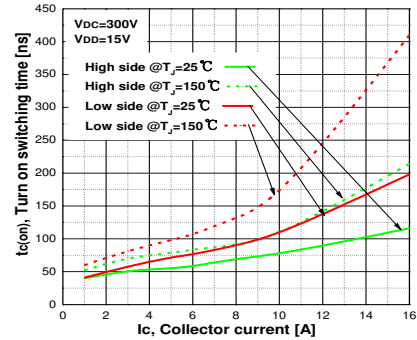

Typ. Turn on switching time

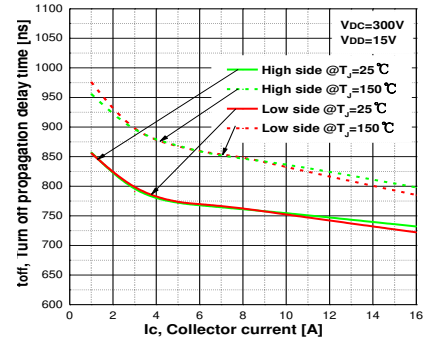

Typ. Turn off propagation delay time

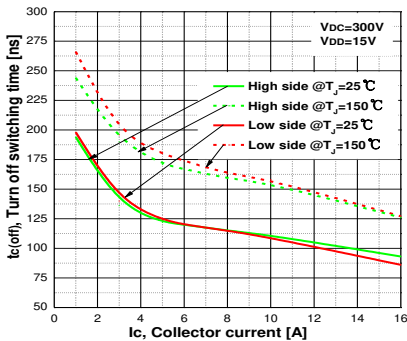

Typ. Turn off switching time

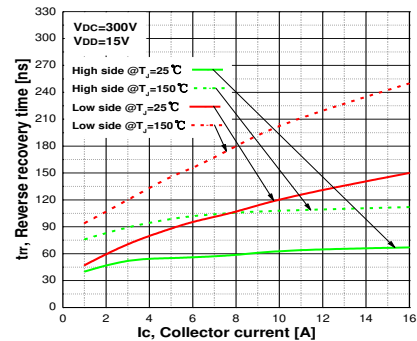

Typ. Reverse recovery time

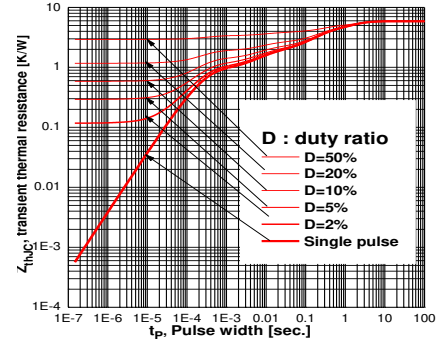

IGBT transient thermal resistance at all six IGBTs operation

## Package Outline

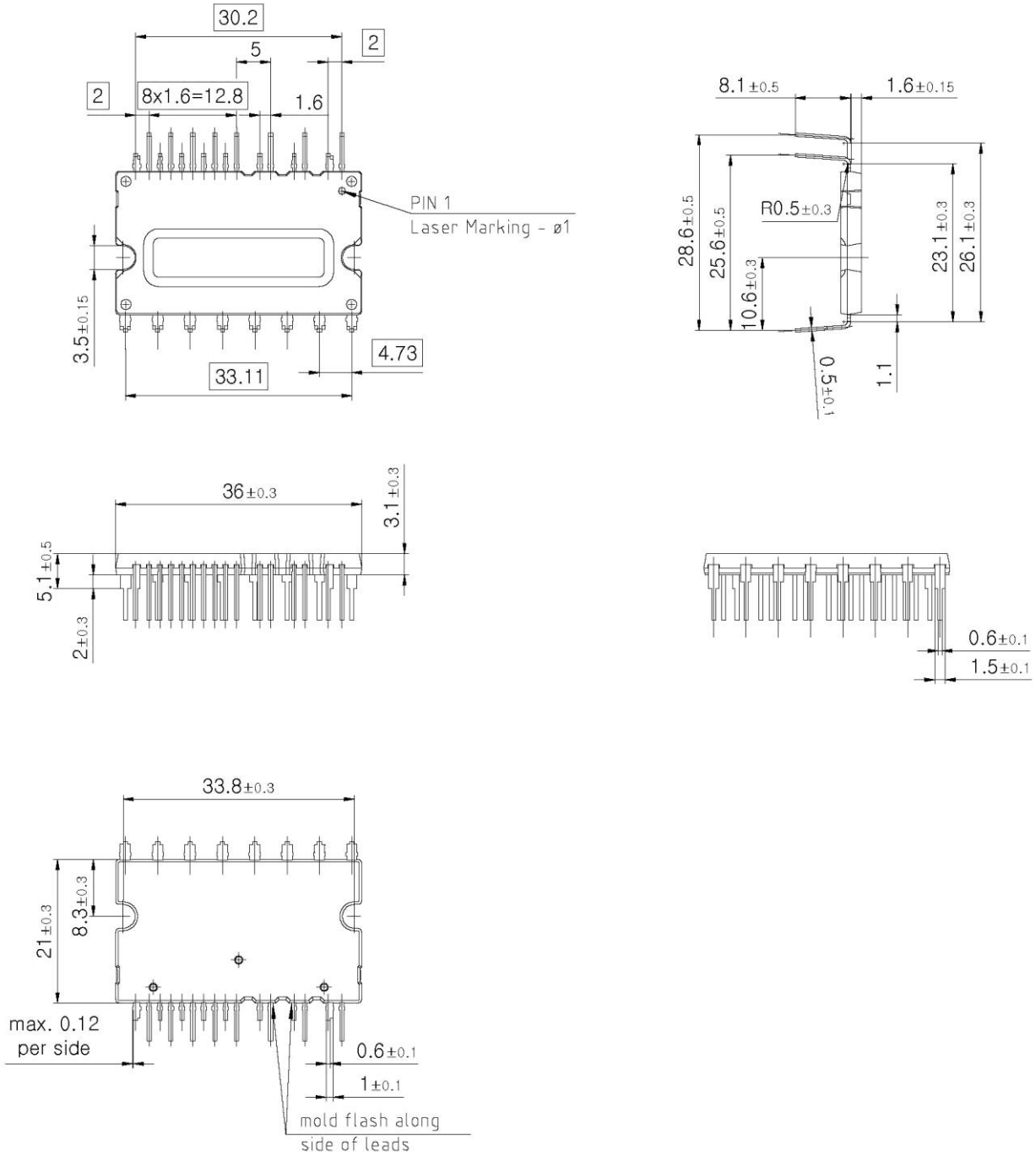

## Revision history

Document version	Date of release	Description of changes
V 2.4	Sep. 2017	Maximum operating case temperature, Tc= 125°C Package outline update

## Trademarks

All referenced product or service names and trademarks are the property of their respective owners.

**Edition 2017-09-06**

**Published by**

**Infineon Technologies AG**

**81726 München, Germany**

**© 2017 Infineon Technologies AG.**

**All Rights Reserved.**

**Do you have a question about this document?**

**Email: [erratum@infineon.com](mailto:erratum@infineon.com)**

**Document reference**

**ifx1**

## IMPORTANT NOTICE

The information given in this document shall in no event be regarded as a guarantee of conditions or characteristics ("Beschaffenheitsgarantie").

With respect to any examples, hints or any typical values stated herein and/or any information regarding the application of the product, Infineon Technologies hereby disclaims any and all warranties and liabilities of any kind, including without limitation warranties of non-infringement of intellectual property rights of any third party.

In addition, any information given in this document is subject to customer's compliance with its obligations stated in this document and any applicable legal requirements, norms and standards concerning customer's products and any use of the product of Infineon Technologies in customer's applications.

The data contained in this document is exclusively intended for technically trained staff. It is the responsibility of customer's technical departments to evaluate the suitability of the product for the intended application and the completeness of the product information given in this document with respect to such application.

For further information on the product, technology, delivery terms and conditions and prices please contact your nearest Infineon Technologies office ([www.infineon.com](http://www.infineon.com)).

Please note that this product is not qualified according to the AEC Q100 or AEC Q101 documents of the Automotive Electronics Council.

## WARNINGS

Due to technical requirements products may contain dangerous substances. For information on the types in question please contact your nearest Infineon Technologies office.

Except as otherwise explicitly approved by Infineon Technologies in a written document signed by authorized representatives of Infineon Technologies, Infineon Technologies' products may not be used in any applications where a failure of the product or any consequences of the use thereof can reasonably be expected to result in personal injury.