Hysteretic Buck High Brightness LED Driver with Internal Switch

UM1360Y SOT89-5

General Description

The UM1360 is a PWM step-down converter with internal power switch, designed for driving single or multiple series connected LEDs efficiently from a voltage source higher than the LED voltage. The UM1360 can drive up to 10 series connected LEDs. The device operates from an input supply between 6V and 40V and employs hysteretic control with a high side current sense resistor to set the constant output current up to 1A. The device is well suited for applications requiring a wide input range. The high side current sensing and an integrated current sensing circuitry minimize the number of external components while delivering an accurate average output current. Depending upon supply voltage and external components, this device can provide up to 30 watts of output power.

Output current can be adjusted below the set value, by applying an external control signal to the VSET pin. The VSET pin will accept either a DC voltage or a PWM waveform. Dedicated pulse width modulation (PWM) input enables pulsed LED dimming over a wide range of brightness levels. A hysteretic control method ensures excellent input supply rejection and fast response during load transients and PWM dimming.

Applying a voltage of 0.2V or lower to the VSET pin turns the output off and switches the device into a low current standby state. The UM1360 employs spread spectrum technique to greatly reduce its interference to other part of the system.

The UM1360 comes in small SOT89-5 package. It is ideal for industrial and general lighting applications.

Applications

- Low Voltage Halogen Replacement LEDs
- Low Voltage Industrial Lighting
- LED Back-Side Lighting
- Illuminated Signs
- DC/DC or AC/DC LED Driver Application
- General Purpose, Constant Current Source

Features

- Hysteretic Control with High Side Current Sensing
- Integrated 40V 0.5Ω NDMOS
- Up to 98% Efficiency
- Wide Input Voltage Range: 6V to 40V
- 50V Transient Capability
- ± 5% LED Current Accuracy
- Adjustable Constant LED Current
- Single Pin On/Off and Brightness Control Using DC Voltage or PWM
- Spread Spectrum Driver
- Over Temperature, Open Circuit LED Protection
- Up to 1MHz Switching Frequency
- Pb-Free SOT89-5 Package

Pin Configurations

Top View

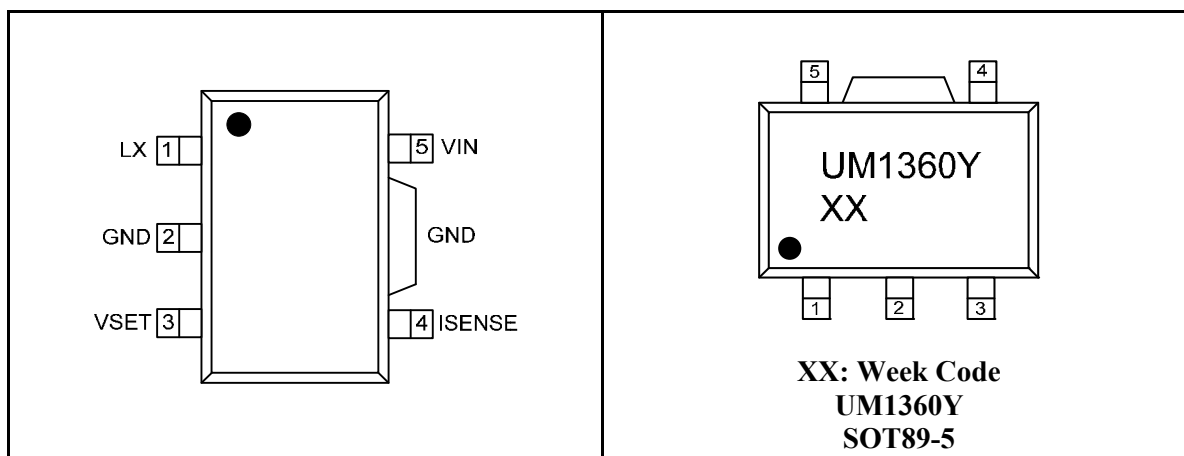

Ordering Information

Part Number	Packaging Type	Marking Code	Shipping Qty
UM1360Y	SOT89-5	UM1360Y	1000pcs/7Inch Tape & Reel

Pin Description

Pin Number	Symbol	Function
1	LX	Drain of NDMOS switch.
2	GND	Ground (0V).
3	VSET	Multi-function On/Off and brightness control pin: <ul style="list-style-type: none"> • Leave floating for normal operation. • Drive to voltage below 0.2V to turn off output current. • Drive with DC voltage ($0.3V < V_{SET} < 2.5V$) to adjust output current from 12% to 100% of I_{OUTnom}. • Drive with PWM signal to adjust output current. Adjustment range 1% to 100% of I_{OUTnom} for $f \leq 1kHz$.
4	ISENSE	Connect resistor R_S from this pin to VIN to define nominal average output current $I_{OUTnom} = 0.1/R_S$.
5	VIN	Input voltage (6V to 40V). Decouple to ground with 10 μ F or higher X7R ceramic capacitor close to device.

Absolute Maximum Ratings

Over operating free-air temperature (unless otherwise noted) (Note 1)

Symbol	Parameter	Value	Unit
V_{IN}	Input Voltage Range	-0.3 to +40	V
V_{LX} , V_{ISENSE}	Voltages on LX, ISENSE	-0.3 to +40	V
V_{SET}	VSET Pin Voltage	-0.3 to +6	V
θ_{JA}	Thermal Resistance (Junction to Ambient)	100	°C/W
T_J	Maximum Junction Temperature	+150	°C
T_{STG}	Storage Temperature Range	-55 to +150	°C
T_L	Maximum Lead Temperature for Soldering 5 Seconds	+300	°C

Note 1: These are stress ratings only and functional operation is not implied. Exposure to absolute maximum ratings for prolonged time periods may affect device reliability. All voltage values are with respect to network ground terminal.

Recommended Operating Conditions

Symbol	Parameter	Min	Typ	Max	Unit
V_{IN}	Input Voltage Range	6.0		40	V
T_A	Operating Ambient Temperature	-40		85	°C
T_J	Operating Junction Temperature	-40		150	°C

Electrical Characteristics

 ($V_{IN}=16V$, $T_A=25^{\circ}C$, unless otherwise noted)

Symbol	Parameter	Test Conditions	Min	Typ	Max	Unit
V_{IN}	Input Voltage Range		6		40	V
I_{LED}	Output Current	$R_S=0.33\Omega$		303		mA
		$R_S=0.1\Omega$		1000		
I_Q	Quiescent Current without Switching	VSET Pin Floating, $V_{IN}=16V$		430		μA
I_{SD}	Shutdown Current	VSET=GND, $V_{IN}=16V$		35	70	μA
V_{SENSE}	Mean Current Sense Threshold Voltage	Measured on ISENSE Pin with Respect to VIN	95	100	105	mV
V_{SENSE_HYS}	Sense Threshold Hysteresis			± 15		%
I_{SENSE}	ISENSE Pin Input Current	$V_{SENSE}=V_{IN}-0.1$		20		μA
V_{EN}	V_{SET} Range on VSET Pin	For DC Dimming	0.3		2.5	V
V_{ENON}	DC Voltage on VSET Pin to Enable	V_{EN} Rising		0.25		V
V_{ENOFF}	DC Voltage on VSET Pin to Disable	V_{EN} Falling		0.2		V
R_{LX}	LX Switch on Resistance	$I_{LX}=1000mA$		0.5		Ω
$I_{LX(leak)}$	LX Switch Leakage Current				5	μA
F_{LX}	Operating Frequency	$V_{IN}=16V$, $L1=47\mu H$, $V_{OUT}=9.6V$ (3 LEDs), $R_S=0.1\Omega$		230		kHz
F_{LXmax}	Recommended Maximum Switch Frequency			1.0		MHz
T_{on_rec} (Note 2)	Recommended Minimum Switch ON Time	For 4% Accuracy		500		ns
	Max Duty Cycle			100		%
D_{LX}	Recommended Duty Cycle Range		25		75	%
T_{PD} (Note 2)	Internal Comparator Propagation Delay			500		ns
T_{OTP}	Over Temperature Protection			150		$^{\circ}C$
T_{OTP_HYS}	Temperature Protection Hysteresis			40		$^{\circ}C$
I_{LXmax}	Peak Switch Current		1.5			A
I_{LXmean}	Continuous Switch Current				1.0	A

Note 2: Parameters are not tested at production, but guaranteed by design.

Typical Operating Characteristics

Efficiency vs. V_{IN} ($L1=100\mu H$, $R_s=0.33\Omega$)

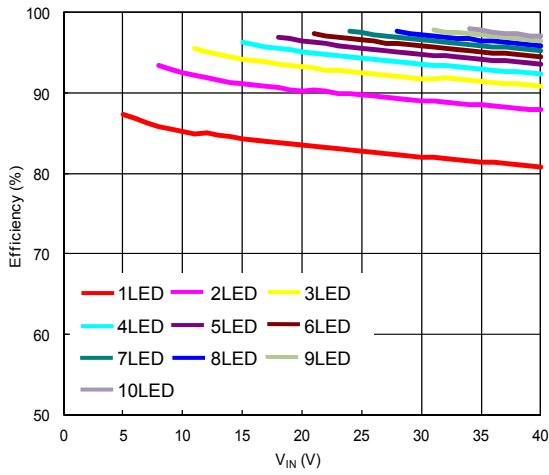

Efficiency vs. V_{IN} ($L1=47\mu H$, $R_s=0.15\Omega$)

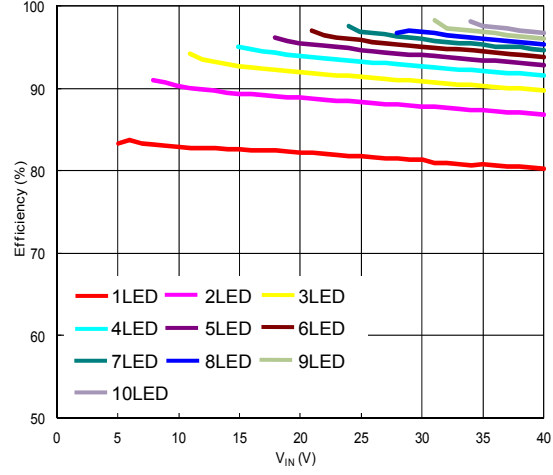

Efficiency vs. V_{IN} ($L1=33\mu H$, $R_s=0.1\Omega$)

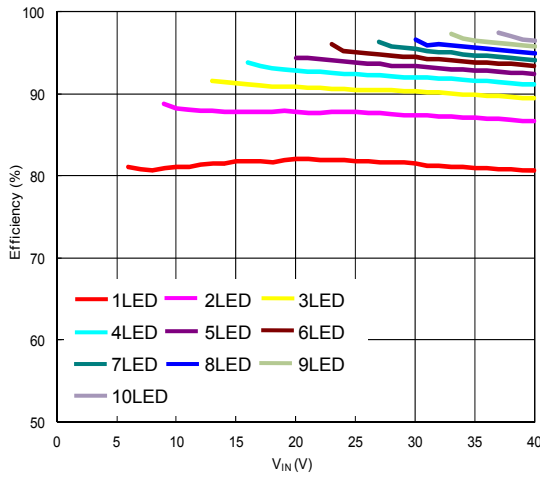

Output Current vs. V_{IN} ($L1=100\mu H$, $R_s=0.33\Omega$)

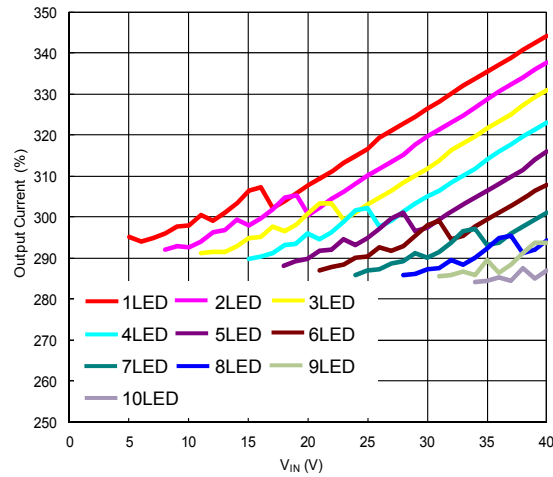

Quiescent Current vs. Input Voltage

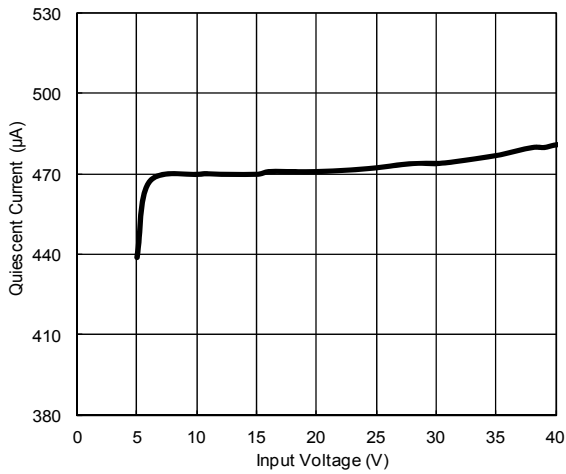

Shutdown Current vs. Input Voltage

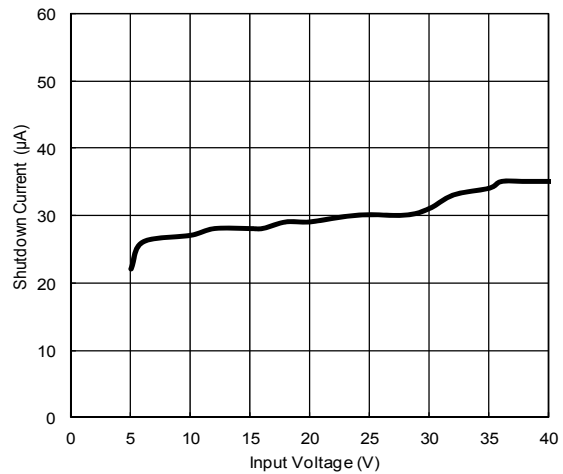

Typical Operating Characteristics (Continued)

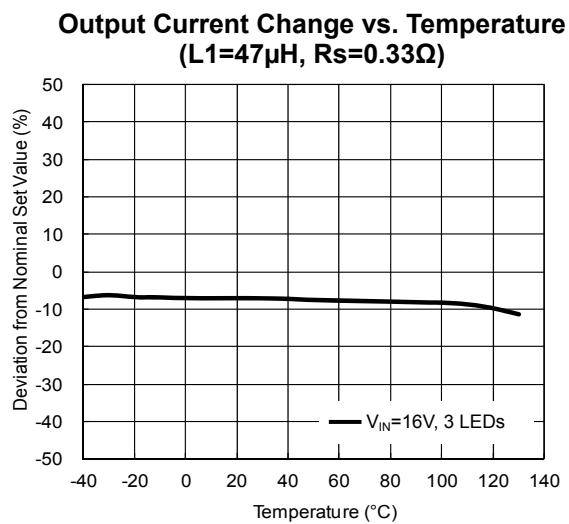
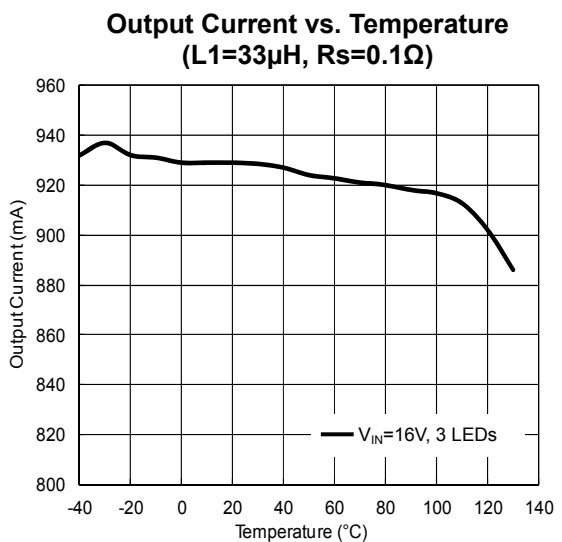
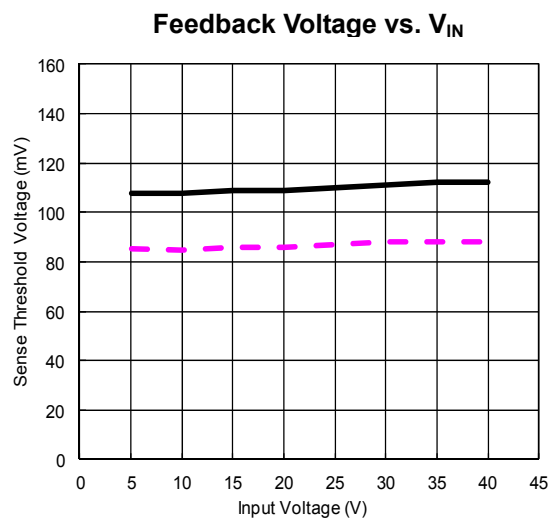
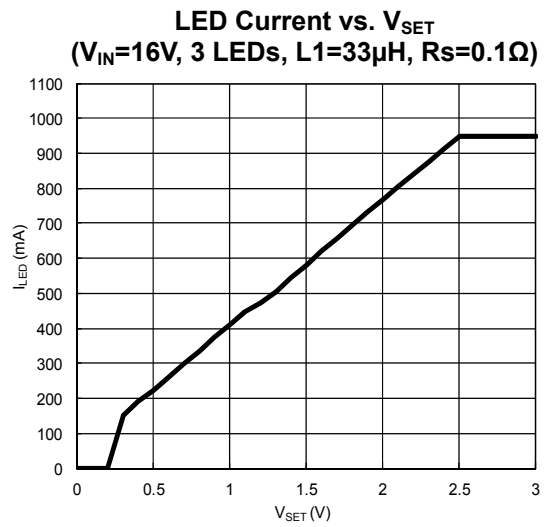
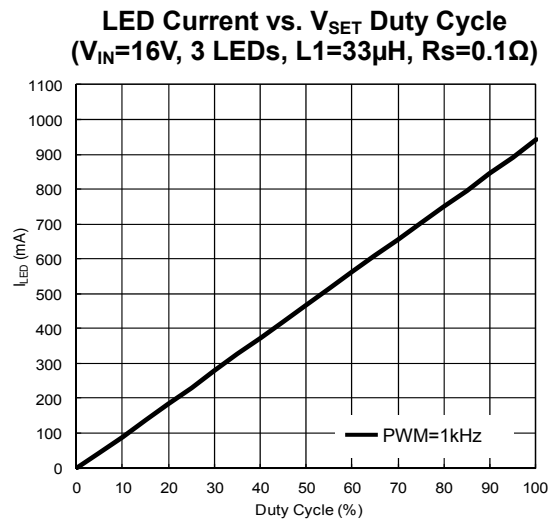

Typical Operating Characteristics (Continued)

Steady State Waveforms
($V_{IN}=16V$, 3 LEDs, $L1=100\mu H$, $R_s=0.33\Omega$)

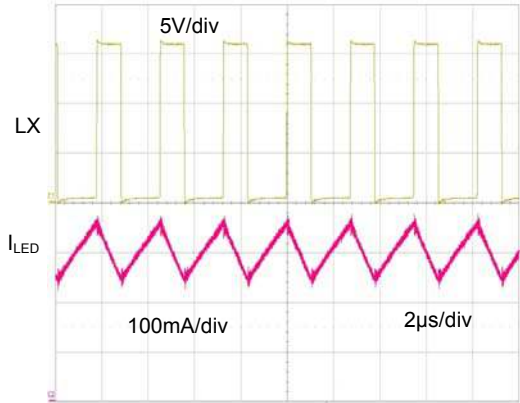

Start Up Waveforms

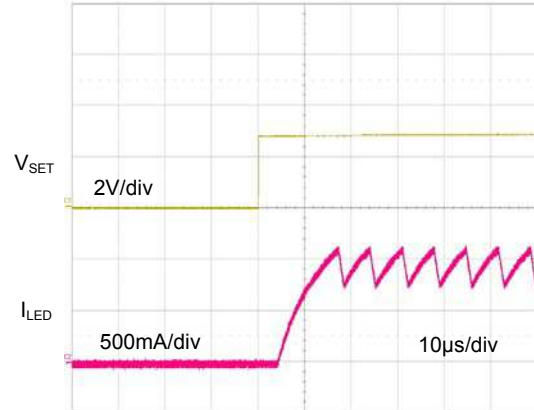

Dimming Waveforms
(PWM=50%, $V_{IN}=16V$, 3 LEDs, $L1=100\mu H$, $R_s=0.33\Omega$)

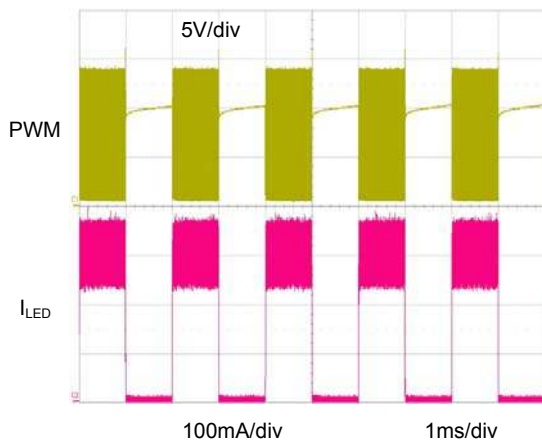

100% Duty Cycle Mode
($V_{IN}=10V$, 3 LEDs, $L1=100\mu H$, $R_s=0.33\Omega$)

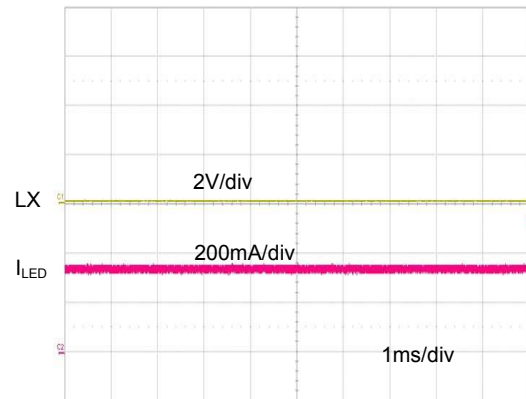

Hopping Switching Frequency Waveform Spectrum of the UM1360
($V_{IN}=16V$, 3 LEDs, $L1=100\mu H$, $I_{OUT}=1A$)

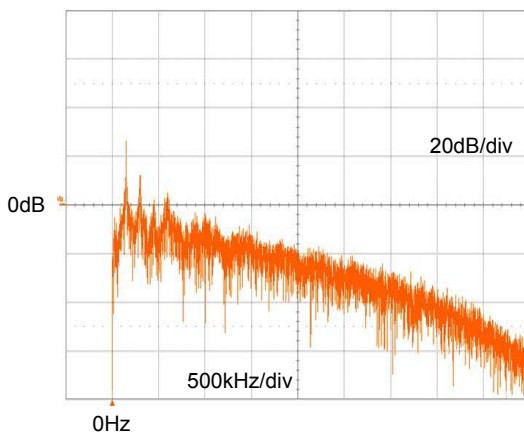

Fixed Switching Frequency Waveform Spectrum of Competitor
($V_{IN}=16V$, 3 LEDs, $L1=100\mu H$, $I_{OUT}=1A$)

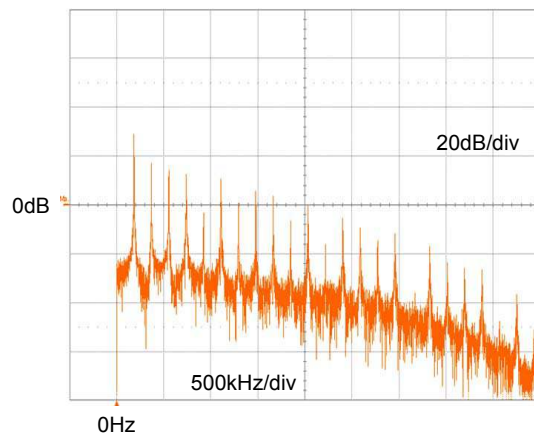

Applications Information

Setting Nominal Average Output Current with External Resistor R_S

The nominal average output current in the LED(s) is determined by the value of the external current sense resistor (R_S) connected between VIN and ISENSE and is given by:

$$I_{OUTnom} = 0.1/R_S \text{ [for } R_S \geq 0.1\Omega \text{]}$$

The table below gives values of nominal average output current for several preferred values of current setting resistor (R_S) in the typical application circuit as shown on page 5.

R_S (Ω)	Nominal Average Output Current (mA)
0.1	1000
0.13	760
0.15	667
0.3	333

The above values assume that the VSET pin is floating or applied with a voltage higher than 2.5V (must be less than 5V). Note that $R_S=0.1\Omega$ is the minimum allowed value of sense resistor under these conditions to maintain switch current below the specified maximum value. It is possible to use different values of R_S if the VSET pin is driven from an external voltage. (See next section).

Output Current Adjustment by External DC Control Voltage

The VSET pin can be driven by an external DC voltage (V_{EN}), as shown, to adjust the output current to a value below the nominal average value defined by R_S .

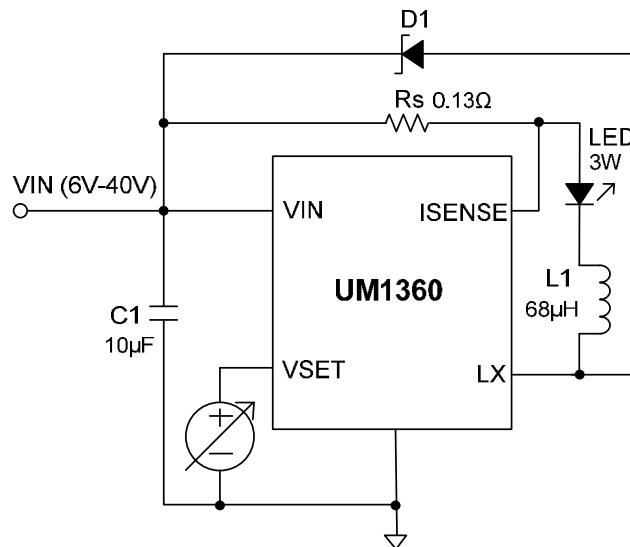

The average output current is given by:

$$I_{OUT} = (0.1 * V_{EN}) / (2.5 * R_S) \text{ [for } 0.3V < V_{EN} < 2.5V \text{]}$$

Note that 100% brightness setting corresponds to:
 $(2.5V \leq V_{EN} \leq 5V)$

Output Current Adjustment by PWM Control

A Pulse Width Modulated (PWM) signal with duty cycle PWM can be applied to the VSET pin, as shown below, to adjust the output current to a value below the nominal average value set by resistor R_S :

$$I_{OUT} = (0.1 * D) / R_S \quad (0 \leq D \leq 100\%, 2.5V < V_{pulse} < 5V)$$

$$I_{OUT} = (V_{pulse} * 0.1 * D) / (2.5 * R_S) \quad (0 \leq D \leq 100\%, 0.5V < V_{pulse} < 2.5V)$$

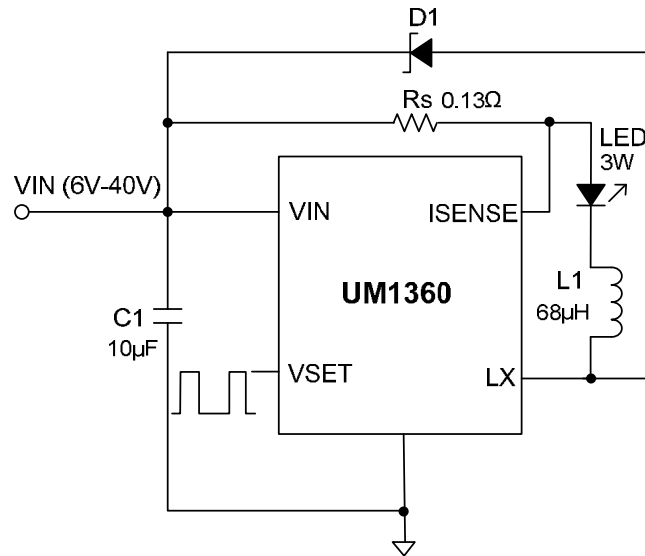

PWM dimming provides reduced brightness by modulating the LED's forward current between 0% and 100%. The LED brightness is controlled by adjusting the relative ratios of the on time to the off time. A 25% brightness level is achieved by turning the LED on at full current for 25% of one cycle. To ensure this switching process between on and off state is invisible by human eyes, the switching frequency must be greater than 100Hz. When above 100Hz, the human eyes average the on and off times, seeing only an effective brightness that is proportional to the LED's on-time duty cycle. The advantage of PWM dimming is that the forward current is always constant, therefore the LED color does not vary with brightness as it does with analog dimming. Pulsing the current provides precise brightness control while preserving the color purity.

Capacitor Selection

A low ESR capacitor should be used for input decoupling, as the ESR of this capacitor appears in series with the supply source impedance and lowers overall efficiency. This capacitor has to supply the relatively high peak current to the coil and smooth the current ripple on the input supply. A minimum value of 4.7µF is acceptable if the input source is close to the device, but higher values will improve performance at lower input voltages, especially when the source impedance is high. The input capacitor should be placed as close as possible to the IC.

For maximum stability over temperature and voltage, capacitors with X7R, X5R, or better dielectric are recommended. Capacitors with Y5V dielectric are not suitable for decoupling in this application and should NOT be used.

Inductor Selection

Recommended inductor values for the UM1360 are in the range 27µH to 220µH. Higher values of inductance are recommended at higher supply voltages in order to minimize errors due to switching delays, which result in increased ripple and lower efficiency. Higher values of inductance also result in a smaller change in output current over the supply voltage range.

The inductor should be mounted as close to the device as possible with low resistance connections to the LX and VIN pins. The chosen coil should have a saturation current higher than the peak output current and a continuous current rating above the required mean output current. Suitable coils for the UM1360 are listed in the table below:

Load Current	Inductor	Saturation Current
$I_{OUT} > 1A$	27-47 μ H	1.3-1.5 Times of Load Current
$0.8A < I_{OUT} \leq 1A$	33-82 μ H	
$0.4A < I_{OUT} \leq 0.8A$	47-100 μ H	
$I_{OUT} \leq 0.4A$	68-220 μ H	

Order Code	L(μ H)	Size	DCR (m Ω)	Saturation Current (mA)	Manufacturer
744066330	33	1038	92	1800	Würth Elektronik www.we-online.com
7447714470	47	1050	82.5	2.5	
7447714680	68	1050	110	2200	
7447714101	100	1050	165	1800	

The inductor value should be chosen to maintain operating duty cycle and switch 'on'/'off' times within the specified limits over the supply voltage and load current range. The following equations can be used as a guide.

LX Switch 'On' time

$$T_{ON} = (L1 * \Delta I) / (V_{IN} - V_{LED} - I_{LED} * (R_S + R_L + R_{LX}))$$

LX Switch 'Off' time

$$T_{OFF} = (L1 * \Delta I) / (V_{LED} + V_D + I_{LED} * (R_S + R_L))$$

Where:

L1 is the coil inductance (H).

R_L is the coil resistance (Ω).

R_S is the current sense resistance (Ω).

I_{LED} is the required LED current (A).

ΔI is the coil peak-peak ripple current (A) {internally set to $0.3 \times I_{LED}$ }.

V_{IN} is the supply voltage (V).

V_{LED} is the total LED forward voltage (V).

R_{LX} is the switch resistance (Ω) {=0.5 Ω nominal}.

V_D is the diode forward voltage at the required load current (V).

Diode Selection

For maximum efficiency and performance, the rectifier (D1) should be a fast low capacitance Schottky diode with low reverse leakage at the maximum operating voltage and temperature.

They also provide better efficiency than silicon diodes, due to a combination of lower forward voltage and reduced recovery time.

It is important to select parts with a peak current rating above the peak coil current and a continuous current rating higher than the maximum output load current. It is very important to consider the reverse leakage of the diode when operating above 85°C. Excess leakage will increase the power dissipation in the device and if close to the load may create a thermal runaway condition.

The higher forward voltage and overshoot due to reverse recovery time in silicon diodes will increase the peak voltage on the LX output. If a silicon diode is used, care should be taken to ensure that the total voltage appearing on the LX pin including supply ripple, does not exceed the specified maximum value.

PCB Layout Guidelines

Careful PCB layout is critical to achieve low switching losses and stable operation. Minimize ground noise by connecting high current ground returns, the input bypass capacitor ground lead, and the output filter ground lead to a single point. Place R_s as close as possible to the ISENSE and VIN. For better noise immunity, a Kelvin connection is strongly recommended between ISENSE and R_s.

Package Information

UM1360Y SOT89-5

Outline Drawing

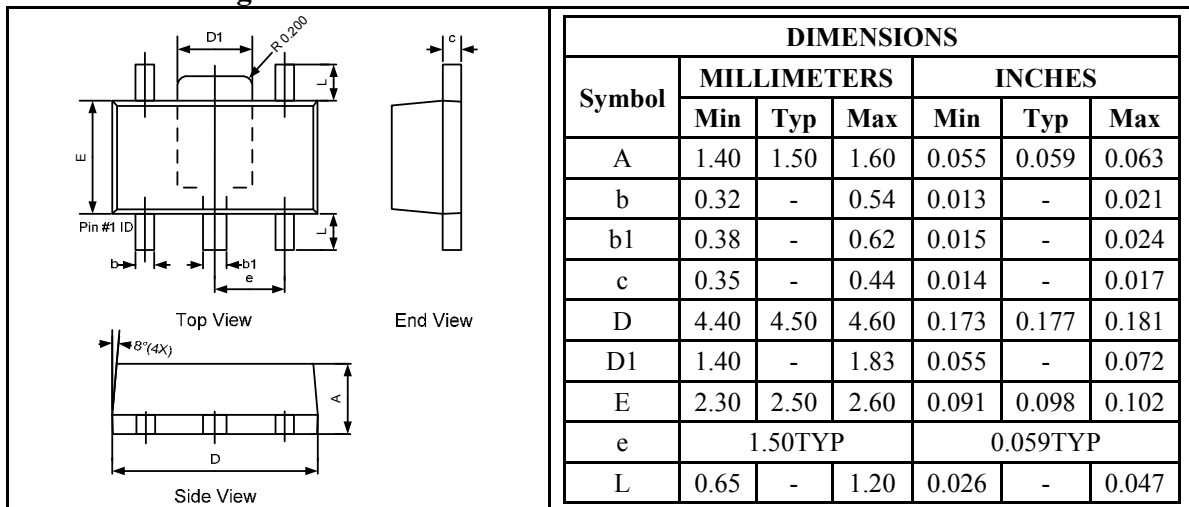

Land Pattern

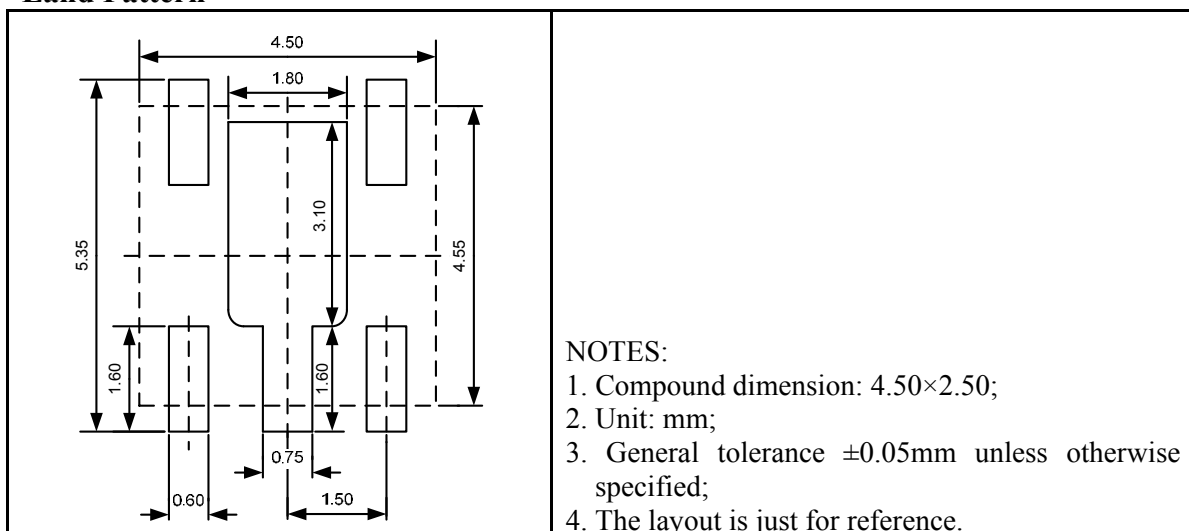

Tape and Reel Orientation

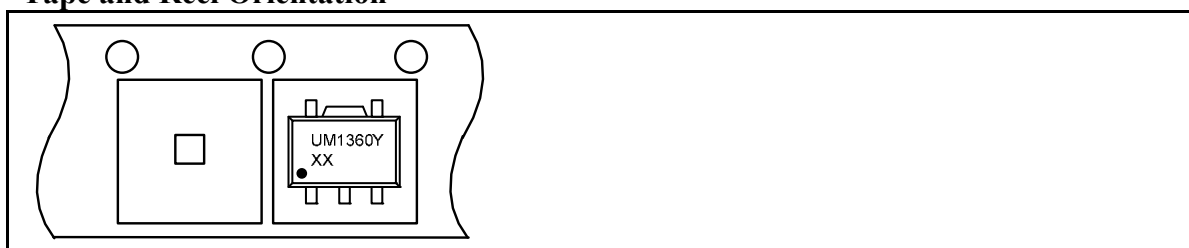

GREEN COMPLIANCE

Union Semiconductor is committed to environmental excellence in all aspects of its operations including meeting or exceeding regulatory requirements with respect to the use of hazardous substances. Numerous successful programs have been implemented to reduce the use of hazardous substances and/or emissions.

All Union components are compliant with the RoHS directive, which helps to support customers in their compliance with environmental directives. For more green compliance information, please visit:

http://www.union-ic.com/index.aspx?cat_code=RoHSDeclaration

IMPORTANT NOTICE

The information in this document has been carefully reviewed and is believed to be accurate. Nonetheless, this document is subject to change without notice. Union assumes no responsibility for any inaccuracies that may be contained in this document, and makes no commitment to update or to keep current the contained information, or to notify a person or organization of any update. Union reserves the right to make changes, at any time, in order to improve reliability, function or design and to attempt to supply the best product possible.



Union Semiconductor, Inc

Add: Unit 606, No.570 Shengxia Road, Shanghai 201210

Tel: 021-51093966

Fax: 021-51026018

Website: www.union-ic.com