

## SNx4HC164 8-Bit Parallel-Out Serial Shift Registers

### 1 Features

- Wide Operating Voltage Range of 2 V to 6 V
- Outputs Can Drive Up to 10 LSTTL Loads
- Low Power Consumption, 80- $\mu$ A Maximum  $I_{CC}$
- Typical  $t_{pd} = 20$  ns
- $\pm 4$ -mA Output Drive at 5 V
- Low Input Current of 1- $\mu$ A Maximum
- AND-Gated (Enable/Disable) Serial Inputs
- Fully Buffered Clock and Serial Inputs
- Direct Clear
- On Products Compliant to MIL-PRF-38535, All Parameters Are Tested Unless Otherwise Noted. On All Other Products, Production Processing Does Not Necessarily Include Testing of All Parameters.

### 2 Applications

- Programmable Logic Controllers
- Appliances
- Video Display Systems
- Output Expander

### 3 Description

These 8-bit shift registers feature AND-gated serial inputs and an asynchronous clear (CLR) input. The gated serial (A and B) inputs permit complete control over incoming data; a low at either input inhibits entry of the new data and resets the first flip-flop to the low level at the next clock (CLK) pulse. A high-level input enables the other input, which then determines the state of the first flip-flop. Data at the serial inputs can be changed while CLK is high or low, provided the minimum set-up time requirements are met. Clocking occurs on the low-to-high-level transition of CLK.

#### Device Information<sup>(1)</sup>

PART NUMBER	PACKAGE	BODY SIZE (NOM)
SN74HC164	SOIC (14)	8.65 mm $\times$ 3.91 mm
	PDIP (14)	19.30 mm $\times$ 6.35 mm
	SO (14)	10.30 mm $\times$ 5.30 mm
	TSSOP (14)	5.00 mm $\times$ 4.40 mm
SN54HC164	CDIP (14)	19.94 mm $\times$ 6.92 mm
	CFP (14)	9.21 mm $\times$ 6.29 mm
	LCCC (14)	9.39 mm $\times$ 9.39 mm

(1) For all available packages, see the orderable addendum at the end of the data sheet.

#### Logic Diagram (Positive Logic)

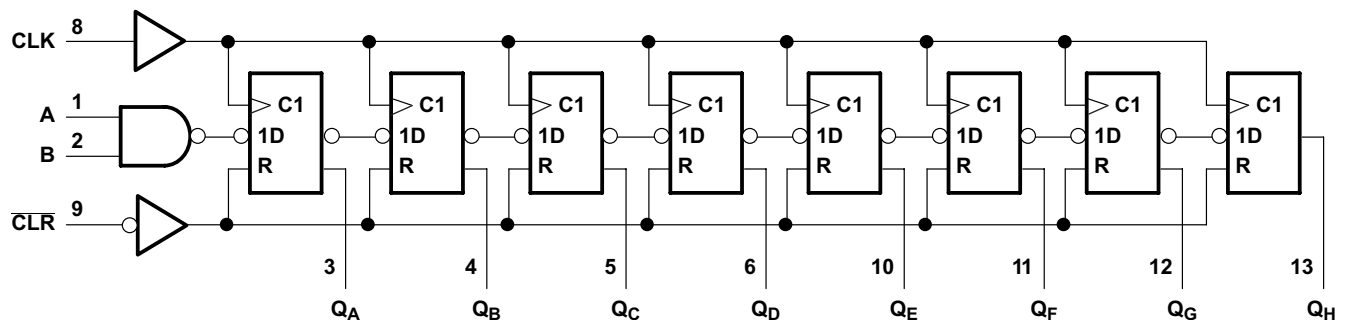

Pin numbers shown are for the D, J, N, NS, PW, and W packages.



## Table of Contents

<b>1</b>	<b>Features</b> .....	<b>1</b>	<b>8</b>	<b>Parameter Measurement Information</b> .....	<b>13</b>
<b>2</b>	<b>Applications</b> .....	<b>1</b>	<b>9</b>	<b>Detailed Description</b> .....	<b>14</b>
<b>3</b>	<b>Description</b> .....	<b>1</b>	9.1	Overview .....	14
<b>4</b>	<b>Revision History</b> .....	<b>2</b>	9.2	Functional Block Diagram .....	14
<b>5</b>	<b>Device Comparison Table</b> .....	<b>3</b>	9.3	Feature Description.....	14
<b>6</b>	<b>Pin Configuration and Functions</b> .....	<b>4</b>	9.4	Device Functional Modes.....	14
<b>7</b>	<b>Specifications</b> .....	<b>6</b>	<b>10</b>	<b>Application and Implementation</b> .....	<b>15</b>
7.1	Absolute Maximum Ratings .....	6	10.1	Application Information.....	15
7.2	ESD Ratings .....	6	10.2	Typical Application .....	15
7.3	Recommended Operating Conditions.....	6	<b>11</b>	<b>Power Supply Recommendations</b> .....	<b>17</b>
7.4	Thermal Information .....	7	<b>12</b>	<b>Layout</b> .....	<b>17</b>
7.5	Electrical Characteristics, $T_A = 25^\circ\text{C}$ .....	7	12.1	Layout Guidelines .....	17
7.6	Electrical Characteristics, $T_A = -55^\circ\text{C}$ to $125^\circ\text{C}$ .....	7	12.2	Layout Example .....	17
7.7	Electrical Characteristics, $T_A = -55^\circ\text{C}$ to $85^\circ\text{C}$ .....	8	<b>13</b>	<b>Device and Documentation Support</b> .....	<b>18</b>
7.8	Timing Requirements, $T_A = 25^\circ\text{C}$ .....	8	13.1	Documentation Support .....	18
7.9	Timing Requirements, $T_A = -55^\circ\text{C}$ to $125^\circ\text{C}$ .....	9	13.2	Related Links .....	18
7.10	Timing Requirements, $T_A = -55^\circ\text{C}$ to $85^\circ\text{C}$ .....	9	13.3	Community Resources.....	18
7.11	Switching Characteristics, $T_A = 25^\circ\text{C}$ .....	10	13.4	Trademarks .....	18
7.12	Switching Characteristics, $T_A = -55^\circ\text{C}$ to $125^\circ\text{C}$ ..	10	13.5	Electrostatic Discharge Caution.....	18
7.13	Switching Characteristics, $T_A = -55^\circ\text{C}$ to $85^\circ\text{C}$ ....	11	13.6	Glossary .....	18
7.14	Typical Characteristics .....	12	<b>14</b>	<b>Mechanical, Packaging, and Orderable Information</b> .....	<b>18</b>

## 4 Revision History

NOTE: Page numbers for previous revisions may differ from page numbers in the current version.

### Changes from Revision F (October 2013) to Revision G

Page

• Added <i>Applications</i> section, <i>Device Information</i> table, <i>Pin Configuration and Functions</i> section, <i>ESD Ratings</i> table, <i>Thermal Information</i> table, <i>Typical Characteristics</i> section, <i>Feature Description</i> section, <i>Device Functional Modes</i> , <i>Application and Implementation</i> section, <i>Power Supply Recommendations</i> section, <i>Layout</i> section, <i>Device and Documentation Support</i> section, and <i>Mechanical, Packaging, and Orderable Information</i> section.....	1
• Added Military Disclaimer to <i>Features</i> list .....	1
• Added Handling Ratings table.....	6

### Changes from Revision E (November 2010) to Revision F

Page

• Updated document to new TI data sheet format .....	1
• Removed Ordering Information table .....	1
• Updated operating temperature range .....	6

## 5 Device Comparison Table

PART NUMBER	PACKAGE	BODY SIZE (NOM)
SN74HC164D	SOIC (14)	8.65 mm × 3.91 mm
SN74HC164N	PDIP (14)	19.30 mm × 6.35 mm
SN74HC164NS	SO (14)	10.30 mm × 5.30 mm
SN74HC164PW	TSSOP (14)	5.00 mm × 4.40 mm
SN54HC164J	CDIP (14)	19.94 mm × 6.92 mm
SN54HC164W	CFP (14)	9.21 mm × 6.29 mm
SN54HC164FK	LCCC (14)	9.39 mm × 9.39 mm

## 6 Pin Configuration and Functions

D, N, NS, J, W, or PW Package  
 14-Pin SOIC, PDIP, SO, CDIP, CFP, or TSSOP  
 Top View

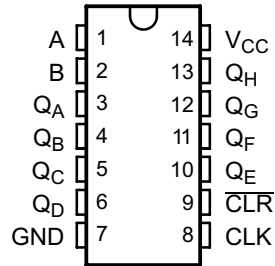

### Pin Functions

PIN		I/O	DESCRIPTION
SOIC, PDIP, SO, CDIP, CFP, or TSSOP NO.	NAME		
1	A	I	Gated Serial Input 1
2	B	I	Gated Serial Input 2
3	Q <sub>A</sub>	O	Parallel Output
4	Q <sub>B</sub>	O	Parallel Output
5	Q <sub>C</sub>	O	Parallel Output
6	Q <sub>D</sub>	O	Parallel Output
7	GND	-	Ground
8	CLK	I	Clock
9	$\overline{\text{CLR}}$	I	Clear 1 Active-Low
10	Q <sub>E</sub>	O	Parallel Output
11	Q <sub>F</sub>	O	Parallel Output
12	Q <sub>G</sub>	O	Parallel Output
13	Q <sub>H</sub>	O	Parallel Output
14	V <sub>CC</sub>	—	Power

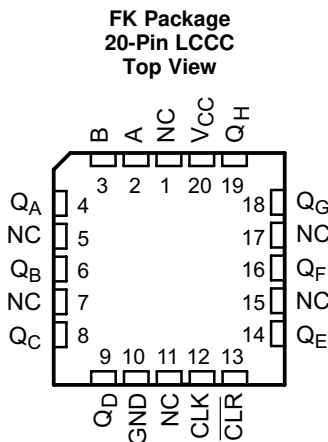

NC – No internal connection

**Pin Functions**

PIN		I/O	DESCRIPTION
LCCC NO.	NAME		
1	NC	—	No Connect
2	A	I	Gated Serial Input 1
3	B	I	Gated Serial Input 2
4	Q <sub>A</sub>	O	Parallel Output
5	NC	—	No Connect
6	Q <sub>B</sub>	O	Parallel Output
7	NC	—	No Connect
8	Q <sub>C</sub>	O	Parallel Output
9	Q <sub>D</sub>	O	Parallel Output
10	GND	—	Ground
11	NC	—	No Connect
12	CLK	I	Clock
13	$\overline{\text{CLR}}$	I	Clear 1 Active-Low
14	Q <sub>E</sub>	O	Parallel Output
15	NC	—	No Connect
16	Q <sub>F</sub>	O	Parallel Output
17	NC	—	No Connect
18	Q <sub>G</sub>	O	Parallel Output
19	Q <sub>H</sub>	O	Parallel Output
20	VCC	—	Power

## 7 Specifications

### 7.1 Absolute Maximum Ratings

 over operating free-air temperature range (unless otherwise noted)<sup>(1)</sup>

		MIN	MAX	UNITS
V <sub>CC</sub>	Supply voltage	-0.5	7	V
I <sub>IK</sub>	Input clamp current <sup>(2)</sup>	V <sub>I</sub> < 0 or V <sub>I</sub> > V <sub>CC</sub>		±20 mA
I <sub>OK</sub>	Output clamp current <sup>(2)</sup>	V <sub>O</sub> < 0 or V <sub>O</sub> > V <sub>CC</sub>		±20 mA
I <sub>O</sub>	Continuous output current	V <sub>O</sub> = 0 to V <sub>CC</sub>		±25 mA
	Continuous current through V <sub>CC</sub> or GND			±50 mA
T <sub>stg</sub>	Storage temperature	-65	150	°C

- (1) Stresses beyond those listed under *Absolute Maximum Ratings* may cause permanent damage to the device. These are stress ratings only, and functional operation of the device at these or any other conditions beyond those indicated under *Recommended Operating Conditions* is not implied. Exposure to absolute-maximum-rated conditions for extended periods may affect device reliability.
- (2) The input and output voltage ratings may be exceeded if the input and output current ratings are observed.

### 7.2 ESD Ratings

		VALUE	UNIT
V <sub>(ESD)</sub>	Electrostatic discharge	Human body model (HBM), per ANSI/ESDA/JEDEC JS-001 <sup>(1)</sup>	±2000
		Charged-device model (CDM), per JEDEC specification JESD22-C101 <sup>(2)</sup>	±1000

- (1) JEDEC document JEP155 states that 500-V HBM allows safe manufacturing with a standard ESD control process.
- (2) JEDEC document JEP157 states that 250-V CDM allows safe manufacturing with a standard ESD control process.

### 7.3 Recommended Operating Conditions

 over operating free-air temperature range (unless otherwise noted)<sup>(1)</sup>

		SN54HC164			SN74HC164			UNIT
		MIN	NOM	MAX	MIN	NOM	MAX	
V <sub>CC</sub>	Supply voltage	2	5	6	2	5	6	V
V <sub>IH</sub>	High-level input voltage	V <sub>CC</sub> = 2 V		1.5	1.5			V
		V <sub>CC</sub> = 4.5 V		3.15	3.15			
		V <sub>CC</sub> = 6 V		4.2	4.2			
V <sub>IL</sub>	Low-level input voltage	V <sub>CC</sub> = 2 V			0.5		0.5	V
		V <sub>CC</sub> = 4.5 V			1.35		1.35	
		V <sub>CC</sub> = 6 V			1.8		1.8	
V <sub>I</sub>	Input voltage	0		V <sub>CC</sub>	0		V <sub>CC</sub>	V
V <sub>O</sub>	Output voltage	0		V <sub>CC</sub>	0		V <sub>CC</sub>	V
Δt/ΔV <sup>(2)</sup>	Input transition rise and fall time	V <sub>CC</sub> = 2 V			1000		1000	ns
		V <sub>CC</sub> = 4.5 V			500		500	
		V <sub>CC</sub> = 6 V			400		400	
T <sub>A</sub>	Operating free-air temperature	-55		125	-40		125	°C

- (1) All unused inputs of the device must be held at V<sub>CC</sub> or GND to ensure proper device operation. Refer to the TI application report, *Implications of Slow or Floating CMOS Inputs*, [SCBA004](#).
- (2) If this device is used in the threshold region (from V<sub>IL</sub> max = 0.5 V to V<sub>IH</sub> min = 1.5 V), there is a potential to go into the wrong state from induced grounding, causing double clocking. Operating with the inputs at t<sub>I</sub> = 1000 ns and V<sub>CC</sub> = 2 V does not damage the device; however, functionally, the CLK inputs are not ensured while in the shift, count, or toggle operating modes.

## 7.4 Thermal Information

THERMAL METRIC <sup>(1)</sup>	SN54HC164			SN74HC164				UNIT
	J (CDIP)	W (CFP)	FK (LCCC)	D (SOIC)	N (PDIP)	NS (SO)	PW (TSSOP)	
	14 PINS	14 PINS	20 PINS	14 PINS	14 PINS	14 PINS	14 PINS	
R <sub>θJA</sub> Junction-to-ambient thermal resistance	—	—	—	86	80	76	113	°C/W

(1) For more information about traditional and new thermal metrics, see the *Semiconductor and IC Package Thermal Metrics* application report, [SPRA953](#).

## 7.5 Electrical Characteristics, T<sub>A</sub> = 25°C

over recommended operating free-air temperature range (unless otherwise noted)

PARAMETER	TEST CONDITIONS		V <sub>CC</sub>	MIN	TYP	MAX	UNIT
V <sub>OH</sub>	V <sub>I</sub> = V <sub>IH</sub> or V <sub>IL</sub>	I <sub>OH</sub> = -20 μA	2 V	1.9	1.998		V
			4.5 V	4.4	4.499		
			6 V	5.9	5.999		
		I <sub>OH</sub> = -4 mA	4.5 V	3.98	4.3		
		I <sub>OH</sub> = -5.2 mA	6 V	5.48	5.8		
V <sub>OL</sub>	V <sub>I</sub> = V <sub>IH</sub> or V <sub>IL</sub>	I <sub>OL</sub> = 20 μA	2 V		0.002	0.1	V
			4.5 V		0.001	0.1	
			6 V		0.001	0.1	
		I <sub>OL</sub> = 4 mA	4.5 V		0.17	0.26	
		I <sub>OL</sub> = 5.2 mA	6 V		0.15	0.26	
I <sub>I</sub>	V <sub>I</sub> = V <sub>CC</sub> or 0		6 V		±0.1	±100	nA
I <sub>CC</sub>	V <sub>I</sub> = V <sub>CC</sub> or 0	I <sub>O</sub> = 0	6 V			8	μA
C <sub>i</sub>			2 V to 6 V		3	10	pF

## 7.6 Electrical Characteristics, T<sub>A</sub> = -55°C to 125°C

over recommended operating free-air temperature range (unless otherwise noted)

PARAMETER	TEST CONDITIONS		V <sub>CC</sub>	SN54HC164			Recommended SN74HC164			UNIT
				MIN	TYP	MAX	MIN	TYP	MAX	
V <sub>OH</sub>	V <sub>I</sub> = V <sub>IH</sub> or V <sub>IL</sub>	I <sub>OH</sub> = -20 μA	2 V	1.9			1.9			V
			4.5 V	4.4			4.4			
			6 V	5.9			5.9			
		I <sub>OH</sub> = -4 mA	4.5 V	3.7			3.7			
		I <sub>OH</sub> = -5.2 mA	6 V	5.2			5.2			
V <sub>OL</sub>	V <sub>I</sub> = V <sub>IH</sub> or V <sub>IL</sub>	I <sub>OL</sub> = 20 μA	2 V						0.1	V
			4.5 V						0.1	
			6 V						0.1	
		I <sub>OL</sub> = 4 mA	4.5 V					0.4		
		I <sub>OL</sub> = 5.2 mA	6 V					0.4		
I <sub>I</sub>	V <sub>I</sub> = V <sub>CC</sub> or 0		6 V					±1000	±1000	nA
I <sub>CC</sub>	V <sub>I</sub> = V <sub>CC</sub> or 0	I <sub>O</sub> = 0	6 V					160	160	μA
C <sub>i</sub>			2 V to 6 V						10	pF

## 7.7 Electrical Characteristics, $T_A = -55^\circ\text{C}$ to $85^\circ\text{C}$

over recommended operating free-air temperature range (unless otherwise noted)

PARAMETER	TEST CONDITIONS		$V_{CC}$	SN74HC164			UNIT
				MIN	TYP	MAX	
$V_{OH}$	$V_I = V_{IH}$ or $V_{IL}$	$I_{OH} = -20\ \mu\text{A}$	2 V	1.9		V	
			4.5 V	4.4			
			6 V	5.9			
		$I_{OH} = -4\ \text{mA}$	4.5 V	3.84			
			6 V	5.34			
$V_{OL}$	$V_I = V_{IH}$ or $V_{IL}$	$I_{OL} = 20\ \mu\text{A}$	2 V		0.1	V	
			4.5 V		0.1		
			6 V		0.1		
		$I_{OL} = 4\ \text{mA}$	4.5 V		0.33		
			6 V		0.33		
$I_I$	$V_I = V_{CC}$ or 0		6 V		$\pm 1000$	nA	
$I_{CC}$	$V_I = V_{CC}$ or 0	$I_O = 0$	6 V		80	$\mu\text{A}$	
$C_i$			2 V to 6 V		10	pF	

## 7.8 Timing Requirements, $T_A = 25^\circ\text{C}$

over recommended operating free-air temperature range (unless otherwise noted)

PARAMETER		$V_{CC}$	MIN	NOM	MAX	UNIT
$f_{\text{clock}}$	Clock frequency	2 V			6	MHz
		4.5 V			31	
		6 V			36	
$t_w$	Pulse duration	$\overline{\text{CLR}}$ low	2 V	100		ns
			4.5 V	20		
			6 V	17		
	CLK high or low	2 V	80			
		4.5 V	16			
		6 V	14			
$t_{su}$	Setup time before CLK $\uparrow$	Data	2 V	100		ns
			4.5 V	20		
			6 V	17		
	$\overline{\text{CLR}}$ inactive	2 V	100			
		4.5 V	20			
		6 V	17			
$t_h$	Hold time, data after CLK $\uparrow$	2 V	5		ns	
		4.5 V	5			
		6 V	5			



## 7.9 Timing Requirements, $T_A = -55^\circ\text{C}$ to $125^\circ\text{C}$

over recommended operating free-air temperature range (unless otherwise noted)

PARAMETER		$V_{CC}$	SN54HC164			RECOMMENDED SN74HC164			UNIT
			MIN	NOM	MAX	MIN	NOM	MAX	
$f_{\text{clock}}$	Clock frequency	2 V			4.2			4.2	MHz
		4.5 V			21			21	
		6 V			25			25	
$t_w$	$\overline{\text{CLR}}$ low	2 V	150			125			ns
		4.5 V	30			25			
		6 V	25			21			
	CLK high or low	2 V		120			120		
		4.5 V		24			24		
		6 V		20			20		
$t_{\text{su}}$	Data	2 V	150			125			ns
		4.5 V	30			25			
		6 V	25			25			
	$\overline{\text{CLR}}$ inactive	2 V	150			125			
		4.5 V	30			25			
		6 V	25			25			
$t_h$	Hold time, data after CLK $\uparrow$	2 V		5			5	ns	
		4.5 V		5			5		
		6 V		5			5		

## 7.10 Timing Requirements, $T_A = -55^\circ\text{C}$ to $85^\circ\text{C}$

over recommended operating free-air temperature range (unless otherwise noted)

PARAMETER		$V_{CC}$	SN74HC164			UNIT
			MIN	NOM	MAX	
$f_{\text{clock}}$	Clock frequency	2 V			5	MHz
		4.5 V			25	
		6 V			28	
$t_w$	$\overline{\text{CLR}}$ low	2 V	125			ns
		4.5 V	25			
		6 V	21			
	CLK high or low	2 V		100		
		4.5 V		20		
		6 V		18		
$t_{\text{su}}$	Data	2 V	125			ns
		4.5 V	25			
		6 V	21			
	$\overline{\text{CLR}}$ inactive	2 V	125			
		4.5 V	25			
		6 V	21			
$t_h$	Hold time, data after CLK $\uparrow$	2 V		5		ns
		4.5 V		5		
		6 V		5		

**SN54HC164, SN74HC164**

SCLS115G – DECEMBER 1982 – REVISED SEPTEMBER 2015

[www.ti.com](http://www.ti.com)
**7.11 Switching Characteristics,  $T_A = 25^\circ\text{C}$** 

 over recommended operating free-air temperature range,  $C_L = 50\text{ pF}$  (unless otherwise noted) (see [Figure 3](#))

PARAMETER	FROM (INPUT)	TO (OUTPUT)	$V_{CC}$	MIN	TYP	MAX	UNIT
$f_{max}$			2 V	6	10		MHz
			4.5 V	31	54		
			6 V	36	62		
$t_{PHL}$	$\overline{CLR}$	Any Q	2 V		140	205	ns
			4.5 V		28	41	
			6 V		24	35	
$t_{pd}$	CLK	Any Q	2 V		115	175	
			4.5 V		23	35	
			6 V		20	30	
$t_t$			2 V		38	75	ns
			4.5 V		8	15	
			6 V		6	13	

**7.12 Switching Characteristics,  $T_A = -55^\circ\text{C}$  to  $125^\circ\text{C}$** 

 over recommended operating free-air temperature range,  $C_L = 50\text{ pF}$  (unless otherwise noted) (see [Figure 3](#))

PARAMETER	FROM (INPUT)	TO (OUTPUT)	$V_{CC}$	SN54HC164			RECOMMENDED SN74HC164			UNIT
				MIN	TYP	MAX	MIN	TYP	MAX	
$f_{max}$			2 V	4.2			4.2			MHz
			4.5 V	21			21			
			6 V	25			25			
$t_{PHL}$	$\overline{CLR}$	Any Q	2 V			295			255	ns
			4.5 V			59			51	
			6 V			51			46	
$t_{pd}$	CLK	Any Q	2 V			265			220	
			4.5 V			53			44	
			6 V			45			38	
$t_t$			2 V			110			110	ns
			4.5 V			22			22	
			6 V			19			19	

**7.13 Switching Characteristics, T<sub>A</sub> = –55°C to 85°C**

over recommended operating free-air temperature range, C<sub>L</sub> = 50 pF (unless otherwise noted) (see Figure 3)

PARAMETER	FROM (INPUT)	TO (OUTPUT)	V <sub>CC</sub>	SN74HC164			UNIT
				MIN	TYP	MAX	
f <sub>max</sub>			2 V	5			MHz
			4.5 V	25			
			6 V	28			
t <sub>PHL</sub>	CLR	Any Q	2 V	255			ns
			4.5 V	51			
			6 V	46			
t <sub>pd</sub>	CLK	Any Q	2 V	220			
			4.5 V	44			
			6 V	38			
t <sub>t</sub>			2 V	95			ns
			4.5 V	19			
			6 V	16			

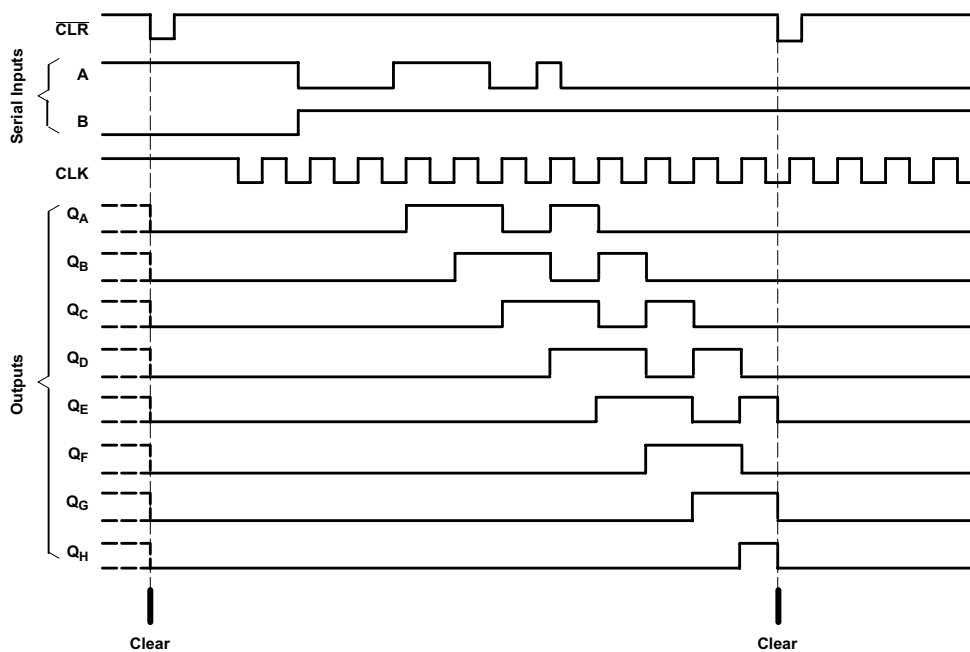

**Figure 1. SN74HC164 Example Timing Diagram**

**SN54HC164, SN74HC164**

SCLS115G – DECEMBER 1982 – REVISED SEPTEMBER 2015

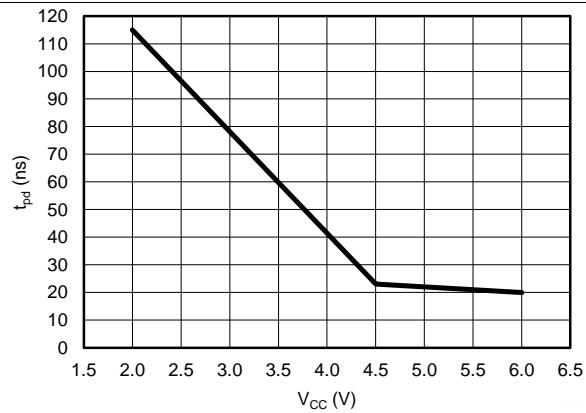
[www.ti.com](http://www.ti.com)
**7.14 Typical Characteristics**
 $T_A = 25^\circ\text{C}$ 

**Figure 2. Propagation Delay vs Supply Voltage at  $T_A = 25^\circ\text{C}$**

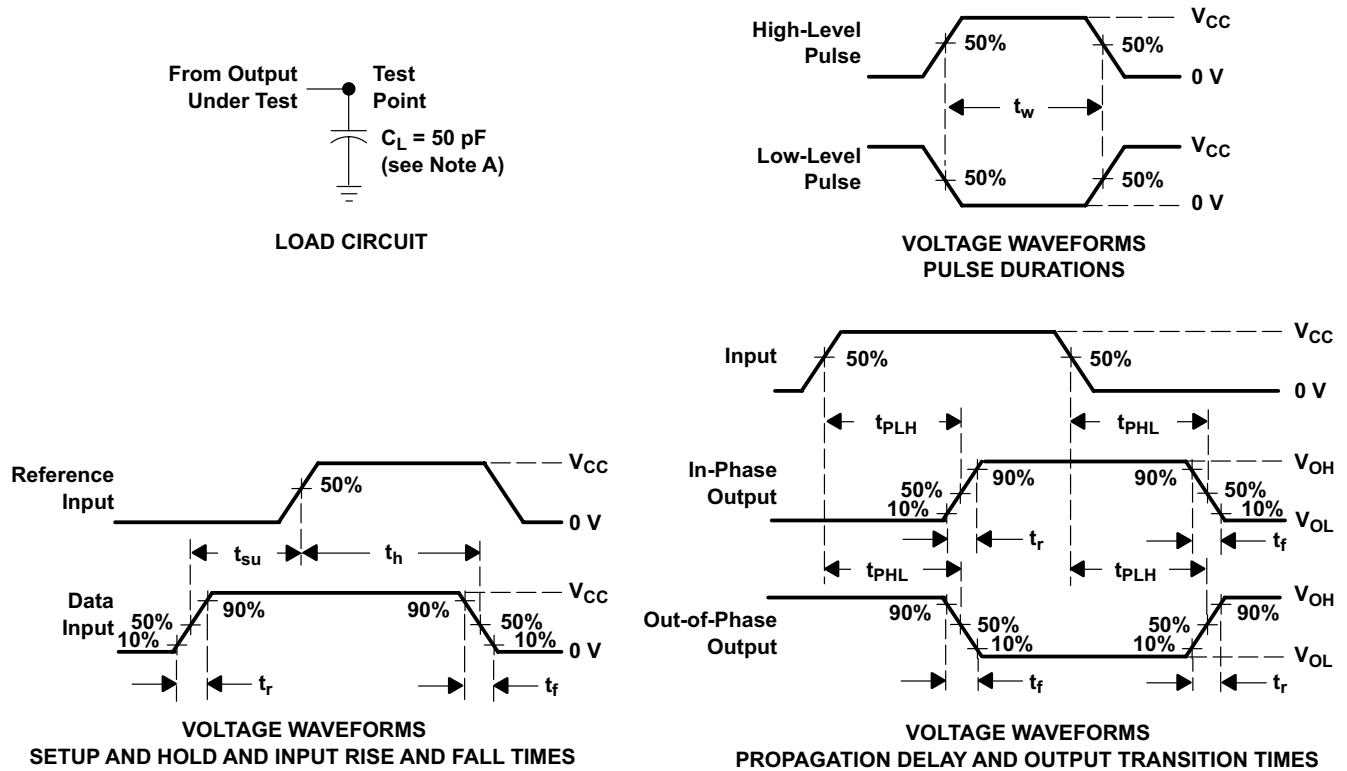
## 8 Parameter Measurement Information



- NOTES:
- A.  $C_L$  includes probe and test-fixtue capacitance.
  - B. Phase relationships between waveforms were chosen arbitrarily. All input pulses are supplied by generators having the following characteristics:  $PRR \leq 1 \text{ MHz}$ ,  $Z_O = 50 \Omega$ ,  $t_r = 6 \text{ ns}$ ,  $t_f = 6 \text{ ns}$ .
  - C. For clock inputs,  $f_{max}$  is measured when the input duty cycle is 50%.
  - D. The outputs are measured one at a time with one input transition per measurement.
  - E.  $t_{PLH}$  and  $t_{PHL}$  are the same as  $t_{pd}$ .

**Figure 3. Load Circuit and Voltage Waveforms**

## 9 Detailed Description

### 9.1 Overview

The SN74HC164 is an 8-bit shift register with 2 serial inputs (A and B) connected through an AND gate, as well as an asynchronous clear (CLR). The device requires a high signal on both A and B in order to set the input data line high; a low signal on either input will set the input data line low. Data at A and B can be changed while CLK is high or low, provided that the minimum set-up time requirements are met.

The CLK pin of the SN74HC164 is triggered on a positive or rising-edge signal, from LOW to HIGH. Upon a positive-edge trigger, the device will store the result of the (A • B) input data line in the first register and propagate each register's data to the next register. The data of the last register, Q<sub>H</sub>, will be discarded at each clock trigger. If a low signal is applied to the CLR pin of the SN74HC164, the device will set all registers to a value of 0 immediately.

### 9.2 Functional Block Diagram

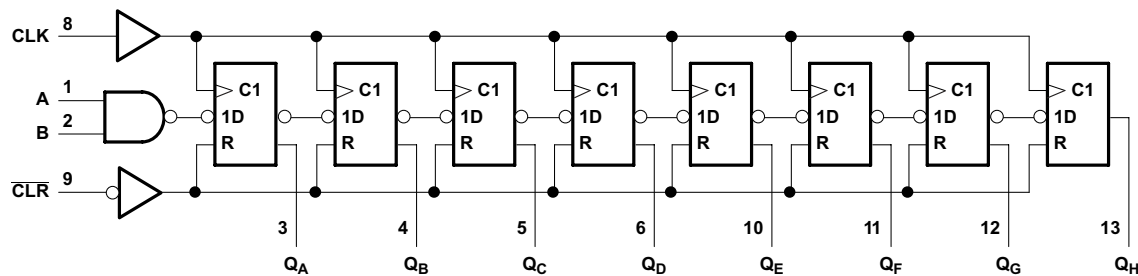

Pin numbers shown are for the D, J, N, NS, PW, and W packages.

### 9.3 Feature Description

The HC164 has a wide operating voltage range of 2 V to 6 V, outputs that can drive up to 10 LSTTL loads and Low Power Consumption, 80- $\mu$ A maximum I. It is typically  $t_{pd} = 20$  ns and has  $\pm 4$ -mA output drive at 5 V with low input current of 1- $\mu$ A maximum. It also has AND-gated (enable/disable) serial inputs a fully buffered clock and serial inputs as well as a direct clear.

### 9.4 Device Functional Modes

Table 1 lists the functional modes of the SNx4HC164.

**Table 1. Function Table**<sup>(1)(2)</sup>

INPUTS				OUTPUTS			
$\overline{\text{CLR}}$	CLK	A	B	Q <sub>A</sub>	Q <sub>B</sub>	...	Q <sub>H</sub>
L	X	X	X	L	L		L
H	L	X	X	Q <sub>A0</sub>	Q <sub>B0</sub>		Q <sub>H0</sub>
H	$\uparrow$	H	H	H	Q <sub>An</sub>		Q <sub>Gn</sub>
H	$\uparrow$	L	X	L	Q <sub>An</sub>		Q <sub>Gn</sub>
H	$\uparrow$	X	L	L	Q <sub>An</sub>		Q <sub>Gn</sub>

- (1) Q<sub>A0</sub>, Q<sub>B0</sub>, Q<sub>H0</sub> = the level of Q<sub>A</sub>, Q<sub>B</sub>, or Q<sub>H</sub>, respectively, before the indicated steady-state input conditions were established.
- (2) Q<sub>An</sub>, Q<sub>Gn</sub> = the level of Q<sub>A</sub> or Q<sub>G</sub> before the most recent  $\uparrow$  transition of CLK: indicates a 1-bit shift.

## 10 Application and Implementation

### 10.1 Application Information

The SNx4HC164 is an 8-bit shift register that can be used as a deserializer in order to reduce the number of GPIO's needed when driving multiple LED's. In order to correctly display the proper output in the LED's a sink MOSFET was added to prevent the LED's from lighting up until the correct data or the proper clock signal has been achieved.

### 10.2 Typical Application

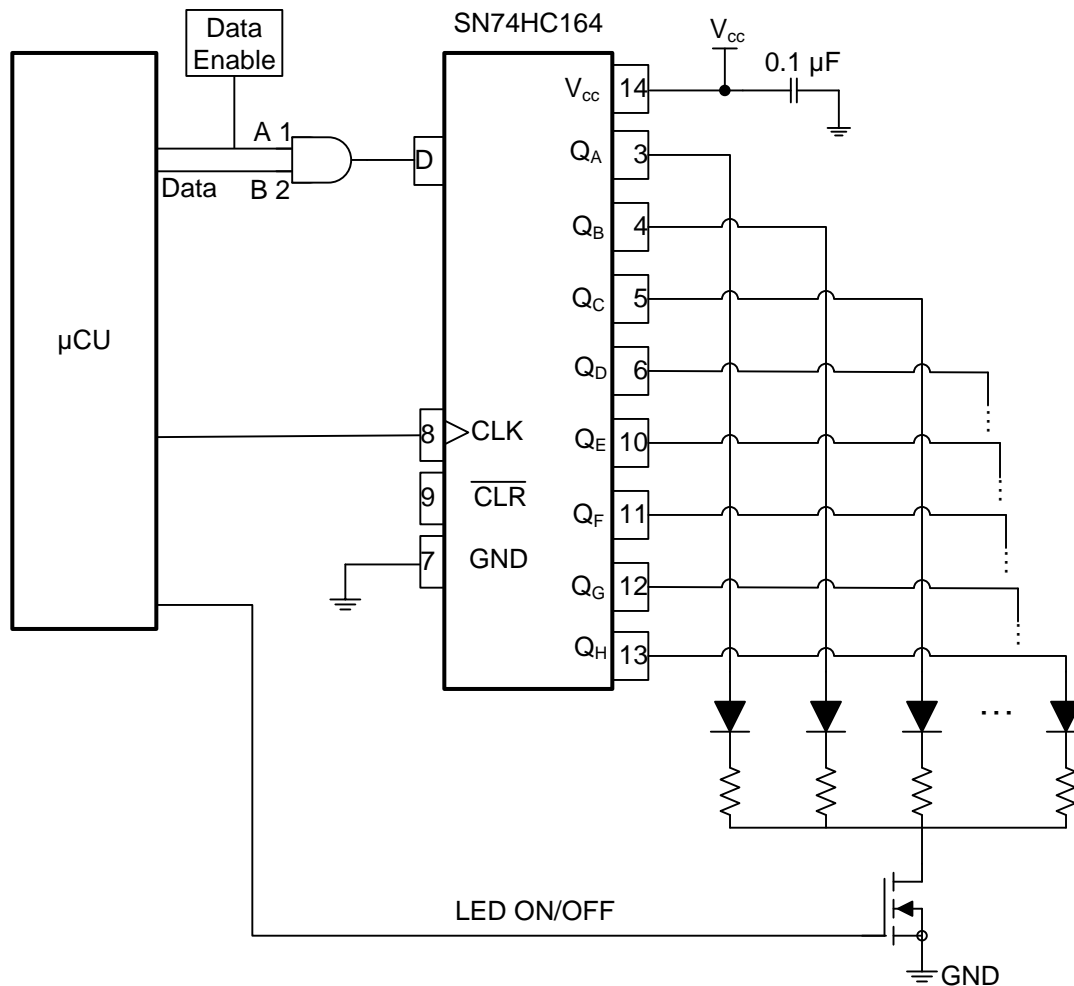

Figure 4. Typical Application Diagram

#### 10.2.1 Design Requirements

Ensure that the incoming clock rising edge meets the criteria in [Recommended Operating Conditions](#).

#### 10.2.2 Detailed Design Procedure

Ensure that input and output voltages do not exceed ratings in [Absolute Maximum Ratings](#).

Input voltage threshold information can be found in [Recommended Operating Conditions](#).

Detailed timing requirements can be found in [Timing Requirements](#),  $T_A = 25^\circ\text{C}$ .

**Typical Application (continued)**

**10.2.3 Application Curve**

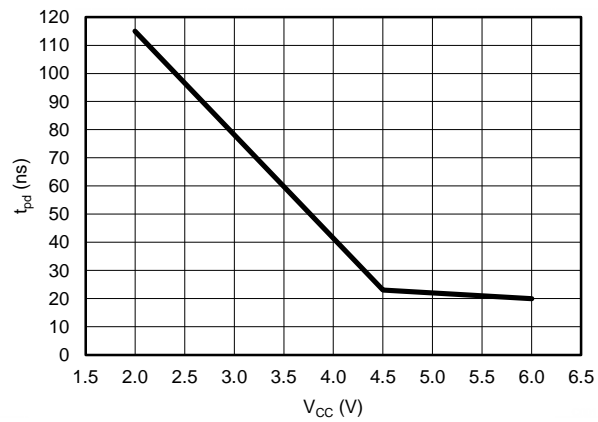

**Figure 5. Propagation Delay vs Supply Voltage at  $T_A = 25^\circ\text{C}$**



## 11 Power Supply Recommendations

The power supply can be any voltage between the minimum and maximum supply voltage rating located in the [Recommended Operating Conditions](#) table.

Each  $V_{CC}$  pin must have a good bypass capacitor in order to prevent power disturbance. For devices with a single supply, a 0.1- $\mu\text{F}$  capacitor is recommended and if there are multiple  $V_{CC}$  pins then a 0.01- $\mu\text{F}$  or 0.022- $\mu\text{F}$  capacitor is recommended for each power pin. It is ok to parallel multiple bypass caps to reject different frequencies of noise. 0.1- $\mu\text{F}$  and 1- $\mu\text{F}$  capacitors are commonly used in parallel. The bypass capacitor should be installed as close to the power pin as possible for best results.

## 12 Layout

### 12.1 Layout Guidelines

Reflections and matching are closely related to loop antenna theory, but different enough to warrant their own discussion. When a PCB trace turns a corner at a 90° angle, a reflection can occur. This is primarily due to the change of width of the trace. At the apex of the turn, the trace width is increased to 1.414 times its width. This upsets the transmission line characteristics, especially the distributed capacitance and self-inductance of the trace — resulting in the reflection. It is a given that not all PCB traces can be straight, and so they will have to turn corners. [Figure 6](#) shows progressively better techniques of rounding corners. Only the last example maintains constant trace width and minimizes reflections.

### 12.2 Layout Example

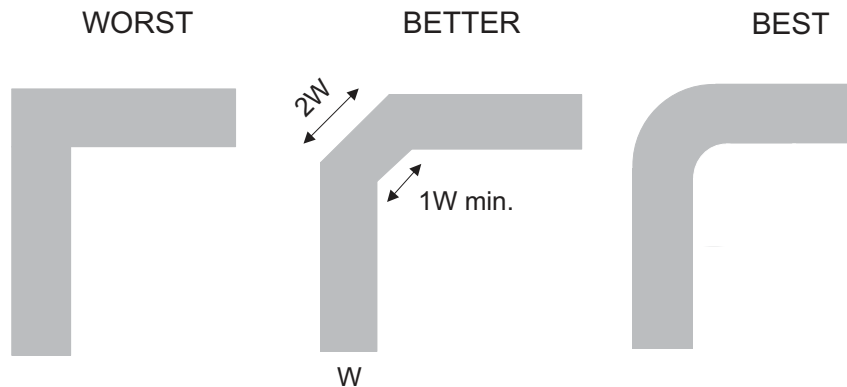

**Figure 6. Trace Example**

## 13 Device and Documentation Support

### 13.1 Documentation Support

#### 13.1.1 Related Documentation

For related documentation, see the following:

*Implications of Slow or Floating CMOS Inputs*, [SCBA004](#)

### 13.2 Related Links

The table below lists quick access links. Categories include technical documents, support and community resources, tools and software, and quick access to sample or buy.

**Table 2. Related Links**

PARTS	PRODUCT FOLDER	SAMPLE & BUY	TECHNICAL DOCUMENTS	TOOLS & SOFTWARE	SUPPORT & COMMUNITY
SN54HC164	<a href="#">Click here</a>	<a href="#">Click here</a>	<a href="#">Click here</a>	<a href="#">Click here</a>	<a href="#">Click here</a>
SN74HC164	<a href="#">Click here</a>	<a href="#">Click here</a>	<a href="#">Click here</a>	<a href="#">Click here</a>	<a href="#">Click here</a>

### 13.3 Community Resources

The following links connect to TI community resources. Linked contents are provided "AS IS" by the respective contributors. They do not constitute TI specifications and do not necessarily reflect TI's views; see TI's [Terms of Use](#).

**TI E2E™ Online Community** *TI's Engineer-to-Engineer (E2E) Community*. Created to foster collaboration among engineers. At [e2e.ti.com](http://e2e.ti.com), you can ask questions, share knowledge, explore ideas and help solve problems with fellow engineers.

**Design Support** *TI's Design Support* Quickly find helpful E2E forums along with design support tools and contact information for technical support.

### 13.4 Trademarks

E2E is a trademark of Texas Instruments.  
All other trademarks are the property of their respective owners.

### 13.5 Electrostatic Discharge Caution



These devices have limited built-in ESD protection. The leads should be shorted together or the device placed in conductive foam during storage or handling to prevent electrostatic damage to the MOS gates.

### 13.6 Glossary

[SLYZ022](#) — *TI Glossary*.

This glossary lists and explains terms, acronyms, and definitions.

## 14 Mechanical, Packaging, and Orderable Information

The following pages include mechanical, packaging, and orderable information. This information is the most current data available for the designated devices. This data is subject to change without notice and revision of this document. For browser-based versions of this data sheet, refer to the left-hand navigation.

**PACKAGING INFORMATION**

Orderable Device	Status (1)	Package Type	Package Drawing	Pins	Package Qty	Eco Plan (2)	Lead/Ball Finish (6)	MSL Peak Temp (3)	Op Temp (°C)	Device Marking (4/5)	Samples
5962-8416201VCA	ACTIVE	CDIP	J	14	1	TBD	Call TI	N / A for Pkg Type	-55 to 125	5962-8416201VC A SNV54HC164J	<a href="#">Samples</a>
5962-8416201VDA	ACTIVE	CFP	W	14	25	TBD	Call TI	N / A for Pkg Type	-55 to 125	5962-8416201VD A SNV54HC164W	<a href="#">Samples</a>
84162012A	ACTIVE	LCCC	FK	20	1	TBD	POST-PLATE	N / A for Pkg Type	-55 to 125	84162012A SNJ54HC 164FK	<a href="#">Samples</a>
8416201CA	ACTIVE	CDIP	J	14	1	TBD	Call TI	N / A for Pkg Type	-55 to 125	8416201CA SNJ54HC164J	<a href="#">Samples</a>
SN54HC164J	ACTIVE	CDIP	J	14	1	TBD	Call TI	N / A for Pkg Type	-55 to 125	SN54HC164J	<a href="#">Samples</a>
SN74HC164D	ACTIVE	SOIC	D	14	50	Green (RoHS & no Sb/Br)	NIPDAU	Level-1-260C-UNLIM	-40 to 125	HC164	<a href="#">Samples</a>
SN74HC164DR	ACTIVE	SOIC	D	14	2500	Green (RoHS & no Sb/Br)	NIPDAU   SN	Level-1-260C-UNLIM	-40 to 125	HC164	<a href="#">Samples</a>
SN74HC164DRG3	ACTIVE	SOIC	D	14	2500	Green (RoHS & no Sb/Br)	SN	Level-1-260C-UNLIM	-40 to 125	HC164	<a href="#">Samples</a>
SN74HC164DRG4	ACTIVE	SOIC	D	14	2500	Green (RoHS & no Sb/Br)	NIPDAU	Level-1-260C-UNLIM	-40 to 125	HC164	<a href="#">Samples</a>
SN74HC164DT	ACTIVE	SOIC	D	14	250	Green (RoHS & no Sb/Br)	NIPDAU	Level-1-260C-UNLIM	-40 to 125	HC164	<a href="#">Samples</a>
SN74HC164N	ACTIVE	PDIP	N	14	25	Green (RoHS & no Sb/Br)	NIPDAU   SN	N / A for Pkg Type	-40 to 125	SN74HC164N	<a href="#">Samples</a>
SN74HC164NE4	ACTIVE	PDIP	N	14	25	Green (RoHS & no Sb/Br)	NIPDAU	N / A for Pkg Type	-40 to 125	SN74HC164N	<a href="#">Samples</a>
SN74HC164NSR	ACTIVE	SO	NS	14	2000	Green (RoHS & no Sb/Br)	NIPDAU	Level-1-260C-UNLIM	-40 to 125	HC164	<a href="#">Samples</a>
SN74HC164PW	ACTIVE	TSSOP	PW	14	90	Green (RoHS & no Sb/Br)	NIPDAU	Level-1-260C-UNLIM	-40 to 125	HC164	<a href="#">Samples</a>
SN74HC164PWR	ACTIVE	TSSOP	PW	14	2000	Green (RoHS & no Sb/Br)	NIPDAU   SN	Level-1-260C-UNLIM	-40 to 125	HC164	<a href="#">Samples</a>
SN74HC164PWRE4	ACTIVE	TSSOP	PW	14	2000	Green (RoHS & no Sb/Br)	NIPDAU	Level-1-260C-UNLIM	-40 to 125	HC164	<a href="#">Samples</a>

Orderable Device	Status (1)	Package Type	Package Drawing	Pins	Package Qty	Eco Plan (2)	Lead/Ball Finish (6)	MSL Peak Temp (3)	Op Temp (°C)	Device Marking (4/5)	Samples
SN74HC164PWRG4	ACTIVE	TSSOP	PW	14	2000	Green (RoHS & no Sb/Br)	NIPDAU	Level-1-260C-UNLIM	-40 to 125	HC164	<a href="#">Samples</a>
SN74HC164PWT	ACTIVE	TSSOP	PW	14	250	Green (RoHS & no Sb/Br)	NIPDAU	Level-1-260C-UNLIM	-40 to 125	HC164	<a href="#">Samples</a>
SNJ54HC164FK	ACTIVE	LCCC	FK	20	1	TBD	POST-PLATE	N / A for Pkg Type	-55 to 125	84162012A SNJ54HC 164FK	<a href="#">Samples</a>
SNJ54HC164J	ACTIVE	CDIP	J	14	1	TBD	Call TI	N / A for Pkg Type	-55 to 125	8416201CA SNJ54HC164J	<a href="#">Samples</a>
SNJ54HC164W	ACTIVE	CFP	W	14	1	TBD	Call TI	N / A for Pkg Type	-55 to 125	8416201DA SNJ54HC164W	<a href="#">Samples</a>

(1) The marketing status values are defined as follows:

**ACTIVE:** Product device recommended for new designs.

**LIFEBUY:** TI has announced that the device will be discontinued, and a lifetime-buy period is in effect.

**NRND:** Not recommended for new designs. Device is in production to support existing customers, but TI does not recommend using this part in a new design.

**PREVIEW:** Device has been announced but is not in production. Samples may or may not be available.

**OBSOLETE:** TI has discontinued the production of the device.

(2) **RoHS:** TI defines "RoHS" to mean semiconductor products that are compliant with the current EU RoHS requirements for all 10 RoHS substances, including the requirement that RoHS substance do not exceed 0.1% by weight in homogeneous materials. Where designed to be soldered at high temperatures, "RoHS" products are suitable for use in specified lead-free processes. TI may reference these types of products as "Pb-Free".

**RoHS Exempt:** TI defines "RoHS Exempt" to mean products that contain lead but are compliant with EU RoHS pursuant to a specific EU RoHS exemption.

**Green:** TI defines "Green" to mean the content of Chlorine (Cl) and Bromine (Br) based flame retardants meet JS709B low halogen requirements of <=1000ppm threshold. Antimony trioxide based flame retardants must also meet the <=1000ppm threshold requirement.

(3) MSL, Peak Temp. - The Moisture Sensitivity Level rating according to the JEDEC industry standard classifications, and peak solder temperature.

(4) There may be additional marking, which relates to the logo, the lot trace code information, or the environmental category on the device.

(5) Multiple Device Markings will be inside parentheses. Only one Device Marking contained in parentheses and separated by a "-" will appear on a device. If a line is indented then it is a continuation of the previous line and the two combined represent the entire Device Marking for that device.

(6) Lead/Ball Finish - Orderable Devices may have multiple material finish options. Finish options are separated by a vertical ruled line. Lead/Ball Finish values may wrap to two lines if the finish value exceeds the maximum column width.

**Important Information and Disclaimer:** The information provided on this page represents TI's knowledge and belief as of the date that it is provided. TI bases its knowledge and belief on information provided by third parties, and makes no representation or warranty as to the accuracy of such information. Efforts are underway to better integrate information from third parties. TI has taken and continues to take reasonable steps to provide representative and accurate information but may not have conducted destructive testing or chemical analysis on incoming materials and chemicals. TI and TI suppliers consider certain information to be proprietary, and thus CAS numbers and other limited information may not be available for release.

In no event shall TI's liability arising out of such information exceed the total purchase price of the TI part(s) at issue in this document sold by TI to Customer on an annual basis.

**OTHER QUALIFIED VERSIONS OF SN54HC164, SN54HC164-SP, SN74HC164 :**

- Catalog: [SN74HC164](#), [SN54HC164](#)
- Military: [SN54HC164](#)
- Space: [SN54HC164-SP](#)

NOTE: Qualified Version Definitions:

- Catalog - TI's standard catalog product
- Military - QML certified for Military and Defense Applications
- Space - Radiation tolerant, ceramic packaging and qualified for use in Space-based application

## TAPE AND REEL INFORMATION

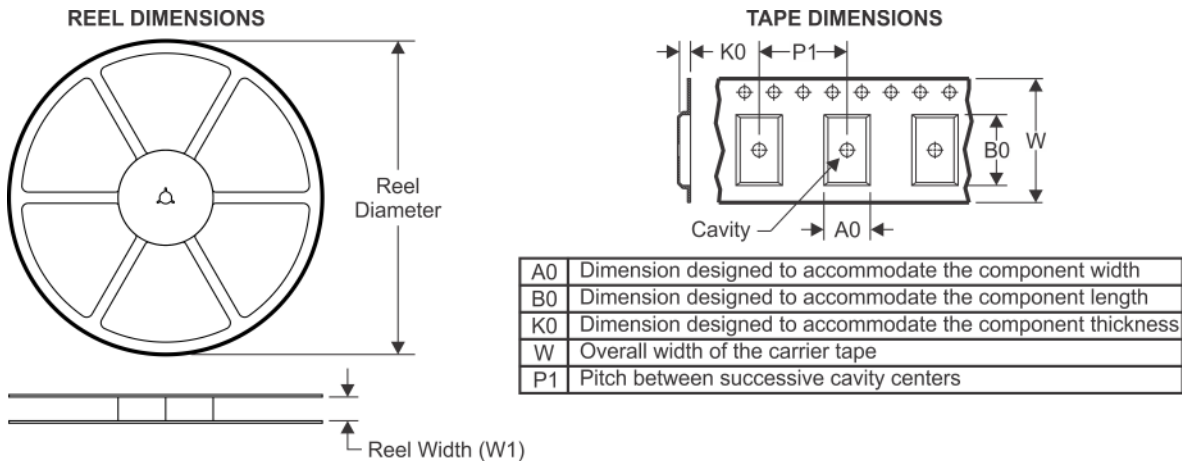

### QUADRANT ASSIGNMENTS FOR PIN 1 ORIENTATION IN TAPE



\*All dimensions are nominal

Device	Package Type	Package Drawing	Pins	SPQ	Reel Diameter (mm)	Reel Width W1 (mm)	A0 (mm)	B0 (mm)	K0 (mm)	P1 (mm)	W (mm)	Pin1 Quadrant
SN74HC164DR	SOIC	D	14	2500	330.0	16.8	6.5	9.5	2.1	8.0	16.0	Q1
SN74HC164DR	SOIC	D	14	2500	330.0	16.4	6.5	9.0	2.1	8.0	16.0	Q1
SN74HC164DRG3	SOIC	D	14	2500	330.0	16.8	6.5	9.5	2.1	8.0	16.0	Q1
SN74HC164DRG4	SOIC	D	14	2500	330.0	16.4	6.5	9.0	2.1	8.0	16.0	Q1
SN74HC164DRG4	SOIC	D	14	2500	330.0	16.4	6.5	9.0	2.1	8.0	16.0	Q1
SN74HC164DT	SOIC	D	14	250	330.0	16.4	6.5	9.0	2.1	8.0	16.0	Q1
SN74HC164NSR	SO	NS	14	2000	330.0	16.4	8.2	10.5	2.5	12.0	16.0	Q1
SN74HC164PWR	TSSOP	PW	14	2000	330.0	12.4	6.9	5.6	1.6	8.0	12.0	Q1
SN74HC164PWR	TSSOP	PW	14	2000	330.0	12.4	6.9	5.6	1.6	8.0	12.0	Q1
SN74HC164PWRG4	TSSOP	PW	14	2000	330.0	12.4	6.9	5.6	1.6	8.0	12.0	Q1
SN74HC164PWT	TSSOP	PW	14	250	330.0	12.4	6.9	5.6	1.6	8.0	12.0	Q1

**TAPE AND REEL BOX DIMENSIONS**



\*All dimensions are nominal

Device	Package Type	Package Drawing	Pins	SPQ	Length (mm)	Width (mm)	Height (mm)
SN74HC164DR	SOIC	D	14	2500	364.0	364.0	27.0
SN74HC164DR	SOIC	D	14	2500	367.0	367.0	38.0
SN74HC164DRG3	SOIC	D	14	2500	364.0	364.0	27.0
SN74HC164DRG4	SOIC	D	14	2500	333.2	345.9	28.6
SN74HC164DRG4	SOIC	D	14	2500	367.0	367.0	38.0
SN74HC164DT	SOIC	D	14	250	210.0	185.0	35.0
SN74HC164NSR	SO	NS	14	2000	367.0	367.0	38.0
SN74HC164PWR	TSSOP	PW	14	2000	367.0	367.0	35.0
SN74HC164PWR	TSSOP	PW	14	2000	364.0	364.0	27.0
SN74HC164PWRG4	TSSOP	PW	14	2000	367.0	367.0	35.0
SN74HC164PWT	TSSOP	PW	14	250	367.0	367.0	35.0

FK (S-CQCC-N\*\*)

LEADLESS CERAMIC CHIP CARRIER

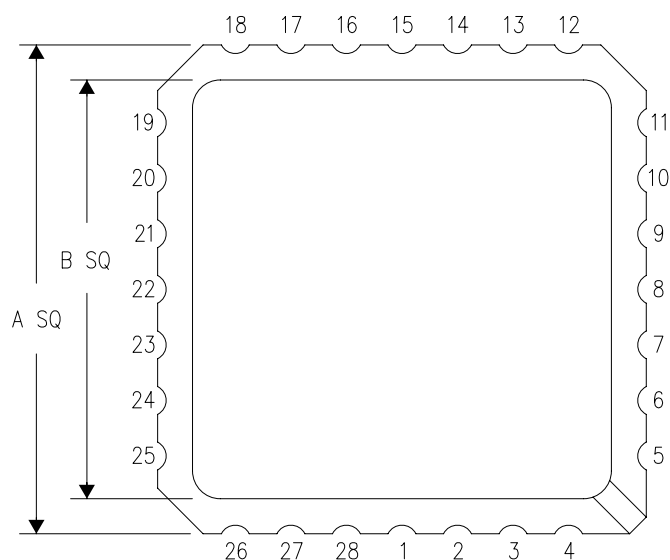
28 TERMINAL SHOWN



NO. OF TERMINALS **	A		B	
	MIN	MAX	MIN	MAX
20	0.342 (8,69)	0.358 (9,09)	0.307 (7,80)	0.358 (9,09)
28	0.442 (11,23)	0.458 (11,63)	0.406 (10,31)	0.458 (11,63)
44	0.640 (16,26)	0.660 (16,76)	0.495 (12,58)	0.560 (14,22)
52	0.740 (18,78)	0.761 (19,32)	0.495 (12,58)	0.560 (14,22)
68	0.938 (23,83)	0.962 (24,43)	0.850 (21,6)	0.858 (21,8)
84	1.141 (28,99)	1.165 (29,59)	1.047 (26,6)	1.063 (27,0)

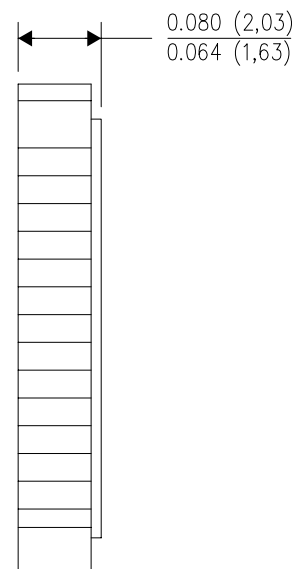
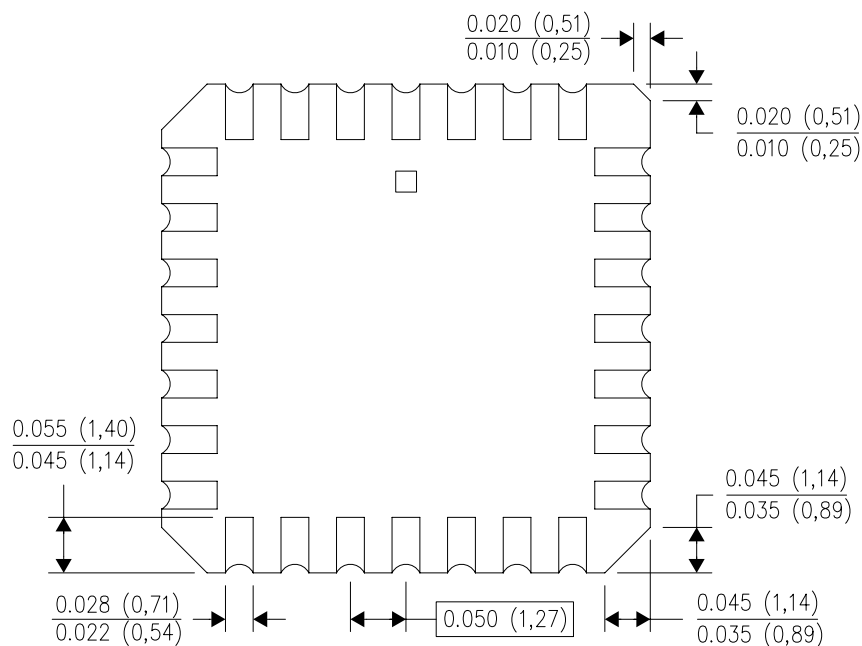

4040140/D 01/11

- NOTES:
- All linear dimensions are in inches (millimeters).
  - This drawing is subject to change without notice.
  - This package can be hermetically sealed with a metal lid.
  - Falls within JEDEC MS-004



# MECHANICAL DATA

NS (R-PDSO-G\*\*)

PLASTIC SMALL-OUTLINE PACKAGE

14-PINS SHOWN



- NOTES:
- A. All linear dimensions are in millimeters.
  - B. This drawing is subject to change without notice.
  - C. Body dimensions do not include mold flash or protrusion, not to exceed 0,15.

N (R-PDIP-T\*\*)

PLASTIC DUAL-IN-LINE PACKAGE

16 PINS SHOWN



- NOTES:
- A. All linear dimensions are in inches (millimeters).
  - B. This drawing is subject to change without notice.
  - C Falls within JEDEC MS-001, except 18 and 20 pin minimum body length (Dim A).
  - D The 20 pin end lead shoulder width is a vendor option, either half or full width.

4040049/E 12/2002

J 14

**GENERIC PACKAGE VIEW**  
**CDIP - 5.08 mm max height**  
CERAMIC DUAL IN LINE PACKAGE

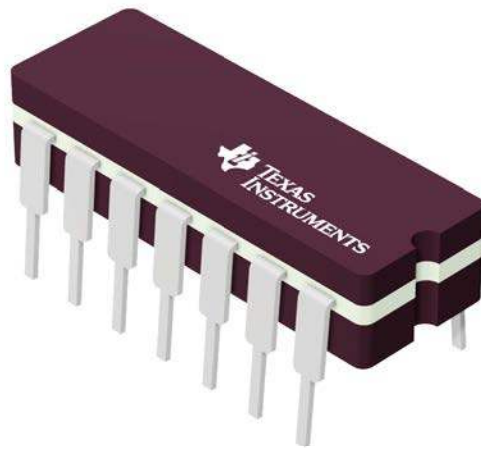

Images above are just a representation of the package family, actual package may vary.  
Refer to the product data sheet for package details.

4040083-5/G

J0014A



# PACKAGE OUTLINE

CDIP - 5.08 mm max height

CERAMIC DUAL IN LINE PACKAGE



NOTES:

1. All controlling linear dimensions are in inches. Dimensions in brackets are in millimeters. Any dimension in brackets or parenthesis are for reference only. Dimensioning and tolerancing per ASME Y14.5M.
2. This drawing is subject to change without notice.
3. This package is hermetically sealed with a ceramic lid using glass frit.
4. Index point is provided on cap for terminal identification only and on press ceramic glass frit seal only.
5. Falls within MIL-STD-1835 and GDIP1-T14.

# EXAMPLE BOARD LAYOUT

J0014A

CDIP - 5.08 mm max height

CERAMIC DUAL IN LINE PACKAGE



LAND PATTERN EXAMPLE  
NON-SOLDER MASK DEFINED  
SCALE: 5X



4214771/A 05/2017

D (R-PDSO-G14)

PLASTIC SMALL OUTLINE



4040047-5/M 06/11

- NOTES:
- A. All linear dimensions are in inches (millimeters).
  - B. This drawing is subject to change without notice.
  - $\triangle C$  Body length does not include mold flash, protrusions, or gate burrs. Mold flash, protrusions, or gate burrs shall not exceed 0.006 (0,15) each side.
  - $\triangle D$  Body width does not include interlead flash. Interlead flash shall not exceed 0.017 (0,43) each side.
  - E. Reference JEDEC MS-012 variation AB.

D (R-PDSO-G14)

PLASTIC SMALL OUTLINE

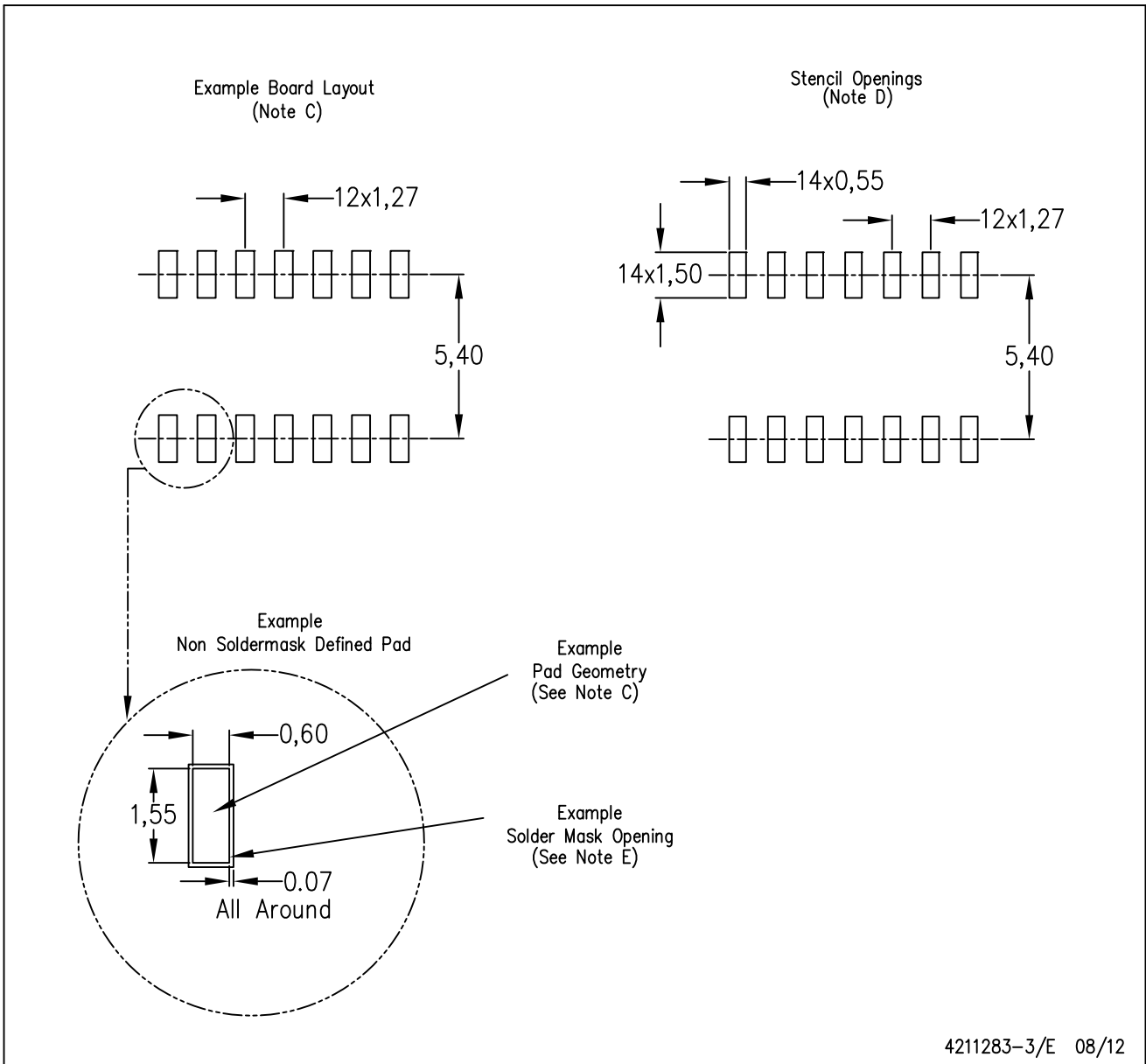

4211283-3/E 08/12

- NOTES:
- A. All linear dimensions are in millimeters.
  - B. This drawing is subject to change without notice.
  - C. Publication IPC-7351 is recommended for alternate designs.
  - D. Laser cutting apertures with trapezoidal walls and also rounding corners will offer better paste release. Customers should contact their board assembly site for stencil design recommendations. Refer to IPC-7525 for other stencil recommendations.
  - E. Customers should contact their board fabrication site for solder mask tolerances between and around signal pads.





PW (R-PDSO-G14)

PLASTIC SMALL OUTLINE

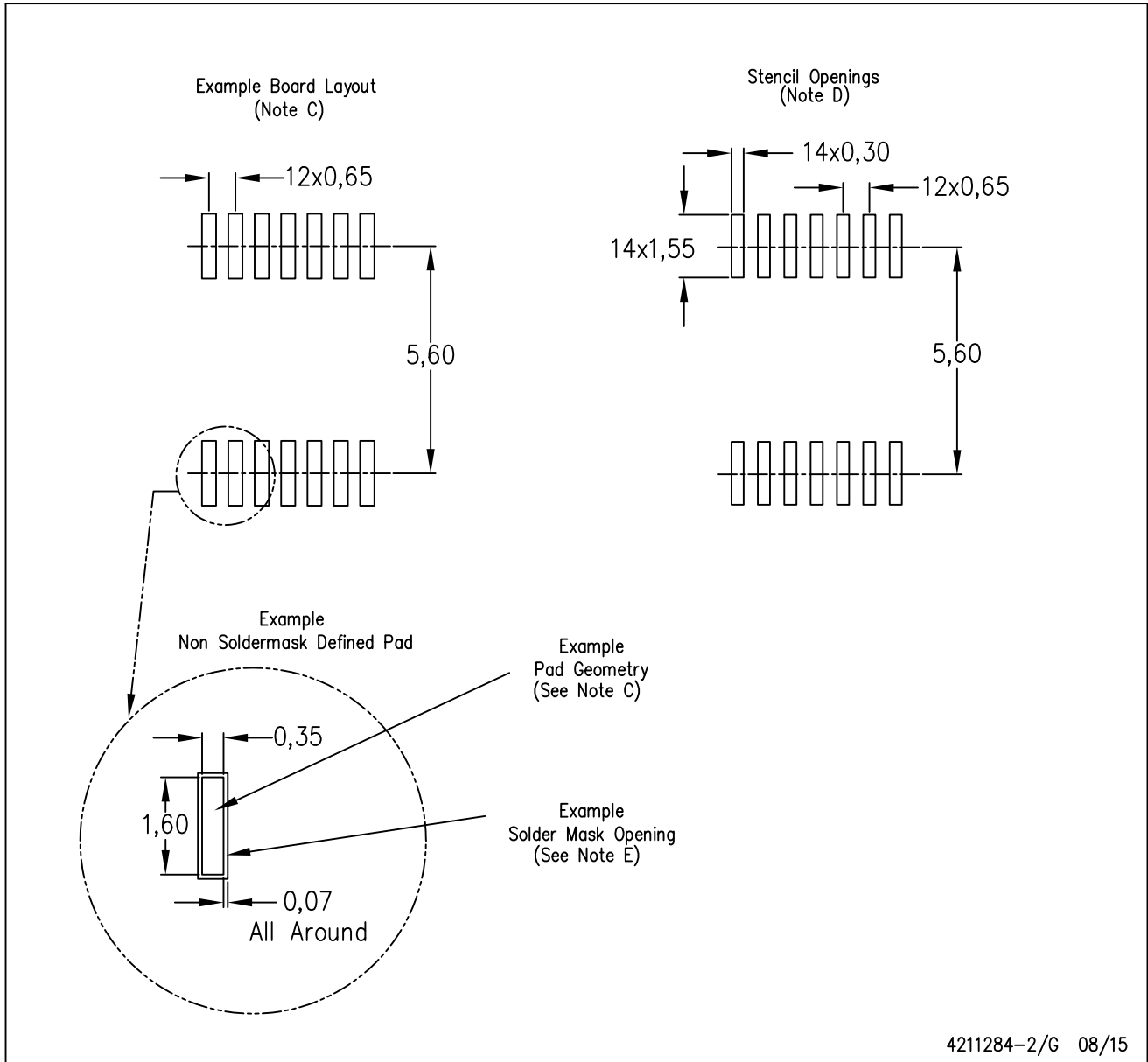

- NOTES:
- All linear dimensions are in millimeters.
  - This drawing is subject to change without notice.
  - Publication IPC-7351 is recommended for alternate designs.
  - Laser cutting apertures with trapezoidal walls and also rounding corners will offer better paste release. Customers should contact their board assembly site for stencil design recommendations. Refer to IPC-7525 for other stencil recommendations.
  - Customers should contact their board fabrication site for solder mask tolerances between and around signal pads.

W (R-GDFP-F14)

CERAMIC DUAL FLATPACK

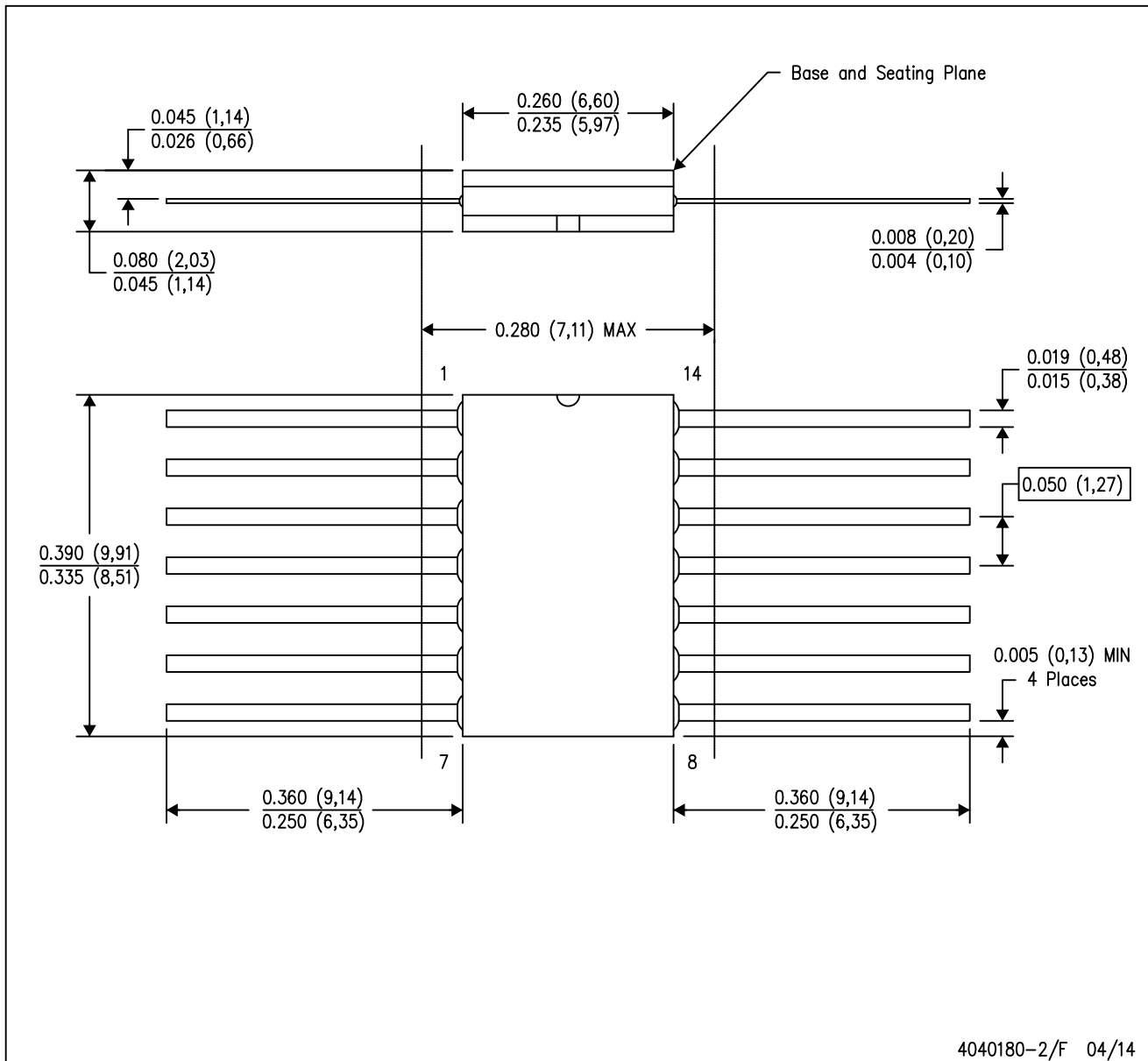

4040180-2/F 04/14

- NOTES:
- A. All linear dimensions are in inches (millimeters).
  - B. This drawing is subject to change without notice.
  - C. This package can be hermetically sealed with a ceramic lid using glass frit.
  - D. Index point is provided on cap for terminal identification only.
  - E. Falls within MIL STD 1835 GDFP1-F14

## IMPORTANT NOTICE AND DISCLAIMER

TI PROVIDES TECHNICAL AND RELIABILITY DATA (INCLUDING DATASHEETS), DESIGN RESOURCES (INCLUDING REFERENCE DESIGNS), APPLICATION OR OTHER DESIGN ADVICE, WEB TOOLS, SAFETY INFORMATION, AND OTHER RESOURCES "AS IS" AND WITH ALL FAULTS, AND DISCLAIMS ALL WARRANTIES, EXPRESS AND IMPLIED, INCLUDING WITHOUT LIMITATION ANY IMPLIED WARRANTIES OF MERCHANTABILITY, FITNESS FOR A PARTICULAR PURPOSE OR NON-INFRINGEMENT OF THIRD PARTY INTELLECTUAL PROPERTY RIGHTS.

These resources are intended for skilled developers designing with TI products. You are solely responsible for (1) selecting the appropriate TI products for your application, (2) designing, validating and testing your application, and (3) ensuring your application meets applicable standards, and any other safety, security, or other requirements. These resources are subject to change without notice. TI grants you permission to use these resources only for development of an application that uses the TI products described in the resource. Other reproduction and display of these resources is prohibited. No license is granted to any other TI intellectual property right or to any third party intellectual property right. TI disclaims responsibility for, and you will fully indemnify TI and its representatives against, any claims, damages, costs, losses, and liabilities arising out of your use of these resources.

TI's products are provided subject to TI's Terms of Sale ([www.ti.com/legal/termsofsale.html](http://www.ti.com/legal/termsofsale.html)) or other applicable terms available either on [ti.com](http://ti.com) or provided in conjunction with such TI products. TI's provision of these resources does not expand or otherwise alter TI's applicable warranties or warranty disclaimers for TI products.

Mailing Address: Texas Instruments, Post Office Box 655303, Dallas, Texas 75265  
Copyright © 2020, Texas Instruments Incorporated