

MG06400D-BN4MM Series 400A Dual IGBT



Agency Approvals

AGENCY	AGENCY FILE NUMBER
	E71639

Features

- High short circuit capability, self limiting short circuit current
- $V_{CE(sat)}$ with positive temperature coefficient
- Fast switching and short tail current
- Free wheeling diodes with fast and soft reverse recovery
- Low switching losses

Applications

- Motor drives
- Inverter
- Converter
- SMPS and UPS
- Welder
- Induction Heating

Module Characteristics ($T_c = 25^\circ\text{C}$, unless otherwise specified)

Symbol	Parameters	Test Conditions	Min	Typ	Max	Unit
$T_{J(max)}$	Max. Junction Temperature				175	$^\circ\text{C}$
$T_{J(op)}$	Operating Temperature		-40		150	$^\circ\text{C}$
T_{stg}	Storage Temperature		-40		125	$^\circ\text{C}$
V_{isol}	Insulation Test Voltage	AC, t=1min		3000		V
CTI	Comparative Tracking Index	Module case exposed to 0.1% ammonium chloride solution per UL and IEC standards	350			V
Torque	Module-to-Sink	Recommended (M6)	3		5	N·m
Torque	Module Electrodes	Recommended (M6)	2.5		5	N·m
Weight				320		g

Absolute Maximum Ratings ($T_c = 25^\circ\text{C}$, unless otherwise specified)

Symbol	Parameters	Test Conditions	Values	Unit
IGBT				
V_{CES}	Collector - Emitter Voltage	$T_j=25^\circ\text{C}$	600	V
V_{GES}	Gate - Emitter Voltage		± 20	V
I_c	DC Collector Current	$T_c=25^\circ\text{C}$	500	A
		$T_c=70^\circ\text{C}$	400	A
I_{CM}	Repetitive Peak Collector Current	$t_p=1\text{ms}$	800	A
P_{tot}	Power Dissipation Per IGBT		1250	W
Diode				
V_{RRM}	Repetitive Reverse Voltage	$T_j=25^\circ\text{C}$	600	V
$I_{F(AV)}$	Average Forward Current	$T_c=25^\circ\text{C}$	500	A
		$T_c=70^\circ\text{C}$	400	A
I_{FRM}	Repetitive Peak Forward Current	$t_p=1\text{ms}$	800	A
I^2t		$T_j=125^\circ\text{C}$, t=10ms, $V_R=0\text{V}$	10000	A^2s

Life Support Note:

Not Intended for Use in Life Support or Life Saving Applications

The products shown herein are not designed for use in life sustaining or life saving applications unless otherwise expressly indicated.

Electrical and Thermal Specifications ($T_c = 25^\circ\text{C}$, unless otherwise specified)

Symbol	Parameters	Test Conditions	Min	Typ	Max	Unit	
IGBT							
$V_{GE(th)}$	Gate - Emitter Threshold Voltage	$V_{CE}=V_{GE}, I_C=6.4\text{mA}$	4.9	5.8	6.5	V	
$V_{CE(sat)}$	Collector - Emitter Saturation Voltage	$I_C=400\text{A}, V_{GE}=15\text{V}, T_J=25^\circ\text{C}$		1.45		V	
		$I_C=400\text{A}, V_{GE}=15\text{V}, T_J=125^\circ\text{C}$		1.6		V	
I_{CES}	Collector Leakage Current	$V_{CE}=600\text{V}, V_{GE}=0\text{V}, T_J=25^\circ\text{C}$			1.0	mA	
		$V_{CE}=600\text{V}, V_{GE}=0\text{V}, T_J=125^\circ\text{C}$			5	mA	
I_{GES}	Gate Leakage Current	$V_{CE}=0\text{V}, V_{GE}=\pm 15\text{V}, T_J=125^\circ\text{C}$	-400		400	μA	
R_{Gint}	Intergrated Gate Resistor			1.0		Ω	
Q_{ge}	Gate Charge	$V_{CE}=300\text{V}, I_C=400\text{A}, V_{GE}=\pm 15\text{V}$		4.3		μC	
C_{ies}	Input Capacitance	$V_{CE}=25\text{V}, V_{GE}=0\text{V}, f=1\text{MHz}$		26		nF	
C_{res}	Reverse Transfer Capacitance			0.76		nF	
$t_{d(on)}$	Turn - on Delay Time	Inductive Load $V_{CC}=300\text{V}$ $I_C=400\text{A}$ $R_G=1.5\Omega$ $V_{GE}=\pm 15\text{V}$	$T_J=25^\circ\text{C}$		110		ns
			$T_J=125^\circ\text{C}$		120		ns
t_r	Rise Time		$T_J=25^\circ\text{C}$		50		ns
			$T_J=125^\circ\text{C}$		60		ns
$t_{d(off)}$	Turn - off Delay Time		$T_J=25^\circ\text{C}$		490		ns
			$T_J=125^\circ\text{C}$		520		ns
t_f	Fall Time		$T_J=25^\circ\text{C}$		60		ns
			$T_J=125^\circ\text{C}$		70		ns
E_{on}	Turn - on Energy		$T_J=25^\circ\text{C}$		2.1		mJ
			$T_J=125^\circ\text{C}$		3.2		mJ
E_{off}	Turn - off Energy	$T_J=25^\circ\text{C}$		12		mJ	
		$T_J=125^\circ\text{C}$		15		mJ	
I_{SC}	Short Circuit Current	$t_{psc} \leq 6\mu\text{s}, V_{GE}=15\text{V}$		2000		A	
		$T_J=125^\circ\text{C}, V_{CC}=360\text{V}$					
R_{thJC}	Junction-to-Case Thermal Resistance (Per IGBT)				0.12	K/W	
Diode							
V_F	Forward Voltage	$I_F=400\text{A}, V_{GE}=0\text{V}, T_J=25^\circ\text{C}$		1.55		V	
		$I_F=400\text{A}, V_{GE}=0\text{V}, T_J=125^\circ\text{C}$		1.50		V	
I_{RRM}	Max. Reverse Recovery Current	$I_F=400\text{A}, V_R=300\text{V}$		330		A	
Q_{rr}	Reverse Recovery Charge	$d_f/dt=-7000\text{A}/\mu\text{s}$		29.0		μC	
E_{rec}	Reverse Recovery Energy	$T_J=125^\circ\text{C}$		7.4		mJ	
R_{thJCD}	Junction-to-Case Thermal Resistance (Per Diode)				0.22	K/W	

Figure 1: Typical Output Characteristics

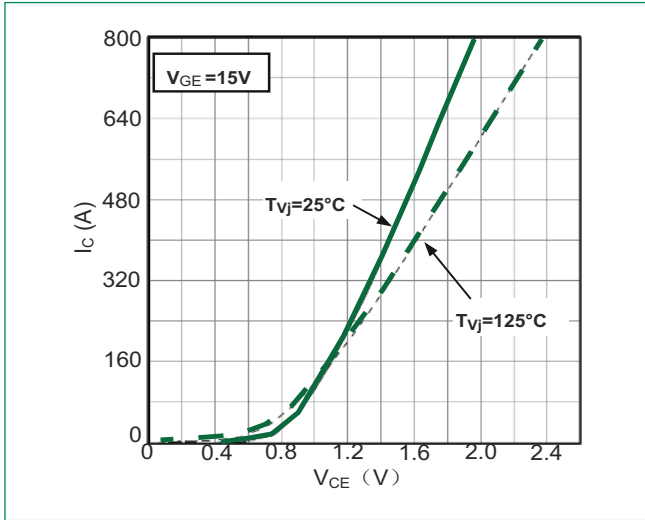

Figure 2: Typical Output Characteristics

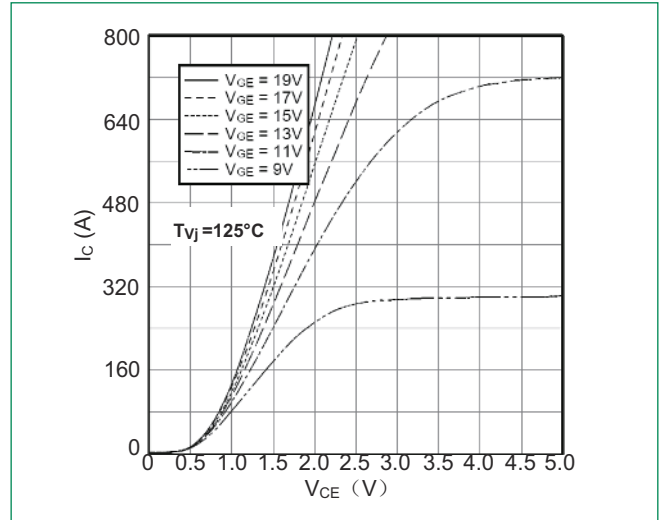

Figure 3: Typical Transfer characteristics

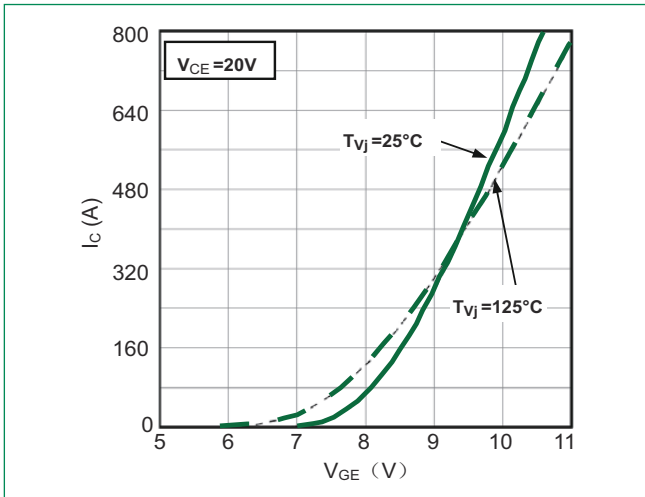

Figure 4: Switching Energy vs. Gate Resistor

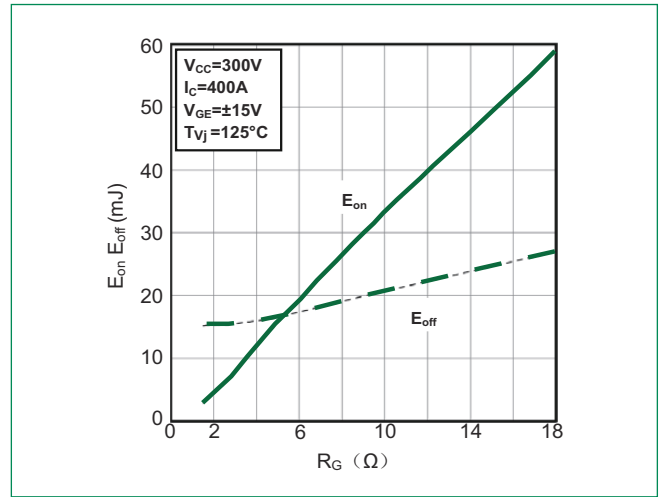

Figure 5: Switching Energy vs. Collector Current

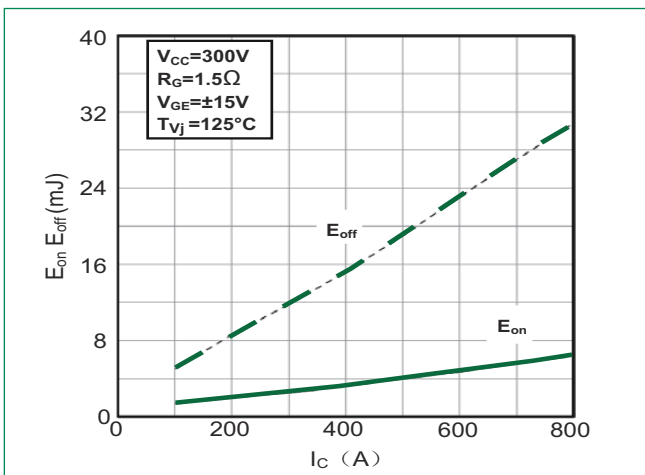

Figure 6: Reverse Biased Safe Operating Area

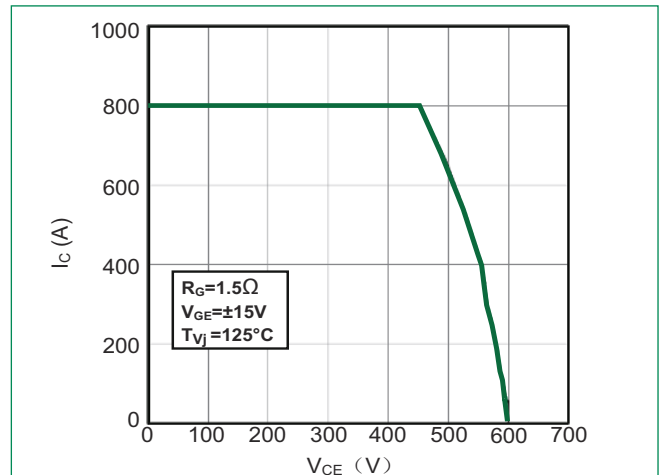

Figure 7: Diode Forward Characteristics

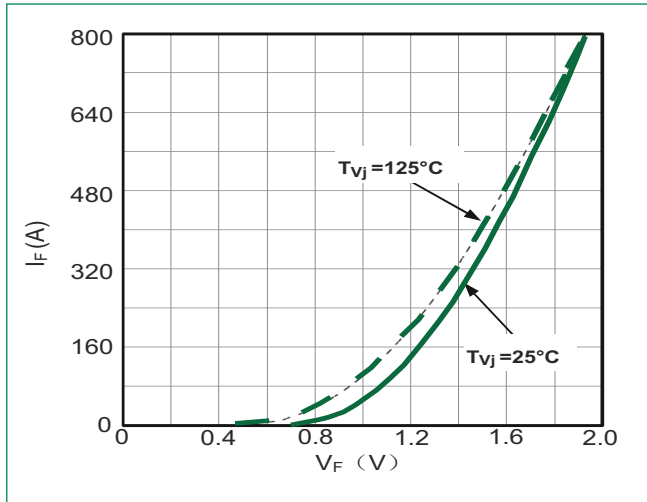

Figure 8: Switching Energy vs. Gate Resistort

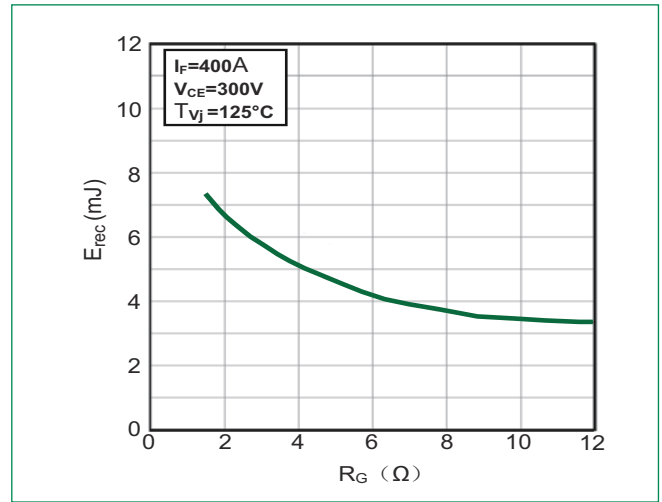

Figure 9: Switching Energy vs. Forward Current

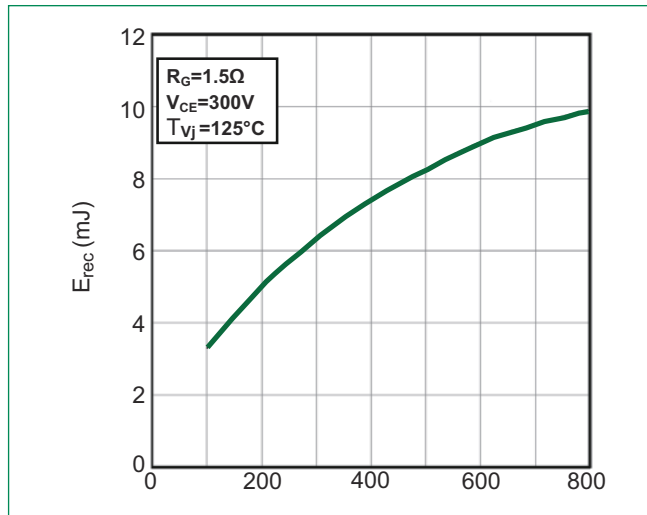
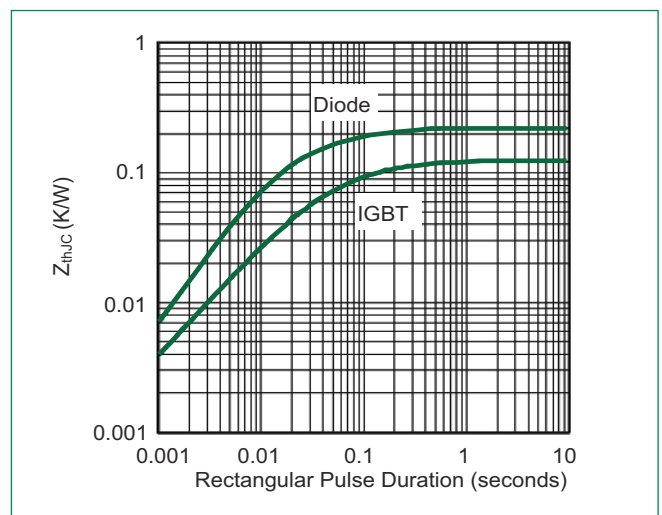
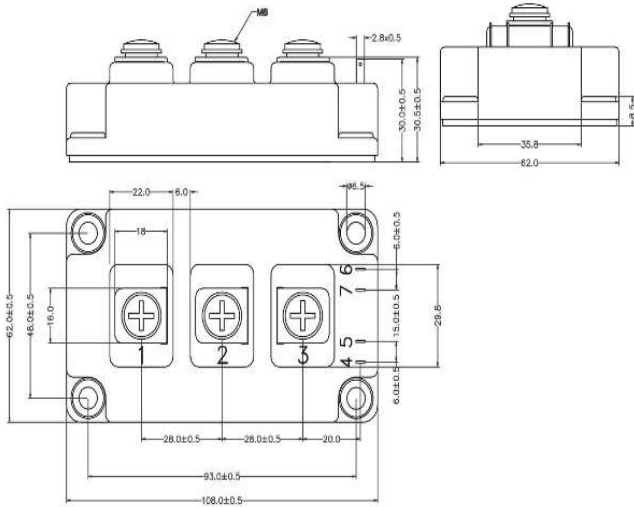

Figure 10: Transient Thermal Impedance



Dimensions-Package D



Circuit Diagram and Pin Assignment

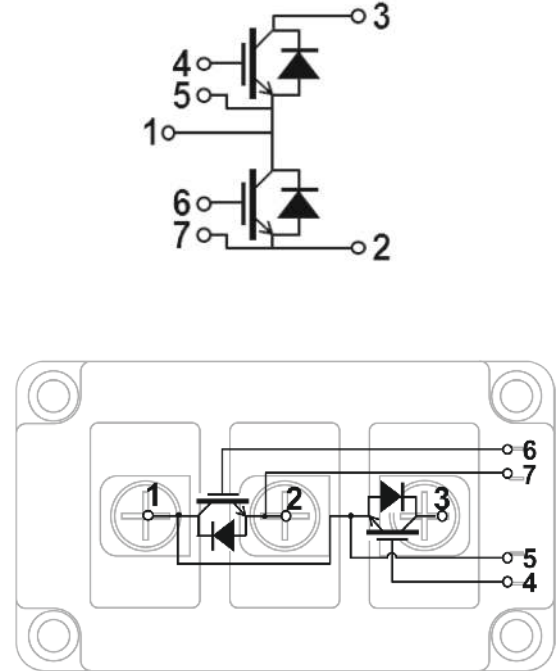

Packing Options

Part Number	Marking	Weight	Packing Mode	M.O.Q
MG06400D-BN4MM	MG06400D-BN4MM	320g	Bulk Pack	60

Part Numbering System

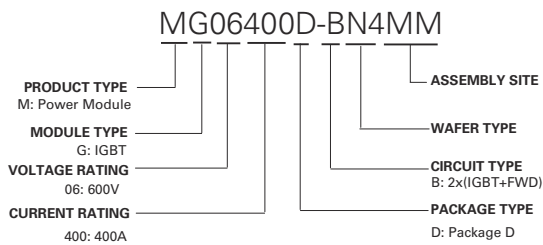

Part Marking System

