

## CDBA340L-HF

**Reverse Voltage: 40 Volts**  
**Forward Current: 3.0 Amp**  
**RoHS Device**  
**Halogen free**

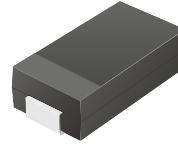

### Features

- Low Profile surface mount applications in order to optimize board space.
- Low power loss, high efficiency.
- High current capability, low forward voltage drop.
- High surge capability.
- Guard ring for overvoltage protection.
- Ultra high-speed switching.
- Silicon epitaxial planar chip, metal silicon junction.

### Mechanical data

- Case: JEDEC DO-214AC / SMA, molded plastic.
- Epoxy: UL 94V-0 rate flame retardant.
- Terminals: Solder plated, Solderable per MIL-STD-750, method 2026.
- Polarity: Indicated by cathode band.
- Mounting position: Any.
- Weight: 0.055 grams

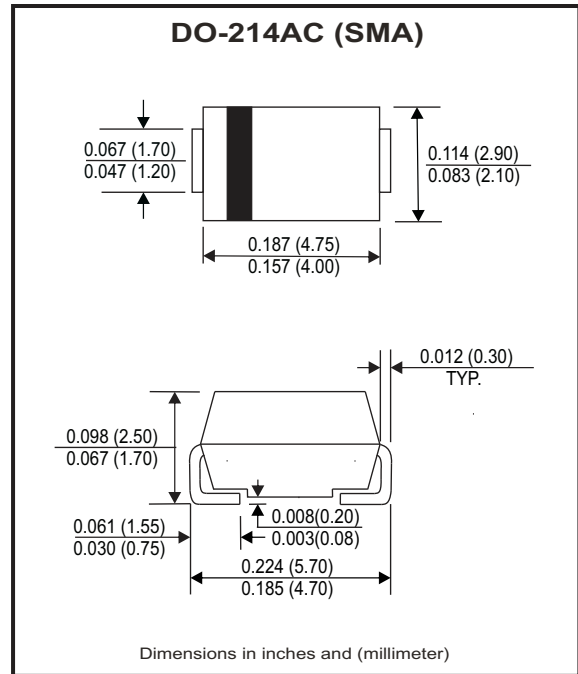

### Maximum Ratings and Electrical Characteristics

Ratings at Ta=25°C unless otherwise noted.  
 Single phase, half wave, 60Hz, resistive or inductive loaded.  
 For capacitive load, derate current by 20% .

Parameter	Symbol	CDBA340L-HF	Unit
Max. Recurrent Peak Reverse Voltage	V <sub>RRM</sub>	40	V
Max. RMS Voltage	V <sub>RMS</sub>	28	V
Max. DC Blocking Voltage	V <sub>DC</sub>	40	V
Max. Instantaneous Forward Voltage @3.0A, T <sub>A</sub> =25°C	V <sub>F</sub>	0.40	V
Max. Forward Rectified Current (See Fig.1)	I <sub>O</sub>	3.0	A
Max. Forward Surge Current, 8.3ms single half sine-wave superimposed on rated load (JEDEC method)	I <sub>FSM</sub>	80	A
Max. Reverse Current	I <sub>R</sub>	V <sub>R</sub> =V <sub>RRM</sub> T <sub>J</sub> =25°C	1.0
		V <sub>R</sub> =V <sub>RRM</sub> T <sub>J</sub> =100°C	20
Typical Thermal Resistance (Note 1)	R <sub>θJA</sub>	50	°C/W
Typical Diode Junction Capacitance(Note 2)	C <sub>J</sub>	300	pF
Operating Temperature Range	T <sub>J</sub>	-50 to +100	°C
Storage Temperature Range	T <sub>STG</sub>	-50 to +150	°C

NOTES:

1. Thermal resistance from junction to ambient.
2. F=1MHz and applied 4V DC reverse Voltage.

Company reserves the right to improve product design , functions and reliability without notice.

REV: C

## RATING AND CHARACTERISTIC CURVES (CDBA340L-HF)

Fig.1 - Typical Forward Current Derating Curve

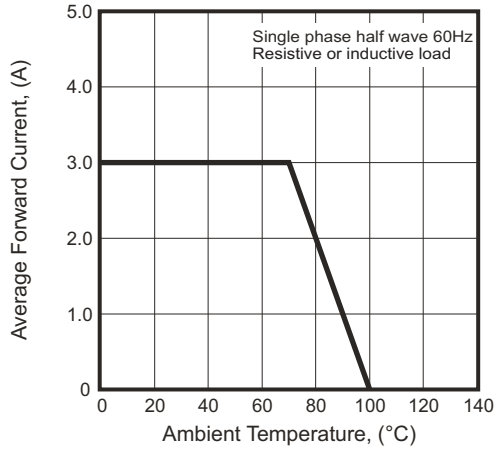

Fig.2 - Typical Forward Characteristics

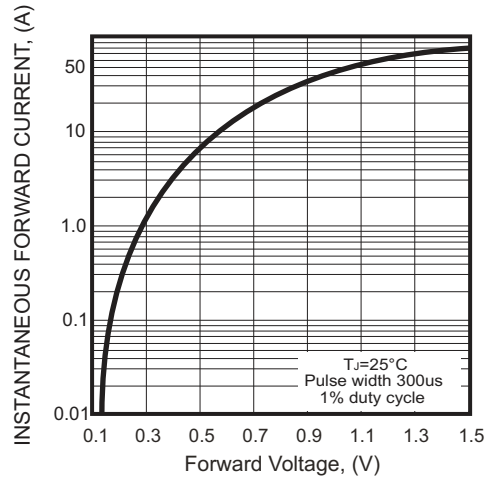

Fig.3 - Maximum Non-repetitive Forward Surge Current

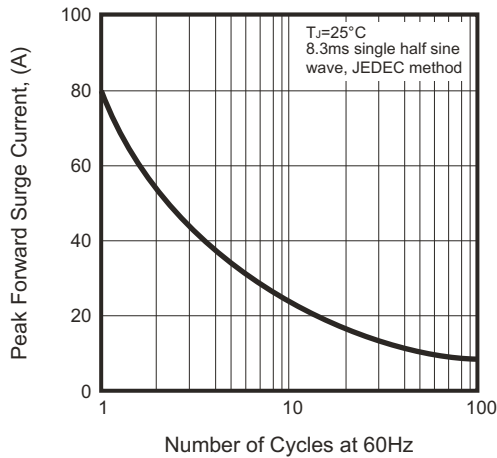

Fig.4 - Typical Junction Capacitance

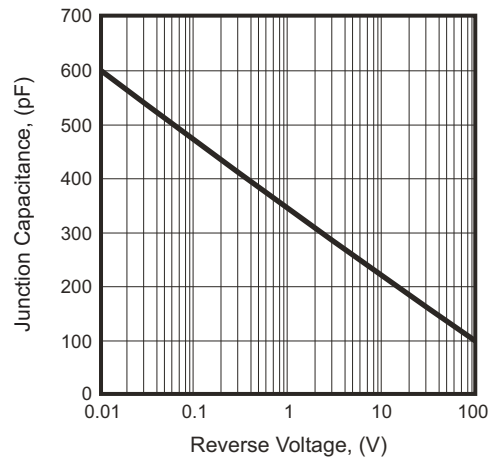
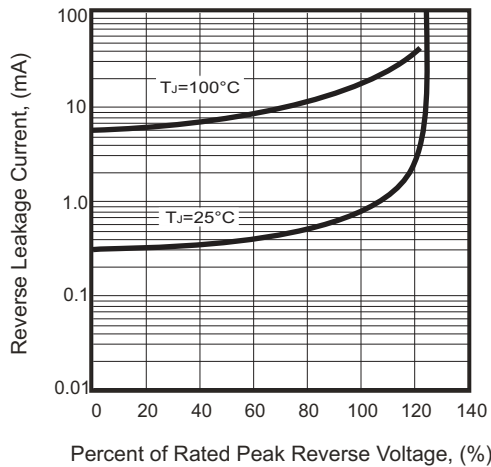
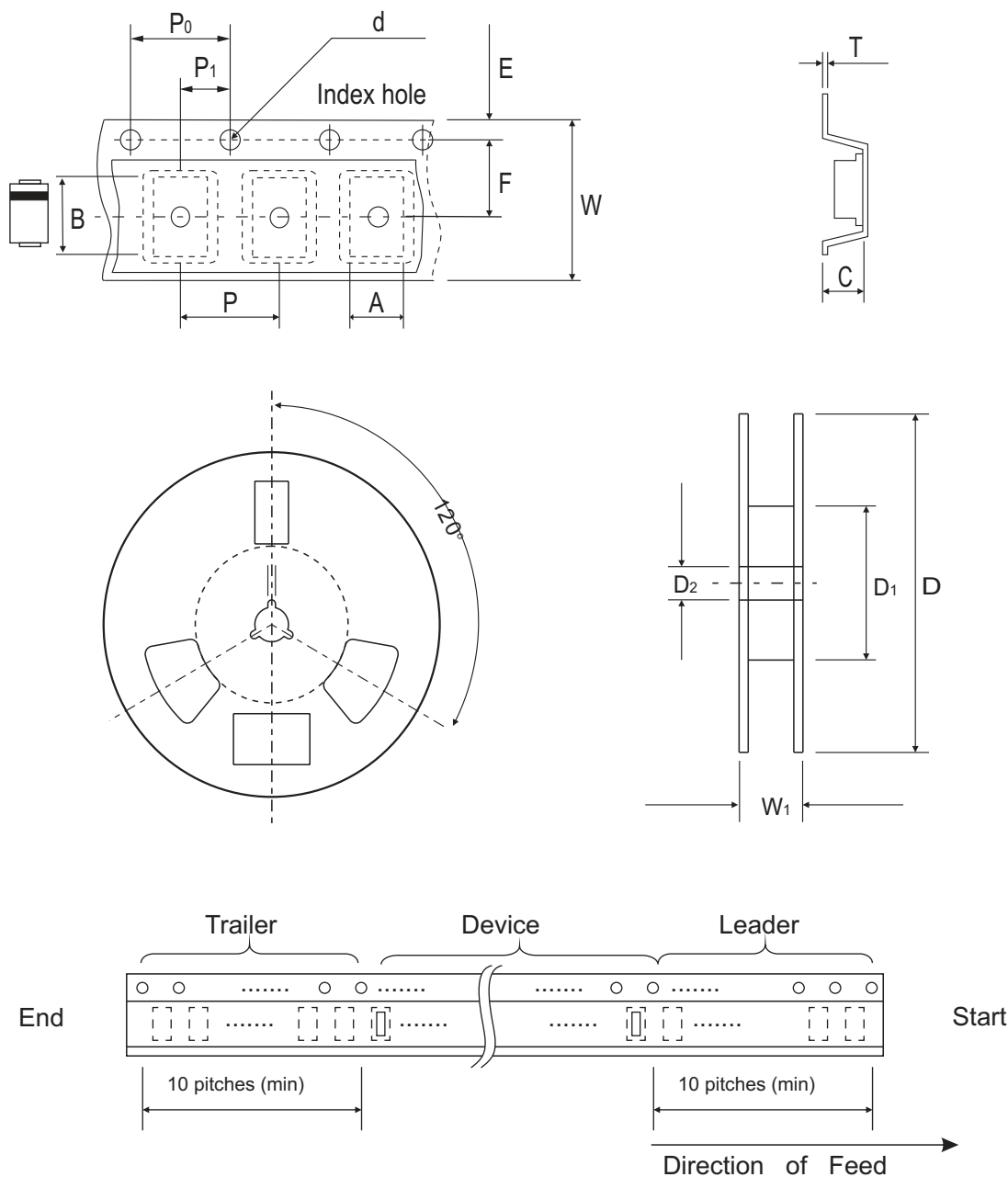

Fig.5 - Typical Reverse Characteristics



## Reel Taping Specification



DO-214AC (SMA)	SYMBOL	A	B	C	d	D	D1	D2
	(mm)	2.70 ± 0.10	5.30 ± 0.10	2.66 ± 0.10	1.50 ± 0.10	330 ± 2.00	62.0 MIN.	13.50 ± 0.50
	(inch)	0.106 ± 0.004	0.209 ± 0.004	0.105 ± 0.004	0.059 ± 0.004	12.99 ± 0.079	2.441 MIN.	0.531 ± 0.020

DO-214AC (SMA)	SYMBOL	E	F	P	P0	P1	T	W	W1
	(mm)	1.75 ± 0.10	5.50 ± 0.10	4.00 ± 0.10	4.00 ± 0.10	2.00 ± 0.10	0.60 ± 0.10	12.0 ± 0.30	18.40 ± 1.00
	(inch)	0.069 ± 0.004	0.217 ± 0.004	0.157 ± 0.004	0.157 ± 0.004	0.079 ± 0.004	0.236 ± 0.004	0.472 ± 0.012	0.724 ± 0.039

Company reserves the right to improve product design, functions and reliability without notice.

REV: C

## Marking Code

Part Number	Marking Code
CDBA340L-HF	SL34

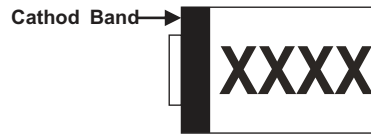

XXXX = Product type marking code

## Suggested PAD Layout

SIZE	DO-214AC (SMA)	
	(mm)	(inch)
A	4.00	0.157
B	2.50	0.100
C	1.70	0.068
D	6.50	0.256
E	1.50	0.060

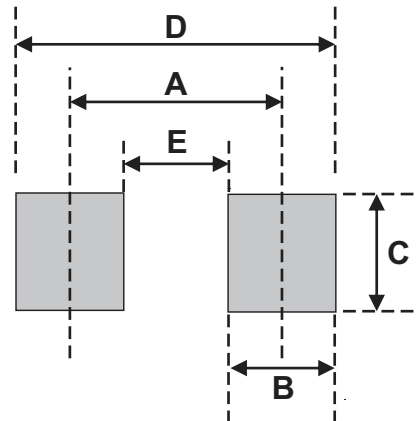

## Standard Packaging

Case Type	REEL PACK	
	REEL ( pcs )	Reel Size (inch)
DO-214AC (SMA)	5,000	13