

AM1064-1 – Amplifier

DC to 8 GHz Gain Block

Description

The AM1064-1 is a high dynamic range DC-coupled amplifier covering up to 8 GHz. The device exhibits a moderate positive gain-slope, providing frequency equalization useful in many broadband applications. With internal 50Ω matching and packaged in a 3mm QFN or a shielded module, the AM1064-1 represents a compact total PCB footprint.

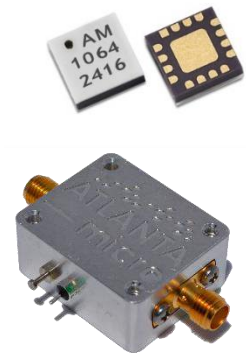

Features

- 21 dB Gain
- 2.0 dB Noise Figure
- +32 dBm OIP3
- +18 dBm P1dB
- +3.3V or +5.0V Operation
- 3mm QFN
- -40C to +85C Operation

Functional Diagram

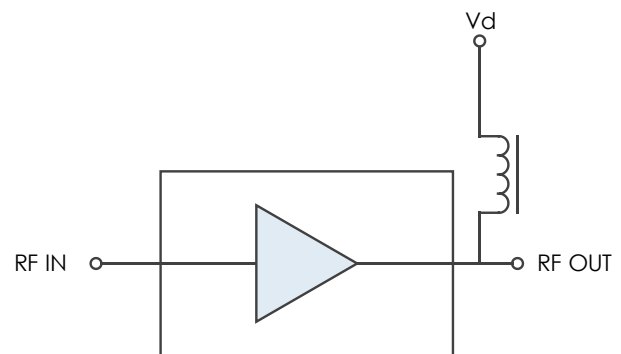

Characteristic Performance

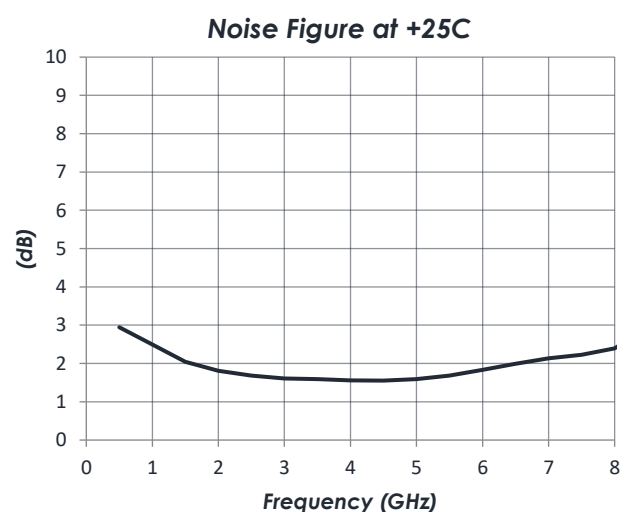
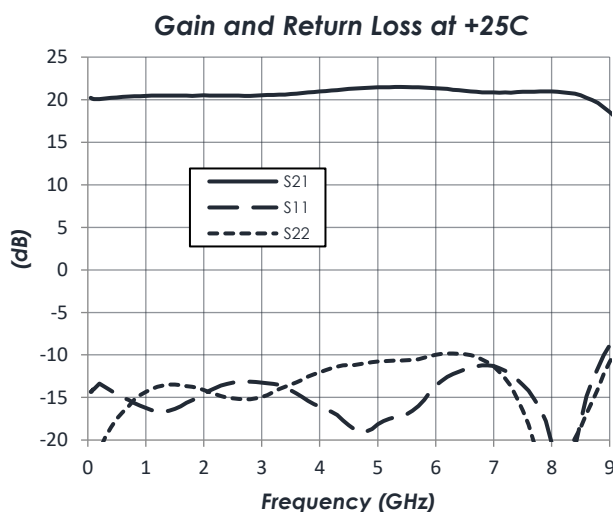

Table of Contents

Description	1	Thermal Information	4
Features	1	DC Electrical Characteristics	5
Functional Diagram	1	RF Performance	5
Characteristic Performance	1	Typical Performance	6
Revision History	2	Typical Application	9
Pin Layout and Definitions	3	Part Ordering Details	10
Specifications	4	Related Parts	10
Absolute Maximum Ratings	4	Evaluation PC Board	10
Handling Information	4	Component Compliance Information	11
Recommended Operating Conditions	4		

Revision History

Date	Revision Number	Notes
April 24, 2017	8	Features Updated
July 18, 2018	9	Updated to new datasheet format. More comprehensive part data added.
November 27, 2018	10	Thermal Resistance Corrected
March 28, 2019	11	Power vs. VDD Comparison Added
April 30, 2019	12	AM1064-1 and AM1064-2 Datasheets Split
June 6, 2019	12A	Component Compliance Information Updated
July 11, 2019	13	Part Ordering Information Added. New RF Shielded Module Available.
November 26, 2019	13A	Updated Description to include shielded module packaging
March 27, 2020	14	Updated package information. Updated module drawing showing input and output locations.
November 10, 2020	15	Package and module information moved to main product page. IP2 data added.

AM1064-1 – Amplifier

DC to 8 GHz Gain Block



Pin Layout and Definitions

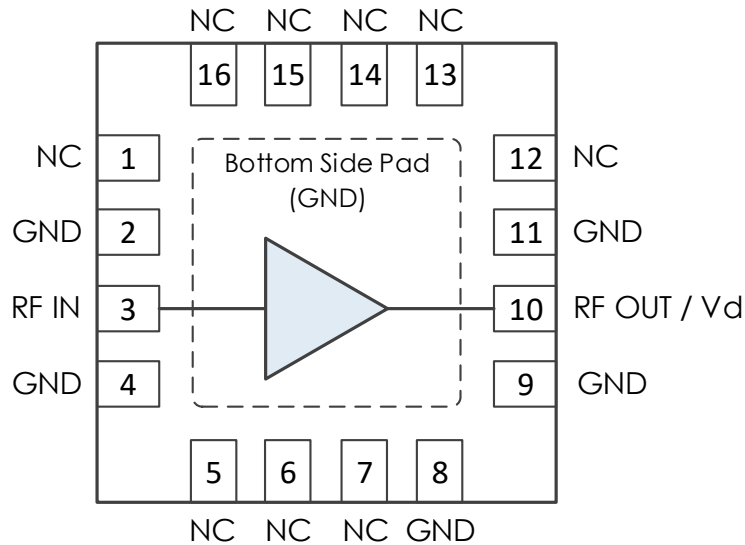

Pin Number	Pin Name	Pin Function
1	NC	Do Not Connect*
2	GND	Ground - Common
3	RF In	RF Input – 50 Ohms – DC Coupled. External DC Blocking Capacitor Required
4	GND	Ground - Common
5-7	NC	Do Not Connect*
8,9	GND	Ground - Common
10	RF Out / Vd	RF Output and DC Power Input – 50 Ohms – DC Coupled. External DC Blocking Capacitor Required
11	GND	Ground - Common
12-16	NC	Do Not Connect*
Case GND	GND	Ground - Common

*NC pins may be grounded or left open

AM1064-1 – Amplifier

DC to 8 GHz Gain Block

Pin Layout and Definitions (Continued)

Specifications

Absolute Maximum Ratings

	Minimum	Maximum
Supply Voltage	-0.3 V	+8.0 V
RF Input Power		+20 dBm
Operating Junction Temperature	-40 C	+150 C
Storage Temperature Range	-50 C	+150 C

Note: Any device operation beyond the Absolute Maximum Ratings may result in permanent damage to the device. The values listed in this table are extremes and do not imply functional operation of the device at these or any other conditions beyond what is listed under Recommended Operating Conditions. Any part subjected to conditions outside of what is recommended for an extended amount of time may suffer from reliability concerns.

Handling Information

	Minimum	Maximum
Storage Temperature Range (Recommended)	-50 C	+125 C
Moisture Sensitivity Level	MSL 3	



Atlanta Micro products are electrostatic sensitive. Follow safe handling practices to avoid damage

Recommended Operating Conditions

	Minimum	Typical	Maximum
Supply Voltage	+3.0 V		+5.2 V
Operating Case Temperature	-40 C		+85 C
Operating Junction Temperature	-40 C		+125 C

Thermal Information

	Thermal Resistance (°C / W)
Junction to Case Thermal Resistance (θ_{JC})	88

AM1064-1 – Amplifier

DC to 8 GHz Gain Block

DC Electrical Characteristics

(T = 25 °C unless otherwise specified)

Parameter	Testing Conditions	Minimum	Typical	Maximum
DC Supply Voltage		+3.3 V	+4.7 V	+5.0 V
DC Supply Current	Vd = 4.7 V		73 mA	
	Vd = 3.1 V		36 mA	
Power Dissipated	Vd = 4.7 V		0.34 W	
	Vd = 3.1 V		0.11 W	

RF Performance

(T = 25 °C unless otherwise specified)

Parameter	Testing Conditions	Minimum	Typical	Maximum
Frequency Range		DC		8 GHz
Gain	Vd = 4.7 V		21 dB	
Return Loss	Vd = 4.7 V		12 dB	
Output IP3			+32.0 dBm	
Output P1dB			+18.0 dBm	
Noise Figure			2.0 dB	

AM1064-1 – Amplifier

DC to 8 GHz Gain Block

Typical Performance

(Vd = +4.7 V, Id = 73 mA)

Gain vs Temperature

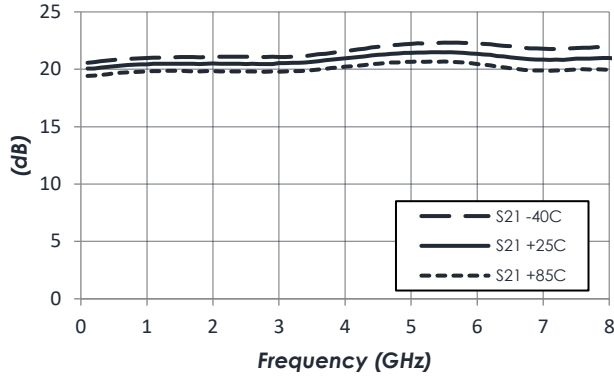

Noise Figure vs Temperature

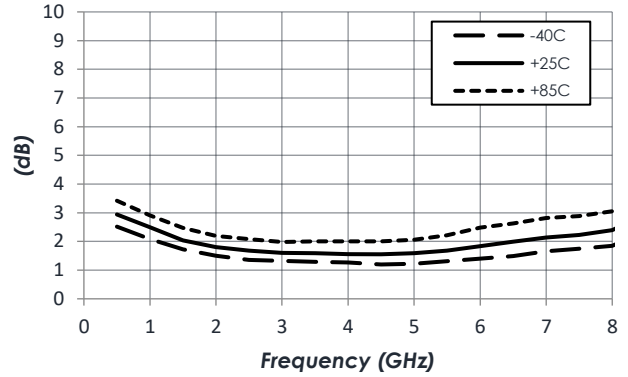

Output IP3 vs Temperature

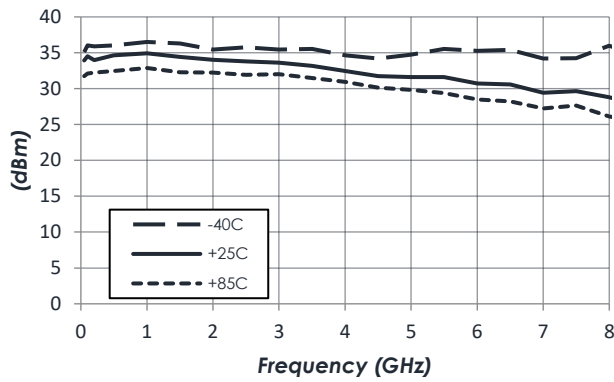

P1dB vs Temperature

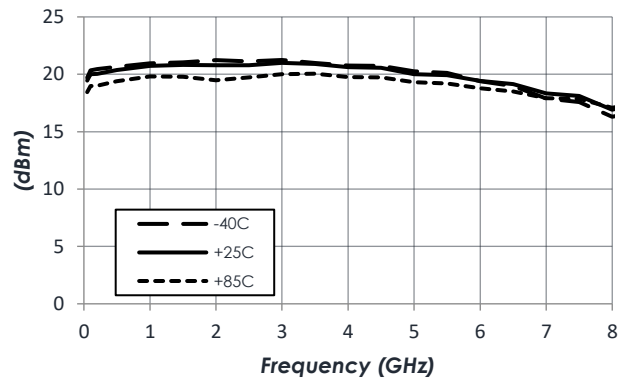

Reverse Isolation vs Temperature

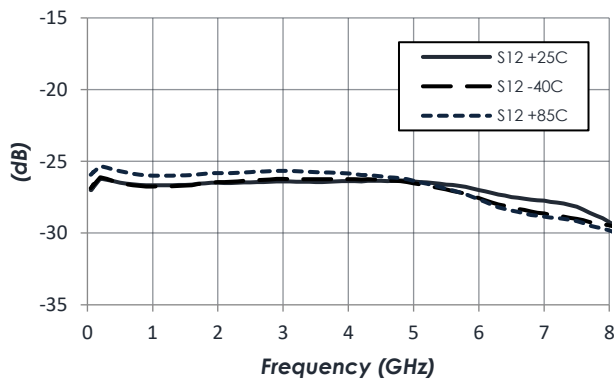

AM1064-1 – Amplifier

DC to 8 GHz Gain Block

Typical Performance (continued)

(Vd = +3.1 V, Id = 36 mA)

Gain vs Temperature

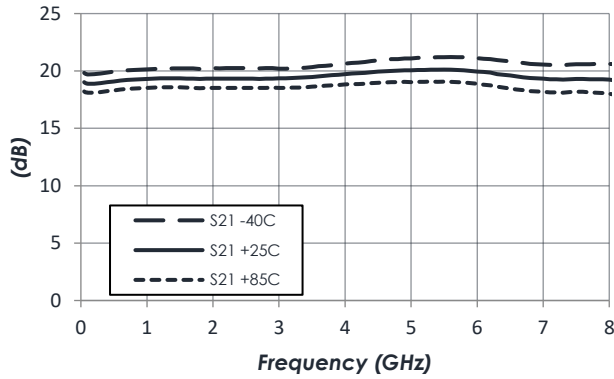

Noise Figure vs Temperature

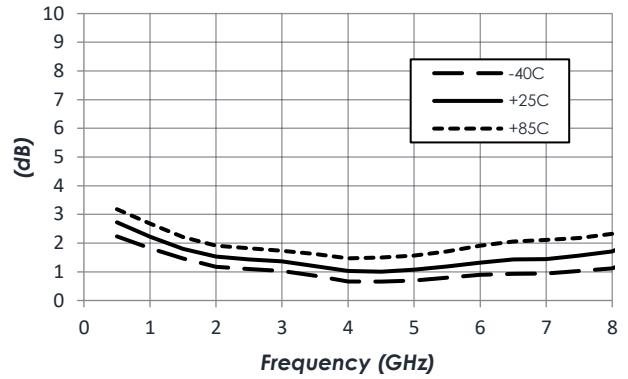

Output IP3 vs Temperature

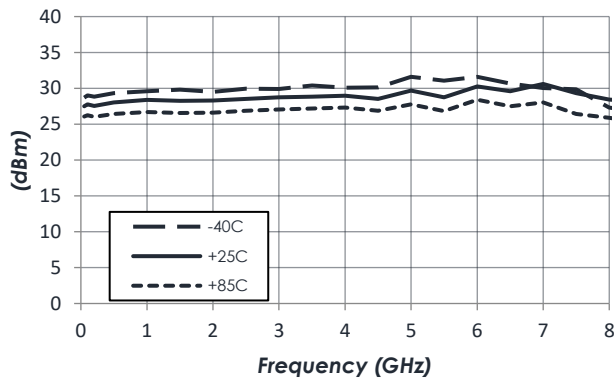

P1dB vs Temperature

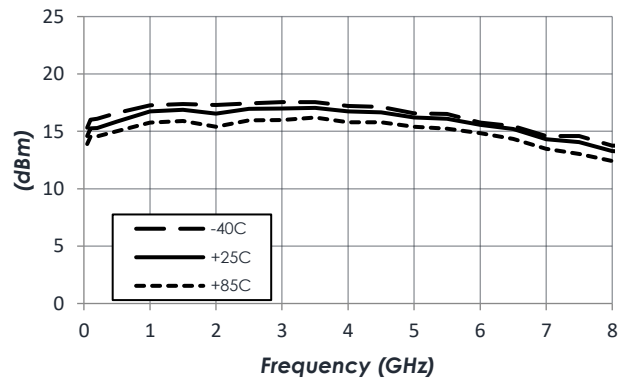

Reverse Isolation vs Temperature

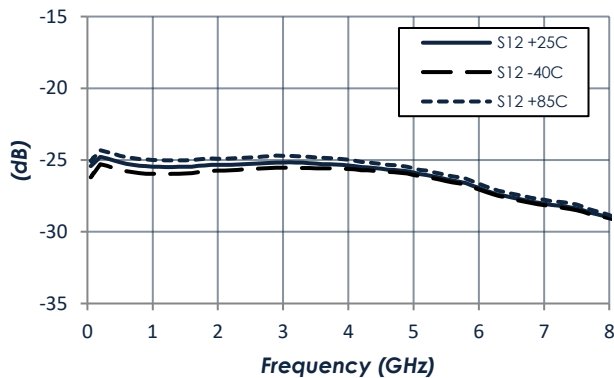

AM1064-1 – Amplifier

DC to 8 GHz Gain Block

Typical Performance (continued)

(T = 25 °C unless otherwise specified)

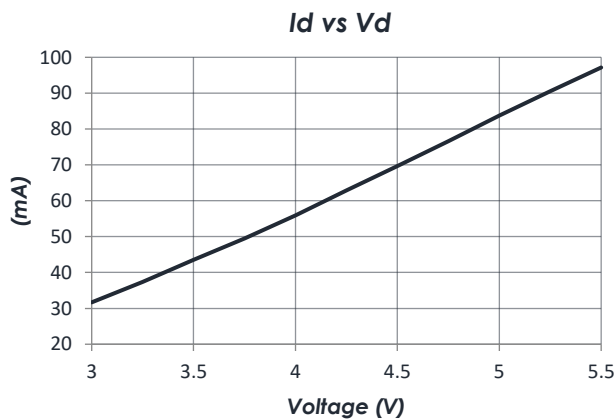
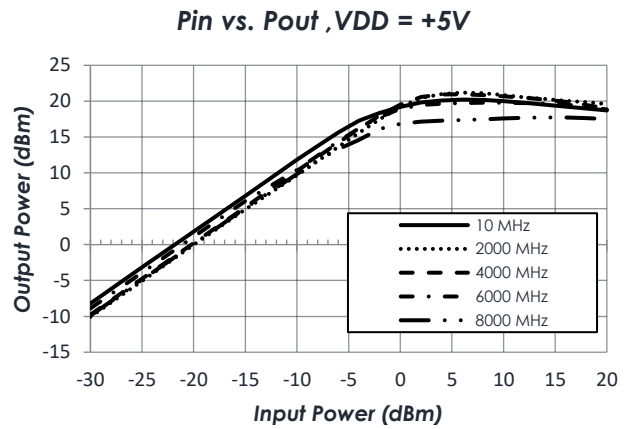
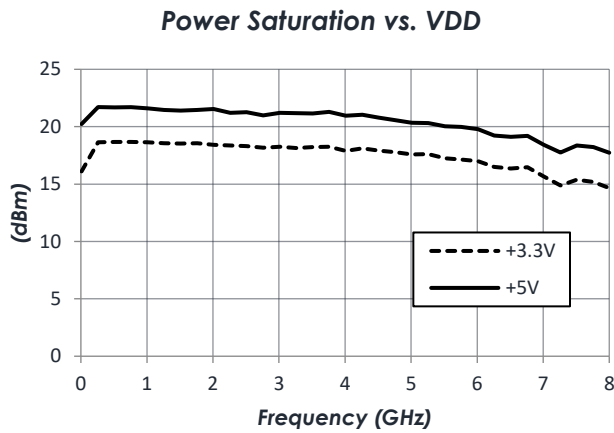
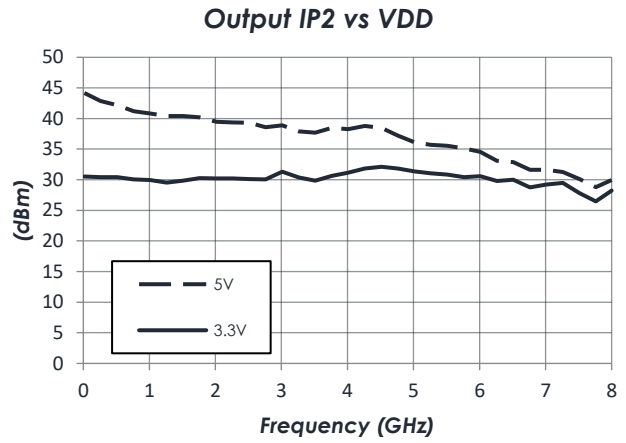
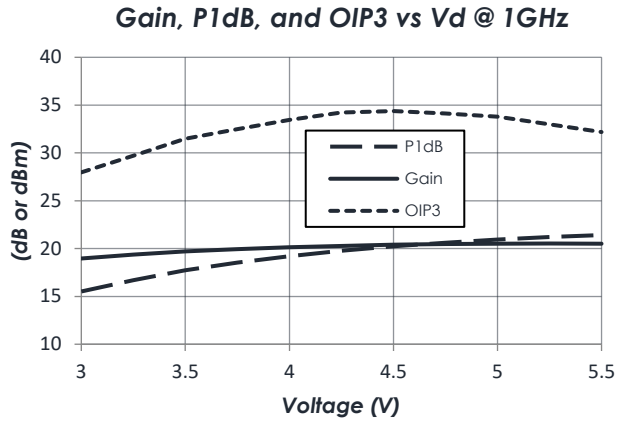

AM1064-1 – Amplifier

DC to 8 GHz Gain Block

Typical Application

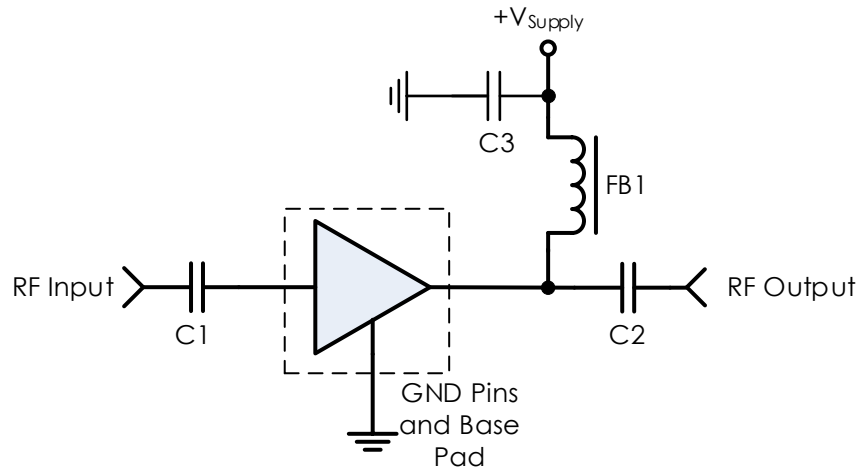

Recommended Component List (or equivalent):

Part	Value	Part Number	Manufacturer
C1, C2	0.1 μ F	0402BB104KW160	Passives Plus
C3	0.1 μ F	GRM155R71C104KA88	Murata
FB1	-	MMZ1005A222E	TDK

Notes:

1. NC pins may be grounded or left open
2. RF blocking capacitors should be high performance, low-loss, broadband capacitors for optimum performance

AM1064-1 – Amplifier

DC to 8 GHz Gain Block

Part Ordering Details

Description	Part Number
3mm 16 Lead QFN	AM1064-1
1.3mm x 2mm 6 Lead DFN (separate datasheet)	AM1064-2
AM1064-1 Evaluation Board	AM1064-1 Eval
AM1064-2 Evaluation Board	AM1064-2 Eval
AM1064-1 in 0.95" x 1.13" x 0.6" RF-Shielded Module with Integrated Bias Tee and Field Replaceable SMA Connectors	AM1064-M

Related Parts

Part Number	Description
AM1064-2	DC to 8 GHz Miniature Gain Block
AM1016B	20 MHz to 6 GHz +3.3V Gain Block
AM1018C	20 MHz to 6 GHz +5.0V Gain Block
AM1025B	20 MHz to 3 GHz +8.0V Gain Block (High P1dB)
AM1031C	20 MHz to 8 GHz +3.3V Gain Block
AM1063-1	DC to 10 GHz Gain Block
AM1063-2	DC to 10 GHz Miniature Gain Block
AM1065	DC to 8 GHz Bypassable Gain Block
AM1073	DC to 8 GHz Bidirectional / Bypassable Gain Block

Evaluation PC Board

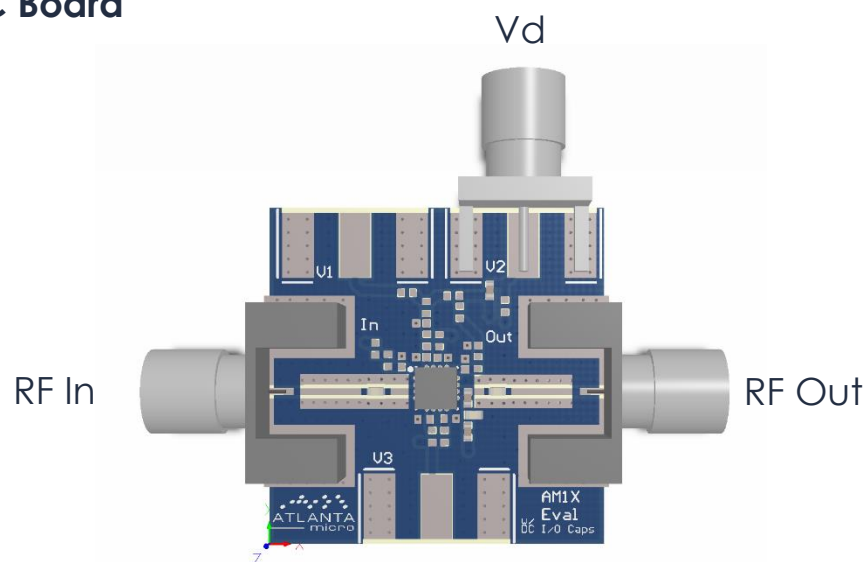

Component Compliance Information

RoHS: Atlanta Micro, Inc. hereby certifies that all products comply with the EC Directive 2011/65/EC on the Restriction of Hazardous Substances, commonly known as EU-RoHS 6 and 10. All products supplied by Atlanta Micro shall be compliant with the European Directive 2011/65/EC based on the following substance list.

Substance List	Allowable Maximum Concentration
Lead (Pb)	<1000 PPM (0.1% by weight)
Mercury (Hg)	<1000 PPM (0.1% by weight)
Cadmium (Cd)	<75 PPM (0.0075% by weight)
Hexavalent Chromium (CrVI)	<1000 PPM (0.1% by weight)
Polybrominated Biphenyls (PBB)	<1000 PPM (0.1% by weight)
Polybrominated Diphenyl ethers (PBDE)	<1000 PPM (0.1% by weight)
Decabromodiphenyl Deca BDE	<1000 PPM (0.1% by weight)
Bis (2-ethylhexyl) Phthalate (DEHP)	<1000 PPM (0.1% by weight)
Butyl Benzyl Phthalate (BBP)	<1000 PPM (0.1% by weight)
Dibutyl Phthalate (DBP)	<1000 PPM (0.1% by weight)
Diisobutyl Phthalate (DIBP)	<1000 PPM (0.1% by weight)

REACH: Atlanta Micro, Inc. neither uses nor intentionally adds any of the substances considered to be a Substance of Very High Concern (SVHC) as defined by the EU Regulation (EC) No. 1907-2006 on Registration, Evaluation, Authorization, and Restriction of Chemicals (REACH).

Conflict Materials: Atlanta Micro does not knowingly use materials that are sourced from the Democratic Republic of Congo (DRC) or any other known conflict regions. Atlanta Micro's supply chain is comprised of sources that are both environmentally and socially responsible. We periodically review this requirement with our vendors to ensure continued compliance.

Atlanta Micro takes its responsibility as a global partner seriously and will use due diligence within our supply chain to ensure all standards are met to the best of our knowledge.