



pi-top



# GETTING STARTED

— BE INSPIRED



# CONTENTS

**04** Getting started

**06** **pi-top**'s Journey

**08** What's in the box?

**10** Building Instructions

**18** Inventor's Kit

**20** **pi-top**OS Overview

**22** **pi-top**DASHBOARD

**24** **pi-top**CODER

**26** CEED**universe**

**30** Additional Apps

**34** Accessories

**35** FAQ & Troubleshooting

## > Discover a new universe

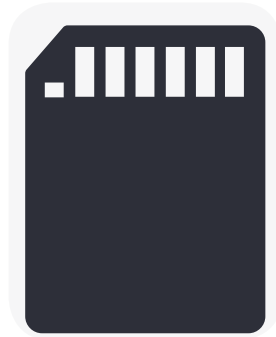

Remove your micro SD card

# > Hello world\_

Welcome to the exciting world of coding and electronics; this is where your journey as an inventor starts. We'll start by building your very own laptop, which you can use to build circuits and code all sorts of awesome inventions.

Use **pi-topCODER** to create exciting creations such as a smart robot or musical instrument, or to explore the alien world of **CEEDuniverse**.

The "Getting started" booklet is the first step to discovering this new universe, so let's get started!

# pi-top's Journey

---

pi-top is an invention as well; here is the invention process.



## Concept Drawing

Every great invention starts with a drawing on what it will do. When you invent, sometimes drawing will help you too.

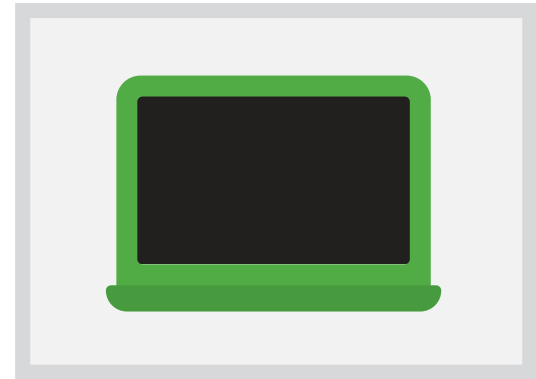

## Prototyping

We worked hard on building a prototype to see if our idea would actually work. Sometimes it won't, at first, but that's ok; you have to keep trying until it does!



## Testing

It's important to test and make sure that your invention works the way you want it to.

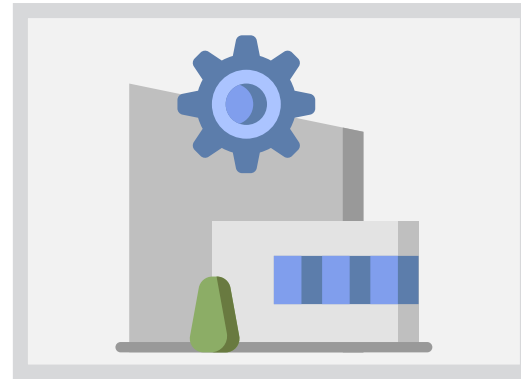

## Manufacturing

Once we've produced it, you are ready to start building this **pi-top**. Using this **pi-top** you can make your own inventions and share them with your friends.

# What's in the box

---



## pi-top

---

**pi-top** is a new type of laptop made for young inventors. The keyboard slides out to reveal a built-in workspace, where you can create your own projects!

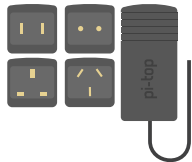

## Power Adapter & 4x Plug Heads

---

This takes mains power, which is high voltage, and reduces it down to make it usable for the **pi-top**. The different plug heads let you use your **pi-top** in different countries.

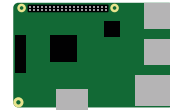

## Raspberry Pi 3

---

This is the brain of your **pi-top**. It allows you to code and build your projects, watch videos, browse the web and much more. Usually, it is sold separately.



## pi-top Multi-tool

---

It is both an SD card removal tool and a screwdriver for your **pi-top** internals. Very Handy!



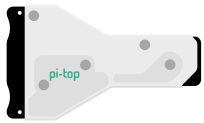

### Cooling Bridge

When the **pi-top** starts to work very hard, it produces heat and this heatsink cools it down. This also allows your projects to 'talk' with **pi-top's** brain so that you can build your own electronics using the Raspberry Pi and **pi-top** products seamlessly.



### SD Card with pi-topOS

This is where the whole operating system lives. Your **pi-top** needs it to know what to display on the screen.

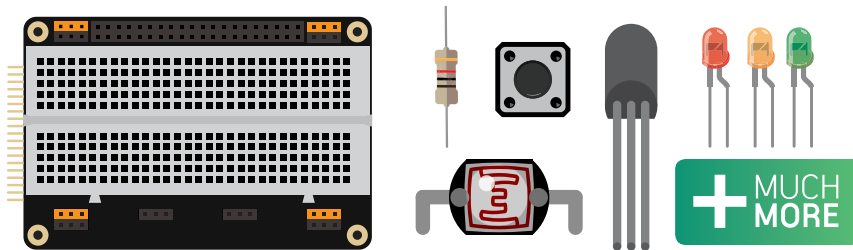

### Inventor's Kit

This kit has all the tools you need to make and invent awesome projects!

# Building Instructions

## Step 1.

Open the lid. Slide down the keyboard using the two thumb grooves at the top near both corners.

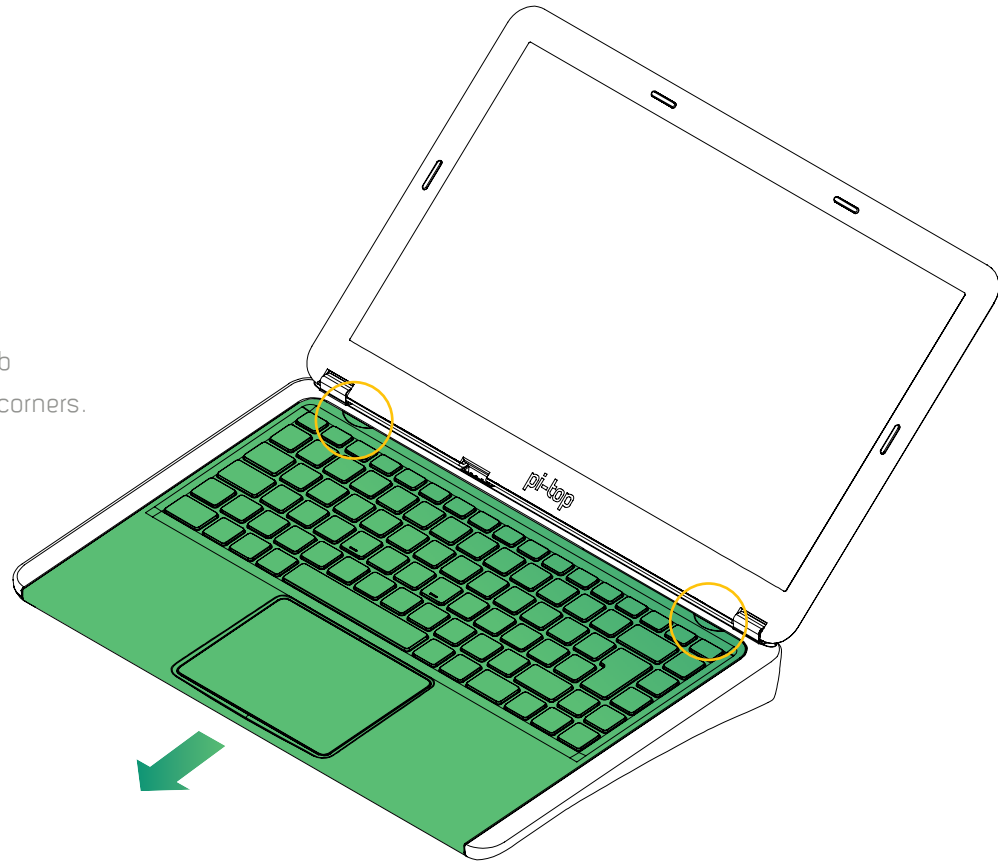

## Step 2.

Remove the Cooling Bridge on top of the micro-computer (Raspberry Pi). Use the multi-tool and lift off the Cooling Bridge carefully.

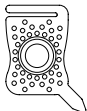
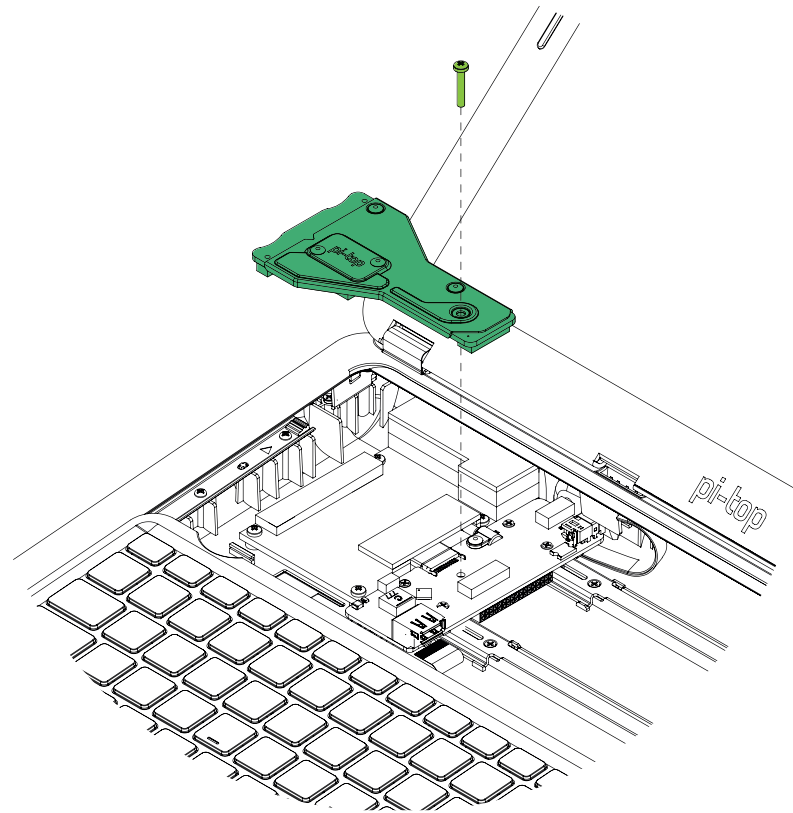

You'll need the **pi-top** Multi-tool for this. You'll find it in the chassis below the Cooling Bridge.

### Step 3.

Carefully slide the hub PCB, as shown in green, all the way to the right. Don't push it too hard or too far!

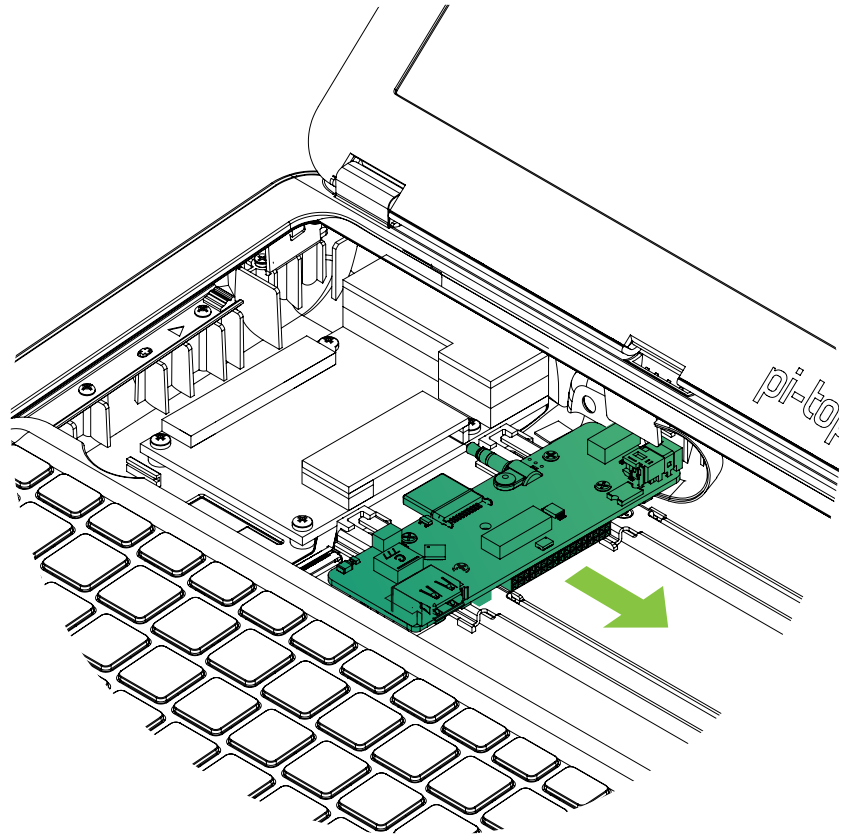

#### Step 4.

Unscrew the four Raspberry Pi screws from the Raspberry Pi placeholder (made from paper card). Slide the insert towards you and the top edge of the keyboard, as you lift it out.

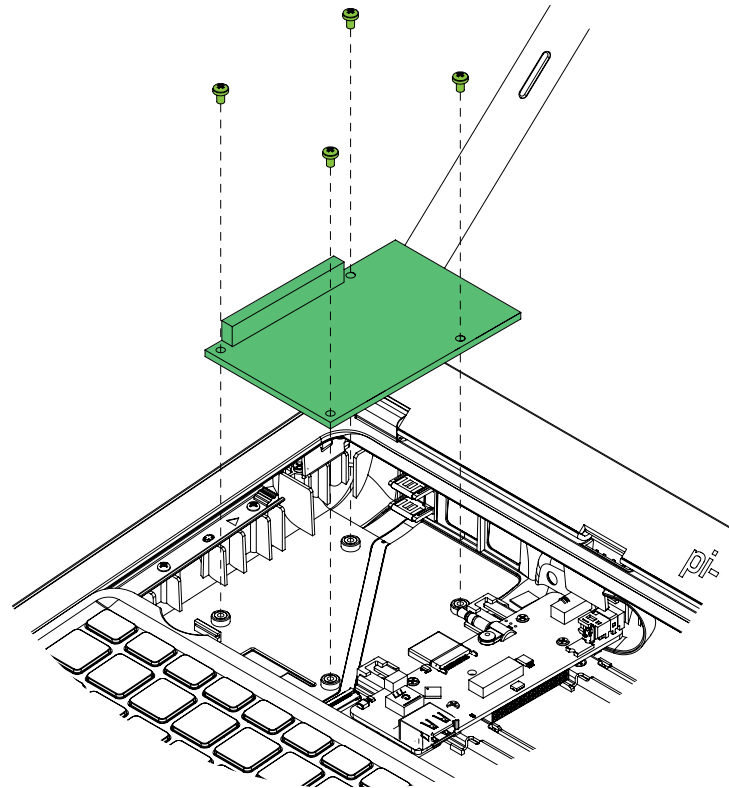

### Step 5.

i. Now remove the Micro SD card from the SD card adapter as shown.

ii. Insert the micro SD card into your Raspberry Pi as shown with the correct orientation. It should easily slide in; don't use too much force.

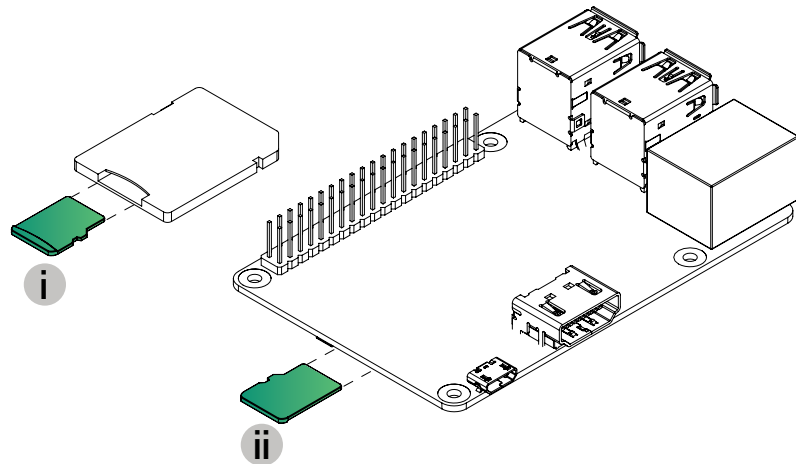

**Step 6.**

Carefully slide the left-hand USB ports into the USB Flexi-plug at the rear of the laptop.

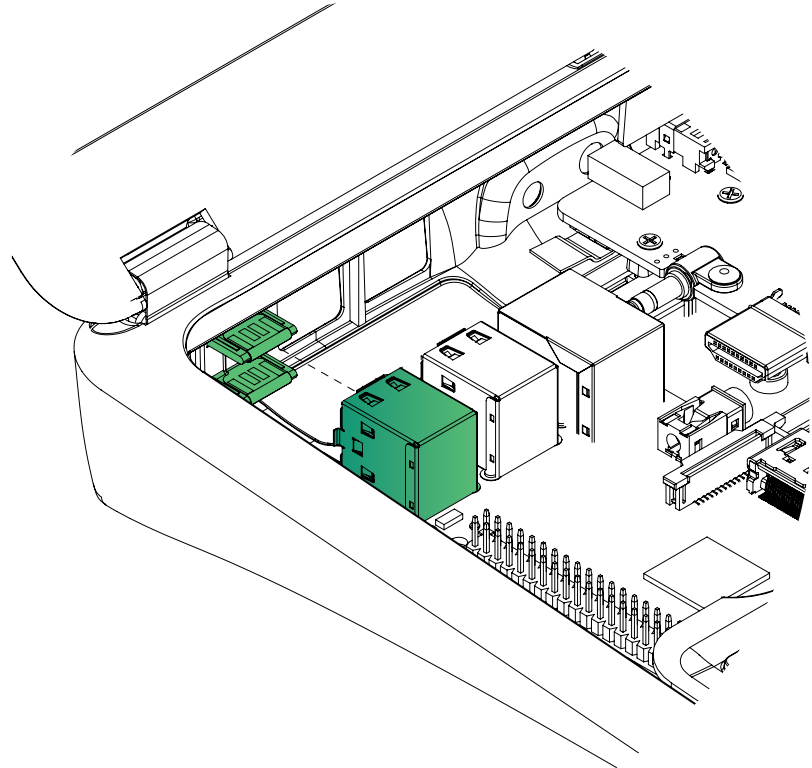

### Step 7.

Now using the multi-tool screw in the Raspberry Pi with the four screws from Step 4. Be careful to not over-tighten the screws.

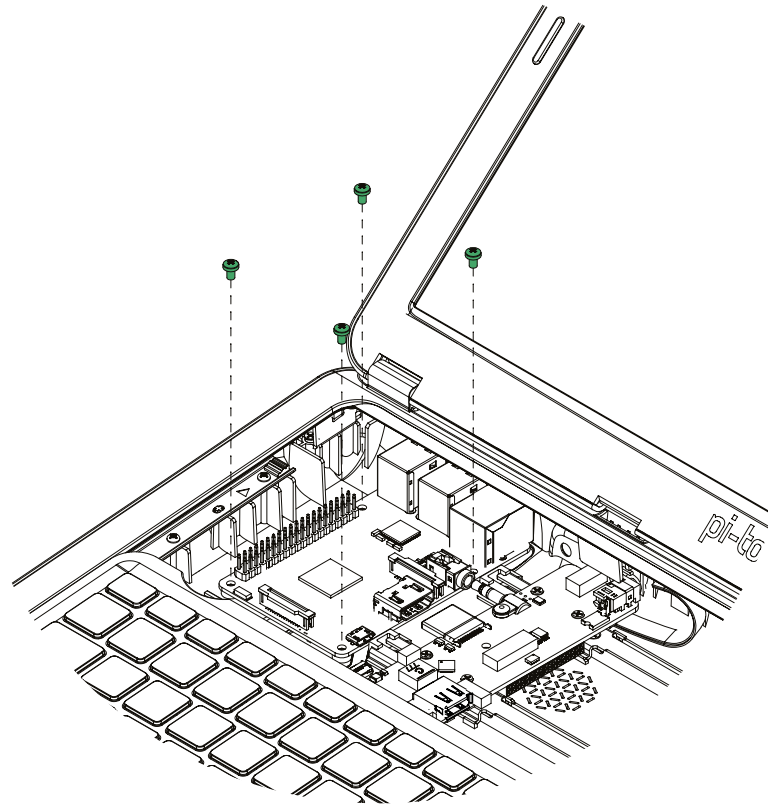



### Step 8.

Now carefully slide the hub to the left. Make sure to position the HDMI and audio jack in the associated ports on the Raspberry Pi.

If the hub doesn't align properly with the Raspberry Pi ports, simply turn the adjustment screws (highlighted in red) to raise or lower the HDMI connector. Turning clockwise will lower it, anti-clockwise will raise it.

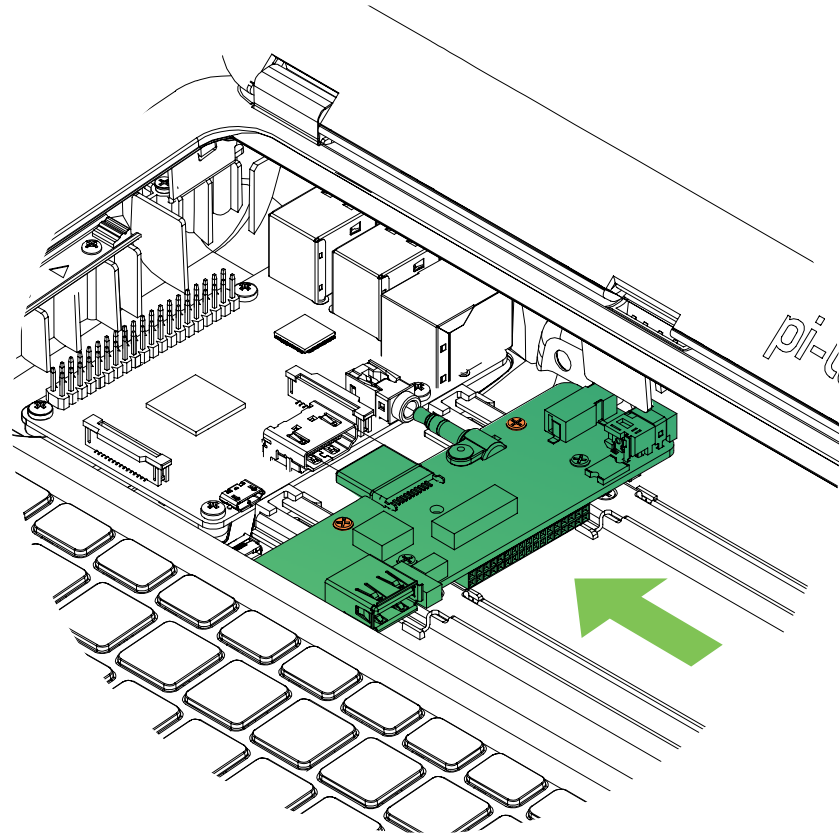

### Step 9.

Place the Cooling Bridge onto the Raspberry Pi GPIO pins, taking care to align correctly!

Push down gently on the right side of the Cooling Bridge to pop it into the **pi-top** hub. Use the multi-tool to tighten the Cooling Bridge in place with the screw removed in Step 2. Tighten it just enough so that the cooling bridge doesn't move or shake.

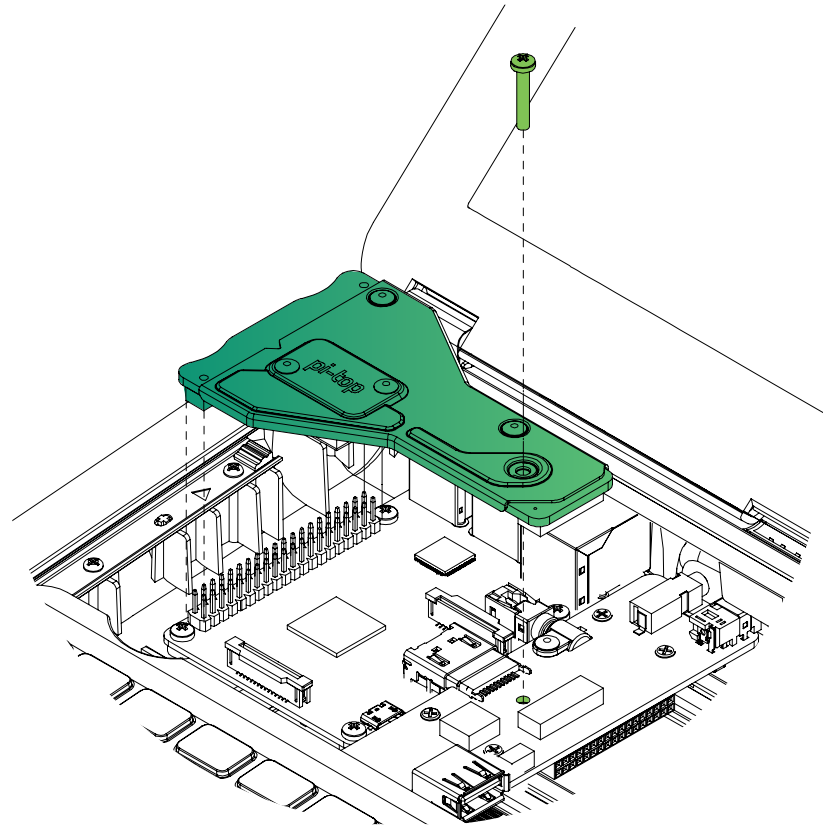

**Step 10.**

Slide up the keyboard into the closed position and you are all done building your **pi-top!**

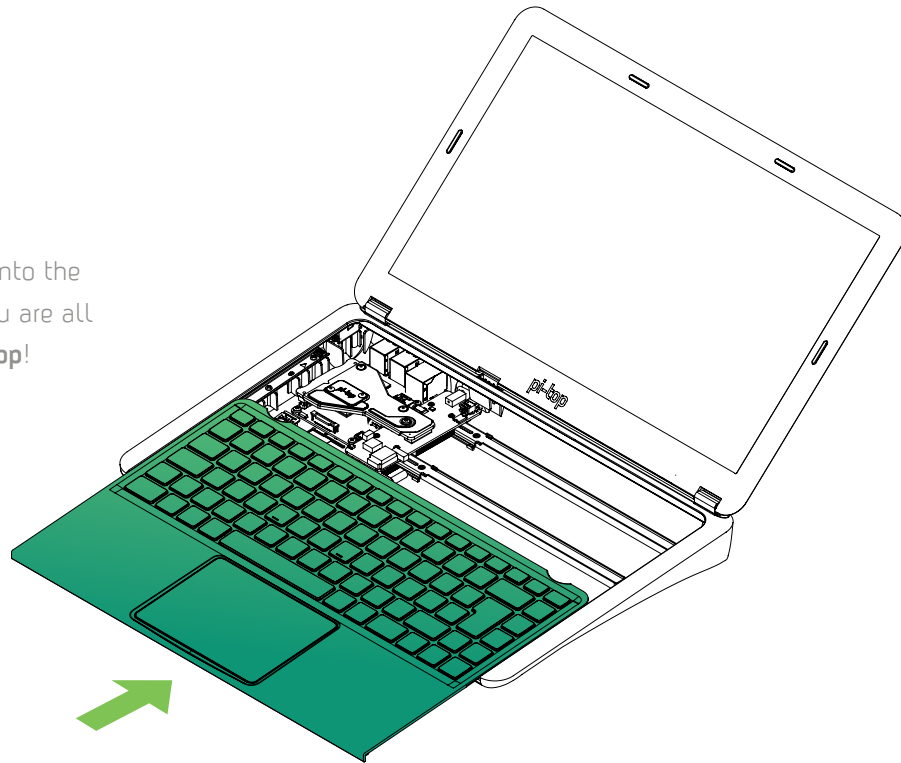

## Step 11.

You have just built your **pi-top**.  
Take a step back and admire your  
creation!

Well done, it is now time to start  
building your own inventions!



## Step 12.

To switch on your **pi-top** and start your journey as a creator, press the power button highlighted on the keyboard in the upper right hand corner.

A world of discovery awaits you!

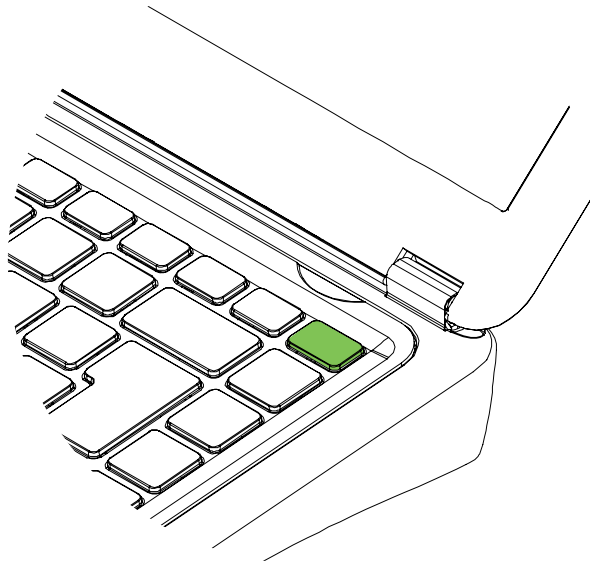

# Your First Invention

Now that you have built your **pi-top**, let's get to building your first creation!



## Boot up pi-topOS

Make sure the Raspberry Pi has the **pi-topOS** SD card inserted. Boot up the **pi-top** with the power button on the keyboard.

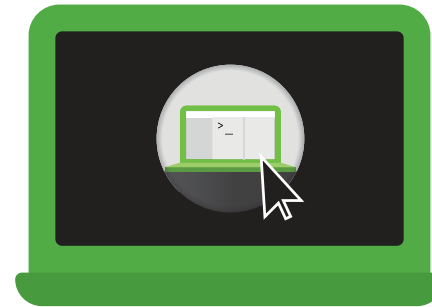

## Launch pi-topCODER & select "Let there be light!"

Launch **pi-topCODER** and search for "Let there be light", click on the project and **click LAUNCH to begin.**

```
>Led.on()
```

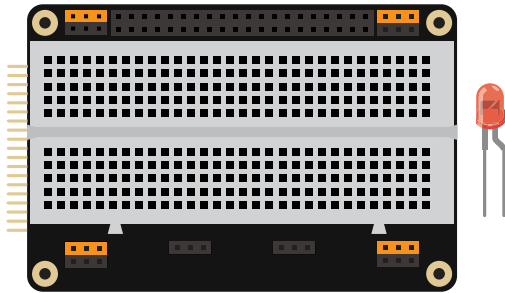

## Build circuit & code LED

Follow the step by step instructions in **pi-top**CODER to build and code your circuit.

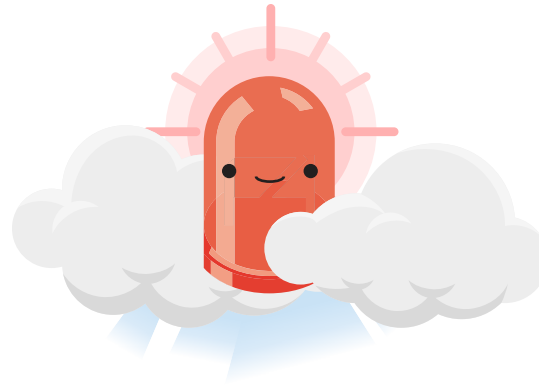

## Hooray! Your first creation!

Congratulations! You are well on your way to building and coding your first circuit. Check out the Inventor Guide for many more projects!

## Hardware Pro-tips

---

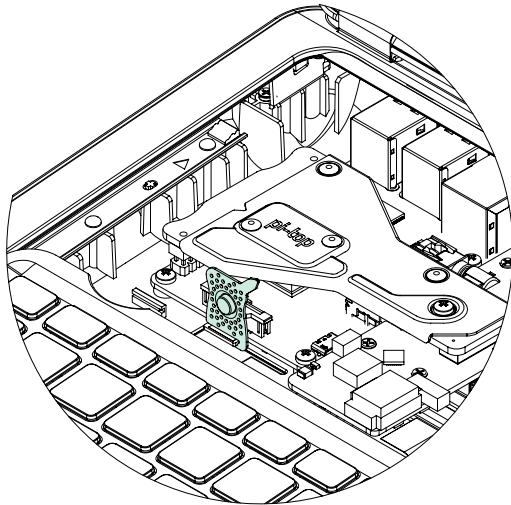

You can use the multi-tool provided to remove your SD card from the Raspberry Pi 3.

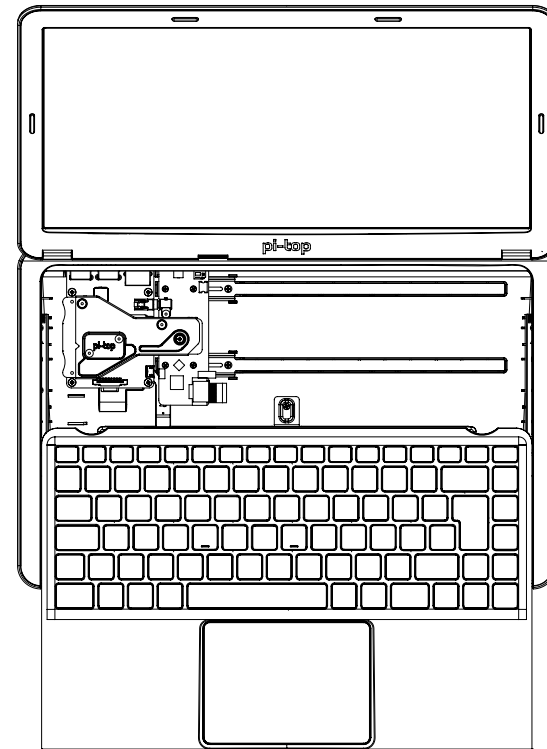

Slide the keyboard open to access the magnetic Modular Rail and the internal USB port.



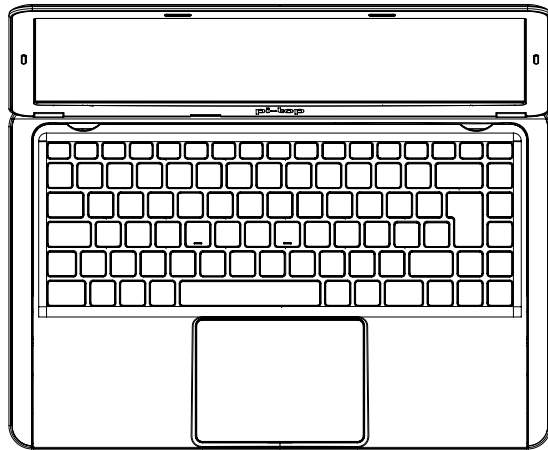

Keyboard closed

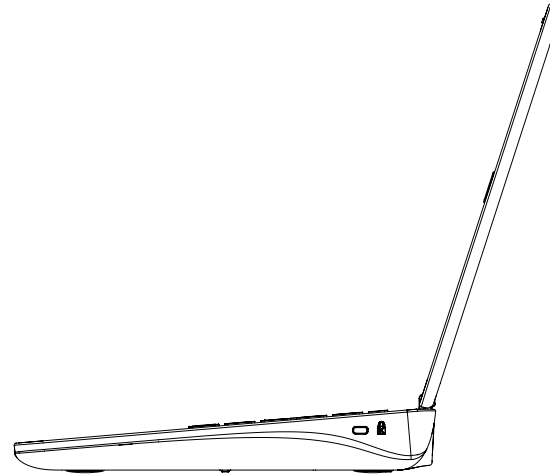

Kensington security slot

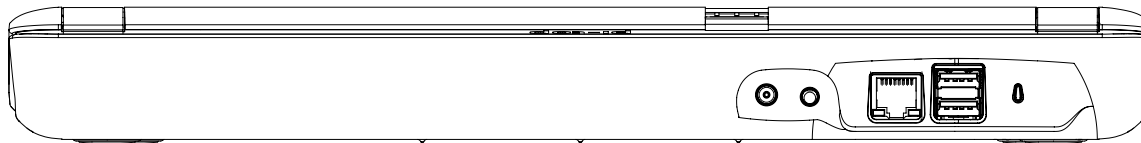

You can find (From left to right) the Power Adapter port, 3.5mm Audio Jack, Ethernet port, 2 USB ports, and a power on LED on the back of the device.

# pi-top Inventor's Kit

Every great piece of technology that we use today was invented by someone. Whether we're talking about the wheel or the smartphone, everyone had to start somewhere. Like Charles Babbage and Ada Lovelace inventing the first computer, the Inventor's Kit is your first step into becoming a digital maker and inventor.

## Famous Inventors



**Nikola Tesla**

Alternating Current Electricity



**Ada Lovelace**

First computing machine



**Elon Musk**

Tesla cars and SpaceX

# Inventor's Journeys



## Music Maker

Discover the world of electronic music by creating, remixing and inventing your own musical instruments. Use the inventor kit to alter and shift different sounds until you're ready to party.

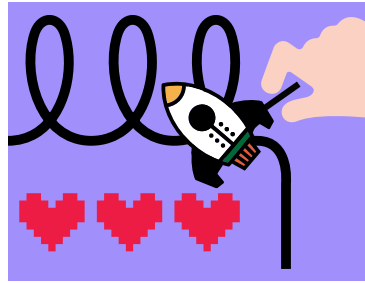

## Space Race

Make your own rules to the steady hand games with the inventor's kit. Add power-ups, lives, and nerve-racking sounds to beat your friends.

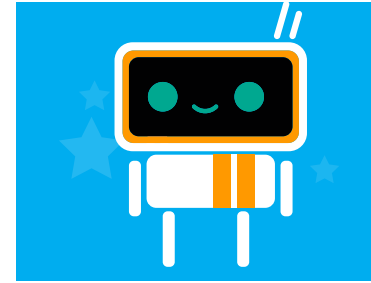

## Smart Robot

Design your own digital pet that lights up, beeps or makes sounds in response to noise, light or motion. You're in charge of how your robot responds to different inputs so be creative in your robot code to bring your pet to life.

# pi-topOS Overview

Now that your dashboard is up and running you can get to know the **pi-topOS** apps.

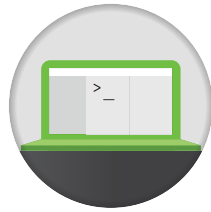

## pi-topCODER

Whether you're an expert or a beginner, **pi-topCODER** is an exciting and intuitive coding environment which allows you to explore the world of coding and physical computing at your own pace.

See page 32



## CEEDuniverse

Greetings explorers.  
Embark on an epic journey!  
After crash-landing on a strange new planet, you will explore alien worlds, discover hidden secrets, and advance your knowledge in science and technology along the way.

See page 34



Chromium



Google Drive



Libre Office



3D Slash



Python



Gmail



Docs



Slides



Mathematica



Scratch



Youtube



Minecraft



Sheets



Sonic Pi



CEEDuniverse

## More apps to explore

You can use your **pi-top** like any normal laptop, these are some of the amazing apps you have access to!

# Welcome

Welcome to the dashboard. This is your starting-point in **pi-topOS**. It simplifies the way you interact with the Raspberry Pi and will be the main hub for all your activities on your device.

This is also where you can access all other additional apps on **pi-topOS**.

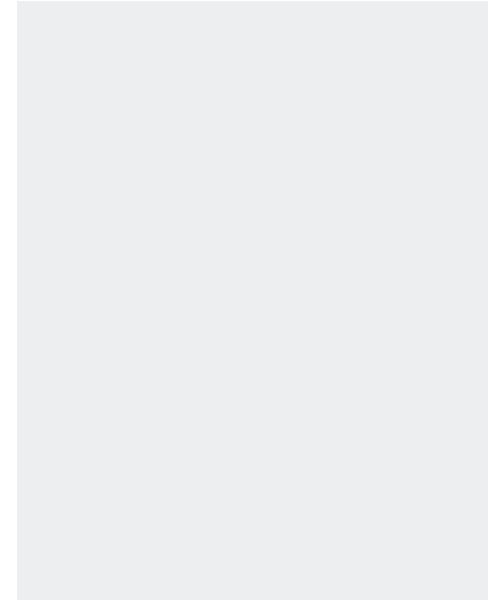

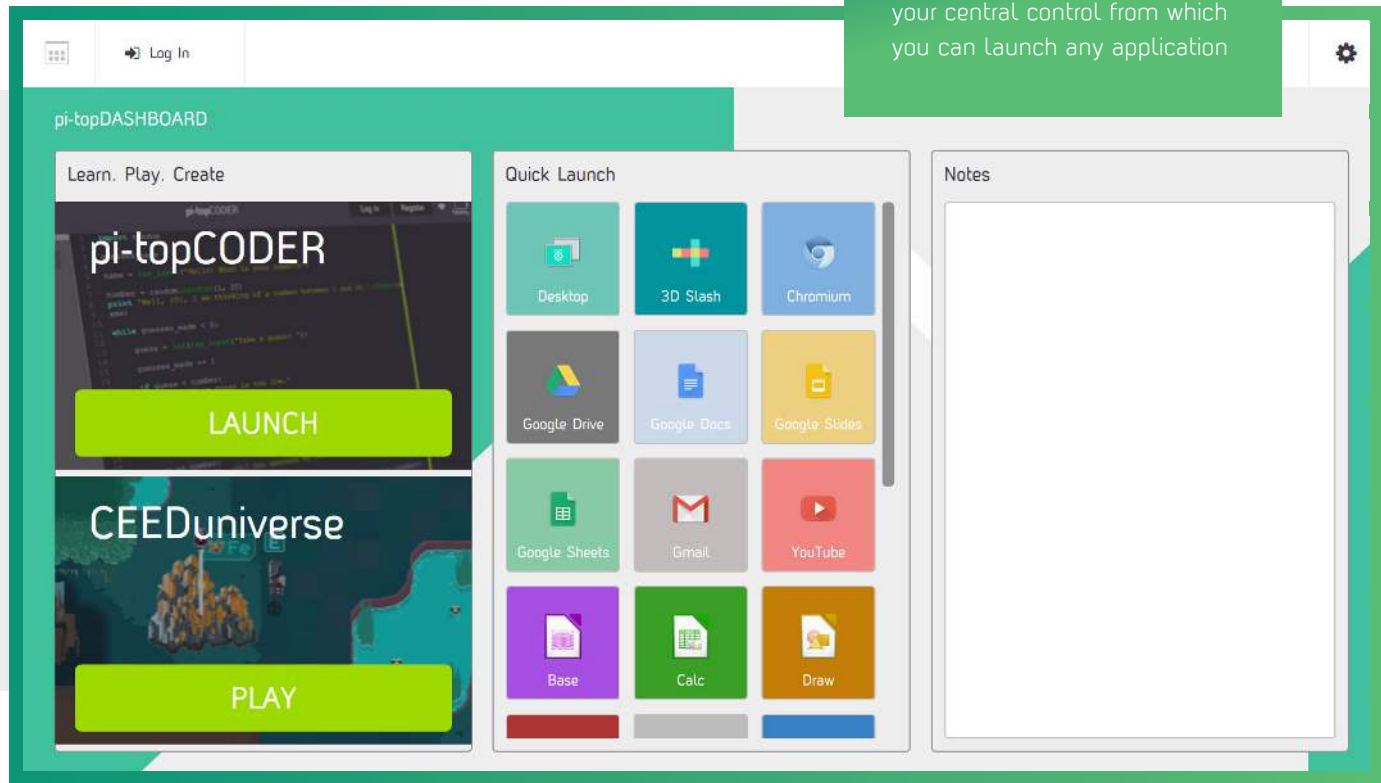

The pi-topDASHBOARD acts as your central control from which you can launch any application

## pi-topCODER

Access Raspberry Pi resources and projects created by educators from all over the world. You will learn the fundamentals of programming, physical computing and be able to track your progress along the way.

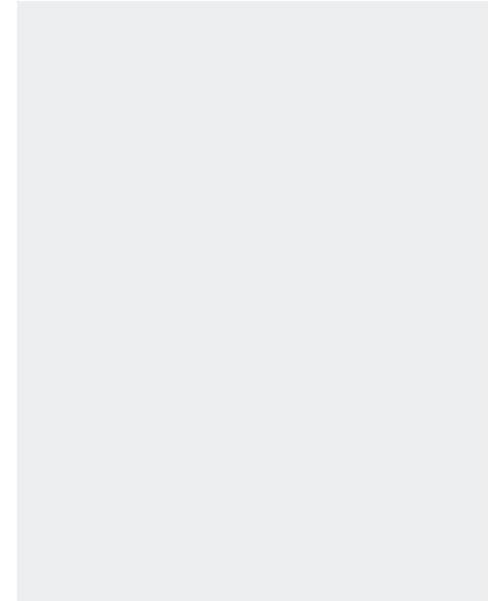



Log In

### Lighting an led

LEDs are delicate little things. If you put too much current through them they will pop (sometimes quite spectacularly). To limit the current going through the LED, you should always use a resistor in series with it.

Try connecting the long leg of an LED to the Pi's 3V3 and the short leg to a GND pin. The resistor can be anything over about 50Ω.

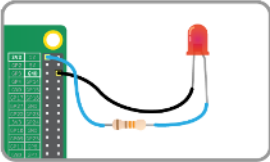

The LED should light up. It will always be on, because it's connected to a 3V3 pin, which is itself always on.

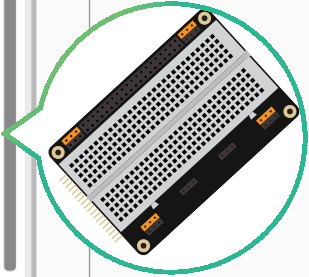

1

Submit Run Stop

Font Python 3 Font Clear

pi-topCODER has a fully integrated coding environment which allows you to program hardware, code in Python and learn lots of STEAM skills so that you learn and understand the key computing concepts.

## CEEDuniverse

Explore the alien world of CEEDuniverse and learn to code Python along your journey.

For the best experience, you may want to use a **pi-top**SPEAKER.



### HARDWARE INTEGRATION

You can also build circuits to interact with CEEDuniverse. For example; build a button to turn on the flashlight to illuminate dark caves.



## MINIGAMES

Learn programming concepts through fun minigames, such as cracking locks with code and piloting nanobots through circuits.

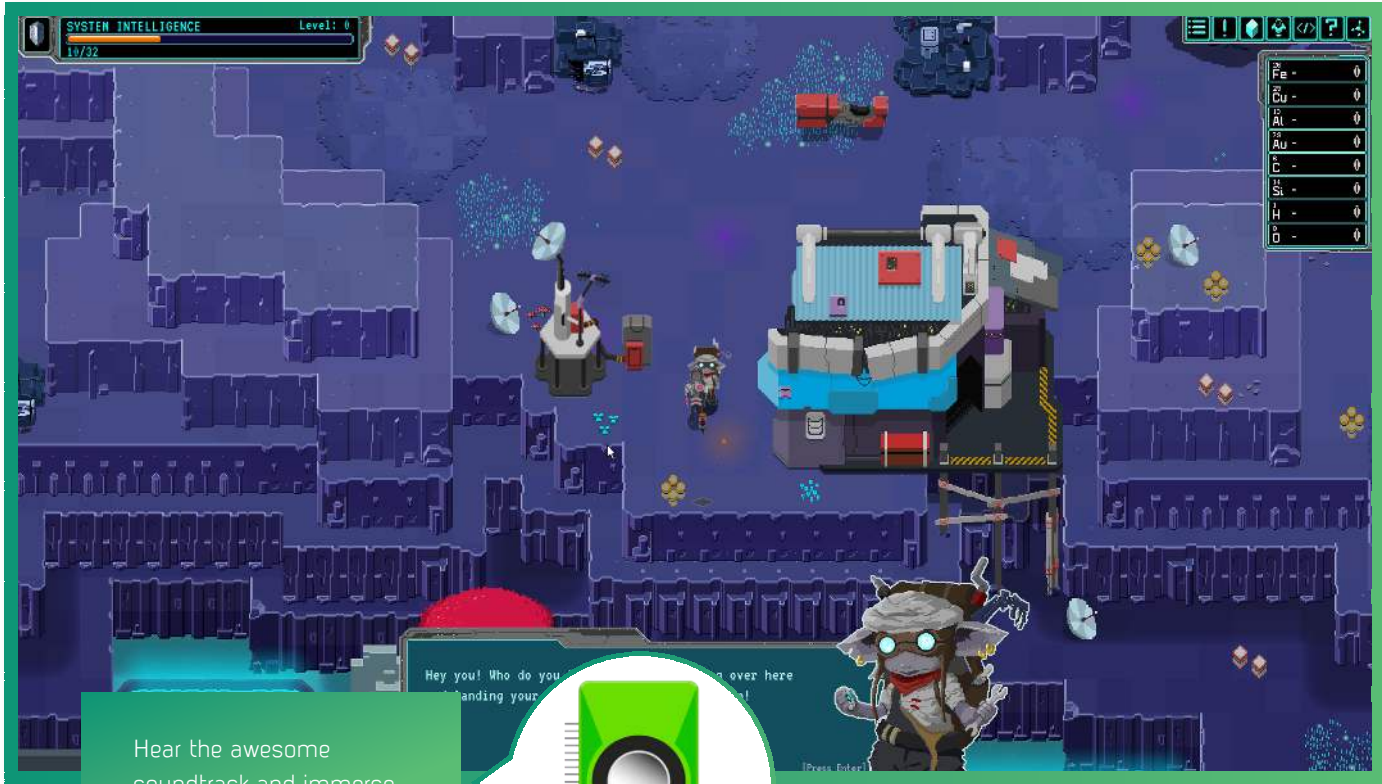

Hear the awesome  
soundtrack and immerse  
yourself in CEEDuniverse.



Meet fun & interesting  
characters through your  
journey!



PEAT



OSWALD



SUSIE

# Minecraft

pi-topOS comes with a special version of Minecraft, allowing you to interact with the world using text commands, which lets you build things in the game automatically using Python.

```
import time
import mcpi.minecraft as minecraft
mc = minecraft.Minecraft.create()

while True:
    mc.postToChat("Hi from PITOP ")
```

In this example, a simple Python script sends a message to the Minecraft chat window and displays it until someone stops the script.



# Sonic Pi

Explore a world of sound! Sonic Pi allows you to create, compose or perform music through code in an incredible range of styles.

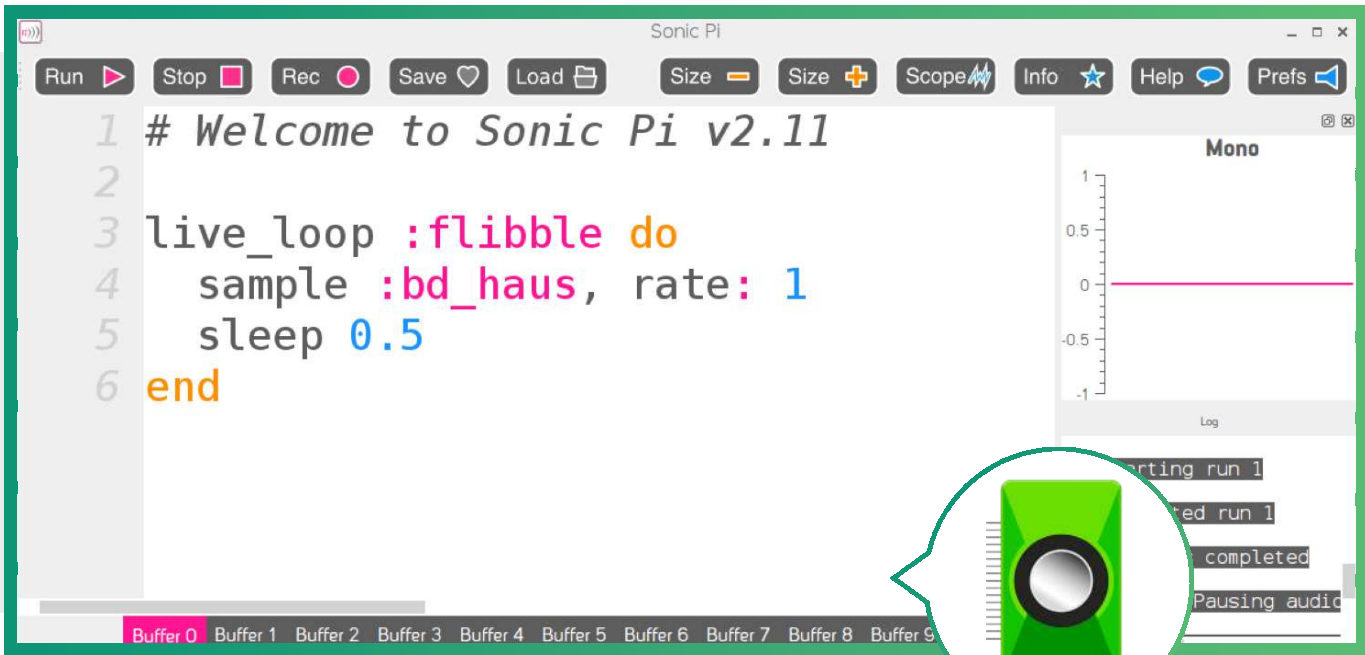

The image shows a screenshot of the Sonic Pi application window. The title bar reads "Sonic Pi". The interface includes a toolbar with buttons for Run, Stop, Rec, Save, Load, Size (minus and plus), Scope, Info, Help, and Prefs. The main code editor contains the following code:

```
1 # Welcome to Sonic Pi v2.11
2
3 live_loop :flibble do
4   sample :bd_haus, rate: 1
5   sleep 0.5
6 end
```

On the right side, there is a "Mono" waveform display with a vertical axis ranging from -1 to 1. Below the waveform is a "Log" window showing the following text:

```
Starting run 1
Completed run 1
Completed
Pausing audio
```

At the bottom of the window, there is a "Buffer" bar with labels for Buffer 0 through Buffer 9. A green circular callout with a speaker icon is overlaid on the bottom right of the interface.

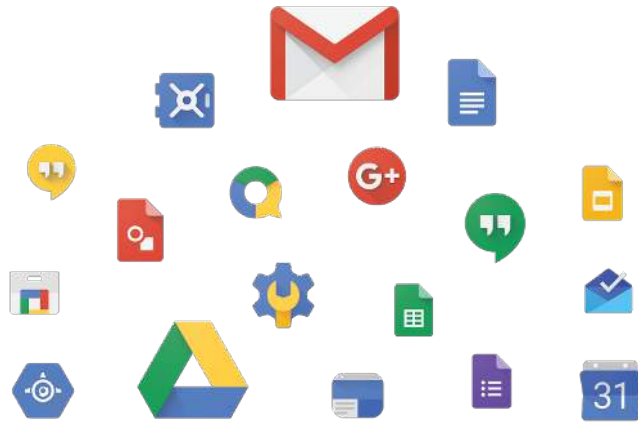

## G Suite

pi-topOS provides you with full access to G Suite - everything you need to do your best work seamlessly across your devices.





## Libre Office

Fully compatible with  
Microsoft Office, macOS  
and Google Drive.

Visit [www.pi-top.com](http://www.pi-top.com) to see our full range of amazing accessories!

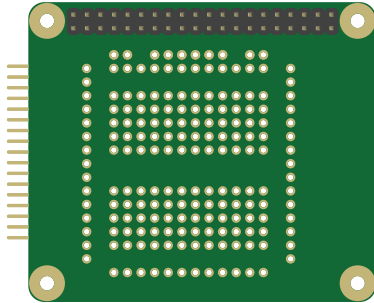

### pi-topPROTO

Use **pi-topPROTO** to make circuits for **pi-topCODER** and **CEEDuniverse** & even solder your own projects.

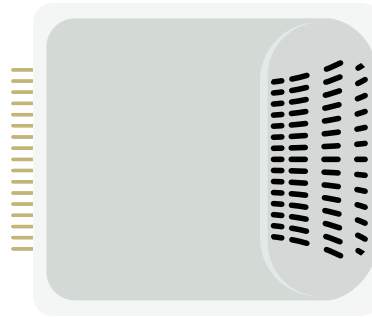

### pi-topPULSE

**pi-topPULSE** brings the arts into STEAM. Code your own games, create music and light shows and build your own **pi-top** powered Amazon Alexa!



### pi-topSPEAKER

Use **pi-topSPEAKER** to give your **pi-top** a voice. Enjoy immersive gameplay in **CEEDuniverse** or making your own music in Sonic Pi.

# FAQ & Troubleshooting

**My pi-top doesn't turn on**

Make sure that the Cooling Bridge is firmly secured on all of the pins. If this is not done properly, power will not be able to flow from the hub to the Raspberry Pi.

**Cooling Bridge doesn't connect properly**

You can alter the height of the hub using the screws. If the cooling mechanism doesn't slot on nicely, try adjusting the height of the hub.

**Keyboard and Trackpad don't work**

Make sure that the USB plug in the **pi-top** is properly inserted into the Raspberry Pi as this is what communicates with the Keyboard and Trackpad.

**My pi-top won't show anything on the screen**

Make sure that the microSD card has been securely slotted into the Raspberry Pi before powering on your **pi-top**.

**Still stuck?**

Please don't hesitate to email us at [support@pi-top.com](mailto:support@pi-top.com)  
Send us a tweet to [@GetPitop](https://twitter.com/GetPitop) or visit us at [pi-top.com/support](https://pi-top.com/support)



## Notes

---

---

---

---

---

---

---

---

---

---



## Notes

---

---

---

---

---

---

---

---

---

---

# BE INSPIRED



---

pi-top  
Model: 2.0  
Brand: pi-top  
Manufacturer Name: CEED LTD  
Manufacturer Address:  
**London, UK**

---

This device complies with Part 15 of the FCC Rules.  
Operation is subject to the following two conditions:

1. This device may not cause harmful interference.
2. This device must accept any interference received, including interference that may cause undesired operation.

