



Positive Lock | Mark II, Positive Lock 250

TE Internal #: 1-520935-2

Crimp Terminal Housings, Receptacle, Receptacle, 2 Position, Straight, UL 94V-0, Red, Nylon, Contact Mating Retention, Positive Lock 250

[View on TE.com >](#)

Terminals & Splices > Terminal Housings, Insulation Sleeves & Blocks > Crimp Terminal Housings

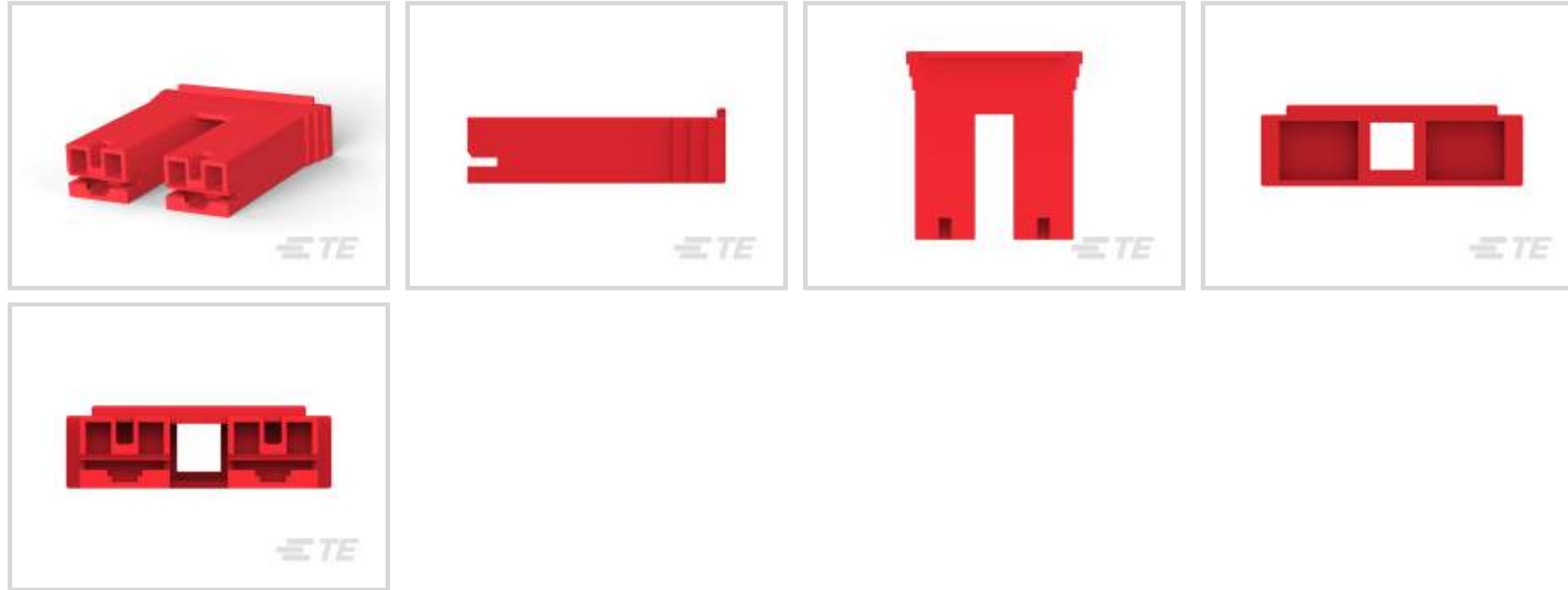

Terminal Type: **Receptacle**

Connector & Housing Type: **Receptacle**

Number of Positions: **2**

Terminal Orientation: **Straight**

UL Flammability Rating: **UL 94V-0**

Features

Product Type Features

Sealable	No
Connector System	Wire-to-Board, Wire-to-Wire
Connector & Contact Terminates To	Wire & Cable
Connector & Housing Type	Receptacle

Configuration Features

Number of Positions	2
---------------------	---

Body Features

Primary Product Color	Red
-----------------------	-----

Contact Features

Terminal Type	Receptacle
Terminal Orientation	Straight
Contact Mating Retention	With

Mechanical Attachment

--	--



Mating Alignment Type	Polarization
Mating Alignment	With
Connector Mounting Type	Cable Mount (Free-Hanging)

Housing Features

Housing Material	Nylon
Centerline (Pitch)	15.11 mm[.595 in]

Dimensions

	.475 in
--	---------

Usage Conditions

Operating Temperature Range	-40 – 105 °C[-40 – 221 °F]
-----------------------------	----------------------------

Industry Standards

UL Flammability Rating	UL 94V-0
------------------------	----------

Packaging Features

Packaging Quantity	1
Packaging Method	Carton

Product Compliance

[For compliance documentation, visit the product page on TE.com>](#)

EU RoHS Directive 2011/65/EU	Compliant
EU ELV Directive 2000/53/EC	Compliant
China RoHS 2 Directive MIIT Order No 32, 2016	No Restricted Materials Above Threshold
EU REACH Regulation (EC) No. 1907/2006	Current ECHA Candidate List: JUNE 2023 (235) Candidate List Declared Against: JUNE 2023 (235) Does not contain REACH SVHC
Halogen Content	Low Halogen - Br, Cl, F, I < 900 ppm per homogenous material. Also BFR/CFR/PVC Free
Solder Process Capability	Not applicable for solder process capability

Product Compliance Disclaimer

This information is provided based on reasonable inquiry of our suppliers and represents our current actual knowledge based on the information they provided. This information is subject to change. The part numbers that TE has identified as EU RoHS compliant have a maximum concentration of 0.1% by weight in homogenous materials for lead, hexavalent chromium, mercury, PBB, PBDE, DBP, BBP, DEHP, DIBP, and 0.01% for cadmium, or qualify for an exemption to these limits as defined in the Annexes of Directive 2011/65/EU (RoHS2). Finished electrical and electronic equipment products will be CE marked as required by Directive 2011/65/EU. Components may not be CE marked. Additionally, the part

numbers that TE has identified as EU ELV compliant have a maximum concentration of 0.1% by weight in homogenous materials for lead, hexavalent chromium, and mercury, and 0.01% for cadmium, or qualify for an exemption to these limits as defined in the Annexes of Directive 2000/53/EC (ELV). Regarding the REACH Regulation, the information TE provides on SVHC in articles for this part number is based on the latest European Chemicals Agency (ECHA) 'Guidance on requirements for substances in articles' posted at this URL: <https://echa.europa.eu/guidance-documents/guidance-on-reach>

Compatible Parts



TE Part # 63933-2
250 PL MKIII REC. 22-18AWG TPBR



TE Part # 63854-1
250 PL MKIII REC. 18-14AWG BR



TE Part # 63854-2
250 PL MKIII REC. 18-14AWG TPBR



TE Part # 63933-1
PL .250 TERMINAL REC 22-18 AWG BR



TE Part # 1217092-1
PL 250 TERMINAL RECEPTACLE 16-12 AWG BR



TE Part # 1217092-2
PL 250 TERMINAL REC 16-12 AWG TPBR



TE Part # 1-521119-1
POSILOCK HSG, .250 SRS, MKIII, 2P, V0, NAT

Also in the Series | Mark II



Automotive Housings(7)

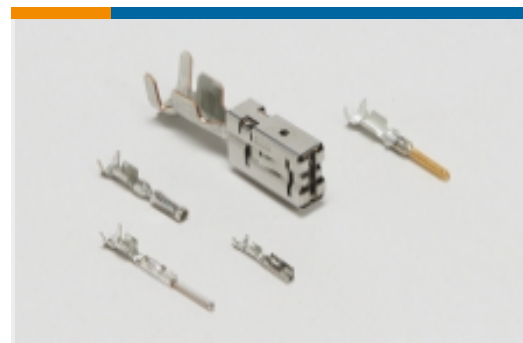

Automotive Terminals(22)

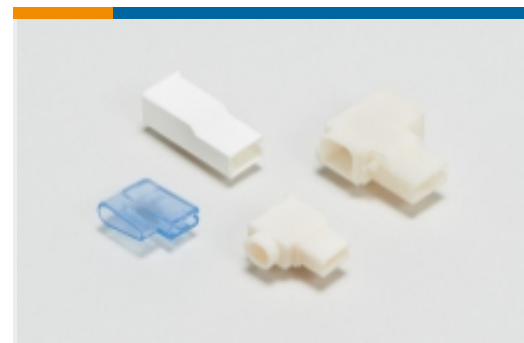

Crimp Terminal Housings(76)



Insertion & Extraction Tools(2)

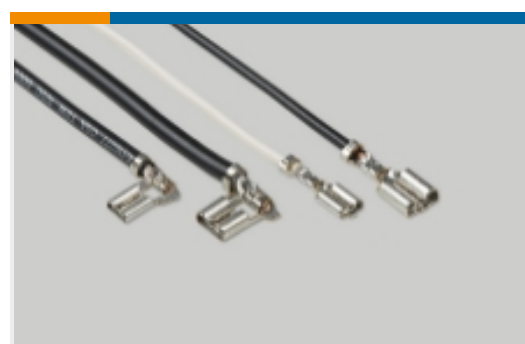

Quick Disconnects(57)

Also in the Series | Positive Lock 250



Automotive Terminals(1)



Crimp Terminal Housings(193)



Insertion & Extraction Tools(3)



Insulation Boots & Sleeves(4)



Quick Disconnects(186)

Customers Also Bought

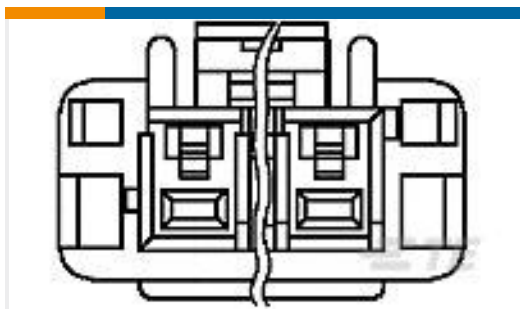

TE Part #1376391-1
5MM POWER KEY 6P PLUG HSG NUT



TE Part #1376397-1
Power Key TPA



TE Part #770084-1
05P .093 COMM P&S PLUG HSG



TE Part #63850-1
187 FASTON REC 20-16 AWG NPST



TE Part #176498-1
POSITIVE LOCK 187 (4.8 MM)
HOUSING

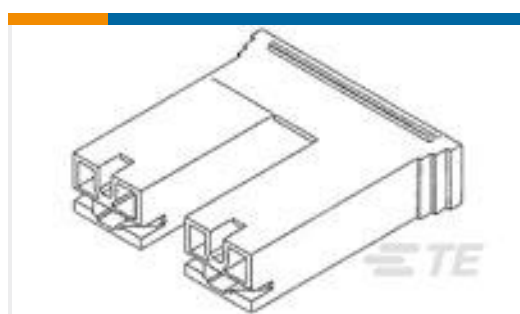

TE Part #1-520935-1
250 HSG. PL MKII REC. 15.11mm 2P
NAT



TE Part #350699-1
UMNL SPLIT PIN PTPBR



TE Part #60650-1
250 FASTON FLAG REC 18-14 AWG
BR

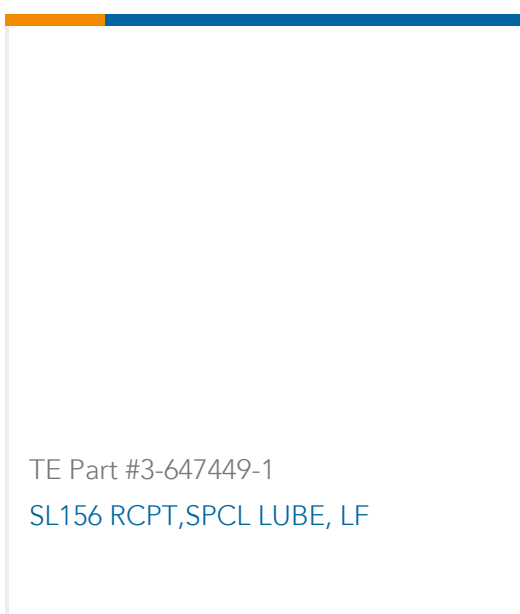

TE Part #3-647449-1
SL156 RCPT,SPCL LUBE, LF

Documents



Product Drawings

PL 250 HOUSING REC RED 6/6 NYLON V2

English

CAD Files

3D PDF

3D

Customer View Model

[ENG_CVM_CVM_1-520935-2_AW.2d_dxf.zip](#)

English

Customer View Model

[ENG_CVM_CVM_1-520935-2_AW.3d_igs.zip](#)

English

Customer View Model

[ENG_CVM_CVM_1-520935-2_AW.3d_stp.zip](#)

English

By downloading the CAD file I accept and agree to the [Terms and Conditions](#) of use.

Datasheets & Catalog Pages

FASTON Housings

English

Positive Lock Receptacles

English

Product Environmental Compliance

TE Material Declaration

English

Agency Approvals

UL Report

English

UL Report

English

UL Report

English