

TMP468EVM and TMP468QFNEVM

This user's guide describes the characteristics, operation, and use of both the TMP468EVM and TMP468QFNEVM evaluation boards. This user's guide discusses how to set up and configure the software, reviews the hardware, and reviews various aspects of the software operation. Throughout this document, the terms *evaluation board*, *evaluation module*, and *EVM* are synonymous with the *TMP468EVM* and *TMP468QFNEVM*. This user's guide also includes information regarding operating procedures, the input and output connections, an electrical schematic, printed-circuit board (PCB) layout drawings, and a parts list for the EVM.



Figure 1. TMP468EVM Top Side



Figure 2. TMP468QFNEVM Top Side



Figure 3. EVM Bottom Side

Contents

1	Overview	3
2	Theory of Operation for the EVM Hardware	4
3	EVM Hardware Overview	5
4	TMP468EVM Software Overview	7
5	EVM Documentation	22

List of Figures

1	TMP468EVM Top Side	1
2	TMP468QFNEVM Top Side	1
3	EVM Bottom Side	1
4	Hardware Included With EVM Kit	3
5	EVM Hardware Overview	4
6	Confirmation of USB-to-I ² C Converter Driver Installation	5
7	EVM Address Pin Hole Connections	6
8	Remote Junction Transistors	6
9	Connection for NPN Transistors Q1 to Q8	6
10	Gallery Home Page	7
11	Cookies Agreement	8
12	TMP468EVM GUI Download From the Gallery	9
13	GUI Composer Runtime Wizard	10
14	TMP468EVM GUI License Agreement	10
15	GUI Composer Installation Directory	11
16	Ready to Install	11
17	Installing GUI Composer Runtime	12
18	TMP468EVM Installation Finish	12
19	TMP468EVM Home Tab	13
20	TMP468EVM Quick Start Tab	14
21	Quick Start Connection Check	15
22	Quick Start Guide	16
23	TMP468EVM Basic Settings Tab	17
24	TMP468EVM Basic Settings Tab	18
25	Threshold Sliders	19
26	TMP468EVM Register Tab	20
27	TMP468EVM Collateral Tab	21
28	EVM Board Schematic	22
29	TMP468EVM Components Layout	23
30	TMP468QFNEVM Components Layout	23

List of Tables

1	EVM Kit Contents	3
2	Related Documentation	3
3	TMP468 Slave Address Options	6
4	EVM Bill of Materials	24

Trademarks

Windows is a registered trademark of Microsoft Corporation.
All other trademarks are the property of their respective owners.

1 Overview

The TMP468 is a high-accuracy, low-power, remote temperature sensor monitor with a built-in, local temperature sensor. The remote temperature sensors are typically low-cost, discrete, NPN or PNP transistors, substrate thermal transistors, or diodes that are integral parts of microprocessors, microcontrollers, or field-programmable gate arrays (FPGAs). Temperature is represented as a 12-bit digital code for both the local and remote sensors, providing a resolution of 0.0625°C. The two-wire serial interface accepts the SMBus communication protocol with up to four different pin-programmable addresses.

1.1 EVM Kit Contents

Table 1 details the contents of the EVM kit, and Figure 4 illustrates all of the included hardware. Contact the Texas Instruments Product Information Center nearest you if any component is missing. It is highly recommended that you check the TI website at <http://www.ti.com> to verify that you have the latest versions of the related software.

Table 1. EVM Kit Contents

ITEM	QUANTITY
PCB test board: TMP468EVM or TMP468QFNEVM	1
USB cable extender	1

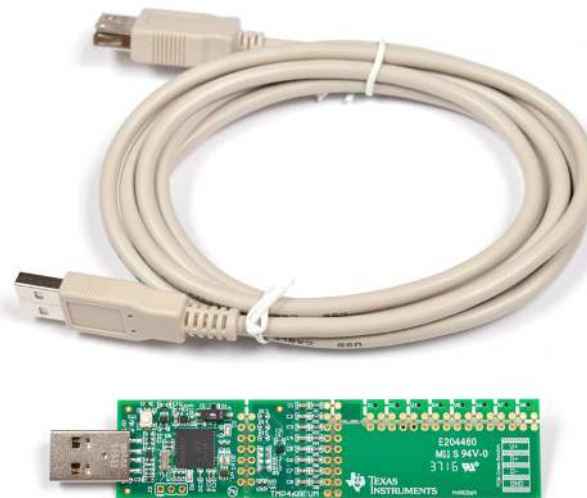

Figure 4. Hardware Included With EVM Kit

1.2 Related Documentation From Texas Instruments

The following documents provide information regarding Texas Instruments integrated circuits used in the assembly of the TMP468EVM and TMP468QFNEVM. This user's guide is available from the TI website under literature number [SBOU184](#). Any letter appended to the literature number corresponds to the document revision that is current at the time of the writing of this document. Newer revisions may be available from the TI website at www.ti.com, or call the Texas Instruments Literature Response Center at (800) 477-8924, or the Product Information Center at (972) 644-5580. When ordering, identify the document by both title and literature number.

Table 2. Related Documentation

DOCUMENT	LITERATURE NUMBER
TMP468 Product Data Sheet	SBOS762

2 Theory of Operation for the EVM Hardware

The EVM consists of three sections that can be separated by breaking the PCB at the perforations. The dashed lines in [Figure 5](#) represent sections of the PCB that can be separated. The left-most section contains a standard USB Type A connector and a [MSP430](#) microcontroller acting as a USB-to-I²C converter. The middle section features the TMP468 device as well as the recommended passive components. The right-most section provides eight discrete transistors that can be used as remote junctions for sensing temperature.

If the left and middle sections of the PCB are separated, they can be reconnected remotely using the 0.1-inch spaced pin holes provided. All of the pin holes serve as test points, and are labeled on the back of the PCB. The middle section featuring TMP468 may be connected to another I²C host for evaluation. In the remote junction section of the PCB, each individual transistor may be separated and re-wired for remote testing.

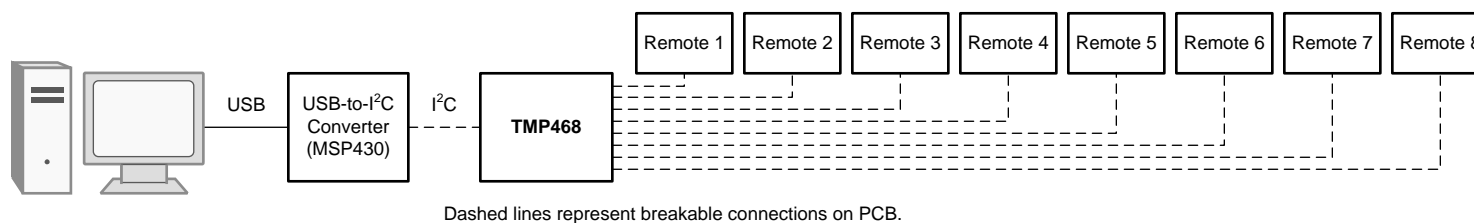

Figure 5. EVM Hardware Overview

3 EVM Hardware Overview

CAUTION

Many components on the EVM are susceptible to damage by electrostatic discharge (ESD). Customers are advised to observe proper ESD handling precautions when unpacking and handling the EVM, including the use of a grounded wrist strap at an approved ESD workstation.

3.1 Connecting the USB Cable to the USB-to-I²C Converter

Figure 6 shows the typical response to connecting the USB-to-I²C converter board to a PC USB port for the first time. Typically, the computer responds with a *Found New Hardware, USB device* pop-up dialog. The pop-up window then typically changes to *Found New Hardware, USB Human Interface Device*. This pop-up indicates that the device is ready to be used. The USB-to-I²C converter uses the human interface device drivers that are part of the Microsoft Windows® operating system.

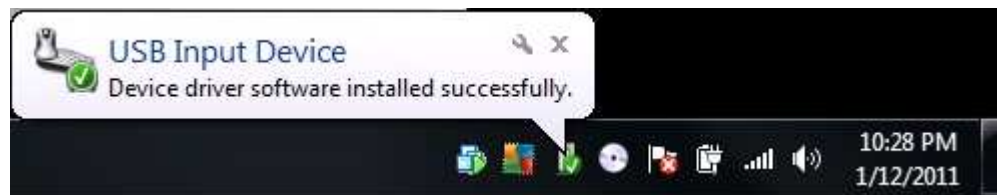

Figure 6. Confirmation of USB-to-I²C Converter Driver Installation

In some cases, the Windows *Add Hardware Wizard* is shown. If this prompt occurs, allow the system device manager to install the human interface drivers by clicking *Yes* when requested to install drivers. Windows confirms installation of the drivers with the message shown in Figure 6.

3.2 EVM Features

This section describes some of the hardware features present on the EVM.

3.2.1 USB-to-I²C Converter Firmware

The USB-to-I²C converter included in the EVM is based on [MSP430F5528](#). The microcontroller is preloaded with firmware that enables its use as a USB-to-I²C converter. Push button SW1 and unpopulated pin hole header J2 are available for BSL and SBW programming, respectively. However, the included firmware is necessary for correct operation of the EVM-GUI software.

3.2.2 USB-to-I²C Converter 3.3-V Regulator

Use switch S1 to disable the onboard 3.3-V regulator. This regulator powers the TMP468 through the test point on the back of the EVM labeled 3.3 V. When the regulator is disabled, the 3.3-V test point can be connected to an external source between 1.7 V to 3.6 V. LED D2 indicates power to the 3.3-V test point, and thus power to the TMP468.

3.2.3 USB-to-I²C Converter THERM Indicators

LEDs D4 and D5 indicate the status of the TMP468 THERM and THERM2 pin holes, respectively. These LEDs are driven by an inverter, therefore the LEDs illuminate when a THERM event is asserted by the TMP468.

3.2.4 TMP468 Serial Bus Address

The TMP468 can be configured for one of four serial bus addresses depending on the state of the ADD pin hole, as shown in Table 3. The EVM ships with resistor R9 populated by a 0-Ω resistor, shown in Figure 7. This R9 resistor sets the default address of the EVM to 48h (hex).

Table 3. TMP468 Slave Address Options

CORRESPONDING EVM RESISTOR	ADD PIN HOLE CONNECTION	SLAVE ADDRESS	
		BINARY	HEX
R9	GND	1001000	48
R10	V+	1001001	49
R11	SDA	1001010	4A
R12	SCL	1001011	4B



Figure 7. EVM Address Pin Hole Connections

3.2.5 Shunt Resistor

Shunt resistor R13 connects directly to the TMP468 device. R13 can be removed or replaced in order to directly measure the current consumption of the TMP468 device.

3.2.6 RC Filter

Each remote channel features an RC Filter. Resistors R1 through R8 and capacitors C1 through C8 comprise the RC filter for each respective channel.

3.2.7 Remote Junction Transistors

The EVM features eight MMBT3904LP transistors for use as remote temperature sensors. Each transistor is perforated so that it can be separated from the EVM, as shown in Figure 8. The schematic connections for each transistor section is shown in Figure 9.



Figure 8. Remote Junction Transistors

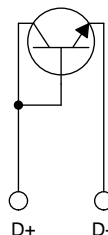

Figure 9. Connection for NPN Transistors Q1 to Q8

4 TMP468EVM Software Overview

This section discusses how to install the EVM software.

4.1 TMP468EVM Software Installation

The EVM software is tested on both the Microsoft Windows 7 and 10 operating system (OS). The software also functions on other Windows operating systems. The EVM software is available through the EVM product folder on the TI website through the hyperlink. The hyperlink will redirect to the TI Cloud where a common repository of all published applications using GUI Composer framework. The applications can run directly from the Gallery with minimal install, or can be downloaded from the Gallery with runtime to run on a desktop local machine. The applications is supported to use on many platforms (web, Windows, Linux, OSX); however, Linux and OSX might require additional drivers. To download the software to your system, follow the instructions below.

4.1.1 Running GUI Online

Go to the TMP468EVM web page on the TI website: <http://www.ti.com/tool/TMP468EVM>. Scroll down to the “Software” section and click on the hyperlink to download the latest evaluation software, or go to <http://dev.ti.com/gallery/> for a direct link to the Gallery. It might require login user account privileges to use the online version, as well as the installation of the applications. On the top-middle of the Gallery main page, navigate to the search box and type TMP468EVM GUI as shown in Figure 10.

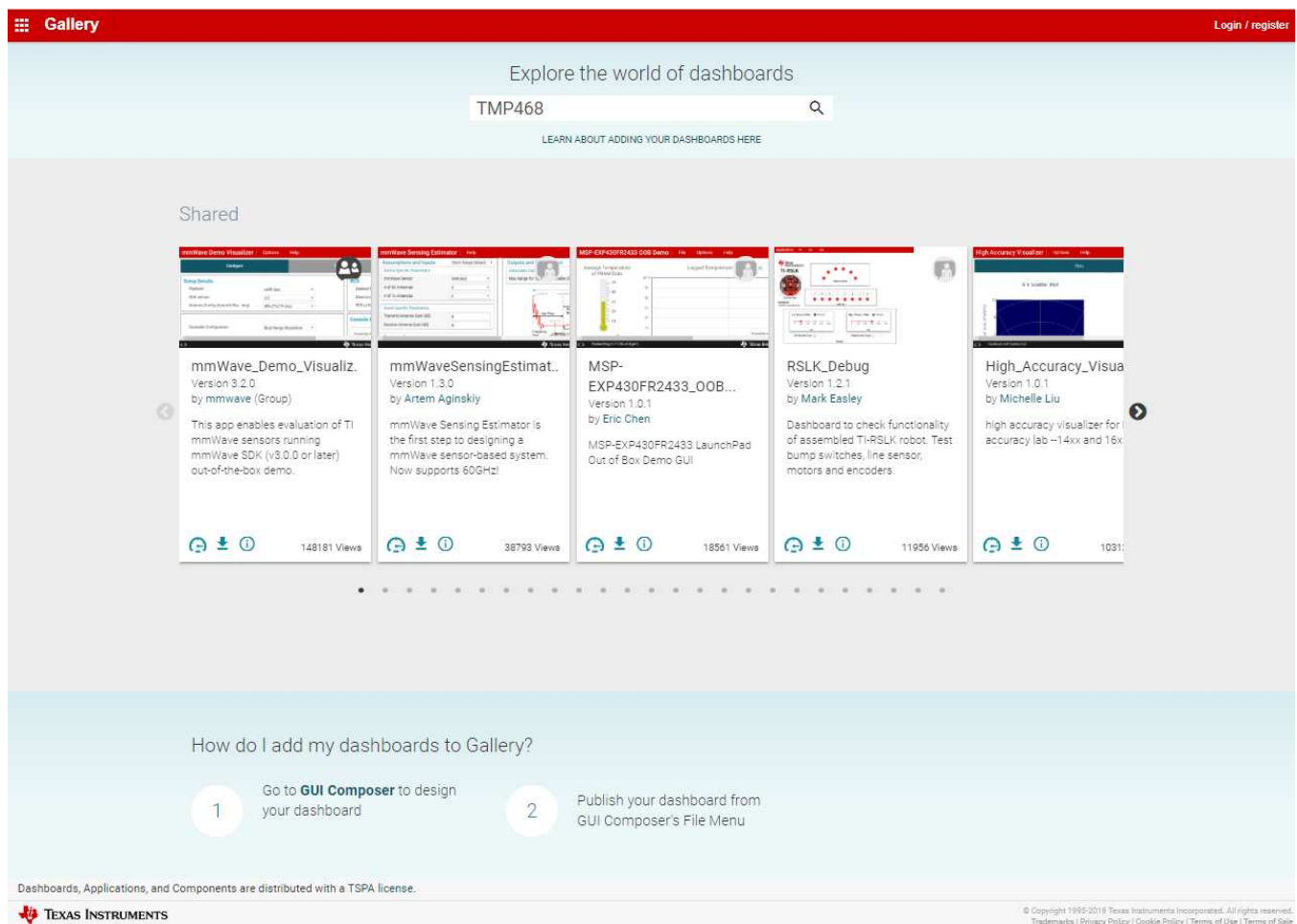

Figure 10. Gallery Home Page

Click on the TMP468EVM GUI icon. Users may be prompted to download and install the browser extensions for Firefox or Chrome, and the TI Cloud Agent Application for the first time. Click on Agree and Proceed. After this, the TMP468GUI should launch in your browser window.

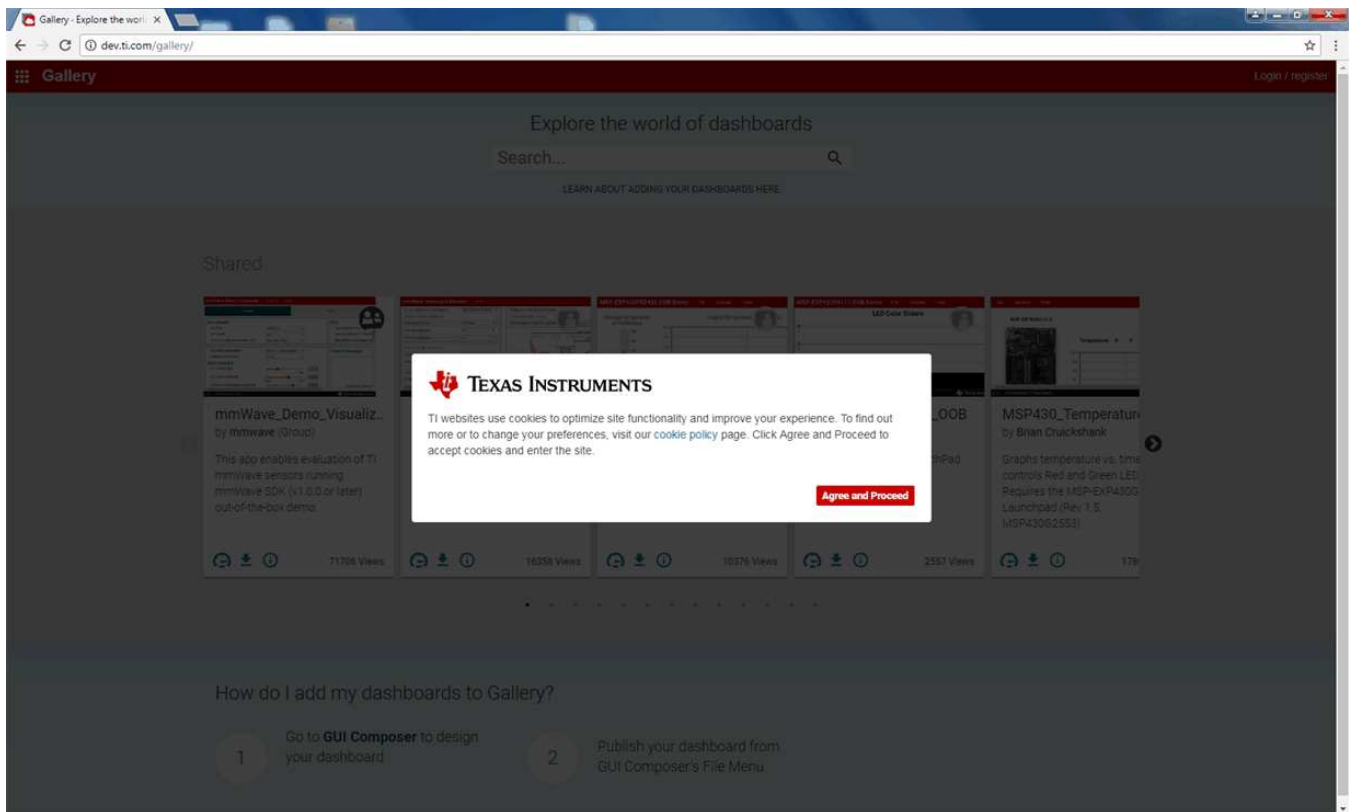

Figure 11. Cookies Agreement

4.1.2 Running GUI on Desktop

In the TMP468EVM GUI icon, click on the download icon to download the TMP468EVM_GUI_installer_win.zip. When the pop-up screen appears, select the desired platform to install into your local machine as shown in [Figure 12](#).

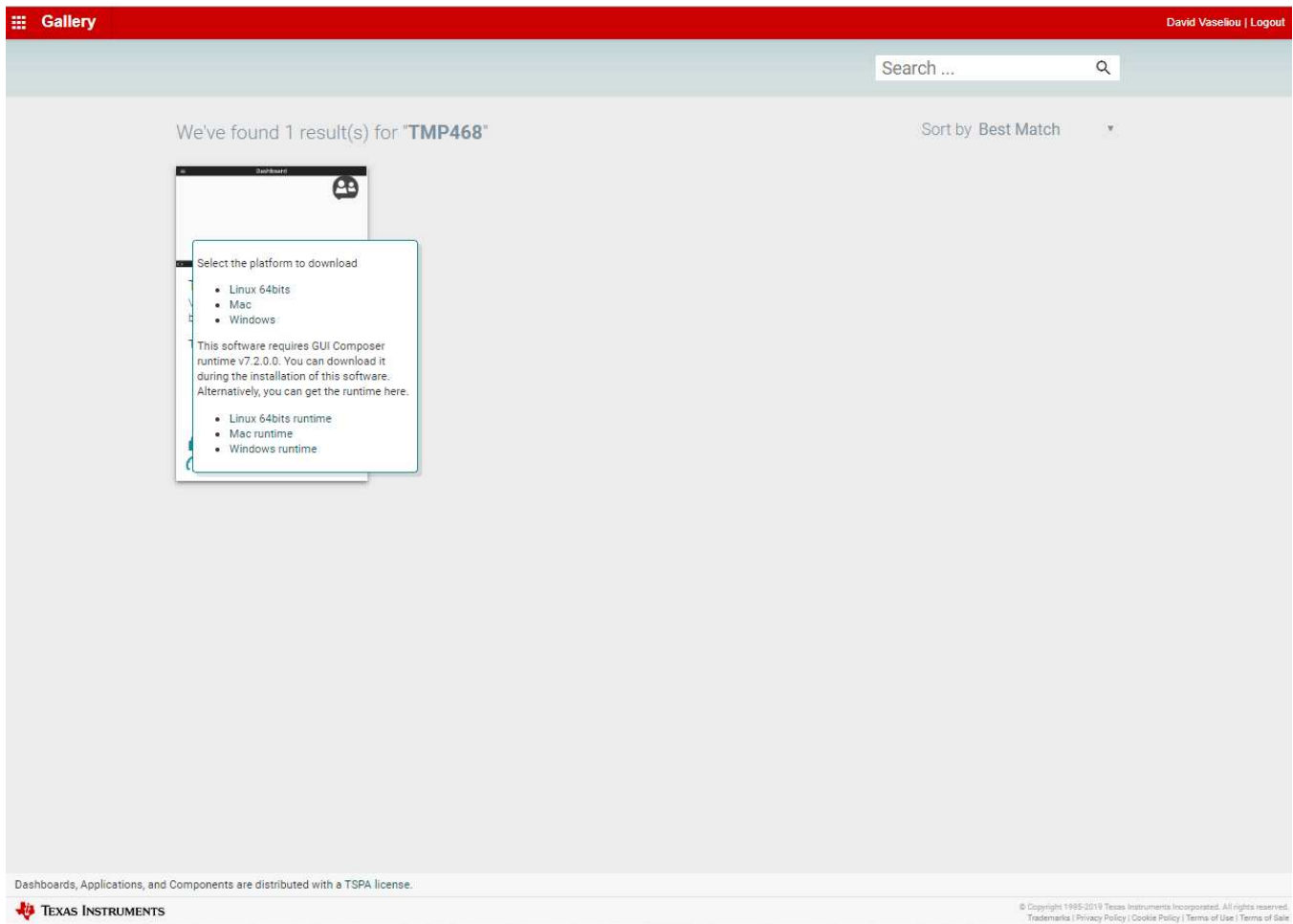

Figure 12. TMP468EVM GUI Download From the Gallery

Unzip the downloaded file into a known directory, and run the “TMP468EVM_GUI-1.0.0.setupwin_7.2.0.exe” file located in [Unzipped location]. The EVM software installer then begins the installation process. Follow the on-screen instructions by clicking the “Next” button to install the GUI Composer runtime engine. If it is the first-time installation, the TMP468EVM GUI requires the GUI Composer runtime engine v7.2 to operate properly.

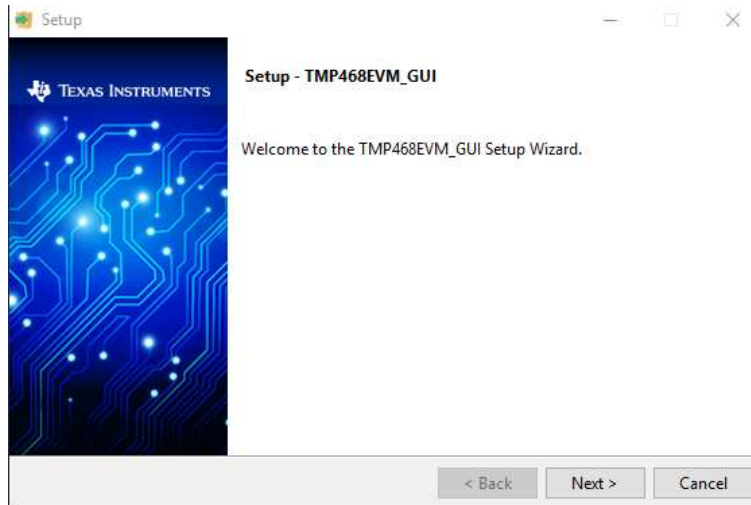

Figure 13. GUI Composer Runtime Wizard

Read through the License Agreement, click the checkbox if you agree, and click "Next".

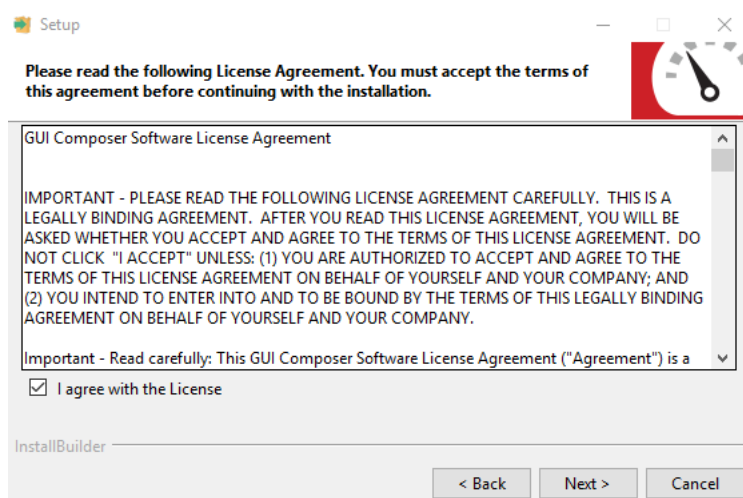

Figure 14. TMP468EVM GUI License Agreement

Click on the "Next" button to accept the default installation directory. Installation takes some time to complete.

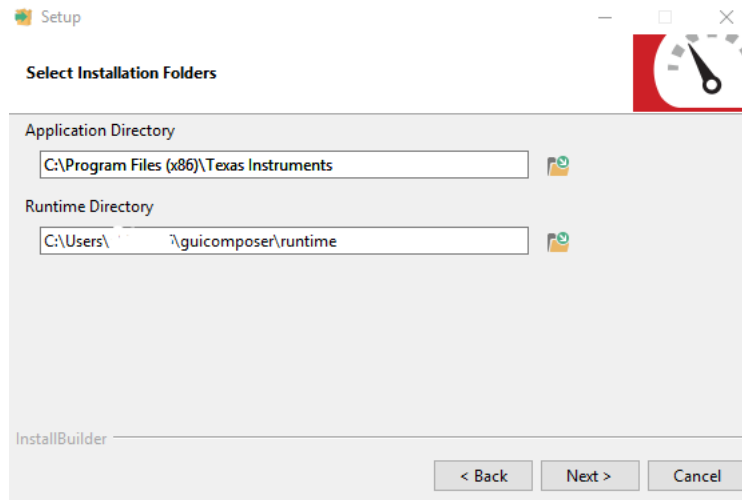

Figure 15. GUI Composer Installation Directory

Click "Next" to start the installation.

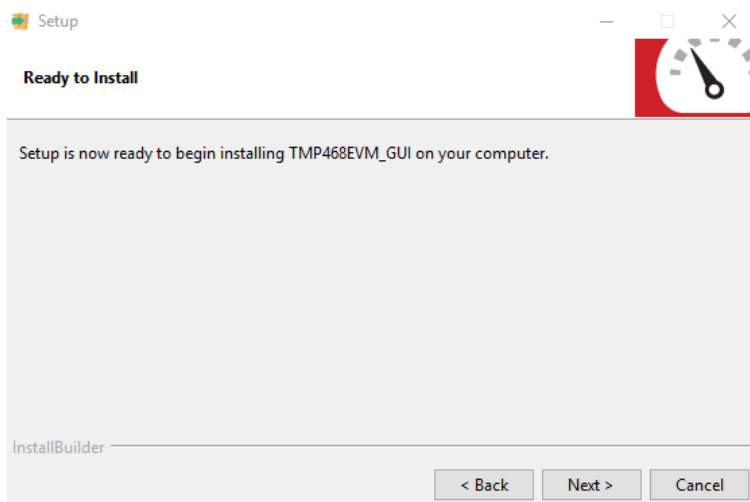

Figure 16. Ready to Install

The TMP468EVM GUI will start to install as shown in [Figure 17](#)

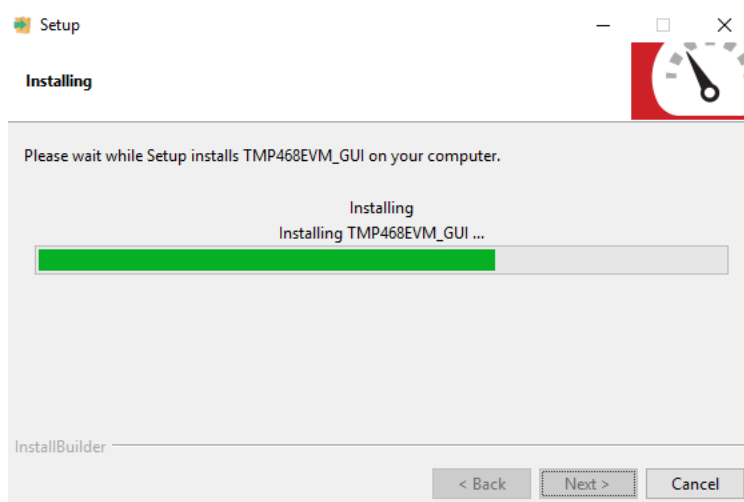

Figure 17. Installing GUI Composer Runtime

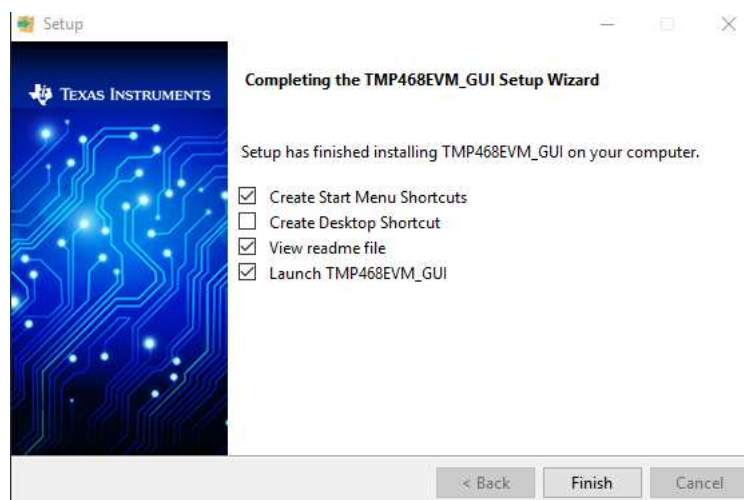

Figure 18. TMP468EVM Installation Finish

Read the readme file and close it out after you are done. If you choose to Launch TMP468_GUI, it should launch shortly after closing the readme file.

4.2 Using the TMP468EVM Software

4.2.1 Launching and Running the Software

The TMP468EVM GUI can be run from TI Cloud repository (<http://dev.ti.com/gallery/>) from the Firefox or Chrome browser, or from Windows desktop offline. Start the launch by connecting the TMP468EVM to a USB port on a PC.

Launch the TMP468EVM software by clicking on the TMP468EVM GUI icon in the Gallery or the Windows offline app. The TMP468EVM GUI should automatically initialize and connect to the HID port. A successful connection will show “HARDWARE CONNECTED” on the bottom of the GUI status indicator. If there is a connection problem, verify if the TMP468EVM has an established connection with the PC. If the GUI failed to connect, the status indicator shows as “HARDWARE NOT CONNECTED”.

Once connected to the GUI, the software will change the default settings of the N-Factor Correction and will unlock the registers for user convenience. If the user tries to write to the device while the register map is locked, the device will send a NACK which will disconnect the device from the GUI. The software updates the N-Factor to more closely reflect the N-Factor of the transistors on the EVM. Further adjustments to the N-Factor correction register may be needed as N-factor of the transistors can vary.

4.2.2 Home Tab

When the TMP468EVM GUI is launched, the Home tab will be selected and shown by default. You can navigate to any one of the other five tabs on this page. On the left, you will see the tab bar that will be available on every tab in the GUI. Clicking on a tab icon will bring you to the respective tab. On the bottom, you will see the same list of icons with a short description of each of the tabs. Similarly to the tab bar icons, these icons will also bring you to the respective tab.

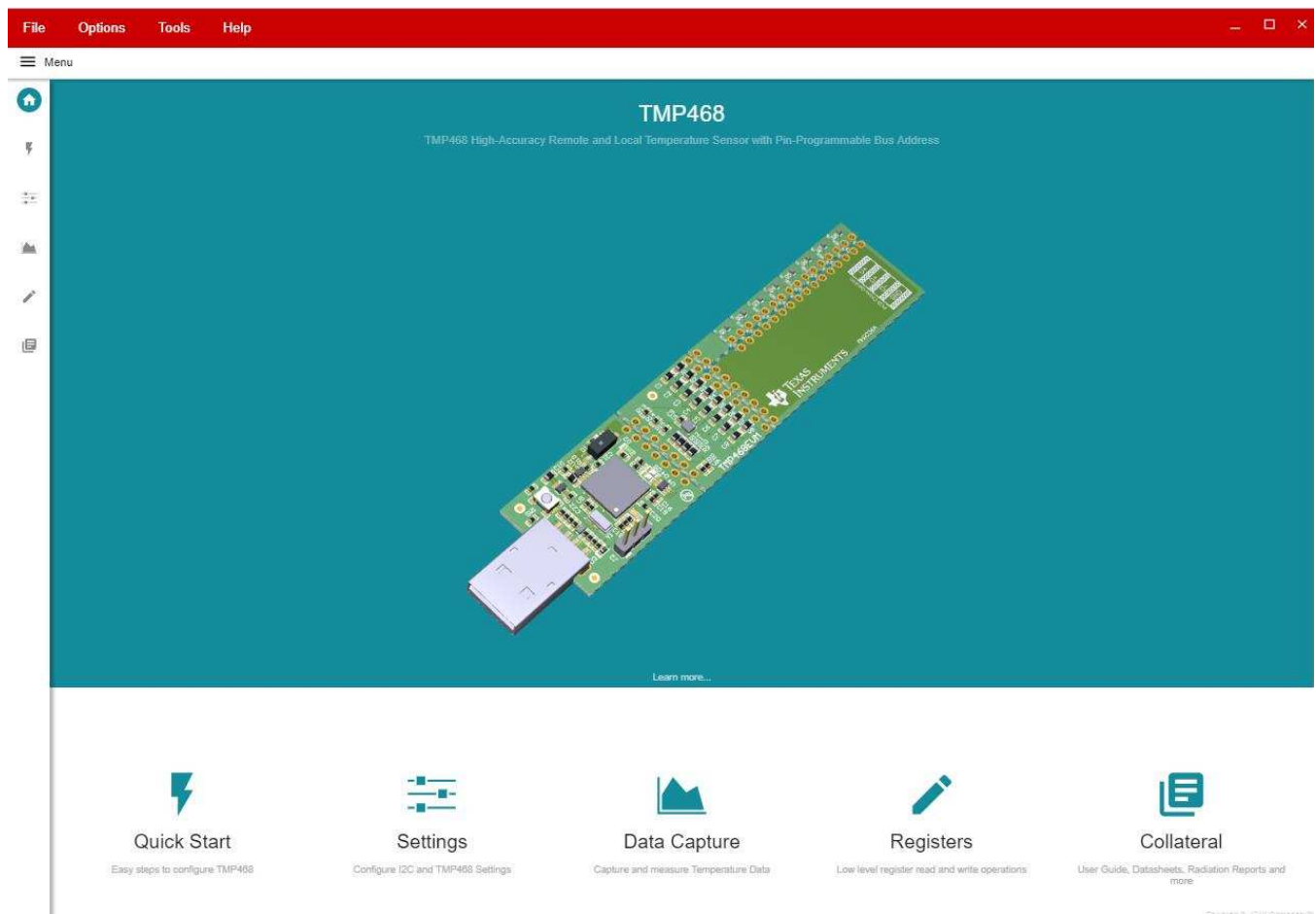

Figure 19. TMP468EVM Home Tab

4.2.3 Quick Start Tab

The Quick Start Tab is used to guide the user through the basic settings of the TMP468EVM. The user can choose to either use default settings or be guided through the setup. Choosing to use default settings will take you straight to the Data Capture Tab. After choosing default settings, the user can always go back to the Quick Start Tab and choose to be guided through the setup or change the device settings in the Basic Settings Tab.

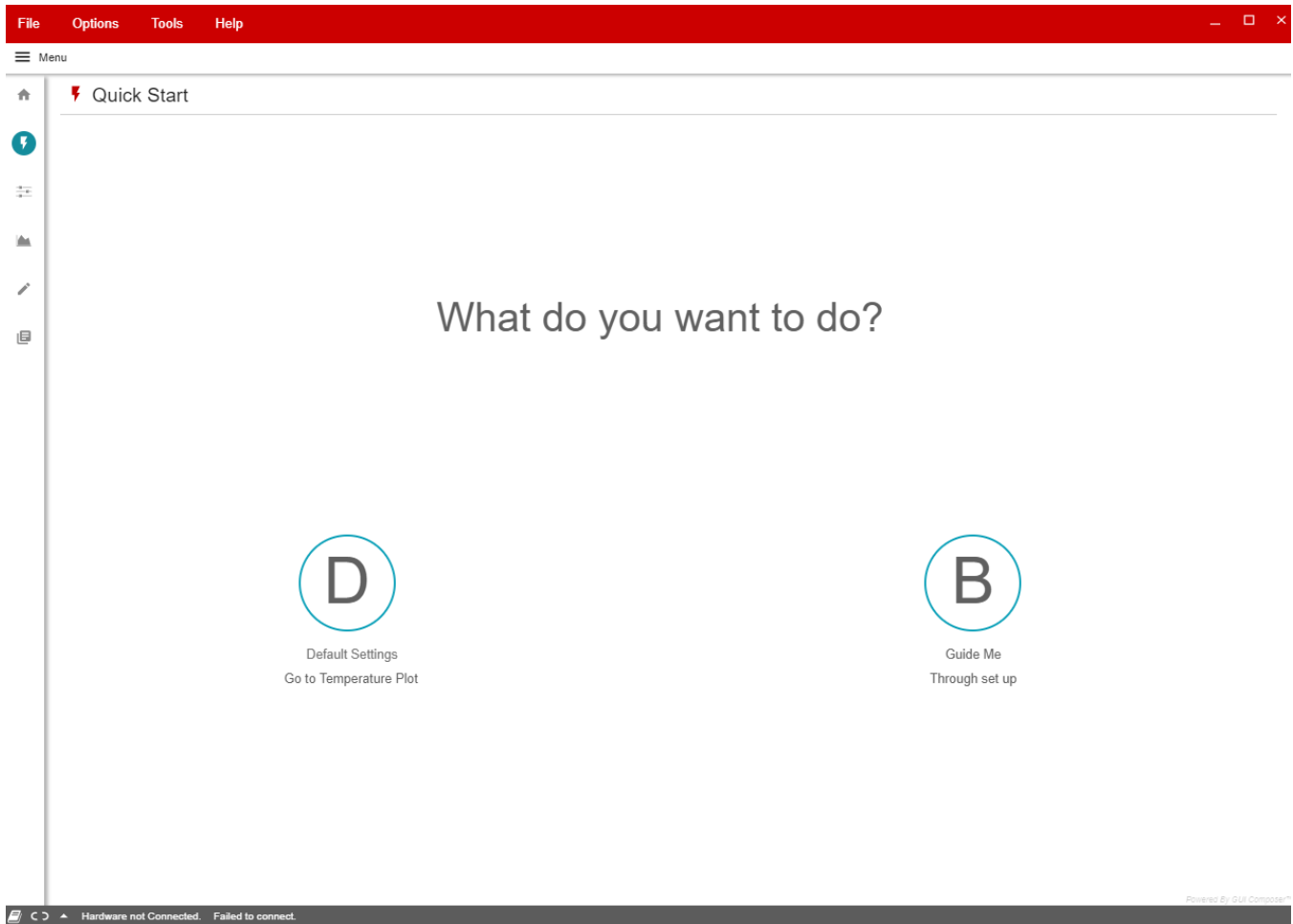

Figure 20. TMP468EVM Quick Start Tab

If you choose to be guided through the setup, you will see a page that will make sure the TMP468EVM is connected correctly. Select the I2C address that correlates to in which the ADD pin is set. If it is connected correctly, click the "YES" button and a list of high-level settings to configure will appear as seen in Figure 22.

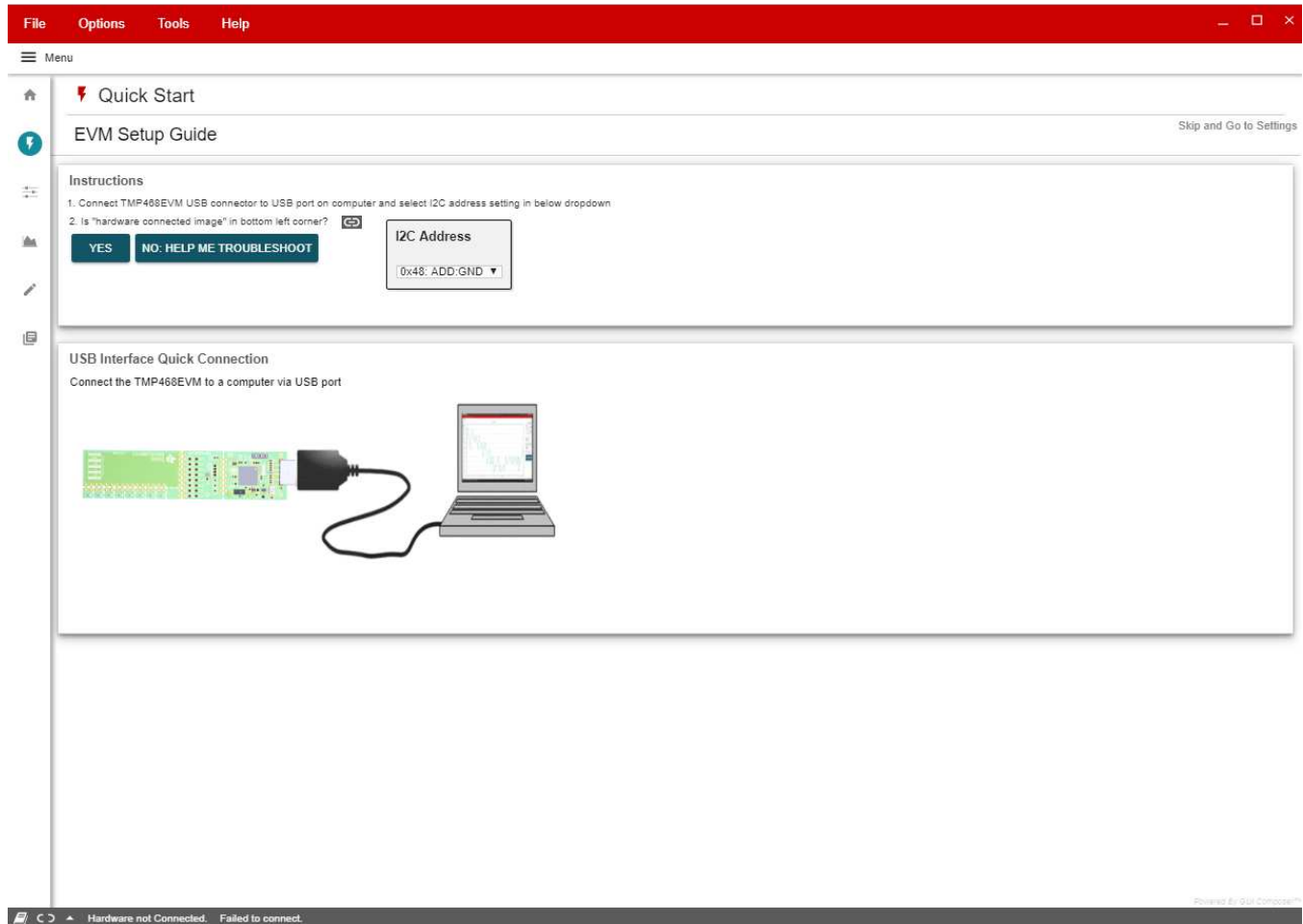

Figure 21. Quick Start Connection Check

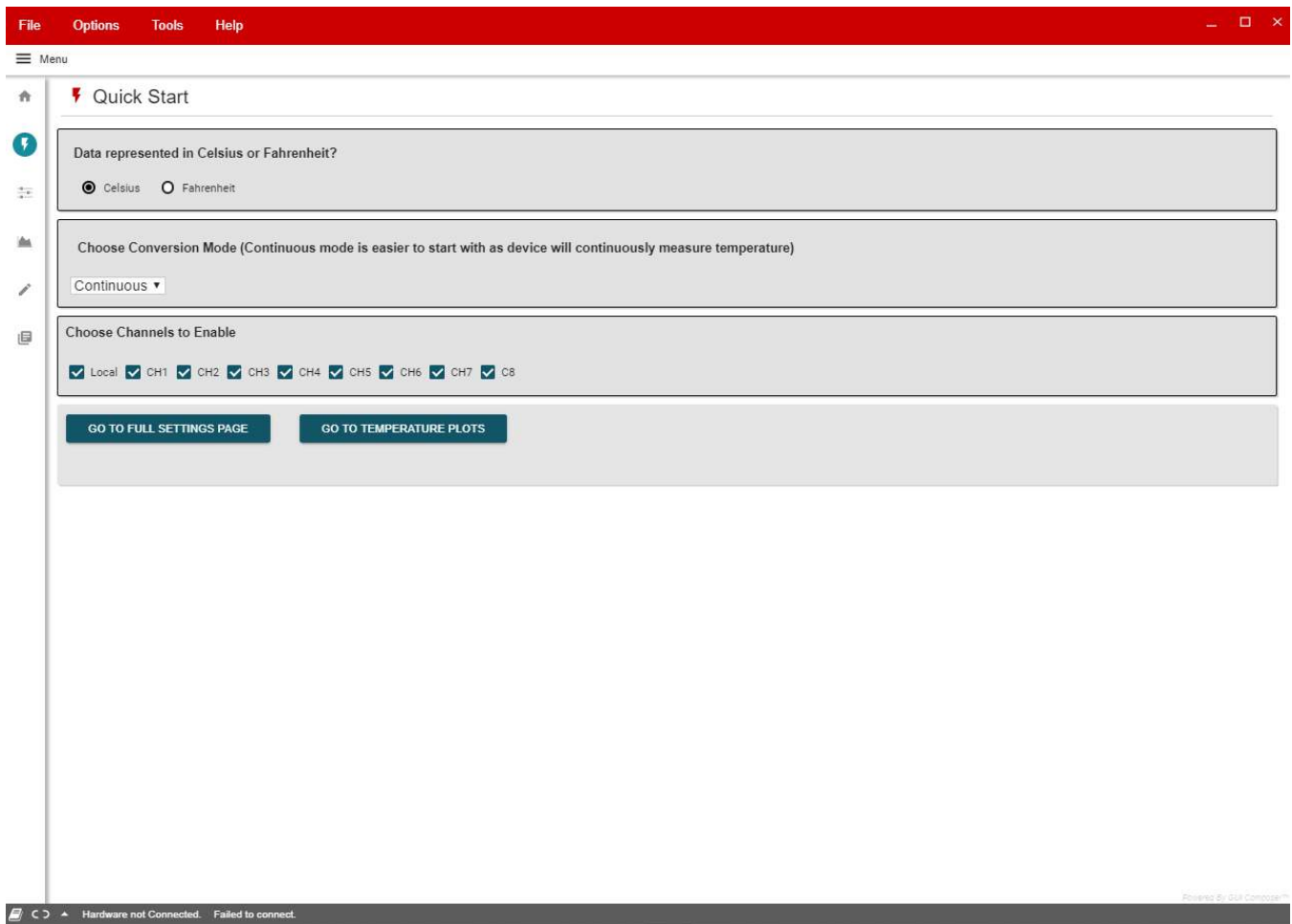

Figure 22. Quick Start Guide

At the bottom of these settings, you will see a choice to go to the Basic Settings tab where a more extensive list of settings will be, or go to the Data Capture tab.

4.2.4 Basic Settings Tab

The Basic Settings tab is where all the device settings along with I2C settings are configured.

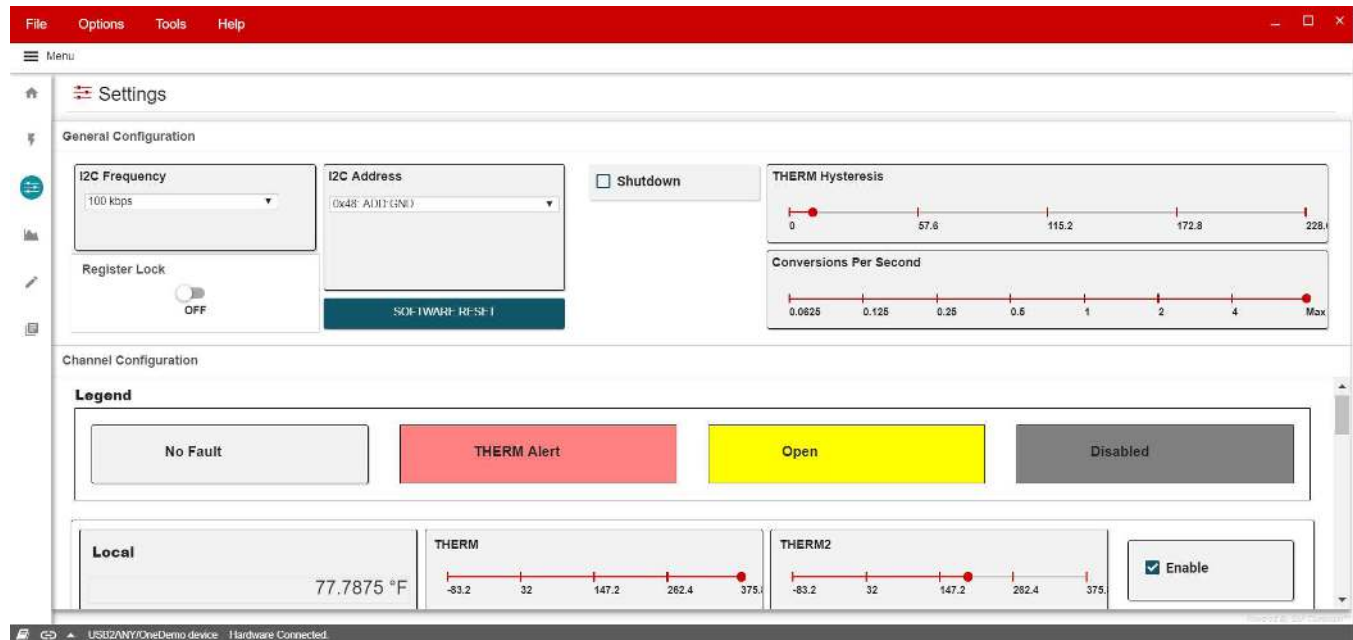

Figure 23. TMP468EVM Basic Settings Tab

4.2.4.1 I2C Configuration

I2C Frequency: this drop-down sets the I2C clock frequency to either 100 kbps or 400 kbps

I2C Address: this displays the I2C address of the TMP468

Software Reset: clicking this push button will send a software reset to the device

Register Lock: this toggle switch will lock or unlock the registers

4.2.4.2 Device Configuration

Shutdown: setting this checkbox will place the device into shutdown mode

Conversion per second: this slider will set how many temperature conversions the TMP468 will perform per second

THERM Hysteresis: this slider will set the THERM hysteresis value

4.2.4.3 Channel Configuration

The TMP468EVM has one local channel and eight remote channels. The Channel Configuration section is where the settings for specific channels can be configured.

4.2.4.3.1 Local

Temperature Reading: displays the temperature of the channel

THERM Limit: this slider sets the THERM limit threshold

THERM2 Limit: this slider sets the THERM2 limit threshold

Enable: this checkbox will enable this channel to calculate new temperature data during a conversion cycle

4.2.4.3.2 Remote1-8

Temperature Reading: displays the temperature of the channel

THERM Limit: this slider sets the THERM limit threshold

THERM2 Limit: this slider sets the THERM2 limit threshold

Remote Offset: this number spinner will set the temperature offset of the remote channel temperature reading

N-Factor Correction: this number spinner is used to adjust for the N-factor of the remote BJT. Set this spinner to the N-factor of the remote BJT that is connected to the TMP468EVM

Enable: this checkbox will enable this channel to calculate new temperature data during a conversion cycle

4.2.5 Data Capture Tab

The Data Capture Tab is where the temperature readings as well as the set temperature thresholds will be graphed.

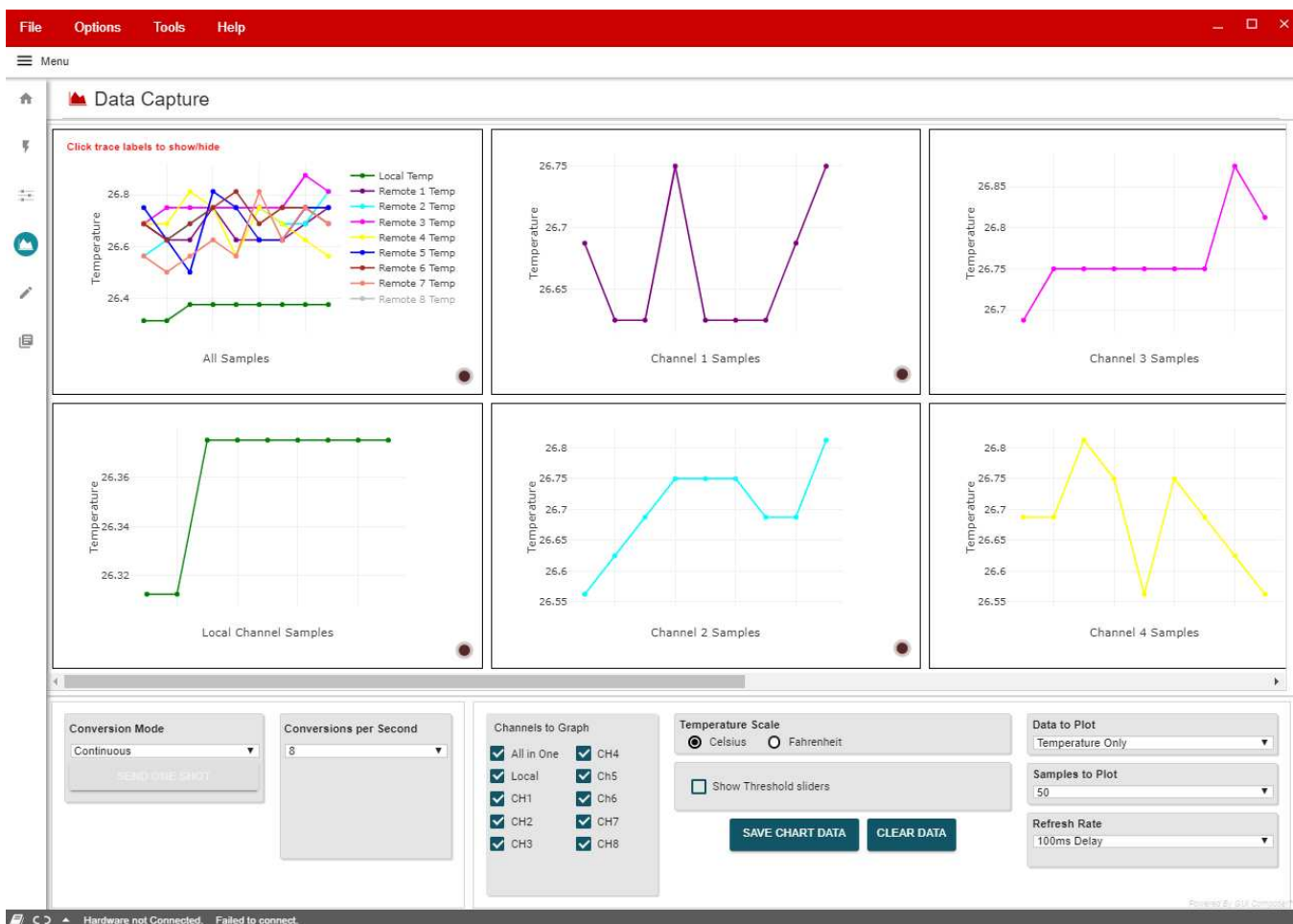

Figure 24. TMP468EVM Basic Settings Tab

In the bottom-left of the Data Capture tab, there is a list of some device configurations that are also found on the Basic Settings tab with the addition of the "SEND ONE SHOT" button. This button will enable only when the conversion mode is set to "Shutdown." When this button is clicked, a One Shot command will be sent to the device and a single temperature conversion will be done.

At the bottom-right of the Data Capture tab, there are the GUI settings. These settings change how the GUI will handle the data collected from the TMP468EVM.

Channels to Graph: these checkboxes enable and disable specific channels as well as hide the respective graph

Temperature Scale: this radio button group sets the units the temperature information is displayed

Show Threshold Sliders: setting this check box will show the threshold sliders to the right of the graph as well as displays for the temperature readings

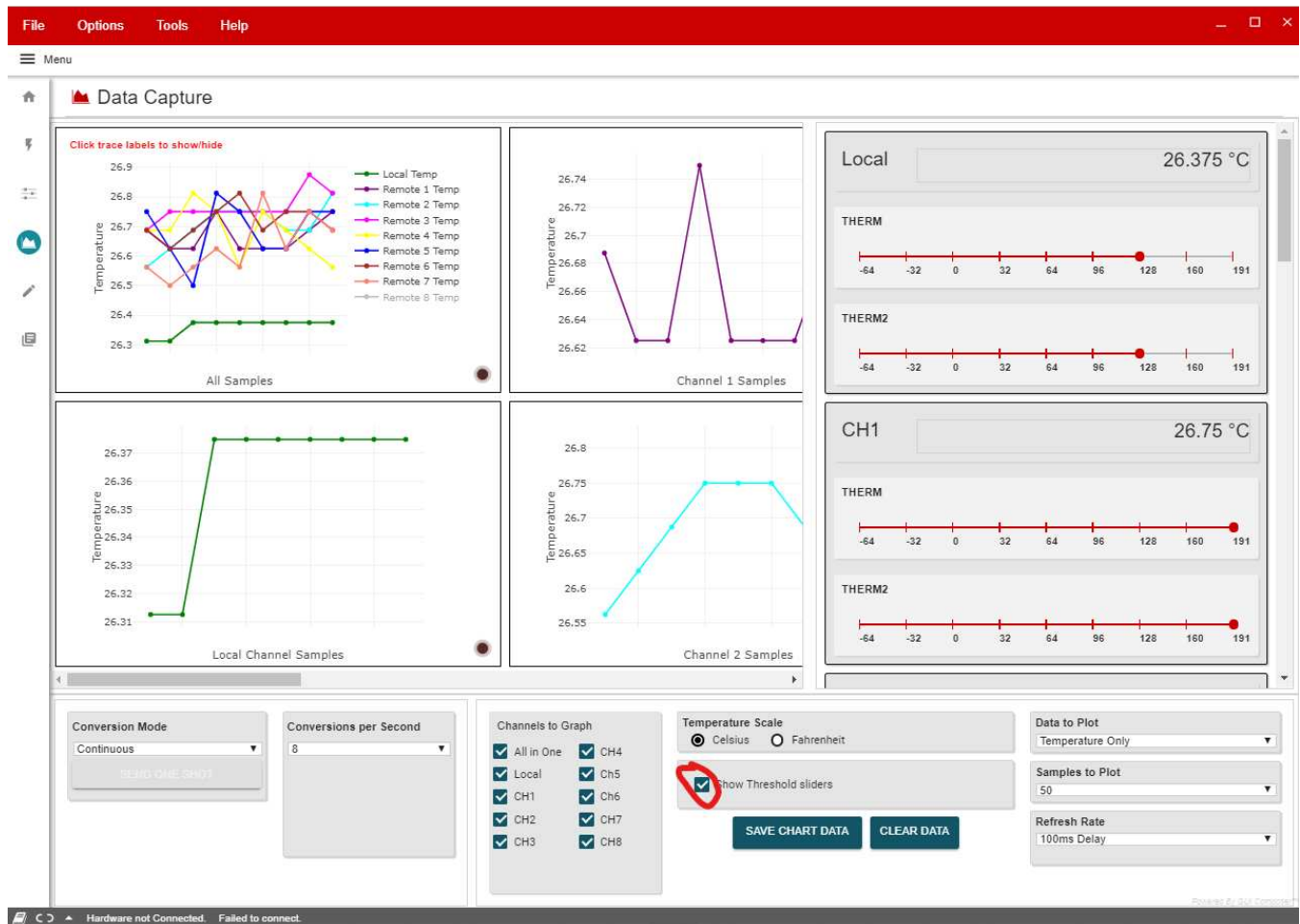

Figure 25. Threshold Sliders

Graph: this is where the temperature data and thresholds are plotted. Clicking on the traces in the legend at the top-right will hide/show different traces. Hovering over the graph will display different point information, and other feature icons will appear at the top-right.

Data to Plot: this drop-down determines which data is plotted on the graph

Samples to Plot: this drop-down sets how many samples are plotted on the graph

Refresh Rate: this drop-down sets the desired time frame to fetch the register data. This is directly tied to the Auto-read drop-down on the Register Tab

Save Data: clicking this button will save the plotted data into an .csv file

Clear Data: clicking this button will clear all the data that is plotted on the graph

4.2.6 Register Tab

The Register Map page shown in [Figure 26](#) allows low-level access to all the I2C registers of the TMP468 device. Clicking on the question mark to the right of the Register Name will bring up an extraction short version from the data sheet describing that register. Clicking on a specific Register Name will populate the Field View to on the right side of the screen. The Field View describes each bit field within that register. The “Registers” tab provides access to the registers raw data of the TMP468. Changes to the basic settings page are mirrored here, and vice versa.

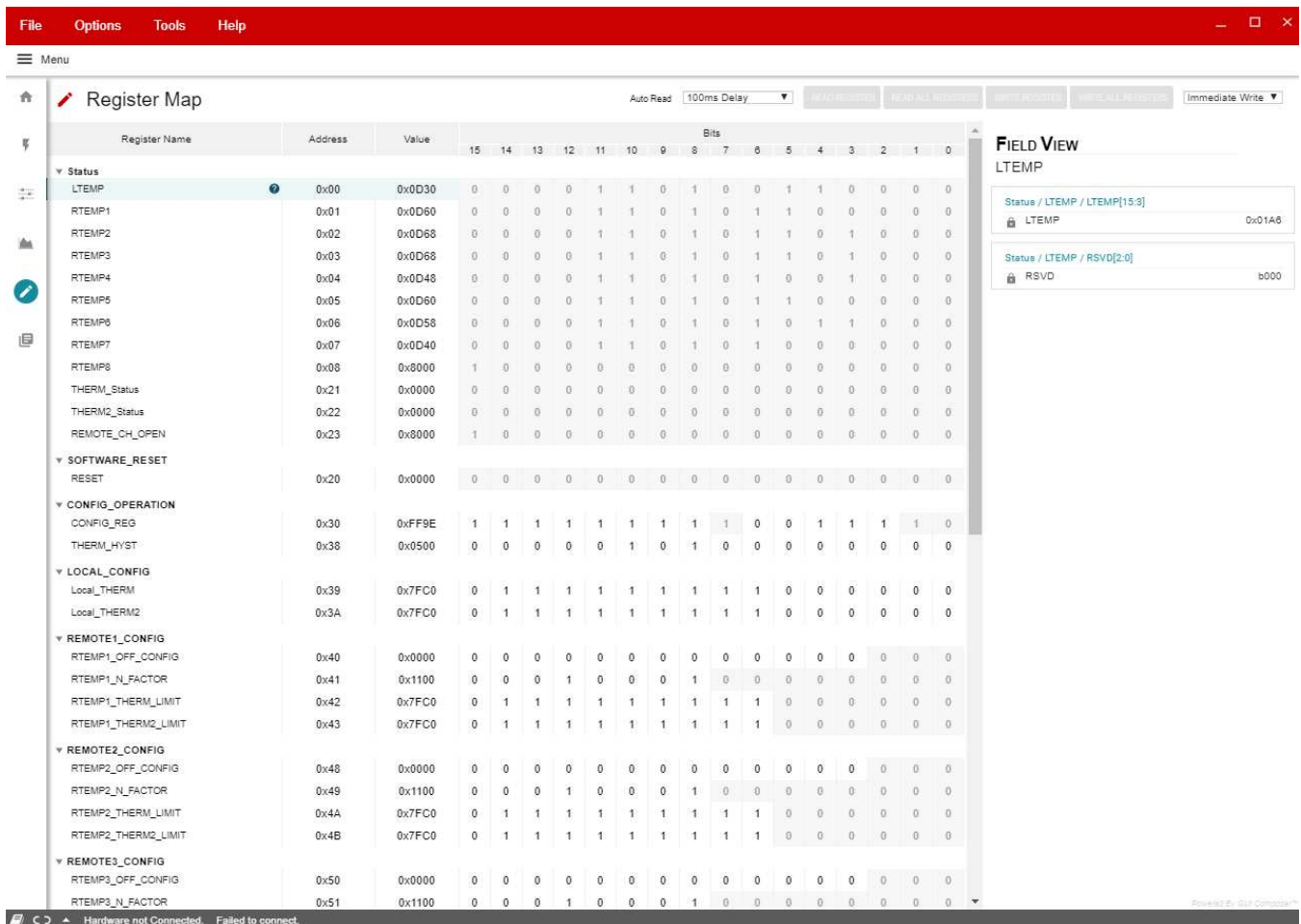

Figure 26. TMP468EVM Register Tab

Read Registers: performs a single read for the selected register.

Read All Registers: performs a read for all registers contents.

Auto Read: allows the user to set the desired time frame to fetch the register data.

4.2.7 Collateral

The Collateral Tab as shown in [Figure 27](#) contains links to web documents pertinent to the TMP468EVM. The page is divided into four sections: (1) User Guide, (2) Datasheet, (3) Application Notes, and (4) MSP432 Firmware.

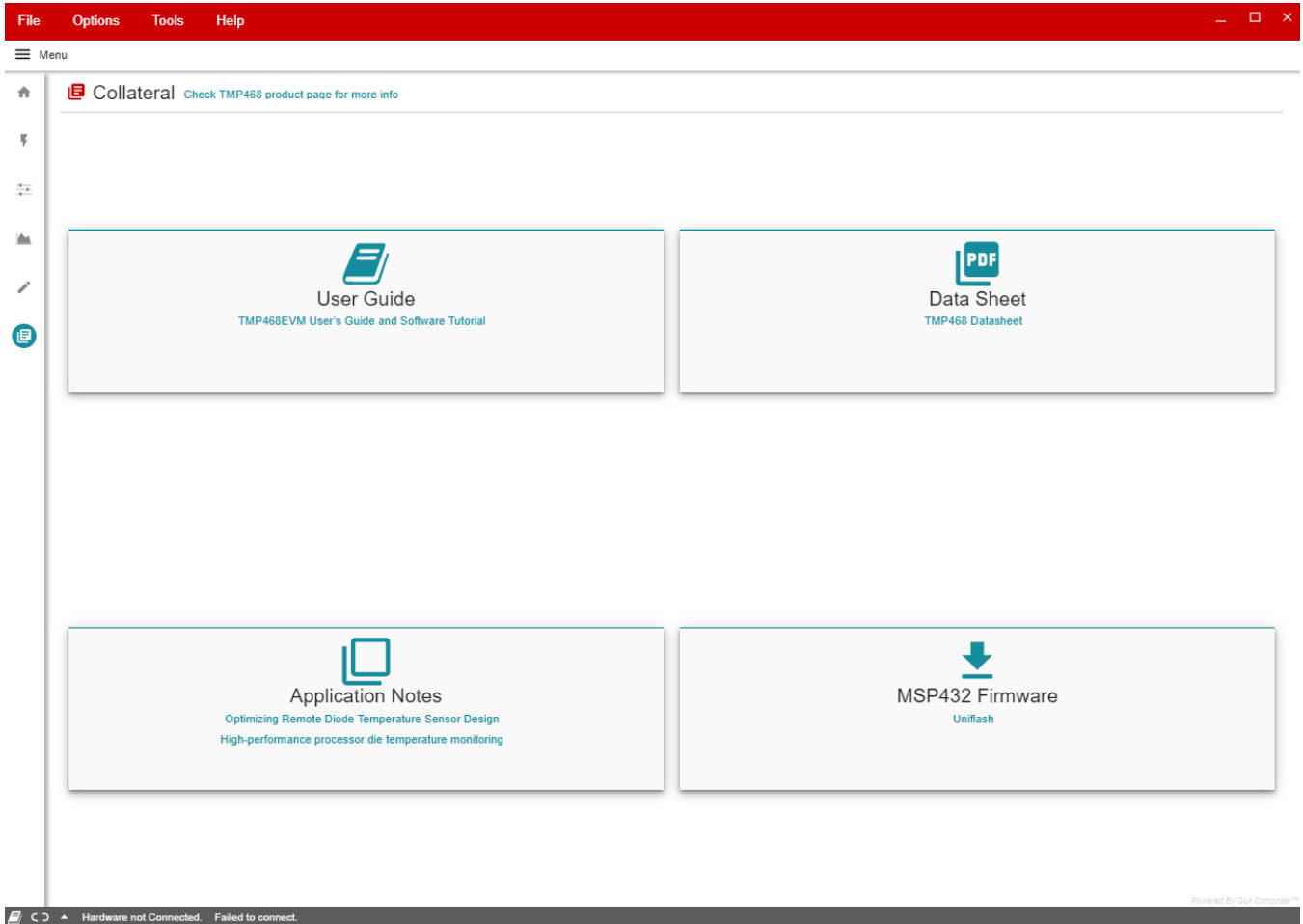

Figure 27. TMP468EVM Collateral Tab

5 EVM Documentation

This section contains the schematic diagram, layout, and complete bill of materials (BOM) for the EVM.

5.1 EVM Board Schematic

Figure 28 shows the schematic for the TMP468EVM board. The TMP468QFNEVM board is the same, except that U1 is labeled TMP468AIRGTR.

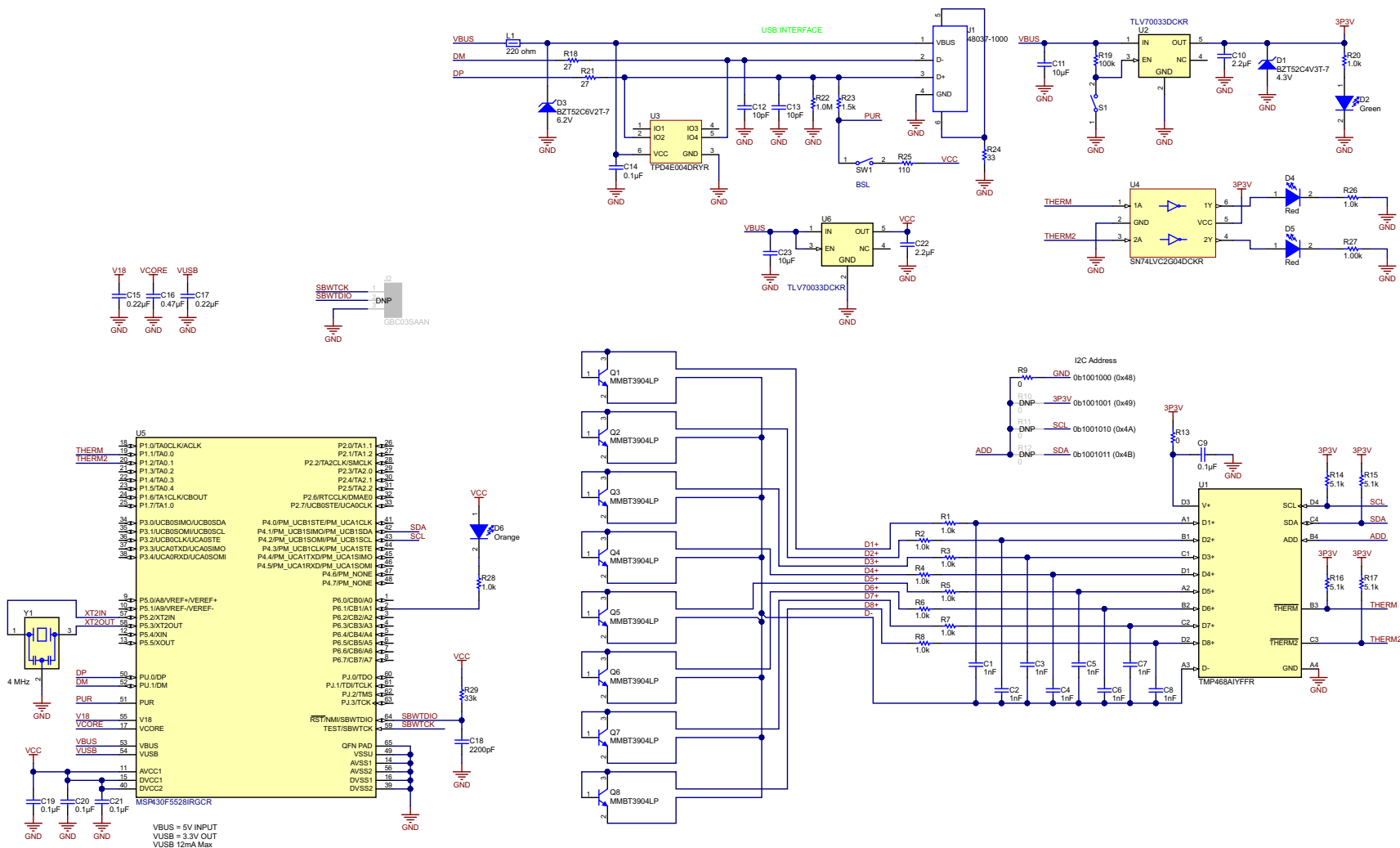

Figure 28. EVM Board Schematic

5.2 EVM PCB Components Layout

Figure 29 shows the layout of the components for the TMP468EVM board. Figure 30 shows the layout of the components for the TMP468QFNEVM board.

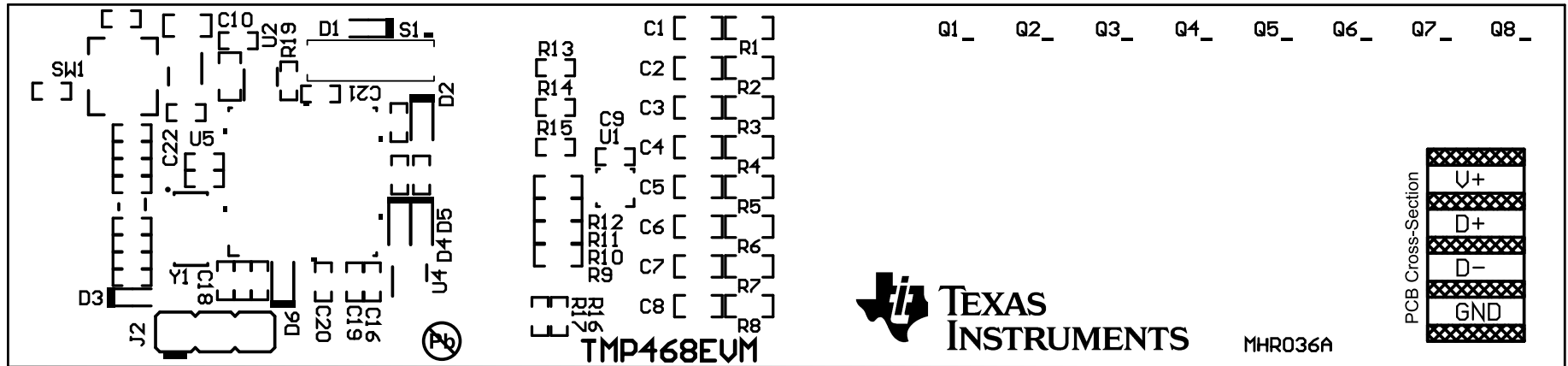

Figure 29. TMP468EVM Components Layout

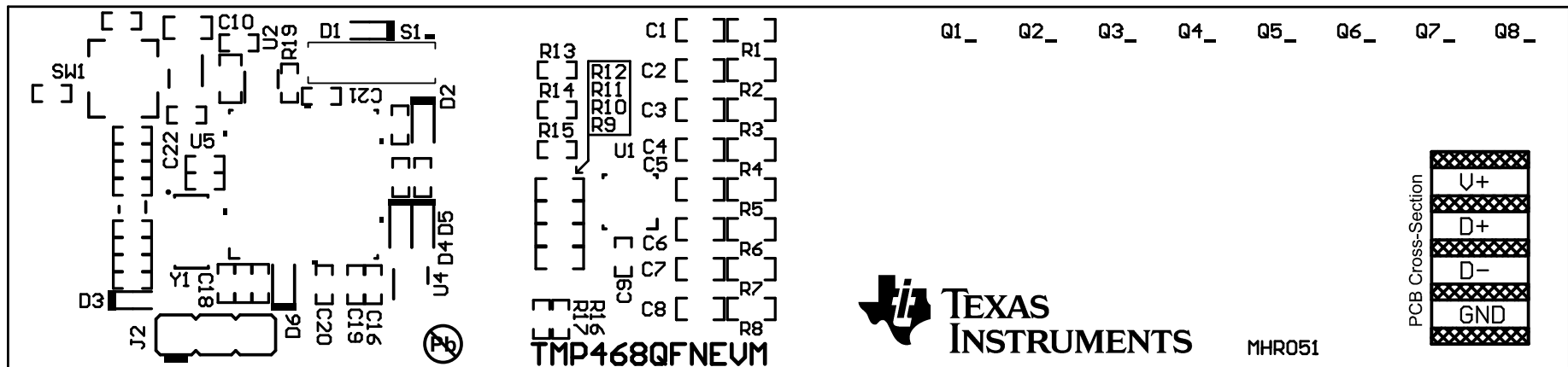

Figure 30. TMP468QFNEVM Components Layout

5.3 EVM Bill of Materials

Table 4 lists the bill of materials for the EVM.

Table 4. EVM Bill of Materials

DESIGNATOR	QUANTITY	VALUE	DESCRIPTION	PACKAGE REFERENCE	PART NUMBER	MANUFACTURER
!PCB1	1		Printed-Circuit Board		MHR036 or MHR051	Any
C1, C2, C3, C4, C5, C6, C7, C8	8	1000 pF	CAP, CERM, 1000 pF, 50 V, +/- 5%, C0G/NP0, 0603	0603	C0603C102J5GACTU	Kemet
C9, C14, C19, C20, C21	5	0.1 uF	CAP, CERM, 0.1 μF, 16 V, +/- 5%, X7R, 0402	0402	GRM155R71C104JA88D	MuRata
C10, C22	2	2.2 uF	CAP, CERM, 2.2 μF, 16 V, +/- 10%, X5R, 0402	0402	GRM155R61C225KE11D	MuRata
C11, C23	2	10 uF	CAP, CERM, 10 μF, 10 V, +/- 20%, X5R, 0603	0603	C1608X5R1A106M080AC	TDK
C12, C13	2	10 pF	CAP, CERM, 10 pF, 50 V, +/- 5%, C0G/NP0, 0402	0402	GRM1555C1H100JA01D	MuRata
C15, C17	2	0.22 uF	CAP, CERM, 0.22 μF, 10 V, +/- 10%, X5R, 0402	0402	C1005X5R1A224K050BC	TDK
C16	1	0.47 uF	CAP, CERM, 0.47 μF, 10 V, +/- 10%, X5R, 0402	0402	GRM155R61A474KE15D	MuRata
C18	1	2200 pF	CAP, CERM, 2200 pF, 6.3 V, +/- 10%, X5R, 0402	0402	GRM155R60J222KA01D	MuRata
D1	1	4.3 V	Diode, Zener, 4.3 V, 300 mW, SOD-523	SOD-523	BZT52C4V3T-7	Diodes Inc.
D2	1	Green	LED, Green, SMD	LED_0603	LTST-C191TGKT	Lite-On
D3	1	6.2 V	Diode, Zener, 6.2 V, 300 mW, SOD-523	SOD-523	BZT52C6V2T-7	Diodes Inc.
D4, D5	2	Red	LED, Red, SMD	LED_0603	LTST-C191KRKT	Lite-On
D6	1	Orange	LED, Orange, SMD	LED_0603	LTST-C191KFKT	Lite-On
H1, H2	2		Bumpon, Hemisphere, 0.44 X 0.20, Clear	Transparent Bumpon	SJ-5303 (CLEAR)	3M
J1	1		Connector, Plug, USB Type A, R/A, Top Mount SMT	USB Type A right angle	48037-1000	Molex
L1	1	220 ohm	Ferrite Bead, 220 ohm @ 100 MHz, 0.45 A, 0402	0402	BLM15AG221SN1D	MuRata
Q1, Q2, Q3, Q4, Q5, Q6, Q7, Q8	8	40 V	Transistor, NPN, 40 V, 0.2 A, 3-UFDFN	3-UFDFN	MMBT3904LP	Diodes Inc.
R1, R2, R3, R4, R5, R6, R7, R8	8	1.0k	RES, 1.0 k, 5%, 0.1 W, 0603	0603	RC0603JR-071KL	Yageo America
R9	1	0	RES, 0, 5%, 0.1 W, 0603	0603	CRCW06030000Z0EA	Vishay-Dale
R13	1	0	RES, 0, 5%, 0.063 W, 0402	0402	CRCW04020000Z0ED	Vishay-Dale
R14, R15, R16, R17	4	5.1k	RES, 5.1 k, 5%, 0.063 W, 0402	0402	CRCW04025K10JNED	Vishay-Dale
R18, R21	2	27	RES, 27, 5%, 0.063 W, 0402	0402	CRCW040227R0JNED	Vishay-Dale
R19	1	100k	RES, 100 k, 5%, 0.063 W, 0402	0402	CRCW0402100KJNED	Vishay-Dale
R20, R26, R28	3	1.0k	RES, 1.0 k, 5%, 0.063 W, 0402	0402	CRCW04021K00JNED	Vishay-Dale
R22	1	1.0Meg	RES, 1.0 M, 5%, 0.063 W, 0402	0402	CRCW04021M00JNED	Vishay-Dale

Table 4. EVM Bill of Materials (continued)

DESIGNATOR	QUANTITY	VALUE	DESCRIPTION	PACKAGE REFERENCE	PART NUMBER	MANUFACTURER
R23	1	1.5k	RES, 1.5 k, 5%, 0.063 W, 0402	0402	CRCW04021K50JNED	Vishay-Dale
R24	1	33	RES, 33, 5%, 0.063 W, 0402	0402	CRCW040233R0JNED	Vishay-Dale
R25	1	110	RES, 110, 5%, 0.063 W, 0402	0402	CRCW0402110RJNED	Vishay-Dale
R27	1	1.00k	RES, 1.00 k, 1%, 0.063 W, 0402	0402	CRCW04021K00FKED	Vishay-Dale
R29	1	33k	RES, 33 k, 5%, 0.063 W, 0402	0402	CRCW040233K0JNED	Vishay-Dale
S1	1		Switch, Slide, SPST, Top Slide, SMT	Switch, Single Top Slide, 2.5x8x2.5mm	CHS-01TB	Copal Electronics
SW1	1		Switch, SPST-NO, Off-Mom, 0.05A, 12VDC, SMD	3.9x2.9mm	PTS820 J20M SMTR LFS	C&K Components
U1	1		8-Channel High-Accuracy Remote and 1 Local Temperature Sensor with Pin-Programmable Bus Address, YFF0016AWAW	YFF0016AWAW or RGT0016C	TMP468AIYFFR or TMP468AIRGTR	Texas Instruments
U2, U6	2		Single Output LDO, 200 mA, Fixed 3.3 V Output, 2 to 5.5 V Input, with Low IQ, 5-pin SC70 (DCK), -40 to 125 degC, Green (RoHS & no Sb/Br)	DCK0005A	TLV70033DCKR	Texas Instruments
U3	1		ESD-Protection Array for High-Speed Data Interfaces, 4 Channels, -40 to +85 degC, 6-pin SON (DRY), Green (RoHS & no Sb/Br)	DRY0006A	TPD4E004DRYR	Texas Instruments
U4	1		Dual Inverter Gate, DCK0006A	DCK0006A	SN74LVC2G04DCKR	Texas Instruments
U5	1		25 MHz Mixed Signal Microcontroller with 128 KB Flash, 8192 B SRAM and 47 GPIOs, -40 to 85 degC, 64-pin QFN (RGC), Green (RoHS & no Sb/Br)	RGC0064B	MSP430F5528IRGCR	Texas Instruments
Y1	1		Resonator, 4MHz, 39pF SMD	4.5x1.2x2 mm	CSTCR4M00G15L99-R0	MuRata
FID1, FID2, FID3	0		Fiducial mark. There is nothing to buy or mount.	Fiducial	N/A	N/A
J2	0		Header, 2.54 mm, 3x1, Gold, TH	Header, 2.54 mm, 3x1, TH	GBC03SAAN	Sullins Connector Solutions
R10, R11, R12	0	0	RES, 0, 5%, 0.1 W, 0603	0603	CRCW06030000Z0EA	Vishay-Dale

Revision History

NOTE: Page numbers for previous revisions may differ from page numbers in the current version.

Changes from A Revision (February 2017) to B Revision	Page
• Changed the <i>EVM Software Setup</i> section. Renamed section to <i>TMP468EVM Software Installation</i>	7
• Changed the <i>Using the EVM Software</i> section. Renamed section to <i>Using the TMP468EVM Software</i>	12

Changes from Original (November 2016) to A Revision	Page
• Added TMP468QFNEVM to user's guide	1
• Added Figure 2, photo of TMP468QFNEVM	1
• Added Figure 20, layout for TMP468QFNEVM board	23

STANDARD TERMS FOR EVALUATION MODULES

1. *Delivery:* TI delivers TI evaluation boards, kits, or modules, including any accompanying demonstration software, components, and/or documentation which may be provided together or separately (collectively, an "EVM" or "EVMs") to the User ("User") in accordance with the terms set forth herein. User's acceptance of the EVM is expressly subject to the following terms.
 - 1.1 EVMs are intended solely for product or software developers for use in a research and development setting to facilitate feasibility evaluation, experimentation, or scientific analysis of TI semiconductors products. EVMs have no direct function and are not finished products. EVMs shall not be directly or indirectly assembled as a part or subassembly in any finished product. For clarification, any software or software tools provided with the EVM ("Software") shall not be subject to the terms and conditions set forth herein but rather shall be subject to the applicable terms that accompany such Software
 - 1.2 EVMs are not intended for consumer or household use. EVMs may not be sold, sublicensed, leased, rented, loaned, assigned, or otherwise distributed for commercial purposes by Users, in whole or in part, or used in any finished product or production system.
2. *Limited Warranty and Related Remedies/Disclaimers:*
 - 2.1 These terms do not apply to Software. The warranty, if any, for Software is covered in the applicable Software License Agreement.
 - 2.2 TI warrants that the TI EVM will conform to TI's published specifications for ninety (90) days after the date TI delivers such EVM to User. Notwithstanding the foregoing, TI shall not be liable for a nonconforming EVM if (a) the nonconformity was caused by neglect, misuse or mistreatment by an entity other than TI, including improper installation or testing, or for any EVMs that have been altered or modified in any way by an entity other than TI, (b) the nonconformity resulted from User's design, specifications or instructions for such EVMs or improper system design, or (c) User has not paid on time. Testing and other quality control techniques are used to the extent TI deems necessary. TI does not test all parameters of each EVM. User's claims against TI under this Section 2 are void if User fails to notify TI of any apparent defects in the EVMs within ten (10) business days after delivery, or of any hidden defects with ten (10) business days after the defect has been detected.
 - 2.3 TI's sole liability shall be at its option to repair or replace EVMs that fail to conform to the warranty set forth above, or credit User's account for such EVM. TI's liability under this warranty shall be limited to EVMs that are returned during the warranty period to the address designated by TI and that are determined by TI not to conform to such warranty. If TI elects to repair or replace such EVM, TI shall have a reasonable time to repair such EVM or provide replacements. Repaired EVMs shall be warranted for the remainder of the original warranty period. Replaced EVMs shall be warranted for a new full ninety (90) day warranty period.

WARNING

Evaluation Kits are intended solely for use by technically qualified, professional electronics experts who are familiar with the dangers and application risks associated with handling electrical mechanical components, systems, and subsystems.

User shall operate the Evaluation Kit within TI's recommended guidelines and any applicable legal or environmental requirements as well as reasonable and customary safeguards. Failure to set up and/or operate the Evaluation Kit within TI's recommended guidelines may result in personal injury or death or property damage. Proper set up entails following TI's instructions for electrical ratings of interface circuits such as input, output and electrical loads.

NOTE:

EXPOSURE TO ELECTROSTATIC DISCHARGE (ESD) MAY CAUSE DEGRADATION OR FAILURE OF THE EVALUATION KIT; TI RECOMMENDS STORAGE OF THE EVALUATION KIT IN A PROTECTIVE ESD BAG.

3 Regulatory Notices:

3.1 United States

3.1.1 Notice applicable to EVMs not FCC-Approved:

FCC NOTICE: This kit is designed to allow product developers to evaluate electronic components, circuitry, or software associated with the kit to determine whether to incorporate such items in a finished product and software developers to write software applications for use with the end product. This kit is not a finished product and when assembled may not be resold or otherwise marketed unless all required FCC equipment authorizations are first obtained. Operation is subject to the condition that this product not cause harmful interference to licensed radio stations and that this product accept harmful interference. Unless the assembled kit is designed to operate under part 15, part 18 or part 95 of this chapter, the operator of the kit must operate under the authority of an FCC license holder or must secure an experimental authorization under part 5 of this chapter.

3.1.2 For EVMs annotated as FCC – FEDERAL COMMUNICATIONS COMMISSION Part 15 Compliant:

CAUTION

This device complies with part 15 of the FCC Rules. Operation is subject to the following two conditions: (1) This device may not cause harmful interference, and (2) this device must accept any interference received, including interference that may cause undesired operation.

Changes or modifications not expressly approved by the party responsible for compliance could void the user's authority to operate the equipment.

FCC Interference Statement for Class A EVM devices

NOTE: This equipment has been tested and found to comply with the limits for a Class A digital device, pursuant to part 15 of the FCC Rules. These limits are designed to provide reasonable protection against harmful interference when the equipment is operated in a commercial environment. This equipment generates, uses, and can radiate radio frequency energy and, if not installed and used in accordance with the instruction manual, may cause harmful interference to radio communications. Operation of this equipment in a residential area is likely to cause harmful interference in which case the user will be required to correct the interference at his own expense.

FCC Interference Statement for Class B EVM devices

NOTE: This equipment has been tested and found to comply with the limits for a Class B digital device, pursuant to part 15 of the FCC Rules. These limits are designed to provide reasonable protection against harmful interference in a residential installation. This equipment generates, uses and can radiate radio frequency energy and, if not installed and used in accordance with the instructions, may cause harmful interference to radio communications. However, there is no guarantee that interference will not occur in a particular installation. If this equipment does cause harmful interference to radio or television reception, which can be determined by turning the equipment off and on, the user is encouraged to try to correct the interference by one or more of the following measures:

- Reorient or relocate the receiving antenna.
- Increase the separation between the equipment and receiver.
- Connect the equipment into an outlet on a circuit different from that to which the receiver is connected.
- Consult the dealer or an experienced radio/TV technician for help.

3.2 Canada

3.2.1 For EVMs issued with an Industry Canada Certificate of Conformance to RSS-210 or RSS-247

Concerning EVMs Including Radio Transmitters:

This device complies with Industry Canada license-exempt RSSs. Operation is subject to the following two conditions:

(1) this device may not cause interference, and (2) this device must accept any interference, including interference that may cause undesired operation of the device.

Concernant les EVMs avec appareils radio:

Le présent appareil est conforme aux CNR d'Industrie Canada applicables aux appareils radio exempts de licence. L'exploitation est autorisée aux deux conditions suivantes: (1) l'appareil ne doit pas produire de brouillage, et (2) l'utilisateur de l'appareil doit accepter tout brouillage radioélectrique subi, même si le brouillage est susceptible d'en compromettre le fonctionnement.

Concerning EVMs Including Detachable Antennas:

Under Industry Canada regulations, this radio transmitter may only operate using an antenna of a type and maximum (or lesser) gain approved for the transmitter by Industry Canada. To reduce potential radio interference to other users, the antenna type and its gain should be so chosen that the equivalent isotropically radiated power (e.i.r.p.) is not more than that necessary for successful communication. This radio transmitter has been approved by Industry Canada to operate with the antenna types listed in the user guide with the maximum permissible gain and required antenna impedance for each antenna type indicated. Antenna types not included in this list, having a gain greater than the maximum gain indicated for that type, are strictly prohibited for use with this device.

Concernant les EVMs avec antennes détachables

Conformément à la réglementation d'Industrie Canada, le présent émetteur radio peut fonctionner avec une antenne d'un type et d'un gain maximal (ou inférieur) approuvé pour l'émetteur par Industrie Canada. Dans le but de réduire les risques de brouillage radioélectrique à l'intention des autres utilisateurs, il faut choisir le type d'antenne et son gain de sorte que la puissance isotrope rayonnée équivalente (p.i.r.e.) ne dépasse pas l'intensité nécessaire à l'établissement d'une communication satisfaisante. Le présent émetteur radio a été approuvé par Industrie Canada pour fonctionner avec les types d'antenne énumérés dans le manuel d'usage et ayant un gain admissible maximal et l'impédance requise pour chaque type d'antenne. Les types d'antenne non inclus dans cette liste, ou dont le gain est supérieur au gain maximal indiqué, sont strictement interdits pour l'exploitation de l'émetteur.

3.3 Japan

3.3.1 *Notice for EVMs delivered in Japan:* Please see http://www.tij.co.jp/lstds/ti_ja/general/eStore/notice_01.page 日本国内に輸入される評価用キット、ボードについては、次のところをご覧ください。
http://www.tij.co.jp/lstds/ti_ja/general/eStore/notice_01.page

3.3.2 *Notice for Users of EVMs Considered "Radio Frequency Products" in Japan:* EVMs entering Japan may not be certified by TI as conforming to Technical Regulations of Radio Law of Japan.

If User uses EVMs in Japan, not certified to Technical Regulations of Radio Law of Japan, User is required to follow the instructions set forth by Radio Law of Japan, which includes, but is not limited to, the instructions below with respect to EVMs (which for the avoidance of doubt are stated strictly for convenience and should be verified by User):

1. Use EVMs in a shielded room or any other test facility as defined in the notification #173 issued by Ministry of Internal Affairs and Communications on March 28, 2006, based on Sub-section 1.1 of Article 6 of the Ministry's Rule for Enforcement of Radio Law of Japan,
2. Use EVMs only after User obtains the license of Test Radio Station as provided in Radio Law of Japan with respect to EVMs, or
3. Use of EVMs only after User obtains the Technical Regulations Conformity Certification as provided in Radio Law of Japan with respect to EVMs. Also, do not transfer EVMs, unless User gives the same notice above to the transferee. Please note that if User does not follow the instructions above, User will be subject to penalties of Radio Law of Japan.

【無線電波を送信する製品の開発キットをお使いになる際の注意事項】 開発キットの中には技術基準適合証明を受けていないものがあります。技術適合証明を受けていないものご使用に際しては、電波法遵守のため、以下のいずれかの措置を取っていただく必要がありますのでご注意ください。

1. 電波法施行規則第6条第1項第1号に基づく平成18年3月28日総務省告示第173号で定められた電波暗室等の試験設備でご使用いただく。
2. 実験局の免許を取得後ご使用いただく。
3. 技術基準適合証明を取得後ご使用いただく。

なお、本製品は、上記の「ご使用にあたっての注意」を譲渡先、移転先に通知しない限り、譲渡、移転できないものとします。

上記を遵守頂けない場合は、電波法の罰則が適用される可能性があることをご留意ください。日本テキサス・インスツルメンツ株式会社
東京都新宿区西新宿 6 丁目 2 4 番 1 号
西新宿三井ビル

3.3.3 *Notice for EVMs for Power Line Communication:* Please see http://www.tij.co.jp/lstds/ti_ja/general/eStore/notice_02.page
電力線搬送波通信についての開発キットをお使いになる際の注意事項については、次のところをご覧ください。http://www.tij.co.jp/lstds/ti_ja/general/eStore/notice_02.page

3.4 European Union

3.4.1 *For EVMs subject to EU Directive 2014/30/EU (Electromagnetic Compatibility Directive):*

This is a class A product intended for use in environments other than domestic environments that are connected to a low-voltage power-supply network that supplies buildings used for domestic purposes. In a domestic environment this product may cause radio interference in which case the user may be required to take adequate measures.

-
- 4 *EVM Use Restrictions and Warnings:*
- 4.1 EVMS ARE NOT FOR USE IN FUNCTIONAL SAFETY AND/OR SAFETY CRITICAL EVALUATIONS, INCLUDING BUT NOT LIMITED TO EVALUATIONS OF LIFE SUPPORT APPLICATIONS.
 - 4.2 User must read and apply the user guide and other available documentation provided by TI regarding the EVM prior to handling or using the EVM, including without limitation any warning or restriction notices. The notices contain important safety information related to, for example, temperatures and voltages.
 - 4.3 *Safety-Related Warnings and Restrictions:*
 - 4.3.1 User shall operate the EVM within TI's recommended specifications and environmental considerations stated in the user guide, other available documentation provided by TI, and any other applicable requirements and employ reasonable and customary safeguards. Exceeding the specified performance ratings and specifications (including but not limited to input and output voltage, current, power, and environmental ranges) for the EVM may cause personal injury or death, or property damage. If there are questions concerning performance ratings and specifications, User should contact a TI field representative prior to connecting interface electronics including input power and intended loads. Any loads applied outside of the specified output range may also result in unintended and/or inaccurate operation and/or possible permanent damage to the EVM and/or interface electronics. Please consult the EVM user guide prior to connecting any load to the EVM output. If there is uncertainty as to the load specification, please contact a TI field representative. During normal operation, even with the inputs and outputs kept within the specified allowable ranges, some circuit components may have elevated case temperatures. These components include but are not limited to linear regulators, switching transistors, pass transistors, current sense resistors, and heat sinks, which can be identified using the information in the associated documentation. When working with the EVM, please be aware that the EVM may become very warm.
 - 4.3.2 EVMs are intended solely for use by technically qualified, professional electronics experts who are familiar with the dangers and application risks associated with handling electrical mechanical components, systems, and subsystems. User assumes all responsibility and liability for proper and safe handling and use of the EVM by User or its employees, affiliates, contractors or designees. User assumes all responsibility and liability to ensure that any interfaces (electronic and/or mechanical) between the EVM and any human body are designed with suitable isolation and means to safely limit accessible leakage currents to minimize the risk of electrical shock hazard. User assumes all responsibility and liability for any improper or unsafe handling or use of the EVM by User or its employees, affiliates, contractors or designees.
 - 4.4 User assumes all responsibility and liability to determine whether the EVM is subject to any applicable international, federal, state, or local laws and regulations related to User's handling and use of the EVM and, if applicable, User assumes all responsibility and liability for compliance in all respects with such laws and regulations. User assumes all responsibility and liability for proper disposal and recycling of the EVM consistent with all applicable international, federal, state, and local requirements.
5. *Accuracy of Information:* To the extent TI provides information on the availability and function of EVMs, TI attempts to be as accurate as possible. However, TI does not warrant the accuracy of EVM descriptions, EVM availability or other information on its websites as accurate, complete, reliable, current, or error-free.
6. *Disclaimers:*
- 6.1 EXCEPT AS SET FORTH ABOVE, EVMS AND ANY MATERIALS PROVIDED WITH THE EVM (INCLUDING, BUT NOT LIMITED TO, REFERENCE DESIGNS AND THE DESIGN OF THE EVM ITSELF) ARE PROVIDED "AS IS" AND "WITH ALL FAULTS." TI DISCLAIMS ALL OTHER WARRANTIES, EXPRESS OR IMPLIED, REGARDING SUCH ITEMS, INCLUDING BUT NOT LIMITED TO ANY EPIDEMIC FAILURE WARRANTY OR IMPLIED WARRANTIES OF MERCHANTABILITY OR FITNESS FOR A PARTICULAR PURPOSE OR NON-INFRINGEMENT OF ANY THIRD PARTY PATENTS, COPYRIGHTS, TRADE SECRETS OR OTHER INTELLECTUAL PROPERTY RIGHTS.
 - 6.2 EXCEPT FOR THE LIMITED RIGHT TO USE THE EVM SET FORTH HEREIN, NOTHING IN THESE TERMS SHALL BE CONSTRUED AS GRANTING OR CONFERRING ANY RIGHTS BY LICENSE, PATENT, OR ANY OTHER INDUSTRIAL OR INTELLECTUAL PROPERTY RIGHT OF TI, ITS SUPPLIERS/LICENSORS OR ANY OTHER THIRD PARTY, TO USE THE EVM IN ANY FINISHED END-USER OR READY-TO-USE FINAL PRODUCT, OR FOR ANY INVENTION, DISCOVERY OR IMPROVEMENT, REGARDLESS OF WHEN MADE, CONCEIVED OR ACQUIRED.
7. *USER'S INDEMNITY OBLIGATIONS AND REPRESENTATIONS.* USER WILL DEFEND, INDEMNIFY AND HOLD TI, ITS LICENSORS AND THEIR REPRESENTATIVES HARMLESS FROM AND AGAINST ANY AND ALL CLAIMS, DAMAGES, LOSSES, EXPENSES, COSTS AND LIABILITIES (COLLECTIVELY, "CLAIMS") ARISING OUT OF OR IN CONNECTION WITH ANY HANDLING OR USE OF THE EVM THAT IS NOT IN ACCORDANCE WITH THESE TERMS. THIS OBLIGATION SHALL APPLY WHETHER CLAIMS ARISE UNDER STATUTE, REGULATION, OR THE LAW OF TORT, CONTRACT OR ANY OTHER LEGAL THEORY, AND EVEN IF THE EVM FAILS TO PERFORM AS DESCRIBED OR EXPECTED.

8. *Limitations on Damages and Liability:*

8.1 *General Limitations.* IN NO EVENT SHALL TI BE LIABLE FOR ANY SPECIAL, COLLATERAL, INDIRECT, PUNITIVE, INCIDENTAL, CONSEQUENTIAL, OR EXEMPLARY DAMAGES IN CONNECTION WITH OR ARISING OUT OF THESE TERMS OR THE USE OF THE EVMS , REGARDLESS OF WHETHER TI HAS BEEN ADVISED OF THE POSSIBILITY OF SUCH DAMAGES. EXCLUDED DAMAGES INCLUDE, BUT ARE NOT LIMITED TO, COST OF REMOVAL OR REINSTALLATION, ANCILLARY COSTS TO THE PROCUREMENT OF SUBSTITUTE GOODS OR SERVICES, RETESTING, OUTSIDE COMPUTER TIME, LABOR COSTS, LOSS OF GOODWILL, LOSS OF PROFITS, LOSS OF SAVINGS, LOSS OF USE, LOSS OF DATA, OR BUSINESS INTERRUPTION. NO CLAIM, SUIT OR ACTION SHALL BE BROUGHT AGAINST TI MORE THAN TWELVE (12) MONTHS AFTER THE EVENT THAT GAVE RISE TO THE CAUSE OF ACTION HAS OCCURRED.

8.2 *Specific Limitations.* IN NO EVENT SHALL TI'S AGGREGATE LIABILITY FROM ANY USE OF AN EVM PROVIDED HEREUNDER, INCLUDING FROM ANY WARRANTY, INDEMNITY OR OTHER OBLIGATION ARISING OUT OF OR IN CONNECTION WITH THESE TERMS, , EXCEED THE TOTAL AMOUNT PAID TO TI BY USER FOR THE PARTICULAR EVM(S) AT ISSUE DURING THE PRIOR TWELVE (12) MONTHS WITH RESPECT TO WHICH LOSSES OR DAMAGES ARE CLAIMED. THE EXISTENCE OF MORE THAN ONE CLAIM SHALL NOT ENLARGE OR EXTEND THIS LIMIT.

9. *Return Policy.* Except as otherwise provided, TI does not offer any refunds, returns, or exchanges. Furthermore, no return of EVM(s) will be accepted if the package has been opened and no return of the EVM(s) will be accepted if they are damaged or otherwise not in a resalable condition. If User feels it has been incorrectly charged for the EVM(s) it ordered or that delivery violates the applicable order, User should contact TI. All refunds will be made in full within thirty (30) working days from the return of the components(s), excluding any postage or packaging costs.

10. *Governing Law:* These terms and conditions shall be governed by and interpreted in accordance with the laws of the State of Texas, without reference to conflict-of-laws principles. User agrees that non-exclusive jurisdiction for any dispute arising out of or relating to these terms and conditions lies within courts located in the State of Texas and consents to venue in Dallas County, Texas. Notwithstanding the foregoing, any judgment may be enforced in any United States or foreign court, and TI may seek injunctive relief in any United States or foreign court.

Mailing Address: Texas Instruments, Post Office Box 655303, Dallas, Texas 75265
Copyright © 2019, Texas Instruments Incorporated

IMPORTANT NOTICE AND DISCLAIMER

TI PROVIDES TECHNICAL AND RELIABILITY DATA (INCLUDING DATASHEETS), DESIGN RESOURCES (INCLUDING REFERENCE DESIGNS), APPLICATION OR OTHER DESIGN ADVICE, WEB TOOLS, SAFETY INFORMATION, AND OTHER RESOURCES "AS IS" AND WITH ALL FAULTS, AND DISCLAIMS ALL WARRANTIES, EXPRESS AND IMPLIED, INCLUDING WITHOUT LIMITATION ANY IMPLIED WARRANTIES OF MERCHANTABILITY, FITNESS FOR A PARTICULAR PURPOSE OR NON-INFRINGEMENT OF THIRD PARTY INTELLECTUAL PROPERTY RIGHTS.

These resources are intended for skilled developers designing with TI products. You are solely responsible for (1) selecting the appropriate TI products for your application, (2) designing, validating and testing your application, and (3) ensuring your application meets applicable standards, and any other safety, security, or other requirements. These resources are subject to change without notice. TI grants you permission to use these resources only for development of an application that uses the TI products described in the resource. Other reproduction and display of these resources is prohibited. No license is granted to any other TI intellectual property right or to any third party intellectual property right. TI disclaims responsibility for, and you will fully indemnify TI and its representatives against, any claims, damages, costs, losses, and liabilities arising out of your use of these resources.

TI's products are provided subject to TI's Terms of Sale (www.ti.com/legal/termsofsale.html) or other applicable terms available either on ti.com or provided in conjunction with such TI products. TI's provision of these resources does not expand or otherwise alter TI's applicable warranties or warranty disclaimers for TI products.

Mailing Address: Texas Instruments, Post Office Box 655303, Dallas, Texas 75265
Copyright © 2019, Texas Instruments Incorporated