

## Rochester Electronics Manufactured Components

Rochester branded components are manufactured using either die/wafers purchased from the original suppliers or Rochester wafers recreated from the original IP. All recreations are done with the approval of the OCM.

Parts are tested using original factory test programs or Rochester developed test solutions to guarantee product meets or exceed the OCM data sheet.

## Quality Overview

- ISO-9001
- AS9120 certification
- Qualified Manufacturers List (QML) MIL-PRF-35835
  - Class Q Military
  - Class V Space Level
- Qualified Suppliers List of Distributors (QSLD)
  - Rochester is a critical supplier to DLA and meets all industry and DLA standards.

Rochester Electronics, LLC is committed to supplying products that satisfy customer expectations for quality and are equal to those originally supplied by industry manufacturers.

The original manufacturer's datasheet accompanying this document reflects the performance and specifications of the Rochester manufactured version of this device. Rochester Electronics guarantees the performance of its semiconductor products to the original OEM specifications. 'Typical' values are for reference purposes only. Certain minimum or maximum ratings may be based on product characterization, design, simulation, or sample testing.

# TLV2217-33, TLV2217-33Y LOW-DROPOUT 3.3-V FIXED-VOLTAGE REGULATORS

SLVS067F – MARCH 1992 – REVISED AUGUST 1998

- Fixed 3.3-V Output
- $\pm 1\%$  Maximum Output Voltage Tolerance at  $T_J = 25^\circ\text{C}$
- 500-mV Maximum Dropout Voltage at 500 mA
- 500-mA Dropout Current
- $\pm 2\%$  Absolute Output Voltage Variation
- Internal Overcurrent Limiting
- Internal Thermal-Overload Protection
- Internal Overvoltage Protection
- Package Options Include Plastic Flange Mounted (KTP), Power (KC), and Thin Shrink Small-Outline (PW) Packages, and Ceramic Chip Carriers (FK) and DIPs (J)

## description

The TLV2217-33 is a low-dropout 3.3-V fixed-voltage regulator. The regulator is capable of sourcing 500 mA of current with an input-output differential of 0.5 V or less. The TLV2217-33 provides internal overcurrent limiting, thermal-overload protection, and overvoltage protection.

The 0.5-V dropout for the TLV2217-33 makes it ideal for battery applications in 3.3-V logic systems. For example, battery input voltage to the regulator can drop as low as 3.8 V, and the TLV2217-33 can continue to regulate the system. For higher voltage systems, the TLV2217-33 can be operated with a continuous input voltage of 12 V.

The TLV2217-33 regulators are characterized for operation from  $0^\circ\text{C}$  to  $125^\circ\text{C}$  virtual junction temperature.

The TLV2217-33M regulators are characterized for operation over the full military virtual junction temperature range of  $-55^\circ\text{C}$  to  $125^\circ\text{C}$ .

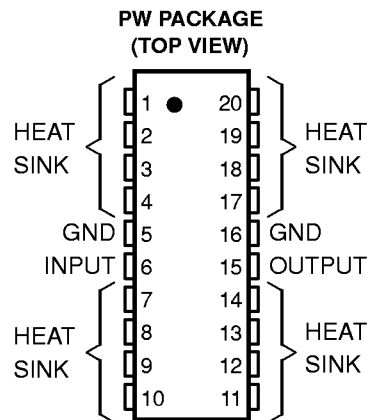

HEAT SINK – These terminals have an internal resistive connection to ground and should be grounded or electrically isolated.

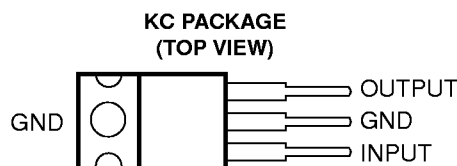

The GND terminal is in electrical contact with the mounting base.

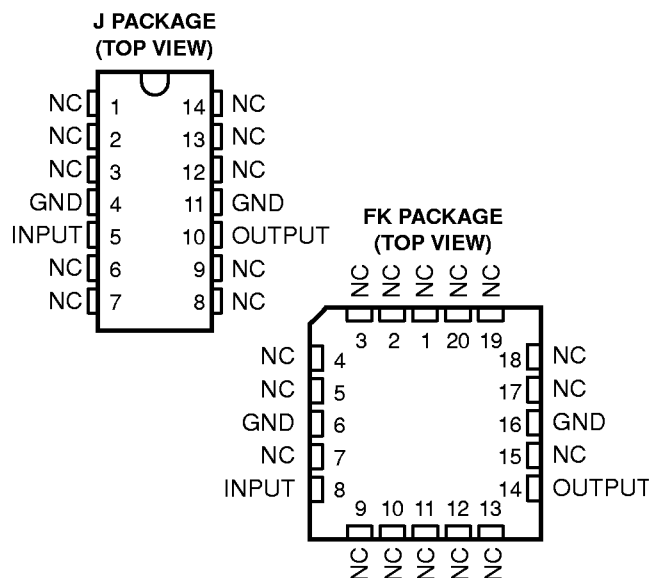

NC – No internal connection

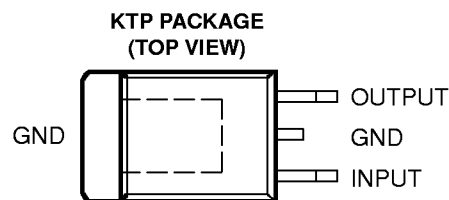

The GND terminal is in electrical contact with the mounting base.



Please be aware that an important notice concerning availability, standard warranty, and use in critical applications of Texas Instruments semiconductor products and disclaimers thereto appears at the end of this data sheet.

PRODUCTION DATA information is current as of publication date. Products conform to specifications per the terms of Texas Instruments standard warranty. Production processing does not necessarily include testing of all parameters.

**TEXAS  
INSTRUMENTS**

POST OFFICE BOX 655303 • DALLAS, TEXAS 75265

Copyright © 1998, Texas Instruments Incorporated

# TLV2217-33, TLV2217-33Y LOW-DROPOUT 3.3-V FIXED-VOLTAGE REGULATORS

SLVS067F – MARCH 1992 – REVISED AUGUST 1998

## application schematic

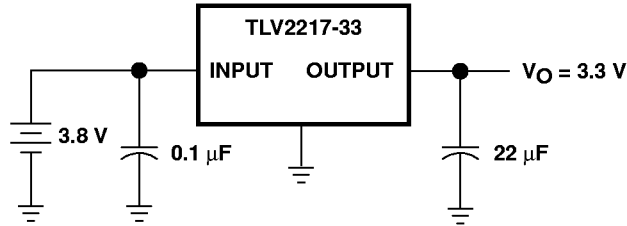

### AVAILABLE OPTIONS

T <sub>J</sub>	PACKAGED DEVICES					CHIP FORM (Y)
	CHIP CARRIER (FK)	CERAMIC DIP (J)	PLASTIC POWER (KC)	SURFACE MOUNT (PW) <sup>†</sup>	PLASTIC FLANGE MOUNT (KTP) <sup>†</sup>	
0°C to 125°C	—	—	TLV2217-33KC	TLV2217-33PWR	TLV2217-33KTPR	TLV2217-33Y
-55°C to 125°C	TLV2217-33MFKB	TLV2217-33MJB	—	—	—	

<sup>†</sup> The KTP and PW packages are available left-end taped and reeled only.

# TLV2217-33, TLV2217-33Y LOW-DROPOUT 3.3-V FIXED-VOLTAGE REGULATORS

SLVS067F – MARCH 1992 – REVISED AUGUST 1998

## TLV2217-33Y chip information

These chips, when properly assembled, display characteristics similar to the TLV2217-33 (see electrical tables). Thermal compression or ultrasonic bonding can be used on the doped aluminum bonding pads. The chip can be mounted with conductive epoxy or a gold-silicon preform.

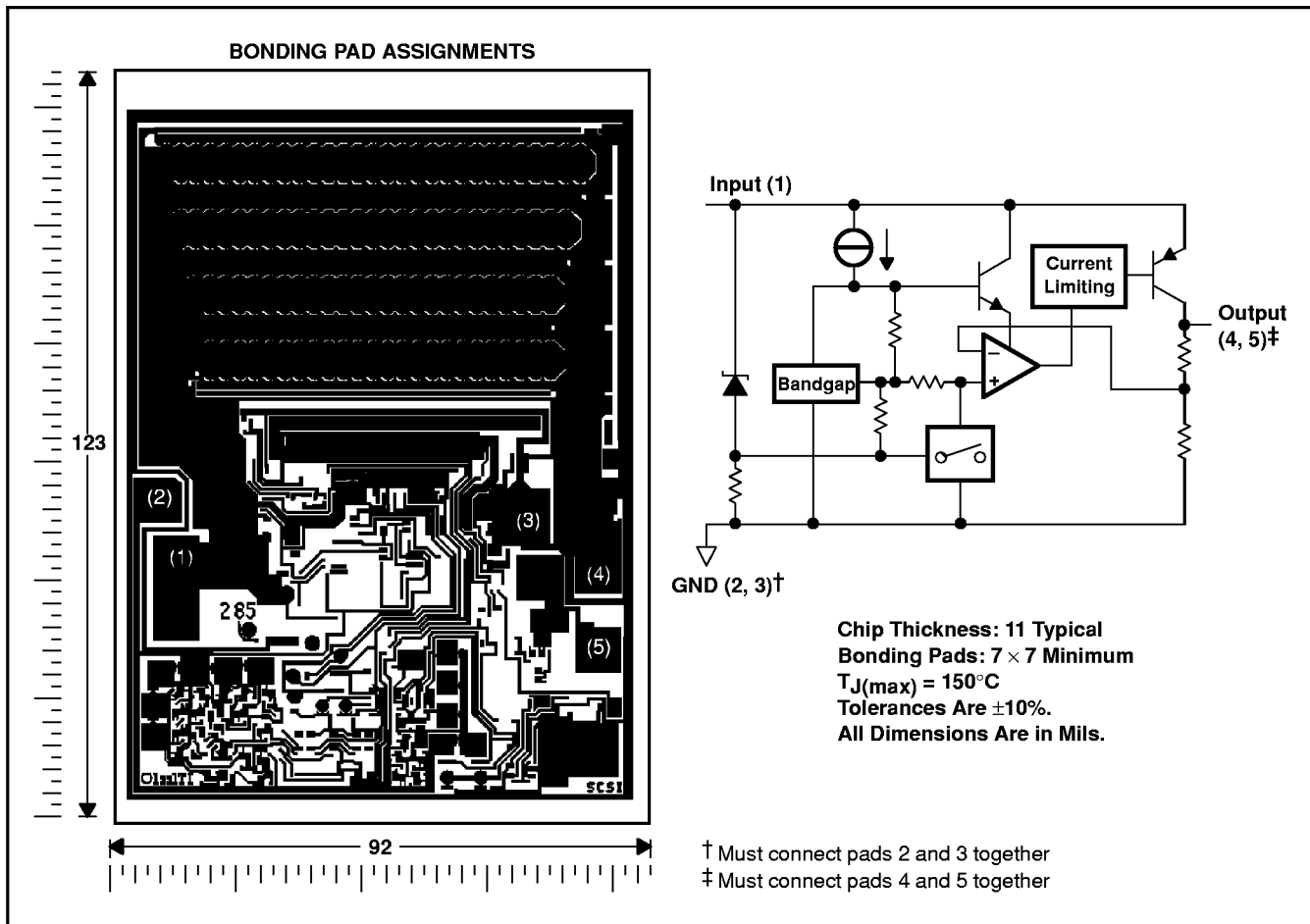



# TLV2217-33, TLV2217-33Y LOW-DROPOUT 3.3-V FIXED-VOLTAGE REGULATORS

SLVS067F – MARCH 1992 – REVISED AUGUST 1998

## TLV2217-33 recommended operating conditions

	TLV2217-33		UNIT
	MIN	MAX	
Input voltage, $V_I$	3.8	12	V
Output current, $I_O$	0	500	mA
Operating virtual junction temperature range, $T_J$	0	125	°C

## TLV2217-33M recommended operating conditions

		TLV2217-33M		UNIT
		MIN	MAX	
Input voltage, $V_I$	$T_J = 25^\circ\text{C}$	3.8	12	V
	$T_J = -55^\circ\text{C to } 125^\circ\text{C}$	3.9	12	
Output current, $I_O$		0	480	mA
Operating virtual junction temperature range, $T_J$		-55	125	°C

## electrical characteristics at $V_I = 4.5\text{ V}$ , $I_O = 500\text{ mA}$ , $T_J = 25^\circ\text{C}$ (unless otherwise noted)

PARAMETER	TEST CONDITION <sup>†</sup>	TLV2217-33			UNIT	
		MIN	TYP	MAX		
Output voltage	$I_O = 20\text{ mA to } 500\text{ mA}$ , $V_I = 3.8\text{ V to } 5.5\text{ V}$	$T_J = 25^\circ\text{C}$	3.267	3.30	3.333	V
		$T_J = 0^\circ\text{C to } 125^\circ\text{C}$	3.234		3.366	
Input voltage regulation	$V_I = 3.8\text{ V to } 5.5\text{ V}$		5	15	mV	
Ripple rejection	$f = 120\text{ Hz}$ , $V_{\text{ripple}} = 1\text{ V}_{\text{PP}}$		-62		dB	
Output voltage regulation	$I_O = 20\text{ mA to } 500\text{ mA}$		5	30	mV	
Output noise voltage	$f = 10\text{ Hz to } 100\text{ kHz}$		500		$\mu\text{V}$	
Dropout voltage	$I_O = 250\text{ mA}$			400	mV	
	$I_O = 500\text{ mA}$			500		
Bias current	$I_O = 0$		2	5	mA	
	$I_O = 500\text{ mA}$		19	49		

<sup>†</sup> Pulse-testing techniques are used to maintain the virtual junction temperature as close to the ambient temperature as possible. Thermal effects must be taken into account separately. All characteristics are measured with a 0.1- $\mu\text{F}$  capacitor across the input and a 22- $\mu\text{F}$  tantalum capacitor with equivalent series resistance of 1.5  $\Omega$  on the output.



# TLV2217-33, TLV2217-33Y

## LOW-DROPOUT 3.3-V FIXED-VOLTAGE REGULATORS

SLVS067F – MARCH 1992 – REVISED AUGUST 1998

### electrical characteristics at $V_I = 4.5\text{ V}$ , $I_O = 500\text{ mA}$ , $T_J = 25^\circ\text{C}$ (unless otherwise noted)

PARAMETER	TEST CONDITIONS†		TLV2217-33M			UNIT
			MIN	TYP	MAX	
Output voltage	$I_O = 20\text{ mA to }480\text{ mA}$	$V_I = 3.8\text{ V to }5.5\text{ V}$ , $T_J = 25^\circ$	3.267	3.3	3.333	V
		$V_I = 3.9\text{ V to }5.5\text{ V}$	3.234 3.366			
Input voltage regulation	$V_I = 3.8\text{ V to }5.5\text{ V}$ ,	$T_J = 25^\circ\text{C}$	15			mV
Ripple rejection	$f = 120\text{ Hz}$ ,	$V_{\text{ripple}} = 1\text{ V}_{\text{PP}}$	-62			dB
Output voltage regulation	$I_O = 20\text{ mA to }480\text{ mA}$ ,	$T_J = 25^\circ\text{C}$	30			mV
Output noise voltage	$f = 10\text{ Hz to }100\text{ kHz}$		500			$\mu\text{V}$
Dropout voltage	$I_O = 250\text{ mA}$		400			mV
	$I_O = 480\text{ mA}$ ,	$T_J = 25^\circ\text{C}$	500			
	$I_O = 480\text{ mA}$		550			
Bias current	$I_O = 0$		5			mA
	$I_O = 480\text{ mA}$		49			

† Pulse-testing techniques are used to maintain the virtual junction temperature as close to the ambient temperature as possible. Thermal effects must be taken into account separately. All characteristics are measured with a  $0.1\text{-}\mu\text{F}$  capacitor across the input and a  $22\text{-}\mu\text{F}$  tantalum capacitor with equivalent series resistance of  $1.5\ \Omega$  on the output.

### electrical characteristics at $V_I = 4.5\text{ V}$ , $I_O = 500\text{ mA}$ , $T_J = 25^\circ\text{C}$ (unless otherwise noted)

PARAMETER	TEST CONDITIONS†		TLV2217-33Y			UNIT
			MIN	TYP	MAX	
Output voltage	$I_O = 20\text{ mA to }500\text{ mA}$ ,	$V_I = 3.8\text{ V to }5.5\text{ V}$	3.267	3.30	3.333	V
Input voltage regulation	$V_I = 3.8\text{ V to }5.5\text{ V}$		5 15			mV
Ripple rejection	$f = 120\text{ Hz}$ ,	$V_{\text{ripple}} = 1\text{ V}_{\text{PP}}$	-62			dB
Output voltage regulation	$I_O = 20\text{ mA to }500\text{ mA}$		5 30			mV
Output noise voltage	$f = 10\text{ Hz to }100\text{ kHz}$		500			$\mu\text{V}$
Dropout voltage	$I_O = 250\text{ mA}$		400			mV
	$I_O = 500\text{ mA}$		500			
Bias current	$I_O = 0$		2 5			mA
	$I_O = 500\text{ mA}$		19 49			

† Pulse-testing techniques are used to maintain the virtual junction temperature as close to the ambient temperature as possible. Thermal effects must be taken into account separately. All characteristics are measured with a  $0.1\text{-}\mu\text{F}$  capacitor across the input and a  $22\text{-}\mu\text{F}$  tantalum capacitor with equivalent series resistance of  $1.5\ \Omega$  on the output.



COMPENSATION CAPACITOR SELECTION INFORMATION

The TLV2217-33 is a low-dropout regulator. This means that the capacitance loading is important to the performance of the regulator because it is a vital part of the control loop. The capacitor value and the equivalent series resistance (ESR) both affect the control loop and must be defined for the load range and the temperature range. Figures 3 and 4 can be used to establish the capacitance value and ESR range for best regulator performance.

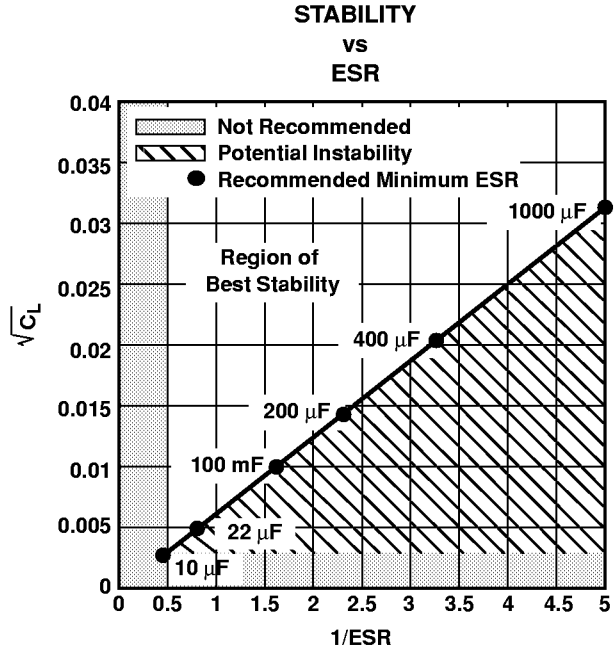
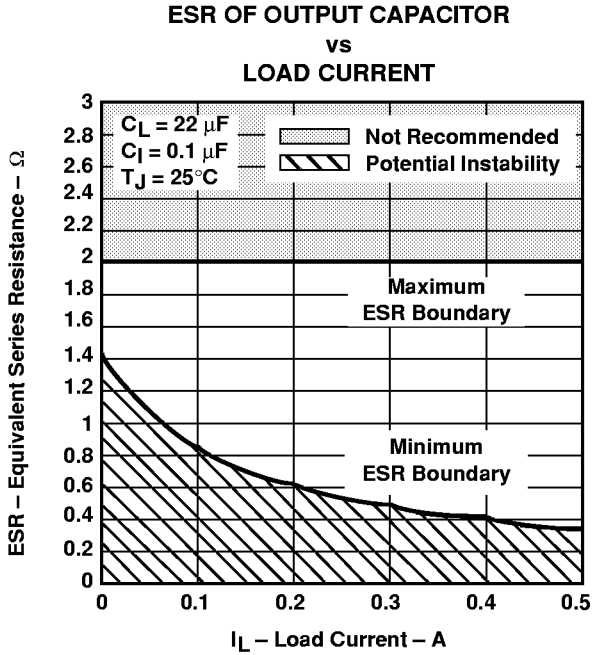

Figure 4

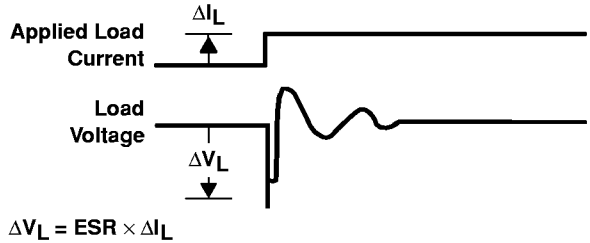

Figure 3



## **IMPORTANT NOTICE**

Texas Instruments and its subsidiaries (TI) reserve the right to make changes to their products or to discontinue any product or service without notice, and advise customers to obtain the latest version of relevant information to verify, before placing orders, that information being relied on is current and complete. All products are sold subject to the terms and conditions of sale supplied at the time of order acknowledgement, including those pertaining to warranty, patent infringement, and limitation of liability.

TI warrants performance of its semiconductor products to the specifications applicable at the time of sale in accordance with TI's standard warranty. Testing and other quality control techniques are utilized to the extent TI deems necessary to support this warranty. Specific testing of all parameters of each device is not necessarily performed, except those mandated by government requirements.

**CERTAIN APPLICATIONS USING SEMICONDUCTOR PRODUCTS MAY INVOLVE POTENTIAL RISKS OF DEATH, PERSONAL INJURY, OR SEVERE PROPERTY OR ENVIRONMENTAL DAMAGE ("CRITICAL APPLICATIONS"). TI SEMICONDUCTOR PRODUCTS ARE NOT DESIGNED, AUTHORIZED, OR WARRANTED TO BE SUITABLE FOR USE IN LIFE-SUPPORT DEVICES OR SYSTEMS OR OTHER CRITICAL APPLICATIONS. INCLUSION OF TI PRODUCTS IN SUCH APPLICATIONS IS UNDERSTOOD TO BE FULLY AT THE CUSTOMER'S RISK.**

In order to minimize risks associated with the customer's applications, adequate design and operating safeguards must be provided by the customer to minimize inherent or procedural hazards.

TI assumes no liability for applications assistance or customer product design. TI does not warrant or represent that any license, either express or implied, is granted under any patent right, copyright, mask work right, or other intellectual property right of TI covering or relating to any combination, machine, or process in which such semiconductor products or services might be or are used. TI's publication of information regarding any third party's products or services does not constitute TI's approval, warranty or endorsement thereof.