

1-776266-1 ✓ ACTIVE

AMP | AMPSEAL

TE Internal #: 1-776266-1

PCB Mount Header, Right Angle, Wire-to-Board, 14 Position, 4 mm [.157 in] Centerline, Fully Shrouded, Gold, Through Hole - Solder, Sealable, AMPSEAL

[View on TE.com >](#)



Connectors > PCB Connectors > PCB Headers & Receptacles > AMPSEAL PCB Horizontal Headers

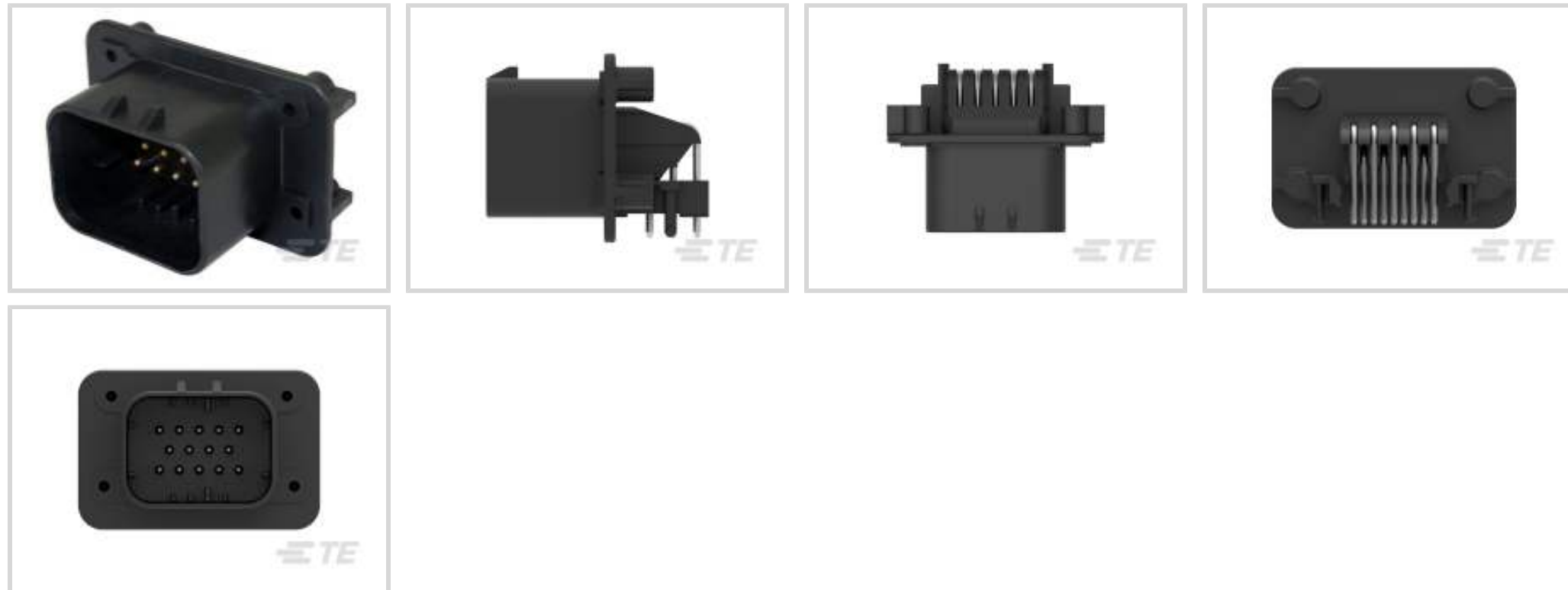

Connector System: **Wire-to-Board**

Number of Positions: **14**

Centerline (Pitch): **4 mm [ .157 in ]**

Sealable: **Yes**

PCB Mount Orientation: **Right Angle**

[All AMPSEAL PCB Horizontal Headers \(55\)](#)

## Features

### Product Type Features

PCB Connector Assembly Type	PCB Mount Header
Header Type	Fully Shrouded
Connector System	Wire-to-Board
Sealable	Yes
Connector & Contact Terminates To	Printed Circuit Board

### Configuration Features

Number of Positions	14
PCB Mount Orientation	Right Angle
Number of Rows	3

### Body Features

Primary Product Color	Black
-----------------------	-------

### Contact Features



Contact Type	Pin
Contact Mating Area Plating Material	Gold
Contact Current Rating (Max)	17 A

#### Termination Features

Termination Method to Printed Circuit Board	Through Hole - Solder
---	-----------------------

#### Mechanical Attachment

Mating Alignment	With
PCB Mount Alignment	With
PCB Mount Retention	With
Connector Mounting Type	Fixing Screw

#### Housing Features

Centerline (Pitch)	4 mm [.157 in]
--------------------	----------------

#### Usage Conditions

Operating Temperature Range	-40 – 125 °C [-40 – 257 °F]
-----------------------------	-----------------------------

#### Operation/Application

Circuit Application	Power & Signal
---------------------	----------------

#### Industry Standards

UL Flammability Rating	UL 94V-0
------------------------	----------

#### Packaging Features

Packaging Type	Tray
----------------	------

#### Product Compliance

[For compliance documentation, visit the product page on TE.com>](#)

EU RoHS Directive 2011/65/EU	Compliant
EU ELV Directive 2000/53/EC	Compliant
China RoHS 2 Directive MIIT Order No 32, 2016	No Restricted Materials Above Threshold
EU REACH Regulation (EC) No. 1907/2006	Current ECHA Candidate List: JUNE 2023 (235) Candidate List Declared Against: JUNE 2023 (235) Does not contain REACH SVHC
Halogen Content	Not Low Halogen - contains Br or Cl > 900 ppm.
Solder Process Capability	Wave solder capable to 265°C

Product Compliance Disclaimer

This information is provided based on reasonable inquiry of our suppliers and represents our current actual knowledge based on the information they provided. This information is subject to change. The part numbers that TE has identified as EU RoHS compliant have a maximum concentration of 0.1% by weight in homogenous materials for lead, hexavalent chromium, mercury, PBB, PBDE, DBP, BBP, DEHP, DIBP, and 0.01% for cadmium, or qualify for an exemption to these limits as defined in the Annexes of Directive 2011/65/EU (RoHS2). Finished electrical and electronic equipment products will be CE marked as required by Directive 2011/65/EU. Components may not be CE marked. Additionally, the part numbers that TE has identified as EU ELV compliant have a maximum concentration of 0.1% by weight in homogenous materials for lead, hexavalent chromium, and mercury, and 0.01% for cadmium, or qualify for an exemption to these limits as defined in the Annexes of Directive 2000/53/EC (ELV). Regarding the REACH Regulation, the information TE provides on SVHC in articles for this part number is based on the latest European Chemicals Agency (ECHA) 'Guidance on requirements for substances in articles' posted at this URL: <https://echa.europa.eu/guidance-documents/guidance-on-reach>

## Compatible Parts



## Also in the Series | AMPSEAL

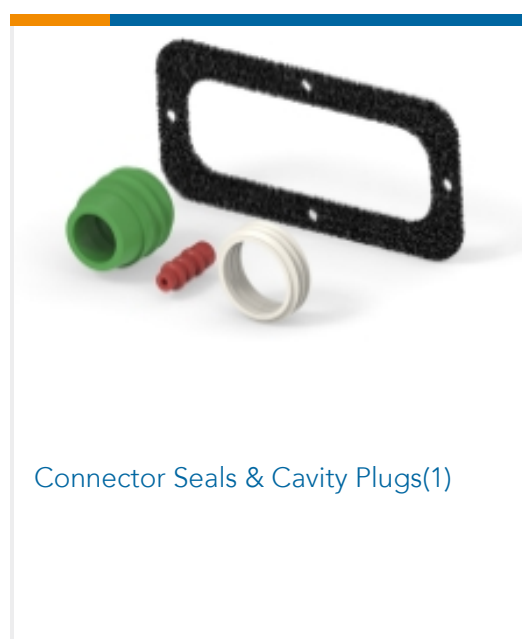
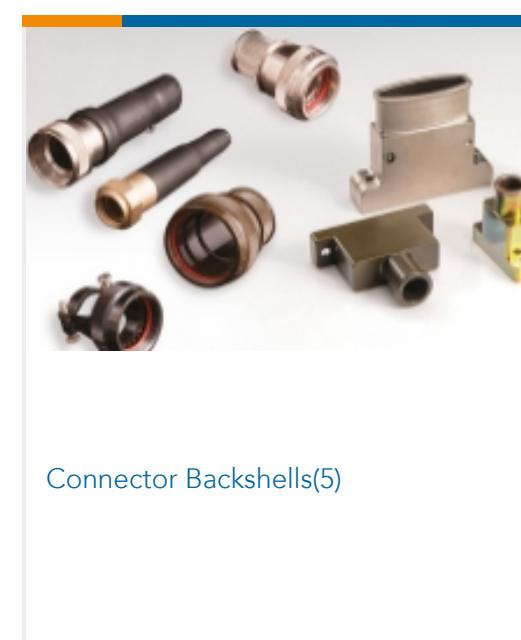
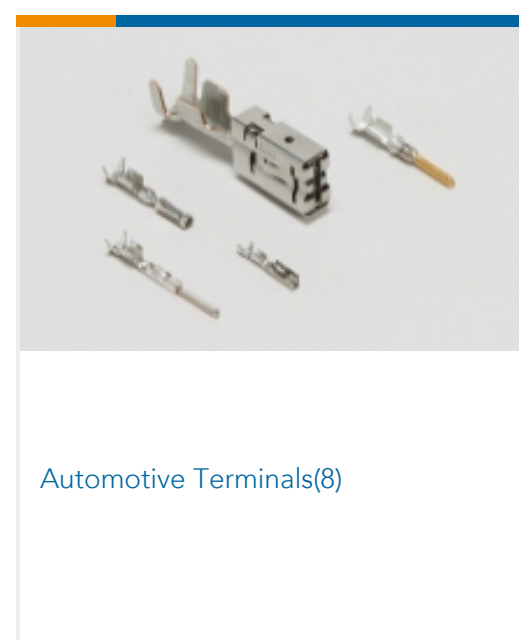
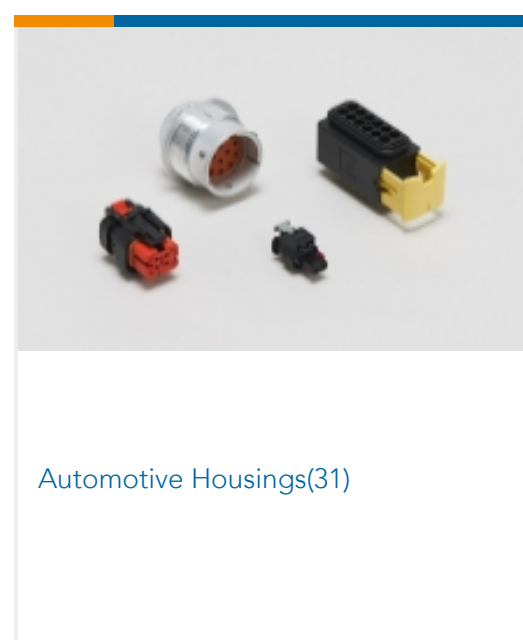

## Customers Also Bought



TE Part #640454-8  
08P MTA100 HDR ASSY SQ STR POL



TE Part #3-2176057-3  
RLP73K 3A R22 1% 1K RL



TE Part #2106431-2  
Connector, SMT-IDC PASS THRU, 2  
POS, 18

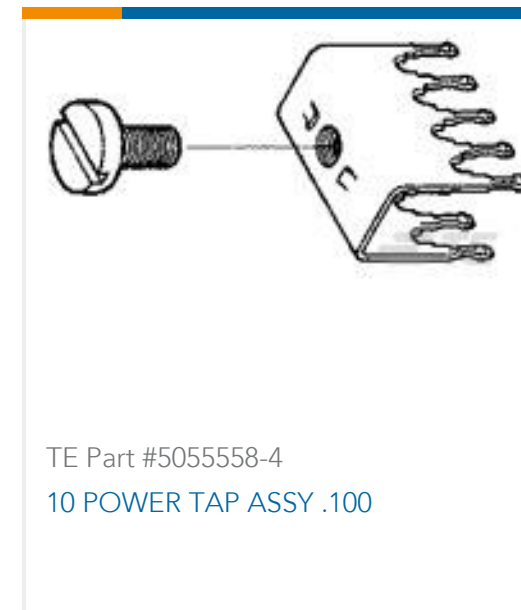

TE Part #5055558-4  
10 POWER TAP ASSY .100



TE Part #DRC13-70PD-B027  
HDR, 70P, BLK, RA, M5, FLG, NI/CU, D



TE Part #1-215297-4  
14P HV100 REC CON. TE, 7.0MM

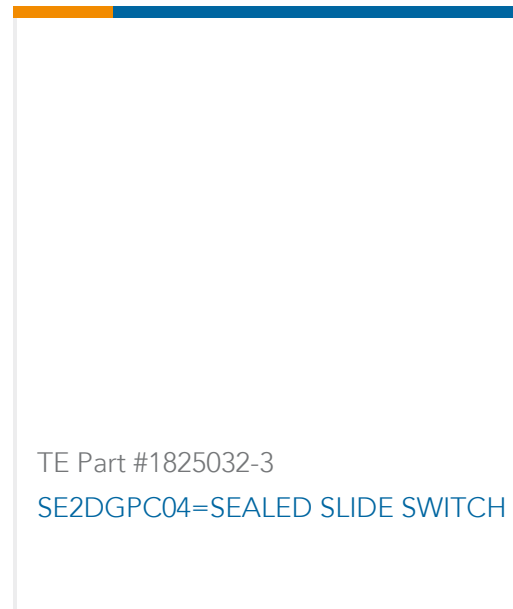

TE Part #1825032-3  
SE2DGPC04=SEALED SLIDE SWITCH

## Documents

### Product Drawings

14POS,PIN DIA 1.3,HDR ASSY,90DEG,COD 1

English

### CAD Files

Customer View Model

[ENG\\_CVM\\_CVM\\_1-776266-1\\_B.2d\\_dxf.zip](#)

English

3D PDF

3D

Customer View Model

[ENG\\_CVM\\_CVM\\_1-776266-1\\_B.3d\\_igs.zip](#)

English

Customer View Model

[ENG\\_CVM\\_CVM\\_1-776266-1\\_B.3d\\_stp.zip](#)

English

By downloading the CAD file I accept and agree to the [Terms and Conditions](#) of use.

### Datasheets & Catalog Pages

[AMPSEAL Connector Catalog](#)

English

[ICT Terminals and Connectors Catalogue](#)

English

[CONNECTOR SELECTOR](#)

English

### Product Specifications



### Application Specification

English

---

### Agency Approvals

UL Report

English