

# E510

THE NEW VISION OF TOUCH™

QWheel™

QUANTUM  
RESEARCH GROUP

User Manual

QWheel™

# E510

## User Manual



### OVERVIEW

This kit is designed for evaluation and development of QT510-based QWheel™ Rotary slider. It includes a fully assembled rotary slider evaluation board, user panel, cables and software. The E510 has a serial interface allowing connection to a PC for control and data viewing via an included USB to SPI adapter and PC software.

*For more detailed information about this product please refer to the QT510 datasheet.*

#### Materials Provided:

- 1 x White plastic user panel
- 1 x E510 evaluation board with self-adhesive on one side
- 4 x Rubber feet
- 1 x USB-PC cable
- 1 x USB-SPI adapter with USB-SPI cable to the E510
- 1 x SPI cable for user connection to a microcontroller
- 2 x Sample QT510 ICs
- 1 x CD-ROM with QSlide™ software and USB drivers
- 1 x User Guide

## BOARD PREPARATION

3

The E510 eval board can be adhered to plastic, glass, or any other dielectric panel. If you wish to use the supplied user panel, please follow the steps below:

- 1 Use normal ESD precautions when working with the E510!!
- 2 Place the user panel face down on a table-  
Tape down the edges of the panel so it cannot move while you work with it.



- 3 Remove the paper backing from the E510 Board and adhere it to the rear of the user panel. Bend the PCB slightly as shown while smoothing it to remove any air bubbles.

*Tip: Line up the PCB with the alignment marks on the back of the slider panel. **The PCB must be positioned with the connector on the underside of the QWheel™ logo.** The Board does allow some flexing, but care must be taken not to bend it too far as this will crack the solder joints.*



- 4 Un tape the user panel from the table and mount the four rubber feet as shown to make the E510 mechanically stable in use.



To Run the E510, Please Follow These Steps:

- 1 **IMPORTANT:** First install QSlide™ software and USB drivers (see page 10).
- 2 Make sure the USB adapter box is NOT plugged into your PC at this time.
- 3 Connect the E510 to the USB box with the red USB-SPI cable
- 4 Connect the USB adapter to your running PC and wait at least 10 seconds for the USB adaptor to be recognized. The LED on the USB box should illuminate permanently.
- 5 Run the QSlide™ software ([Qslide\\_V\[x\].exe](#)) which should be on your desktop or other location where you copied it. **See next page for details of Qslide software operation.**
- 6 With your hands far removed from the E510: Click on the FIXED CAL.
- 7 Slowly move your hand towards the rotor area. The proximity detection status box will indicate when your hand is still several cm away from the panel.
- 8 Touch the rotor area with a finger. You can either slide your finger around the surface or touch the rotor at any point. When you remove your finger, the last position touched will be locked on the display.

**Things to Try:**

— Alter the proximity and detection thresholds using the pull down menus to change the sensitivity to proximity and touch. The higher the threshold, the less sensitive the E510 will become.

# QSLIDE™ SOFTWARE OPERATION 5

**Warning:** Disconnecting the USB cable from the PC while QSlide software is communicating with the E510 board may crash the software. Please close the QSlide software before unplugging the USB cable.

QSlide software should automatically detect the correct com port; if not, you may need to select the port manually as shown in the picture.

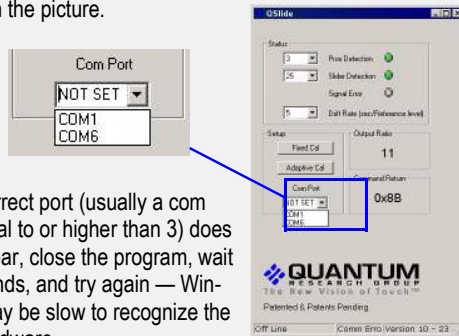

If the correct port (usually a com port equal to or higher than 3) does not appear, close the program, wait 30 seconds, and try again — Windows may be slow to recognize the USB hardware.

### QSlide settings

When starting QSlide software the previous values of Prox detection, Slider detection and drift rate are loaded. It may be necessary to reset to the default values shown on the next page.

Signal Error indicates that the signal has the wrong polarity, usually due to movement of the board. Clicking the **Fixed Cal** button will resolve the problem.

**Drift Rate** sets the adaptive drift compensation rate; the numbers represent seconds per compensation. Default = 5

Calibration should be performed with the board mounted securely in its intended position and operating environment, and hands at a distance. Once positioned it should be calibrated using the **Fixed Cal** button. *If the board is moved it may need to be re-calibrated. If any status flags are set prior to operation then the calibration should be repeated.*

**Prox Detection** indicates that the board has detected hand at a distance. The Prox value sets the threshold which will cause the chip to register proximity. Lower numbers are more sensitive. Default = 3

**Slider Detection** indicates that the board is detecting a finger touch. Changing the associated threshold sets the minimum signal change which will cause the board to register a touch detection. Default = 25

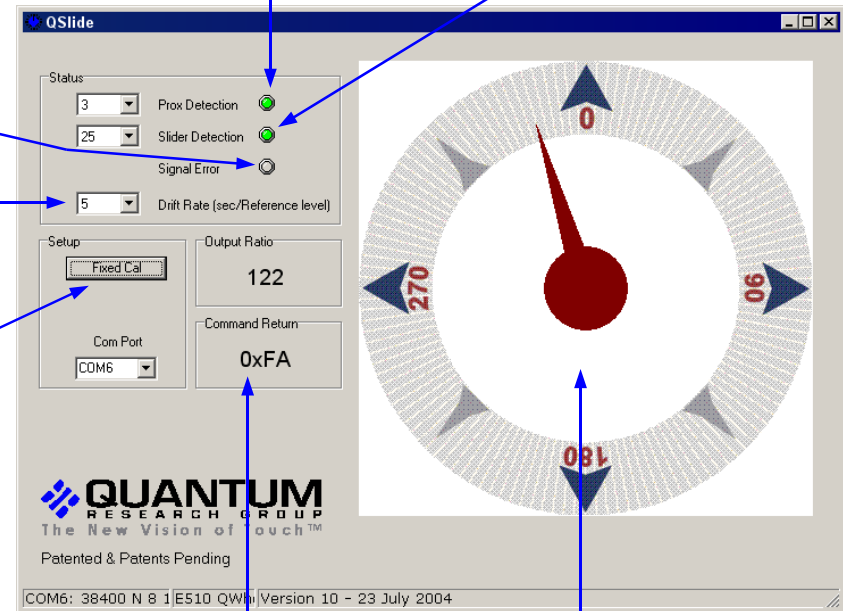

**Command Return** represents the board response byte in HEX.

**Indication Dial** shows the reported position of the touch. This indication does not change when only proximity is detected. It will lock on the last reported position after touch is lifted.

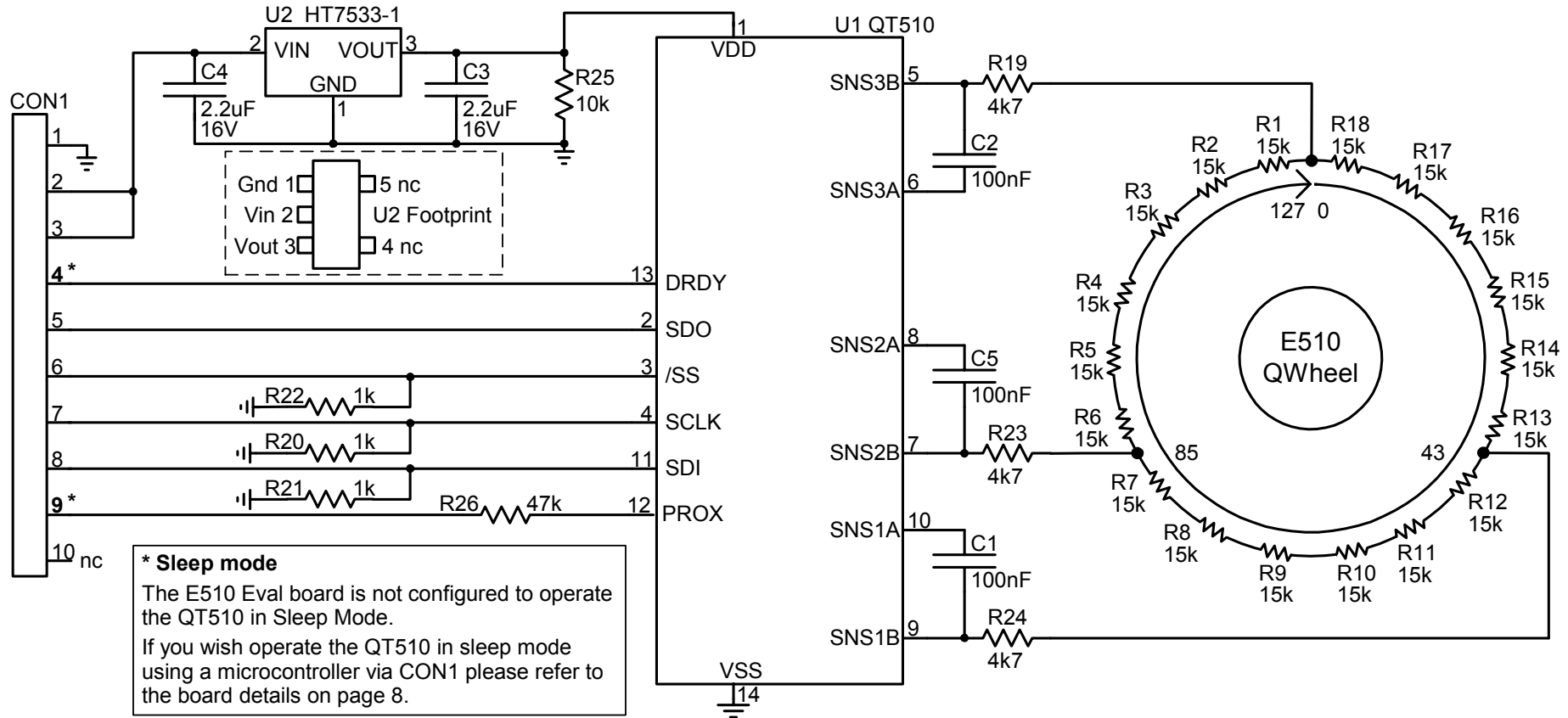

### **SPI Interface Connector**

This connector provides all signals and power needed to communicate with the USB adapter or an external host such as a microcontroller.

If you wish to connect the E510 to a microcontroller and operate the QT510 in **sleep mode** you will need to provide in your interface circuit a 1nF capacitor between PROX (CON1 pin 9) and GND, and a 22k Resistor between DRDY (CON1 pin 4) and GND. Refer to the QT510 Datasheet for more information.

See **Table 1** (*next page*) for a description of the connector pinout.

### **Voltage Regulator**

The E510 uses a low drop out regulator to regulate the 5V supply from the USB adapter box to 3.3V. Resistor R25 is used to provide a minimum load on the regulator when the QT510 sleeps between acquisitions; this is necessary for regulator transient stability.

Since the QT510 works on a lower voltage (3.3V) than the USB box (5.0V), the signals from the USB box to the E510 must be level shifted down. This is done using resistive dividers consisting of 1K resistors R20, R21 and R22, plus a set of 560 ohm resistors placed in series with the signal lines inside the USB box.

### **Rotary Slider Element**

The capacitive rotary slider consists of 18 resistors R1...R18 and the copper pads they connect to. Resistors R19, R23 and R24 provide the QT510 with ESD protection.

### **Sampling Capacitors**

C1 C2 and C5 are the Cs sampling capacitors; increasing their value will increase sensitivity and resolution of measurement, but will also tend to make for a slower response time.

Figure 1 — Board Layout

CON1, Pin # 1 This end

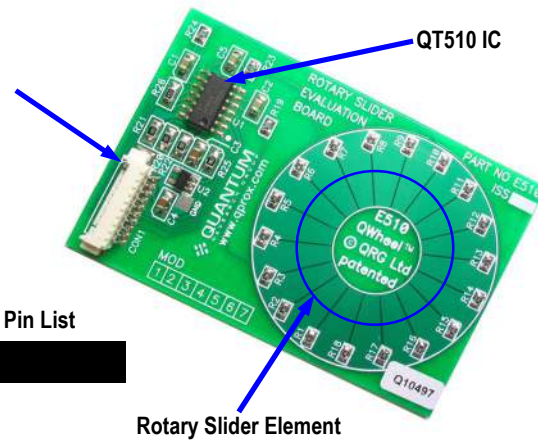

QT510 IC

Rotary Slider Element

Table 1 — Connector (CON1) Pin List

Pin	Description
1	0V (Ground)
2	+5V power
3	+5V power
4	DRDY—data ready (output)
5	SDO—serial data (output)
6	/SS—slave select (input)
7	SCLK—serial clock (input)
8	SDI—serial data (input)
9	PROX—active high (output)
10	Not connected

Mating half for CON1 Molex 51021-1000



# PCB LAYERS

Top Silkscreen

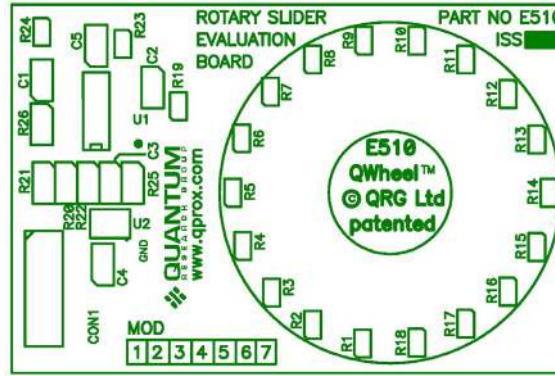

Top Copper

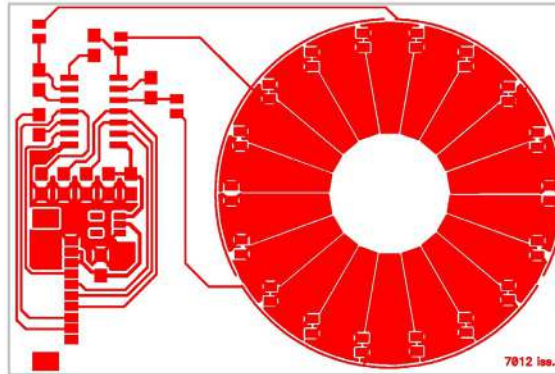

## 10 SOFTWARE INSTALLATION (CD)

If you have a Quantum CD-ROM, follow these steps to install QSlide™ software and USB drivers. If you previously installed such drivers, do not install them again. *If you experience problems, make sure you have administrative rights (e.g. under XP Pro).*

### Install the QSlide™ Signal Viewing Software

To install the QSlide™ viewing software, simply copy the file *Qslide\_V[x].exe* from the supplied CD to your Windows Desktop. The software can be found on the CD in folder **D:\SOFTWARE\** (replace **D:** with the actual drive letter of your CD)

### Install the USB Drivers

Place the CD-ROM in your CD drive.

Connect the USB adapter box to the PC using the supplied USB cable. The E510 may be connected (or not).

Windows will display the **Found New Hardware Wizard** for the **USB <-> Serial Cable**. Select **Install the software automatically** and click **Next**. Windows now installs the drivers. Click **Finish** when prompted.

The **Found New Hardware Wizard** will appear again for the **USB Serial Port** device. Simply repeat the above steps again.

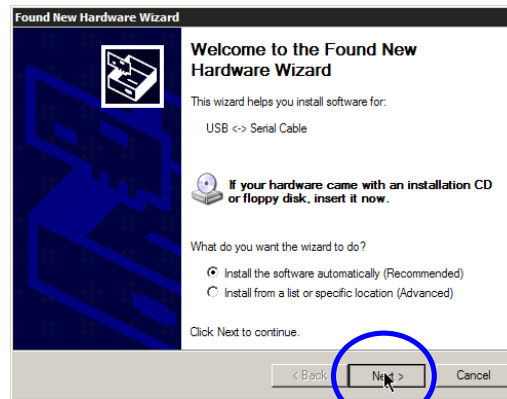

Windows may prompt you to restart your PC at this point; **restarting is not necessary**.

You are now done with the software and driver installation. Go back to page 4.

## SOFTWARE INSTALLATION (WEB) 11

Follow these steps to install QSlide™ software and USB drivers from [www.qprox.com](http://www.qprox.com). If you previously installed such drivers, do not install them again. *If you experience problems, make sure you have administrative rights (e.g. under XP Pro).*

### Create New Folder C:\QRG-USB

Create a new temporary folder to hold the files you are about to download, called **C:\QRG-USB**

### Download and Extract the Files

Go to [www.qprox.com/software](http://www.qprox.com/software) and click on the file [qrg-usb\\_drivers.zip](#) and click **Save**; save the file to **C:\QRG-USB**. Extract all files inside [qrg-usb\\_driver.zip](#) within folder **C:\QRG-USB**.

Now, download QSlide™ software ([Qslide\\_V\[x\].exe](#)) but save this to your Windows Desktop.

### Install the USB Drivers

Follow the USB directions on page 10 except:

When the **Found New Hardware Wizard** appears, select **Install from a list or specific location**. Then, specify the location as **C:\QRG-USB** and click **Next**.

Windows will now install the drivers. Click **Finish** when prompted.

The **Found New Hardware Wizard** will appear again for the **USB Serial Port** device. Simply repeat the above steps again.

You may be prompted to restart your PC; **restarting is not necessary**. You may now delete the temporary folder **C:\QRG-USB**.

You are now done with the software and driver installation. Go back to page 4.

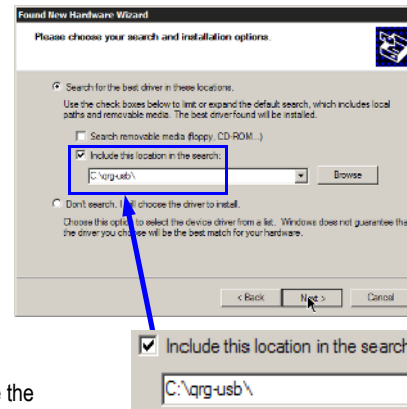

**Board Will  
Not  
Communicate  
with PC****▶ Bad SPI or USB Connections**

- ⇒ Check/replace cables
- ⇒ Make sure the board is getting power and USB light is on solid

**▶ Bad or Conflicting Virtual Comm Port on PC**

- ⇒ See the *Software Installation* section - reinstall driver software, or, change the USB-Serial com port number in Device Manager if there is a conflict

**▶ LED Flashes on USB Adapter (USB box not recognized)**

- ⇒ Disconnect and reconnect the board and USB adapter, take care to connect the QSlide™ board to the USB adapter first as USB box detects the QSlide™ board on power up.

**▶ Board will not Calibrate due to noise** (failure to calibrate will cause the board to cease communications)

- ⇒ See below — Noisy or erratic signal

**Noisy or  
Erratic Signal****▶ Noisy Power Supply** - try a different USB port or PC**▶ Cables or Board too Close to Strong Noise Source** (such as a power line or switching noise source)

- ⇒ Increase the distance from E510 to the noise source
- ⇒ Place a grounded metal shield between the noise source and the QSlide™ board

**▶ QSlide™ Board is not Mechanically Stable**

- ⇒ Prevent board from moving around

**▶ Strong RFI from a Transmitter or Adjacent Digital Product**

- ⇒ Remove the noise source or shield against it

### Corporate Headquarters

1 Mitchell Point  
Ensign Way, Hamble  
Southampton SO31 4RF  
United Kingdom

Tel +44 (0)23 8056 5600  
Fax +44 (0)23 8045 3939  
Email sales1@qprox.com

### North America

651 Holiday Drive Bldg. 5 / 300  
Pittsburgh, PA 15220  
USA

Tel 412-391-7367  
Fax 412-291-1015

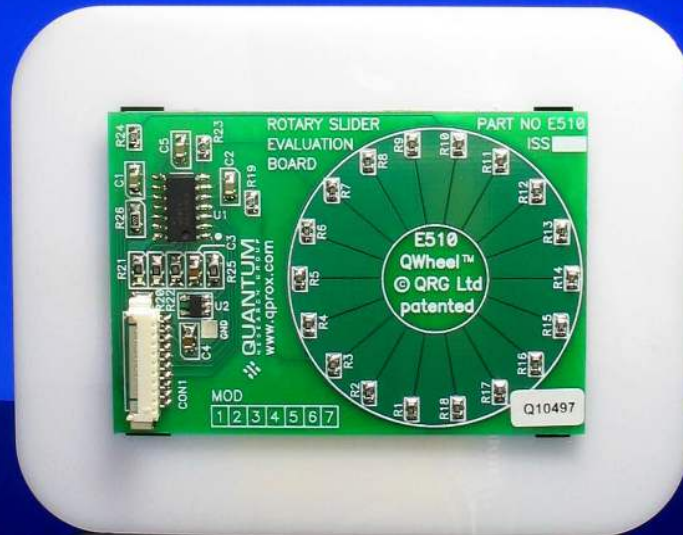

 **QUANTUM**  
RESEARCH GROUP  
www.qprox.com

Copyright © 2004 QRG Ltd  
All rights reserved  
Patented and patents pending

### Development Team:

Martin Simmons, Luben Hristov, Samuel Brunet

REV 201.141004