

THIS PRODUCT MANUFACTURED WITH LEAD-FREE PROCESSING

DESIGNED & DIMENSIONED IN MILLIMETERS [INCHES]

RF23S-XXXXX-XXXXXX-XXXX

DO NOT SCALE FROM THIS PRINT

PATENT NUMBER 7,544,093

CABLE CALLOUT
23S: MWC-2350-01 CABLE

OVERALL ASSEMBLY LENGTH (OAL)
XXXX (MILLIMETERS) (0100 MIN) (SEE NOTE 9)

END 1 CONNECTOR
(SEE TABLE 3, SHT 2)

END 2 CONNECTOR OR PREPARATION
(SEE TABLE 3, SHT 2)

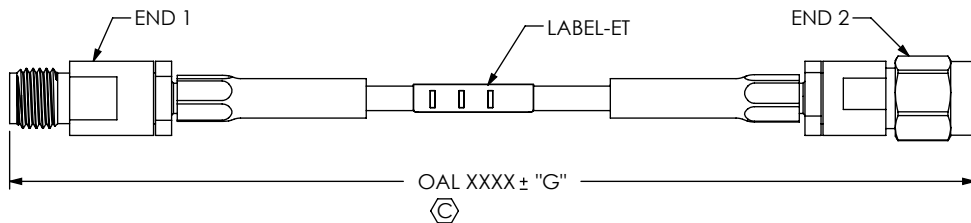

FIG 1
RF23S-92S JX-92SPX-XXXX SHOWN

TABLE 2	
OVERALL LENGTH	"G"
0100-0200 [3.94-7.87]	+3.0 [.12] / -0.0 [0.00]
0201-0500 [7.91-19.69]	+5.0 [.20] / -0.0 [0.00]
0501-1100 [19.72-43.30]	+10.0 [.39] / -0.0 [0.00]
> 1100 [43.30]	± 1%

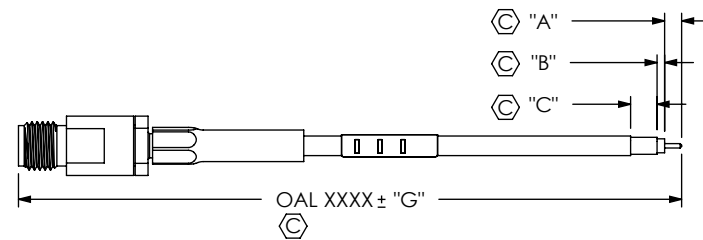

FIG 2
RF23S-92S JX-172849-XXXX SHOWN (SEE NOTE 3 & 5)

"C" (FORMAT: X.X)
"B" (FORMAT: X.X)
"A" (FORMAT: X.X)

DO NOT LEAVE ANY SPACE BLANK, EACH MUST CONTAIN A NUMERIC CHARACTER 0 THRU 9.

NOTES:

- ⊗ REPRESENTS A CRITICAL DIMENSION
- ASSEMBLY TO BE 100% TESTED FOR OPENS, SHORTS & HI-POT TESTED (PER TABLE 1, AC OR DC), THE HI-POT VOLTAGE FOR THE ASSEMBLY SHOULD BE SET TO THE END OPTION WITH THE LOWEST TEST VOLTAGE RATING.
- DIM "A", "B", AND "C" HAVE A MINIMUM VALUE OF 0.0mm & A MAXIMUM VALUE OF 9.9mm.
- FOR STRIPPED AND TINNED OPTION, ONLY THE CENTER CONDUCTOR IS TINNED.
- CONNECTORS TO BE ORIENTED ACCORDING TO CO-RF-WI-3048-M.
- FERRULE AND SPRING ARE FREE FLOATING AND ARE NOT STATIONARY.
- AFTER FINAL ELECTRICAL TEST, LABEL EACH CABLE ASSEMBLY WITH 1 LABEL-ET.
- CABLE ASSEMBLIES TO BE BULK PACKAGED PER PACKAGING STANDARD CO-RF-WI-3040-M.
- CABLE LENGTHS LONGER THAN 1000 MILLIMETERS ARE NOT SUPPORTED BY S.I. TEST DATA.

F:\DWG\MISC\MKTG\RF23S-XXXXX-XXXXXX-XXXX-MKT.SLDDRW

<p>UNLESS OTHERWISE SPECIFIED, DIMENSIONS ARE IN MILLIMETERS [INCHES]. TOLERANCES ARE:</p> <p>DECIMALS ANGLES</p> <p>.X: ±0.3 [.01] 5°</p> <p>.XX: ±0.13 [.005]</p> <p>.XXX: ±0.051 [.0020]</p>	<p>PROPRIETARY NOTE</p> <p>THIS DOCUMENT CONTAINS CONFIDENTIAL AND PROPRIETARY INFORMATION AND ALL DESIGN, MANUFACTURING, REPRODUCTION, USE, PATENT RIGHTS AND SALES RIGHTS ARE EXPRESSLY RESERVED BY SAMTEC, INC. THIS DOCUMENT SHALL NOT BE DISCLOSED, IN WHOLE OR PART, TO ANY UNAUTHORIZED PERSON OR ENTITY NOR REPRODUCED, TRANSFERRED OR INCORPORATED IN ANY OTHER PROJECT IN ANY MANNER WITHOUT THE EXPRESS WRITTEN CONSENT OF SAMTEC, INC.</p>	 <p>520 PARK EAST BLVD. NEW ALBANY, IN 47150 PHONE: 812-944-6733 FAX: 812-948-5047 e-Mail info@SAMTEC.com code 55322</p> <p>DESCRIPTION: RF23S CABLE ASSEMBLY</p> <p>DWG. NO. RF23S-XXXXX-XXXXXX-XXXX</p> <p>BY: EMMA CHEN 12/14/2012 SHEET 1 OF 8</p>
<p>MATERIAL: DO NOT SCALE DRAWING SHEET SCALE: 2:1</p> <p>INNER PINS: BeCu INSULATORS: PTFE (SCC31) PCTFE (OTHERS) GASKETS: SILICONE CABLE BODY, RETAINER, FERRULE: BRASS SPRING, SHELLS, BODY, C-RING, NUT: STAINLESS STEEL</p>		

PATENT NUMBER
7,544,093

TABLE 3							
END OPTION	SERIES	GENDER	CONFIGURATION	PLATING			FIGURE
				CENTER CONTACT	OUTER CONTACT	OTHER COMPONENTS	
-92SJP	2.92 MM	JACK	STRAIGHT	30μ" GOLD	STAINLESS STEEL	3μ" GOLD	SHT 3, FIG 3
-92SPP	2.92 MM	PLUG	STRAIGHT	30μ" GOLD	STAINLESS STEEL	3μ" GOLD	SHT 3, FIG 4
-SCC31	Bulls Eye ®	N/A	N/A	30μ" GOLD	3μ" GOLD	3μ" GOLD	SHT 4, FIG 5
-35SJP	3.50 MM	JACK	STRAIGHT	30μ" GOLD	STAINLESS STEEL	3μ" GOLD	SHT 4, FIG 6
-35SPP	3.50 MM	PLUG	STRAIGHT	30μ" GOLD	STAINLESS STEEL	3μ" GOLD	SHT 5, FIG 7
*-SING	SINGLE ENDED	-	-	-	-	-	-
*-XXXXXX	STRIPPED & TINNED	-	-	-	-	-	SHT 1, FIG 2

* = END 2 OPTION ONLY

TABLE 1						
END OPTION	SUBTRACTOR	STRIP DIMENSIONS			HI POT	
		"Y"	"A"	"D"	"E"	"DC"
-92SJP	7.7 [0.30]	2.25 [0.089]	3.25 [0.128]	6.75 [0.266]	1000	1000
-92SPP	8.5 [0.33]	2.25 [0.089]	3.25 [0.128]	6.75 [0.266]	1000	1000
-SCC31	1.7 [0.07]	2.16 [0.085]	2.16 [0.085]	5.94 [0.234]	1000	750
-35SJP	8.3 [0.33]	1.65 [0.065]	2.45 [0.096]	5.95 [0.234]	1000	1000
-35SPP	9.2 [0.36]	1.65 [0.065]	2.45 [0.096]	5.95 [0.234]	1000	1000
*-SING	0.0 [0.00]	-	-	-	1000	1000
*-XXXXXX	0.0 [0.00]	"A"	"A"+"B"	"A"+"B"+"C"	1000	1000

* = END 2 OPTION ONLY

* PROPRIETARY NOTE *

THIS DOCUMENT CONTAINS CONFIDENTIAL AND PROPRIETARY INFORMATION AND ALL DESIGN, MANUFACTURING, REPRODUCTION, USE, PATENT RIGHTS AND SALES RIGHTS ARE EXPRESSLY RESERVED BY SAMTEC, INC. THIS DOCUMENT SHALL NOT BE DISCLOSED, IN WHOLE OR PART, TO ANY UNAUTHORIZED PERSON OR ENTITY NOR REPRODUCED, TRANSFERRED OR INCORPORATED IN ANY OTHER PROJECT IN ANY MANNER WITHOUT THE EXPRESS WRITTEN CONSENT OF SAMTEC, INC.

DO NOT SCALE DRAWING

SHEET SCALE: 1:1



520 PARK EAST BLVD., NEW ALBANY, IN 47150
PHONE: 812-944-6733 FAX: 812-948-5047
e-Mail info@SAMTEC.com code 55322

DESCRIPTION:	RF23S CABLE ASSEMBLY
DWG. NO.	RF23S-XXXXX-XXXXXX-XXXX
BY:EMMA CHEN 12/14/2012	SHEET 2 OF 8

PATENT NUMBER
7,544,093

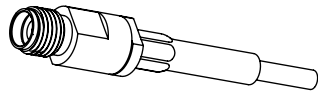
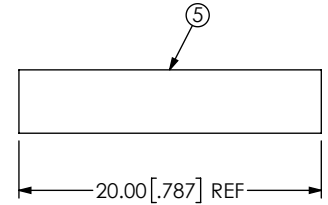
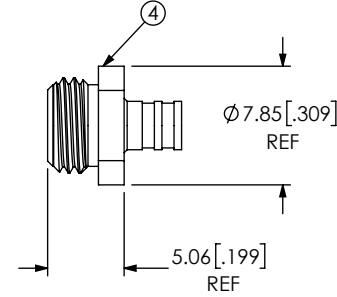
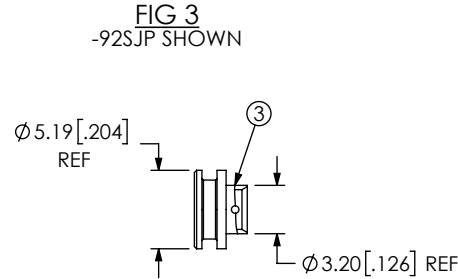
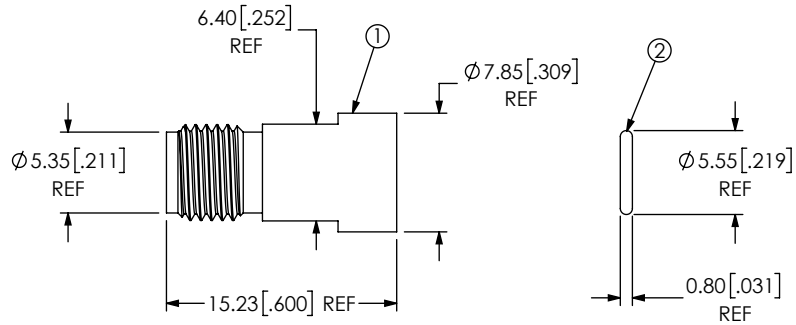

BOM		
ITEM	COMPONENT	-HP
1	SUB ASSEMBLY	SUB-292PS-J-C-HP-ST-CS3
2	GASKET	292-C-ST-GKT
3	CABLE BODY	292-C-F-ST-CS3-CBDY
4	BODY	292PS-C-P-ST-CS3-BDY
5	HEAT SHRINK	HST-0.125-02-BLK-A

FIG 4
-92SPP SHOWN

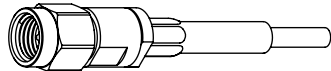
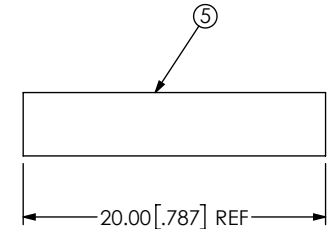
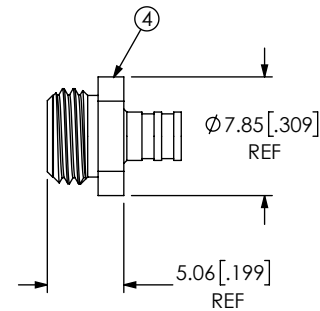
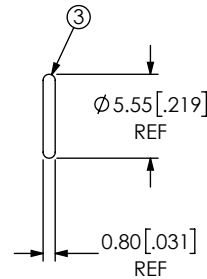
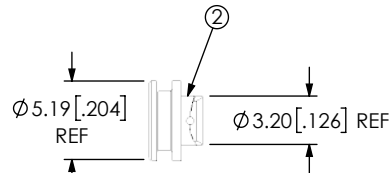
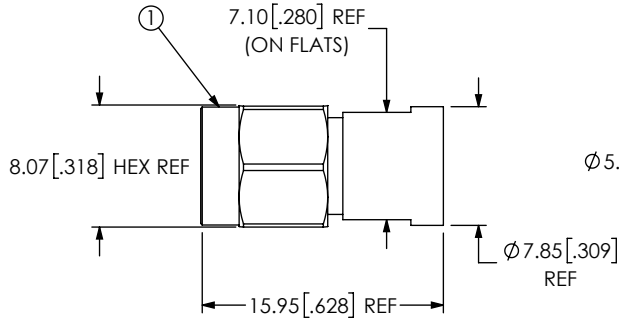

BOM		
ITEM	COMPONENT	-HP
1	SUB ASSEMBLY	SUB-292PS-J-C-HP-ST-CS3
2	CABLE BODY	292-C-F-ST-CS3-CBDY
3	GASKET	292-C-ST-GKT
4	BODY	292PS-C-P-ST-CS3-BDY
5	HEAT SHRINK	HST-0.125-02-BLK-A

PROPRIETARY NOTE
THIS DOCUMENT CONTAINS CONFIDENTIAL AND PROPRIETARY INFORMATION AND ALL DESIGN, MANUFACTURING, REPRODUCTION, USE, PATENT RIGHTS AND SALES RIGHTS ARE EXPRESSLY RESERVED BY SAMTEC, INC. THIS DOCUMENT SHALL NOT BE DISCLOSED, IN WHOLE OR PART, TO ANY UNAUTHORIZED PERSON OR ENTITY NOR REPRODUCED, TRANSFERRED OR INCORPORATED IN ANY OTHER PROJECT IN ANY MANNER WITHOUT THE EXPRESS WRITTEN CONSENT OF SAMTEC, INC.

DO NOT SCALE DRAWING

SHEET SCALE: 2:1



520 PARK EAST BLVD, NEW ALBANY, IN 47150
PHONE: 812-944-6733 FAX: 812-948-5047
e-Mail info@SAMTEC.com code 55322

DESCRIPTION: RF23S CABLE ASSEMBLY

DWG. NO. RF23S-XXXXX-XXXXXX-XXXX

BY:EMMA CHEN 12/14/2012 SHEET 3 OF 8

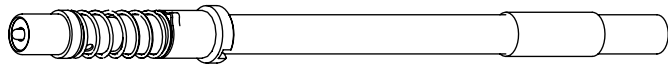
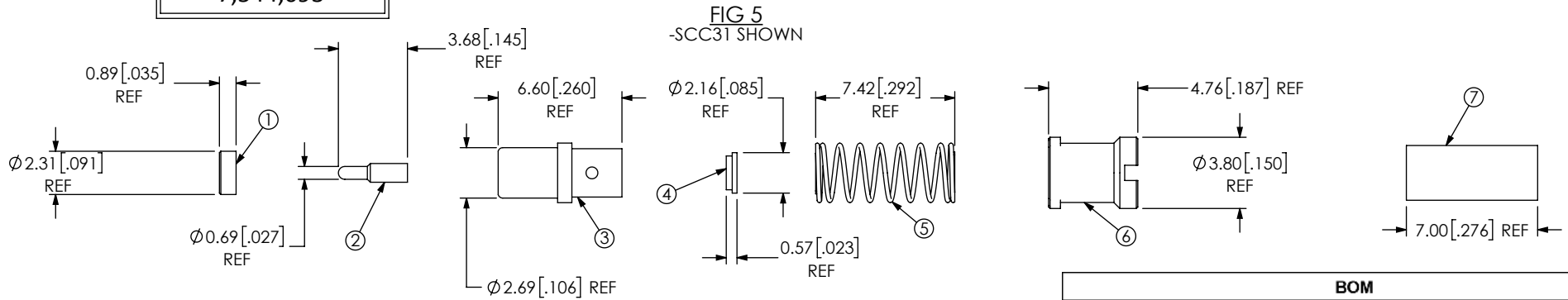

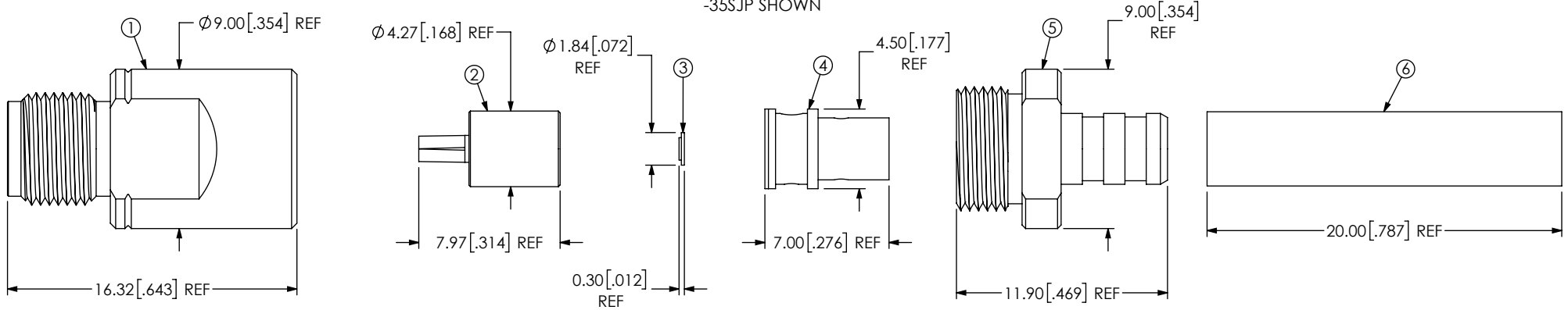

BOM		
ITEM	COMPONENT	-HF
1	INSULATOR 1	PRB3-INS-003
2	PIN	PRB3-PIN-002-H
3	FERRULE	PRB3-FER-002-F
4	RETAINER	PRB3-RET-002-F
5	SPRING	PRB3-SPR-002
6	INSULATOR 2	PRB3-INS-004
7	HEAT SHRINK	HST-0.125-02-BLK

FIG 6
-35SJP SHOWN

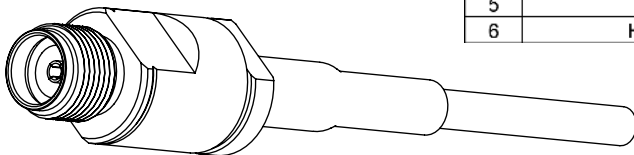

BOM		
ITEM	COMPONENT	-HP
1	SHELL	350-J-C-P-ST-CS3-SHL
2	SUB SOCKET ASSEMBLY	SUB-350-J-C-HP-ST-CS3-SKT
3	INSULATOR	350-ST-CS3-INS
4	CABLE BODY	350-C-F-ST-CS3-CBDY
5	BODY	350-C-P-ST-CS3-BDY
6	HEAT SHRINK	HST-0.125-02-BLK-A



<p>PROPRIETARY NOTE</p> <p>THIS DOCUMENT CONTAINS CONFIDENTIAL AND PROPRIETARY INFORMATION AND ALL DESIGN, MANUFACTURING, REPRODUCTION, USE, PATENT RIGHTS AND SALES RIGHTS ARE EXPRESSLY RESERVED BY SAMTEC, INC. THIS DOCUMENT SHALL NOT BE DISCLOSED, IN WHOLE OR PART, TO ANY UNAUTHORIZED PERSON OR ENTITY NOR REPRODUCED, TRANSFERRED OR INCORPORATED IN ANY OTHER PROJECT IN ANY MANNER WITHOUT THE EXPRESS WRITTEN CONSENT OF SAMTEC, INC.</p> <p>DO NOT SCALE DRAWING</p> <p>SHEET SCALE: 3:1</p>	 <p>520 PARK EAST BLVD, NEW ALBANY, IN 47150 PHONE: 812-944-6733 FAX: 812-948-5047 e-Mail info@SAMTEC.com code 55322</p>
	<p>DESCRIPTION: RF23S CABLE ASSEMBLY</p> <p>DWG. NO. RF23S-XXXXX-XXXXXX-XXXX</p>
<p>BY:EMMA CHEN 12/14/2012 SHEET 4 OF 8</p>	

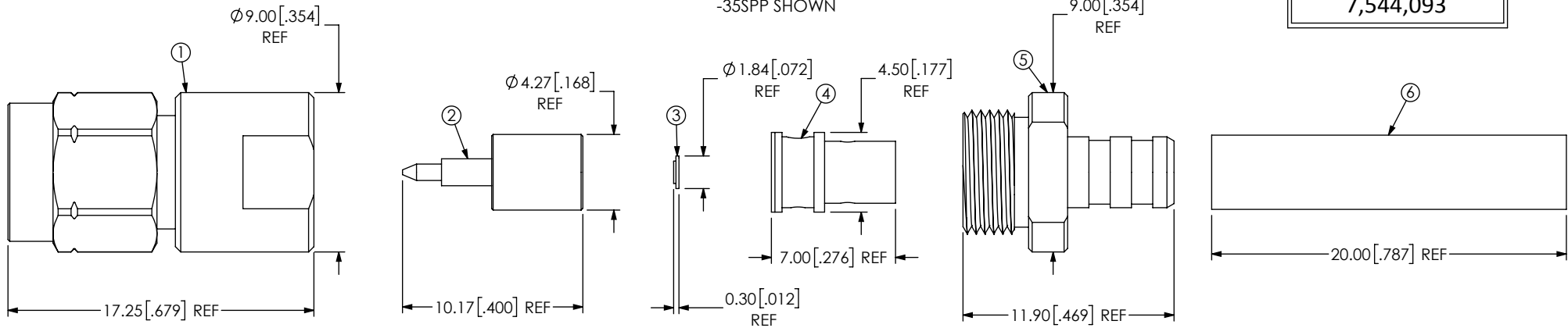
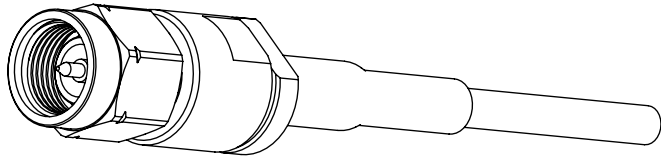

FIG 7
-35SPP SHOWN



BOM		
ITEM	COMPONENT	-HP
1	SUB SHELL ASSEMBLY	SUB-350-P-C-P-ST-CS3-SHL
2	SUB PIN ASSEMBLY	SUB-350-P-C-HP-ST-CS3-PIN
3	INSULATOR	350-ST-CS3-INS
4	CABLE BODY	350-C-F-ST-CS3-CBDY
5	BODY	350-C-P-ST-CS3-BDY
6	HEAT SHRINK	HST-0.125-02-BLK-A

PROPRIETARY NOTE
THIS DOCUMENT CONTAINS CONFIDENTIAL AND PROPRIETARY INFORMATION AND ALL DESIGN, MANUFACTURING, REPRODUCTION, USE, PATENT RIGHTS AND SALES RIGHTS ARE EXPRESSLY RESERVED BY SAMTEC, INC. THIS DOCUMENT SHALL NOT BE DISCLOSED, IN WHOLE OR PART, TO ANY UNAUTHORIZED PERSON OR ENTITY NOR REPRODUCED, TRANSFERRED OR INCORPORATED IN ANY OTHER PROJECT IN ANY MANNER WITHOUT THE EXPRESS WRITTEN CONSENT OF SAMTEC, INC.



520 PARK EAST BLVD, NEW ALBANY, IN 47150
PHONE: 812-944-6733 FAX: 812-948-5047
e-Mail info@SAMTEC.com code 55322

DO NOT SCALE DRAWING

SHEET SCALE: 3:1

DESCRIPTION: RF23S CABLE ASSEMBLY

DWG. NO. RF23S-XXXXX-XXXXXX-XXXX

BY: EMMA CHEN 12/14/2012 SHEET 5 OF 8

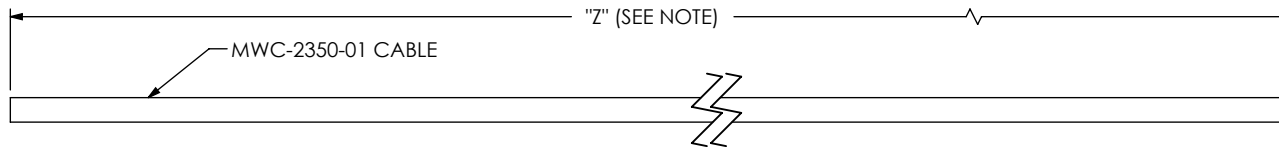

IN PROCESS 1
CUT CABLE TO LENGTH

NOTE: "Z" = 2 * OAL - 2*"Y"(END 1)] (FOR -SING OR -XXXXXX OPTIONS)
"Z" = OAL - "Y"(END 1) - "Y"(END 2) (FOR DOUBLE ENDED OPTIONS)

IN PROCESS 2
STRIP CABLE &
CHAMFER CENTER CONDUCTOR

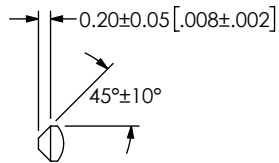

DETAIL 'A'
SCALE 8 : 1

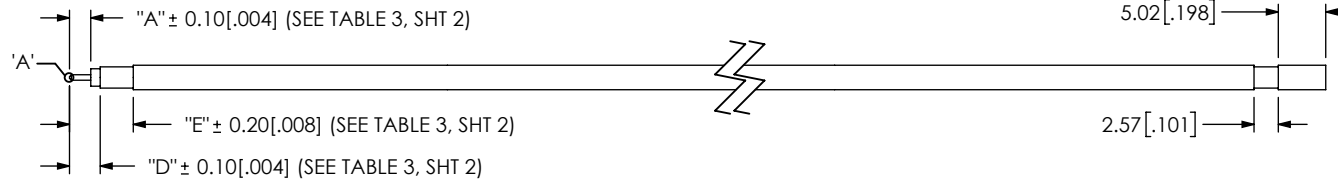

(Bull's Eye ®)
IN PROCESS 2
STRIP AND LOCATE JACKET

IN PROCESS 3
ADD BODY & HEAT SHRINK

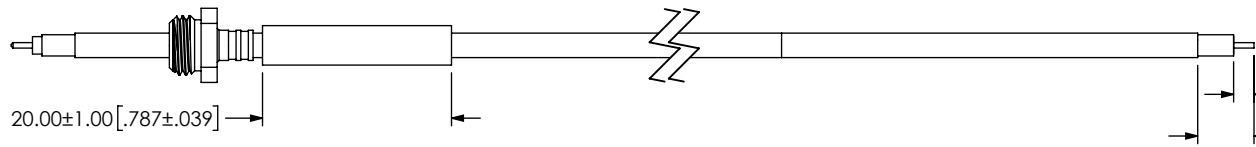

IN PROCESS 3
STRIP AND TIN INNER CONDUCTOR,
REMOVE CUT JACKET

IN PROCESS 4
ADD CABLE BODY
SOLDER CABLE TO CABLE BODY
TRIM DIELECTRIC TO BE FLUSH WITH BODY



SEE NOTE 6

IN PROCESS 4
ADD RETAINER, SPRING
AND HEAT SHRINK TUBE

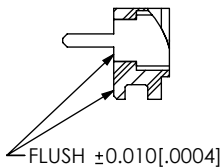

DETAIL 'B'
SCALE 3 : 1

PROPRIETARY NOTE
THIS DOCUMENT CONTAINS CONFIDENTIAL AND PROPRIETARY INFORMATION AND ALL DESIGN, MANUFACTURING, REPRODUCTION, USE, PATENT RIGHTS AND SALES RIGHTS ARE EXPRESSLY RESERVED BY SAMTEC, INC. THIS DOCUMENT SHALL NOT BE DISCLOSED, IN WHOLE OR PART, TO ANY UNAUTHORIZED PERSON OR ENTITY NOR REPRODUCED, TRANSFERRED OR INCORPORATED IN ANY OTHER PROJECT IN ANY MANNER WITHOUT THE EXPRESS WRITTEN CONSENT OF SAMTEC, INC.

DO NOT SCALE DRAWING

SHEET SCALE: 5:4

samtec

520 PARK EAST BLVD, NEW ALBANY, IN 47150
PHONE: 812-944-6733 FAX: 812-948-5047
e-Mail info@SAMTEC.com code 55322

DESCRIPTION: RF23S CABLE ASSEMBLY

DWG. NO. RF23S-XXXXX-XXXXXX-XXXX

BY:EMMA CHEN 12/14/2012 SHEET 6 OF 8

PATENT NUMBER
7,544,093

IN PROCESS 5
ADD GASKET

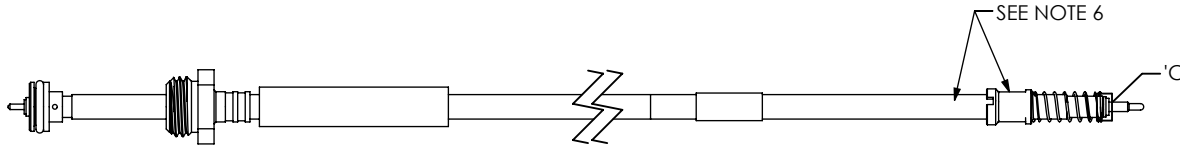

IN PROCESS 5
ADD INSULATOR 2 AND
INDUCTIVE SOLDER PIN

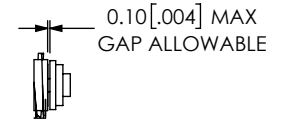

IN PROCESS 6
ADD SUB ASSEMBLY

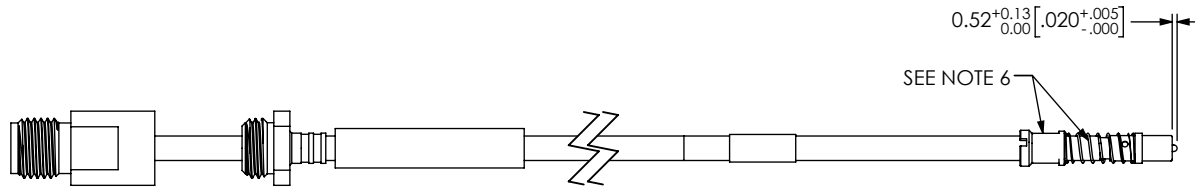

DETAIL 'C'
SCALE 3 : 1

IN PROCESS 6
ADD AND SOLDER FERRULE

IN PROCESS 7
TORQUE SUB ASSEMBLY TO CABLE BODY,
20~30 IN-LBS

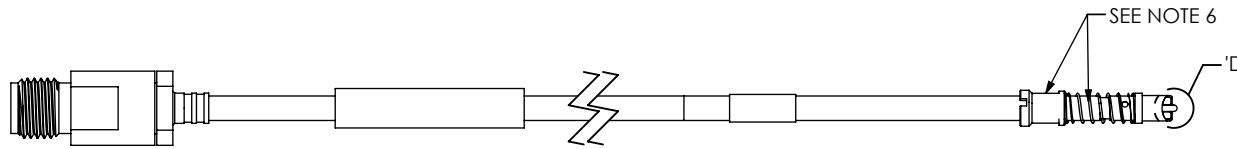

IN PROCESS 7
ADD INSULATOR 1 AND COIN END

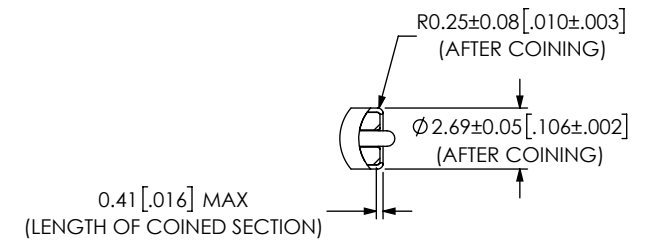

DETAIL 'D'
SCALE 3 : 1

IN PROCESS 8
ACTIVATE HEAT SHRINK

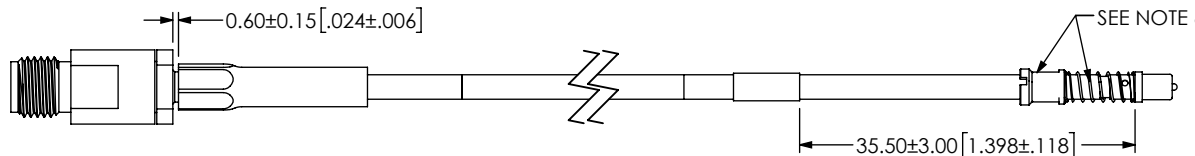

IN PROCESS 8
ACTIVATE HEAT SHRINK

<p>PROPRIETARY NOTE</p> <p>THIS DOCUMENT CONTAINS CONFIDENTIAL AND PROPRIETARY INFORMATION AND ALL DESIGN, MANUFACTURING, REPRODUCTION, USE, PATENT RIGHTS AND SALES RIGHTS ARE EXPRESSLY RESERVED BY SAMTEC, INC. THIS DOCUMENT SHALL NOT BE DISCLOSED, IN WHOLE OR PART, TO ANY UNAUTHORIZED PERSON OR ENTITY NOR REPRODUCED, TRANSFERRED OR INCORPORATED IN ANY OTHER PROJECT IN ANY MANNER WITHOUT THE EXPRESS WRITTEN CONSENT OF SAMTEC, INC.</p> <p>DO NOT SCALE DRAWING</p> <p>SHEET SCALE: 5:4</p>	
	<p>520 PARK EAST BLVD, NEW ALBANY, IN 47150 PHONE: 812-944-6733 FAX: 812-948-5047 e-Mail info@SAMTEC.com code 55322</p>
	<p>DESCRIPTION: RF23S CABLE ASSEMBLY</p>
	<p>DWG. NO. RF23S-XXXXX-XXXXXX-XXXX</p>
<p>BY:EMMA CHEN 12/14/2012 SHEET 7 OF 8</p>	

IN PROCESS 9
PERFORM ELECTRICAL
HIPOT & ADD LABEL NEAR END 1
OR ON BOTH ENDS IF -SING

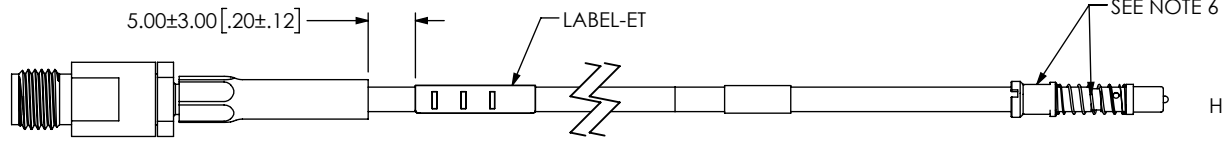

IN PROCESS 9
PERFORM ELECTRICAL
HI-POT & ADD LABEL NEAR END 1
OR ON BOTH ENDS IF -SING

IN PROCESS 10
FOR -SING OR -XXXXXX END 2
OPTION, CUT IN HALF

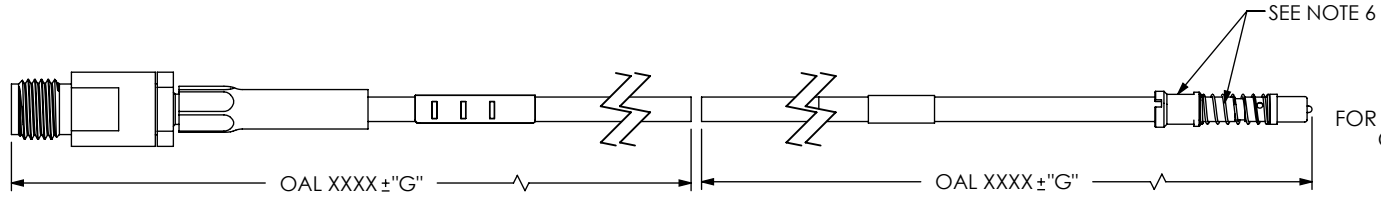

IN PROCESS 10
FOR -SING OR -XXXXXX END 2
OPTION, CUT IN HALF

F:\DWG\MISC\MKTG\RF23S-XXXXX-XXXXXX-XXXX-MKT.SLDDRW

PROPRIETARY NOTE
THIS DOCUMENT CONTAINS CONFIDENTIAL AND PROPRIETARY INFORMATION AND ALL DESIGN, MANUFACTURING, REPRODUCTION, USE, PATENT RIGHTS AND SALES RIGHTS ARE EXPRESSLY RESERVED BY SAMTEC, INC. THIS DOCUMENT SHALL NOT BE DISCLOSED, IN WHOLE OR PART, TO ANY UNAUTHORIZED PERSON OR ENTITY NOR REPRODUCED, TRANSFERRED OR INCORPORATED IN ANY OTHER PROJECT IN ANY MANNER WITHOUT THE EXPRESS WRITTEN CONSENT OF SAMTEC, INC.

DO NOT SCALE DRAWING

SHEET SCALE: 5:4



520 PARK EAST BLVD, NEW ALBANY, IN 47150
PHONE: 812-944-6733 FAX: 812-948-5047
e-Mail info@SAMTEC.com code 5322

DESCRIPTION: RF23S CABLE ASSEMBLY

DWG. NO. RF23S-XXXXX-XXXXXX-XXXX

BY:EMMA CHEN 12/14/2012 SHEET 8 OF 8