

Customer Part:

Description

- Suitable for real time clock applications
32.768kHz output crystal oscillators
Ceramic package with a seam sealed metal lid, hermetically sealed
- Model CFPS-108
- Model Issue number 5

Frequency Parameters

- Frequency 32.7680kHz
- Frequency Stability $\pm 50.00\text{ppm}$
- Operating Temperature Range -40.00 to 85.00°C
- Ageing $\pm 3\text{ppm}$ max per year

Electrical Parameters

- Supply Voltage $2.5\text{V} \pm 5\%$
- Current Draw 2.500mA

Output Details

- Output Compatibility CMOS
- Drive Capability 15pF max
- Rise and Fall Time 50.0ns max
- Duty Cycle $40/60\%$

Output Control

- Standby Operation:
Logic '1' to pad 1 enables oscillator output
Logic '0' to pad 1 disables oscillator output; when disabled the oscillator output goes to the high impedance state
No connection to pad 1 enables oscillator output
- Start-up Time: 35ms max
 2ms typ to 90% of final amplitude (under ideal conditions @ 25°C)
- Standby Current: $10\mu\text{A}$ max, $1.35\mu\text{A}$ typ @ 25°C

Environmental Parameters

- Storage Temperature Range: -55 to 125°C
- Shock: MIL-STD-883F, Method 2002.4: 1500G , 0.5ms , 3 times in each of 3 mutually perpendicular planes.
- Vibration: MIL-STD-883F, Method 2007.3: 20G (20Hz - 2000Hz), 1.52mm amplitude

Manufacturing Details

- RoHS Terminations NiAu
- RoHS Reflow Temp 260degC 10s

Compliance

- RoHS Status (2015/863/EU) Compliant
- REACH Status Compliant
- MSL Rating (JDEC-STD-033): Not Applicable

Packaging Details

- Pack Style: Reel Tape & reel in accordance with EIA-481-D
Pack Size: 1,000
- *Alternative packing option available*

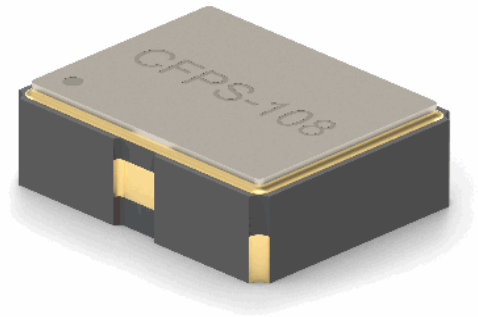
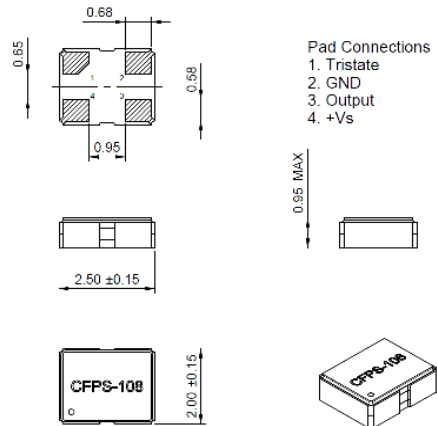
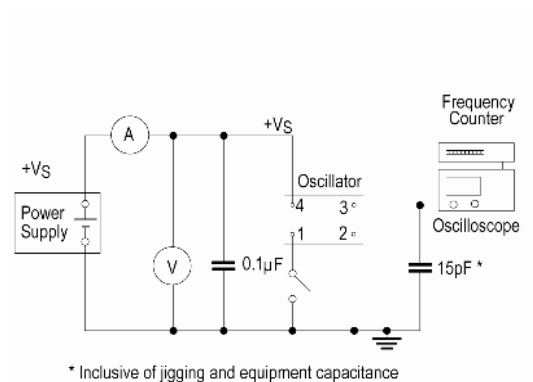
Outline (mm)

Test Circuit

Sales Office Contact Details:

UK: +44 (0)1460 270200

USA: +1.760 668 8935

 Email: info@iqdfrequencyproducts.com

 Web: www.iqdfrequencyproducts.com

Customer Part:

Test Circuit

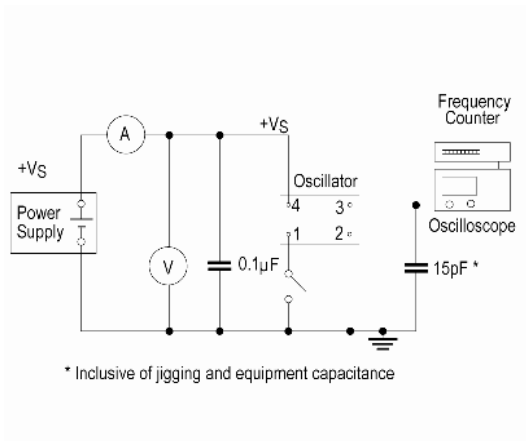

Wave Form

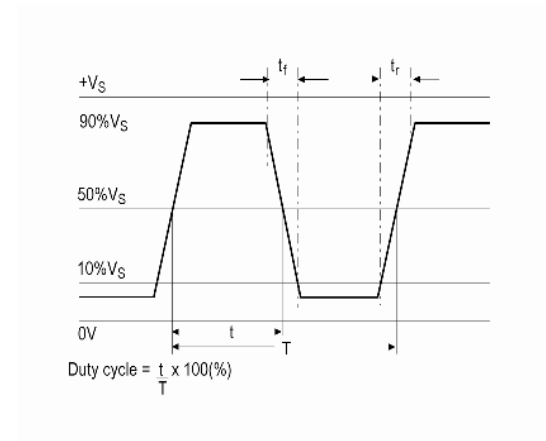

Sales Office Contact Details:

UK: +44 (0)1460 270200

USA: +1.760 668 8935

Email: info@iqdfrequencyproducts.com

Web: www.iqdfrequencyproducts.com