



CANBAT



Model: CLI200-12LT | Voltage: 12.8V | Capacity: 200Ah | Energy: 2560Wh | Group: 4D

ELECTRICAL SPECIFICATIONS

Nominal Voltage	12.8 V
Nominal Capacity	200 Ah
Capacity @ 25A	480 min
Resistance	≤30 mΩ @ 50% SOC
Efficiency	99%
Self Discharge	<3% per Month
Maximum Modules in Parallel or Series	4

CHARGING CHARACTERISTICS

Recommended Charge Current	≤ 100 A
Maximum Charge Current	200 Ah
Floating Charge Voltage	13.8 ±0.2 V
Maximum Charge Voltage	14.6 ±0.2 V
Recommended Charge Voltage (Single Unit)	14.4 V - 14.6 V
BMS Charge Voltage Cut-Off	14.8 V
Reconnect Voltage	14.4 V
Balancing Voltage	13.6 V ± 0.2 V

DISCHARGE SPECIFICATIONS

Maximum Continuous Discharge Current	200 A
Peak Discharge Current	400 A For 3 S
Recommended Low Voltage Disconnect	10 V ± 0.04 V
BMS Discharge Voltage Cut-Off	10 V ± 0.2 V
Reconnect Voltage	11.2 V ± 0.04 V
Short Circuit Protection	200-600 μs

DIMENSIONAL SPECIFICATIONS

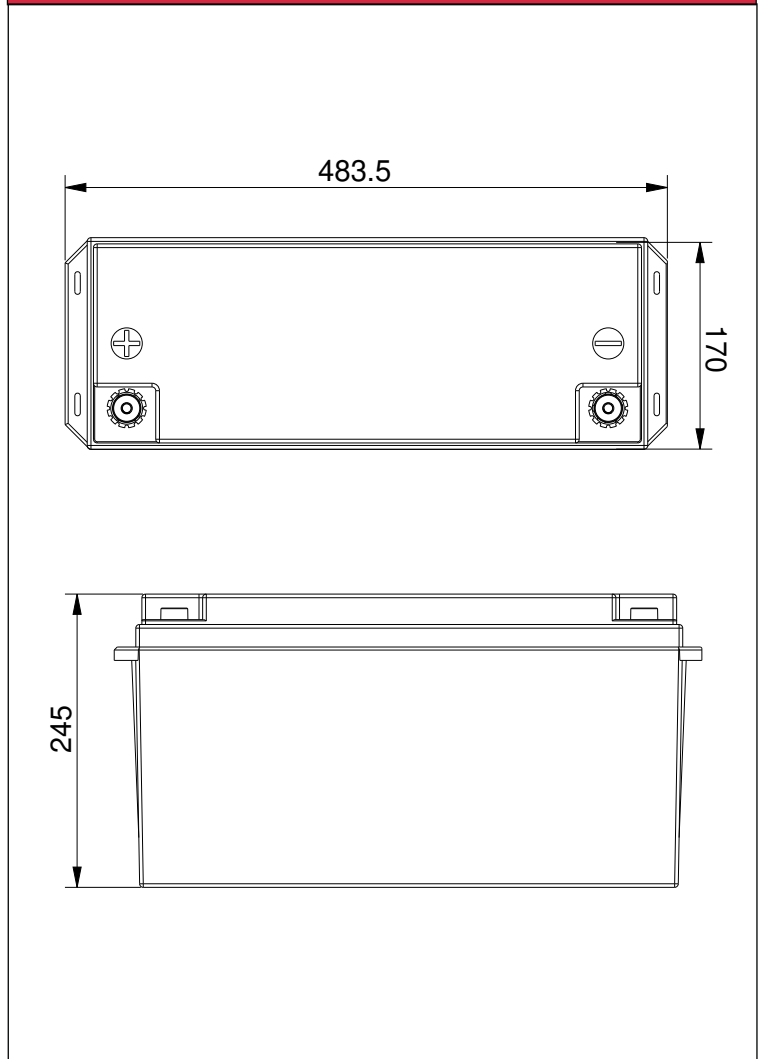

TEMPERATURE SPECIFICATIONS

Discharge Temperature	-20 to 60 °C (-4 to 140 °F)
Charge Temperature*	-20 to 60 °C (-4 to 140 °F)
Recommended Storage Temperature	-5 to 35 °C (23 to 95 °F)
BMS High Temperature Cut-Off	65 °C (149 °F)
Reconnect Temperature	50 °C (122 °F)

BUILT-IN HEATER POWER DRAW: 120W

MECHANICAL SPECIFICATIONS

Dimensions (L x W x H)	19.05 x 6.69 x 9.65" 484 x 170 x 245 mm
Weight	51 lbs (23.13 kg)
Terminal / Thread Pitch	M8 / 1.25
Bolt Length / Thread Depth	12mm / 10mm
Case Material / Torque	ABS / 80-100 in-lbs (9-11 N-m)
IP Rating	IP55
Cell Type - Chemistry	Prismatic - LiFePO4

To ensure safe and efficient operation always refer to the latest edition of our datasheets, as published on our website www.canbat.com. Canbat Technologies Inc. All rights reserved. All trademarks are the property of their respective owners. All data subject to change without notice. E&O.E



Model: CLI200-12LT | Voltage: 12.8V | Capacity: 200Ah | Energy: 2560Wh | Group: 4D

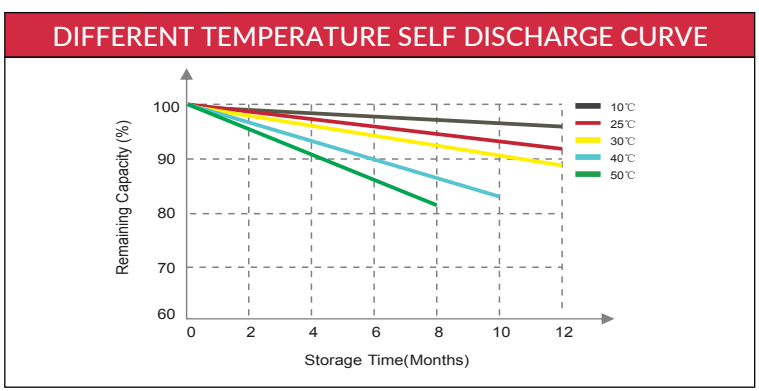
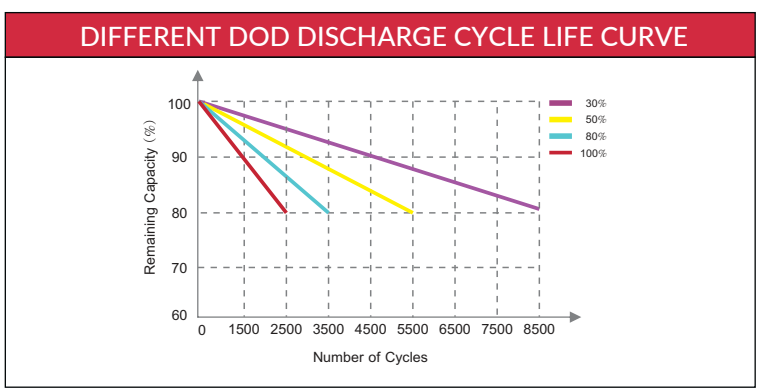
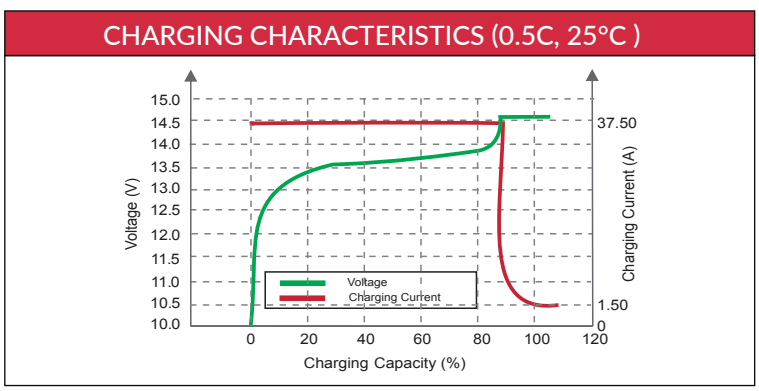
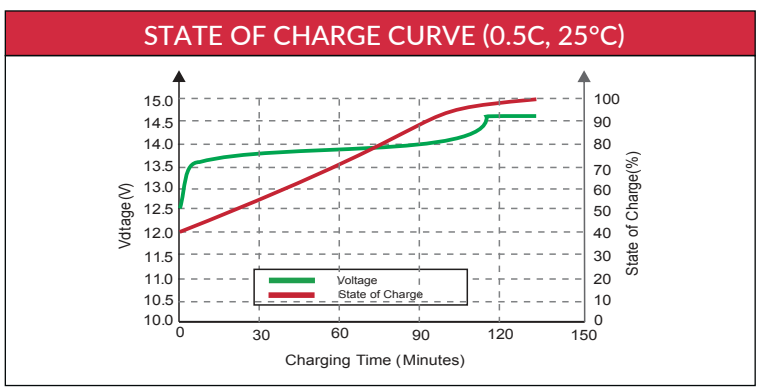
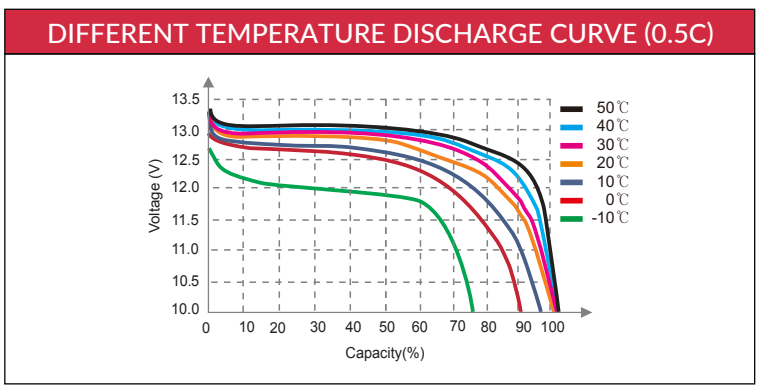
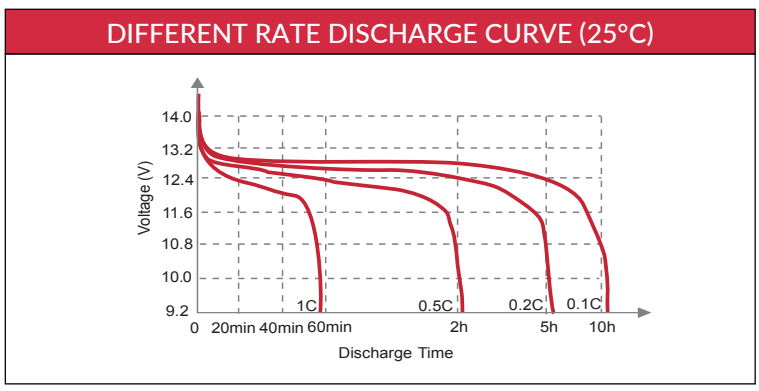

FEATURE LIFEPO4 BATTERY

- MORE CAPACITY :**
Lithium iron provides up to 100% of usable energy, which means you can discharge the battery entirely.
- LIGHTWEIGHT :**
Lithium iron batteries are 60% lighter than lead-acid batteries, allowing for simple installation and transportation.
- INTELLIGENT BMS :**
The battery management system monitors and adapts to battery conditions to maximize performance and safety.
- MINIMAL SELF-DISCHARGE :**
Less than 3% self-discharge per month, which provides you more power when you need it.
- INCREASED FLEXIBILITY :**
Install up to 4 lithium LiFePO4 batteries in series to increase overall voltage or up to 4 in parallel to increase amperage.
- FASTER CHARGING :**
Charges much faster than conventional sealed lead-acid batteries, giving you access to reliable power quicker.
- EASY INSTALLATION :**
Canbat lithium iron batteries are designed to be drop-in replacements for sealed lead-acid batteries.
- HIGH DISCHARGE RATE :**
Ability to deeply discharge the battery at a high rate of discharge while maintaining high energy capacity.
- LONG CYCLE LIFE :**
More than 2,500 cycles at a depth of discharge of 100% and a warranty of 10 years on all lithium batteries.