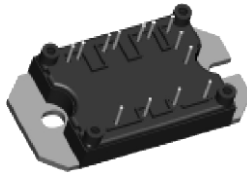


## Three Phase Inverter Module in MTP Package 1200 V NPT IGBT and HEXFRED® Diodes, 5 A



MTP

PRODUCT SUMMARY	
$V_{CES}$	1200 V
$V_{CE(on)}$ typical at $V_{GE} = 15$ V	2.90 V
$I_C$ at $T_C = 100$ °C	5 A
$t_{sc}$ at $T_J = 150$ °C	> 10 $\mu$ s

### FEATURES

- Generation 5 NPT 1200 V IGBT technology
- HEXFRED® diode with ultrasoft reverse recovery
- Very low conduction and switching losses
- Optional SMT thermistor (NTC)
- Aluminum oxide DBC
- Very low stray inductance design for high speed operation
- Short circuit 10  $\mu$ s
- Square RBSOA
- Operating frequencies 8 kHz to 60 kHz
- UL approved file E78996
- Compliant to RoHS directive 2002/95/EC
- Designed and qualified for industrial level


**RoHS**  
COMPLIANT

### BENEFITS

- Optimized for inverter motor drive applications
- Low EMI, requires less snubbing
- Direct mounting to heatsink
- PCB solderable terminals
- Very low junction to case thermal resistance

ABSOLUTE MAXIMUM RATINGS				
PARAMETER	SYMBOL	TEST CONDITIONS	MAX.	UNITS
Collector to emitter voltage	$V_{CES}$		1200	V
Continuous collector current	$I_C$	$T_C = 25$ °C	12	A
		$T_C = 100$ °C	5	
Pulsed collector current	$I_{CM}$		24	
Peak switching current	$I_{LM}$		24	
Diode continuous forward current	$I_F$	$T_C = 100$ °C	5	
Peak diode forward current	$I_{FM}$		12	
Gate to emitter voltage	$V_{GE}$		$\pm 20$	V
RMS isolation voltage	$V_{ISOL}$	Any terminal to case, $t = 1$ min	2500	
Maximum power dissipation (including diode and IGBT)	$P_D$	$T_C = 25$ °C	76	W
		$T_C = 100$ °C	31	

<b>ELECTRICAL SPECIFICATIONS</b> ( $T_J = 25\text{ }^\circ\text{C}$ unless otherwise specified)						
PARAMETER	SYMBOL	TEST CONDITIONS	MIN.	TYP.	MAX.	UNITS
Collector to emitter breakdown voltage	$V_{(BR)CES}$	$V_{GE} = 0\text{ V}, I_C = 250\text{ }\mu\text{A}$	1200	-	-	V
Temperature coefficient of $V_{(BR)CES}$	$\Delta V_{(BR)CES}/\Delta T_J$	$V_{GE} = 0\text{ V}, I_C = 1\text{ mA}$ (25 °C to 125 °C)	-	1.14	-	V/°C
Collector to emitter voltage	$V_{CE(on)}$	$V_{GE} = 15\text{ V}, I_C = 6\text{ A}$	-	2.90	3.17	V
		$V_{GE} = 15\text{ V}, I_C = 12\text{ A}$	-	4.04	4.46	
		$V_{GE} = 15\text{ V}, I_C = 6\text{ A}, T_J = 125\text{ }^\circ\text{C}$	-	3.45	3.60	
		$V_{GE} = 15\text{ V}, I_C = 12\text{ A}, T_J = 125\text{ }^\circ\text{C}$	-	5.07	5.32	
Gate threshold voltage	$V_{GE(th)}$	$I_C = 250\text{ }\mu\text{A}$	4	-	6	
Temperature coefficient of threshold voltage	$\Delta V_{GE(th)}/\Delta T_J$	$V_{CE} = V_{GE}, I_C = 1\text{ mA}$ (25 °C to 125 °C)	-	- 10	-	mV/°C
Forward transconductance	$g_{fe}$	$V_{CE} = 25\text{ V}, I_C = 6\text{ A}$	-	3.2	-	S
Collector to emitter leaking current	$I_{CES}$	$V_{GE} = 0\text{ V}, V_{CE} = 1200\text{ V}$	-	-	250	$\mu\text{A}$
		$V_{GE} = 0\text{ V}, V_{CE} = 1200\text{ V}, T_J = 125\text{ }^\circ\text{C}$	-	-	1000	
Diode forward voltage drop	$V_{FM}$	$I_F = 6\text{ A}, V_{GE} = 0\text{ V}$	-	2.33	2.77	V
		$I_F = 12\text{ A}, V_{GE} = 0\text{ V}$	-	3.01	3.63	
		$I_F = 6\text{ A}, V_{GE} = 0\text{ V}, T_J = 125\text{ }^\circ\text{C}$	-	2.55	2.98	
		$I_F = 12\text{ A}, V_{GE} = 0\text{ V}, T_J = 125\text{ }^\circ\text{C}$	-	3.45	4.07	
Gate to emitter leakage current	$I_{GES}$	$V_{GE} = \pm 20\text{ V}$	-	-	$\pm 250$	nA

<b>SWITCHING CHARACTERISTICS</b> ( $T_J = 25\text{ }^\circ\text{C}$ unless otherwise specified)						
PARAMETER	SYMBOL	TEST CONDITIONS	MIN.	TYP.	MAX.	UNITS
Total gate charge (turn-on)	$Q_g$	$I_C = 6\text{ A}$ $V_{CC} = 600\text{ V}$ $V_{GE} = 15\text{ V}$	-	27	41	nC
Gate to emitter charge (turn-on)	$Q_{ge}$		-	3.7	5.6	
Gate to collector charge (turn-on)	$Q_{gc}$		-	14	21	
Turn-on switching loss	$E_{on}$	$I_C = 6\text{ A}, V_{CC} = 600\text{ V}, V_{GE} = 15\text{ V}$ $R_g = 10\text{ }\Omega, L = 2.0\text{ mH}, T_J = 25\text{ }^\circ\text{C}$ Energy losses include tail and diode reverse recovery	-	0.606	0.909	mJ
Turn-off switching loss	$E_{off}$		-	0.340	0.510	
Total switching loss	$E_{tot}$		-	0.946	1.420	
Turn-on switching loss	$E_{on}$	$I_C = 6\text{ A}, V_{CC} = 600\text{ V}, V_{GE} = 15\text{ V}$ $R_g = 10\text{ }\Omega, L = 2.0\text{ mH}, T_J = 125\text{ }^\circ\text{C}$ Energy losses include tail and diode reverse recovery	-	0.779	1.170	mJ
Turn-off switching loss	$E_{off}$		-	0.403	0.605	
Total switching loss	$E_{tot}$		-	1.182	1.775	
Turn-on delay time	$t_{d(on)}$	$I_C = 6\text{ A}, V_{CC} = 600\text{ V}, V_{GE} = 15\text{ V}$ $L = 2.0\text{ mH}, L_S = 100\text{ nH}$ $R_g = 10\text{ }\Omega, T_J = 125\text{ }^\circ\text{C}$	-	47	71	ns
Rise time	$t_r$		-	17	26	
Turn-off delay time	$t_{d(off)}$		-	99	150	
Fall time	$t_f$		-	362	543	
Reverse BIAS safe operating area	RBSOA	$T_J = 150\text{ }^\circ\text{C}, I_C = 24\text{ A}$ $R_g = 10\text{ }\Omega, V_{GE} = 15\text{ V to }0$	Fullsquare			
Short circuit safe operating area	SCSOA	$V_{CC} = 600\text{ V}, V_{GE} = +15\text{ V to }0$ $T_J = 150\text{ }^\circ\text{C}, V_P = 1200\text{ V}, R_g = 10\text{ }\Omega$	10	-	-	$\mu\text{s}$
Input capacitance	$C_{ies}$	$V_{GE} = 0\text{ V}$ $V_{CC} = 30\text{ V}$ $f = 1\text{ MHz}$	-	369	554	pF
Output capacitance	$C_{oes}$		-	244	366	
Reverse transfer capacitance	$C_{res}$		-	12	18	
Diode reverse recovery energy	$E_{rec}$	$I_C = 6\text{ A}, V_{CC} = 600\text{ V}, V_{GE} = 15\text{ V}$ $L = 2.0\text{ mH}, L_S = 100\text{ nH}$ $R_g = 10\text{ }\Omega, T_J = 125\text{ }^\circ\text{C}$	-	334	-	$\mu\text{J}$
Diode reverse recovery time	$t_{rr}$		-	54	-	ns
Diode peak reverse current	$I_{rr}$		-	17	-	A



THERMISTOR SPECIFICATIONS (T CODE ONLY)						
PARAMETER	SYMBOL	TEST CONDITIONS	MIN.	TYP.	MAX.	UNITS
Resistance	$R_0$ <sup>(1)</sup>	$T_0 = 25\text{ }^\circ\text{C}$	-	30	-	k $\Omega$
Sensitivity index of the thermistor material	$\beta$ <sup>(1)(2)</sup>	$T_0 = 25\text{ }^\circ\text{C}$ $T_1 = 85\text{ }^\circ\text{C}$	-	4000	-	K

**Notes**

(1)  $T_0, T_1$  are thermistor's temperatures

(2)  $\frac{R_0}{R_1} = \exp\left[\beta\left(\frac{1}{T_0} - \frac{1}{T_1}\right)\right]$

THERMAL AND MECHANICAL SPECIFICATIONS						
PARAMETER	SYMBOL	TEST CONDITIONS	MIN.	TYP.	MAX.	UNITS
Operating junction temperature range	$T_J$		- 40	-	150	$^\circ\text{C}$
Storage temperature range	$T_{Stg}$		- 40	-	125	
Junction to case	IGBT	$R_{thJC}$	-	-	2.68	$^\circ\text{C/W}$
	Diode		-	-	4.2	
Case to sink per module	$R_{thCS}$	Heatsink compound thermal conductivity = 1 W/mK	-	0.06	-	
Mounting torque			-	-	4	Nm
Weight			-	65	-	g

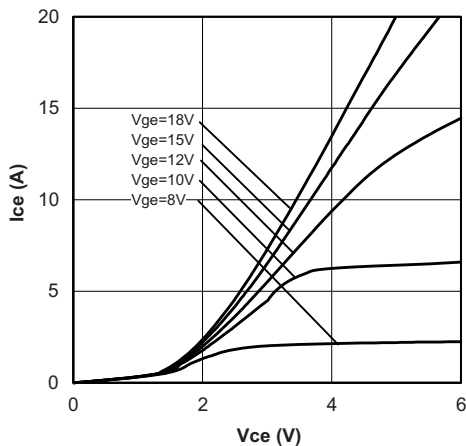


Fig. 1 - Typical Output Characteristics  
 $T_J = 25\text{ }^\circ\text{C}$

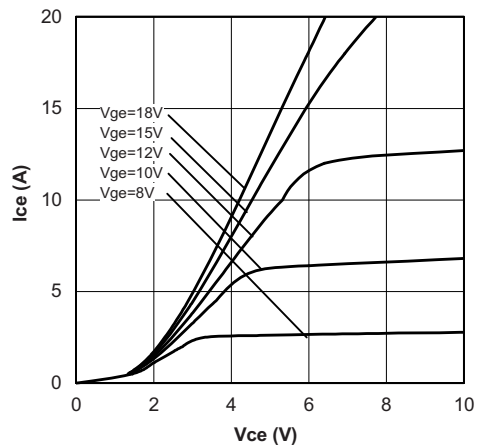


Fig. 2 - Typical Output Characteristics  
 $T_J = 125\text{ }^\circ\text{C}$

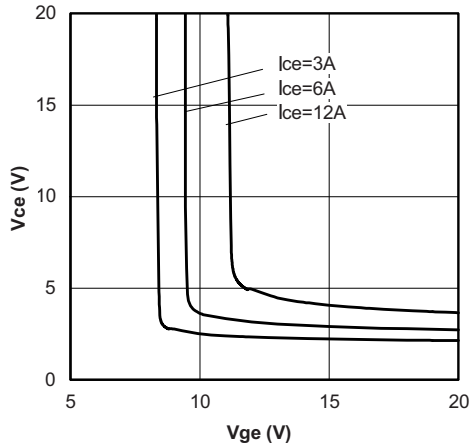


Fig. 3 - Typical  $V_{CE}$  vs.  $V_{GE}$   
 $T_J = 25\text{ }^\circ\text{C}$

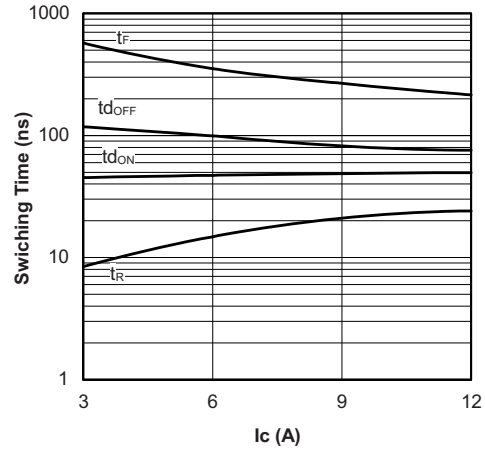


Fig. 6 - Typical Switching Time vs.  $I_C$   
 $T_J = 125\text{ }^\circ\text{C}$ ,  $L = 2\text{ mH}$ ,  $V_{CE} = 600\text{ V}$   
 $R_g = 10\text{ }\Omega$ ;  $V_{GE} = 15\text{ V}$

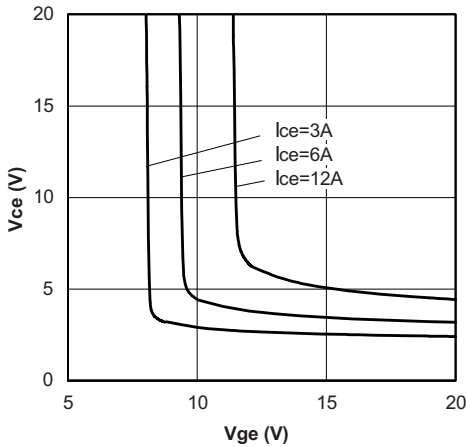


Fig. 4 - Typical  $V_{CE}$  vs.  $V_{GE}$   
 $T_J = 125\text{ }^\circ\text{C}$

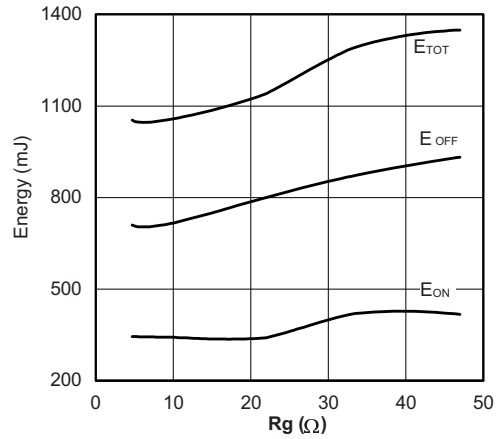


Fig. 7 - Typical Energy Loss vs.  $R_g$   
 $T_J = 125\text{ }^\circ\text{C}$ ,  $L = 2\text{ mH}$ ,  $V_{CE} = 600\text{ V}$   
 $I_C = 6\text{ A}$ ;  $V_{GE} = 15\text{ V}$

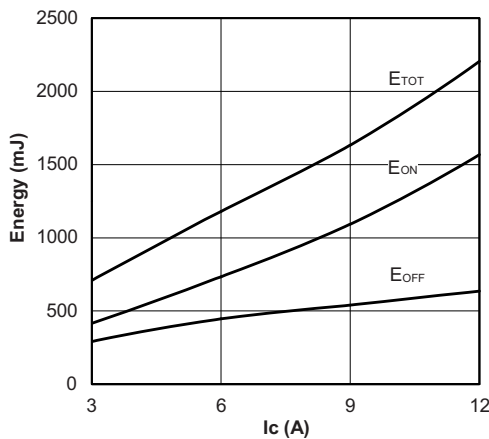


Fig. 5 - Typical Energy Loss vs.  $I_C$   
 $T_J = 125\text{ }^\circ\text{C}$ ,  $L = 2\text{ mH}$ ,  $V_{CE} = 600\text{ V}$   
 $R_g = 10\text{ }\Omega$ ;  $V_{GE} = 15\text{ V}$

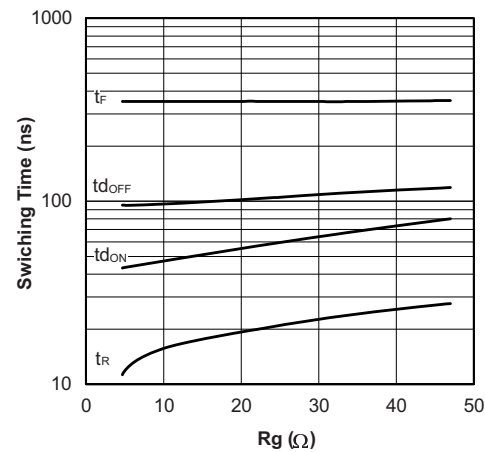


Fig. 8 - Typical Switching Time vs.  $R_g$   
 $T_J = 125\text{ }^\circ\text{C}$ ,  $L = 2\text{ mH}$ ,  $V_{CE} = 600\text{ V}$   
 $I_C = 6\text{ A}$ ;  $V_{GE} = 15\text{ V}$

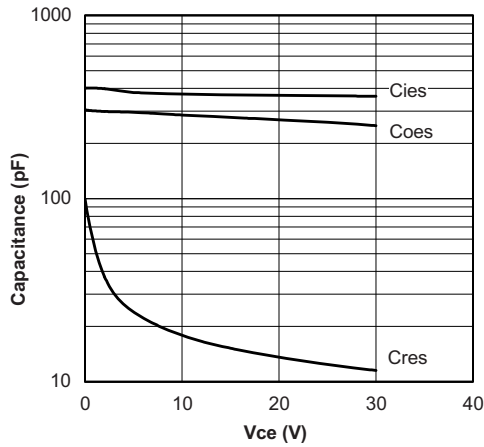


Fig. 9 - Typical Capacitance vs.  $V_{CE}$   
 $V_{GE} = 0 \text{ V}$ ;  $f = 1 \text{ MHz}$

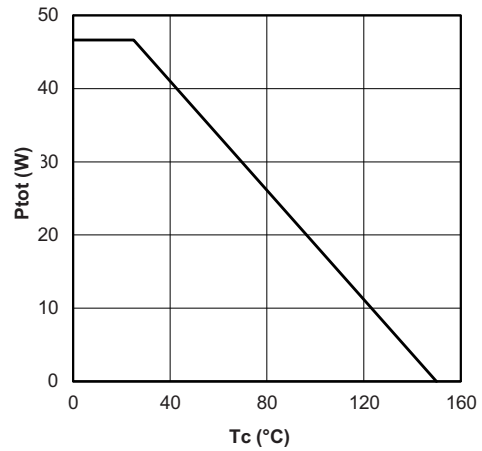


Fig. 12 - Power Dissipation vs. Case Temperature  
(IGBT only)

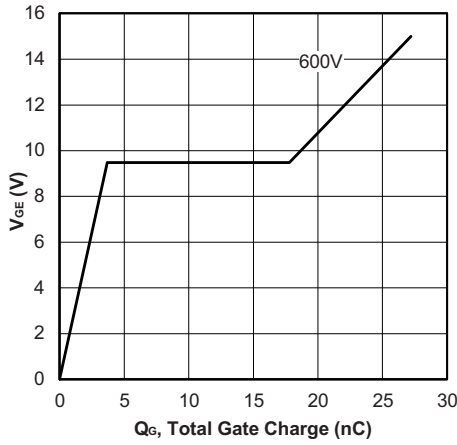


Fig. 10 - Typical Gate Charge vs.  $V_{GE}$   
 $I_{CE} = 5 \text{ A}$

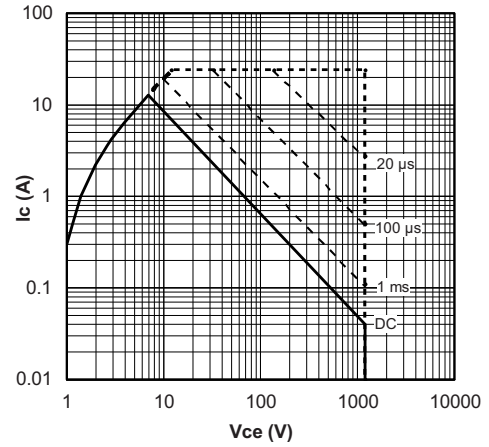


Fig. 13 - Forward SOA  
 $T_C = 25 \text{ }^\circ\text{C}$ ,  $T_J \leq 150 \text{ }^\circ\text{C}$

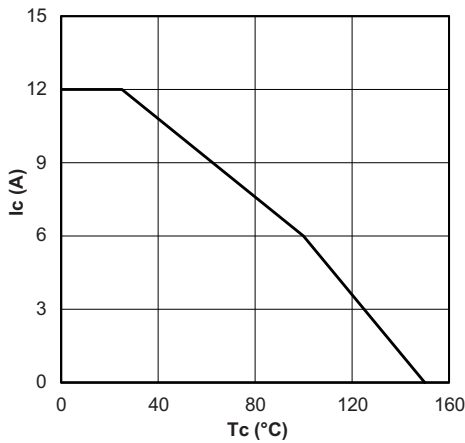


Fig. 11 - Maximum DC Collector Current vs. Case Temperature

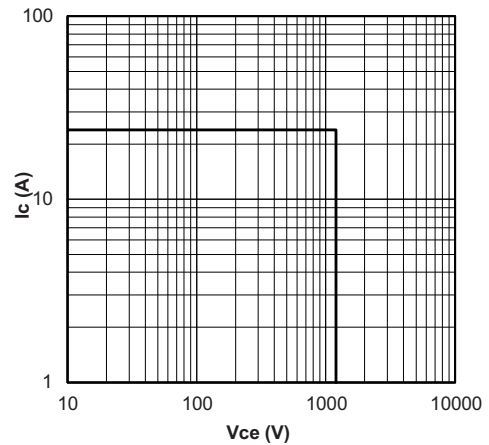


Fig. 14 - Reverse BIAS SOA  
 $T_J = 150 \text{ }^\circ\text{C}$ ,  $V_{GE} = 15 \text{ V}$

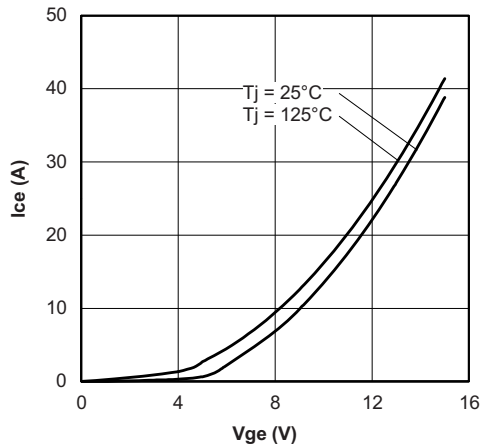


Fig. 15 - Typical Transfer Characteristics  
 $V_{CE} = 50 \text{ V}$ ;  $t_p = 10 \mu\text{s}$

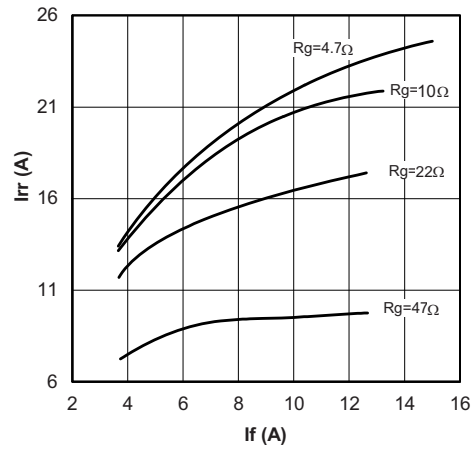


Fig. 17 - Typical Diode  $I_{rr}$  vs.  $I_F$   
 $T_J = 125^\circ\text{C}$

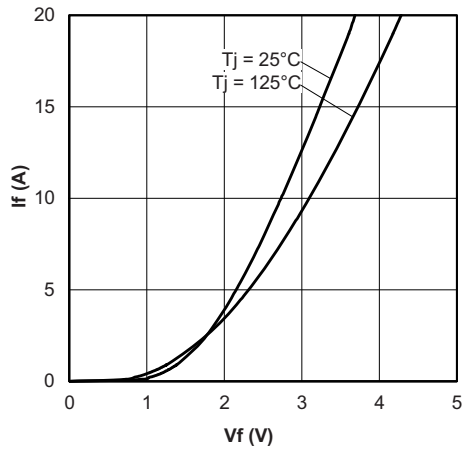


Fig. 16 - Typical Diode Forward Characteristics  
 $t_p = 80 \mu\text{s}$

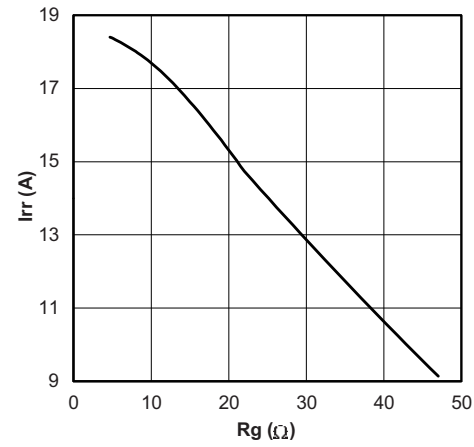


Fig. 18 - Typical Diode  $I_{rr}$  vs.  $R_g$   
 $T_J = 125^\circ\text{C}$ ;  $I_F = 10 \text{ A}$

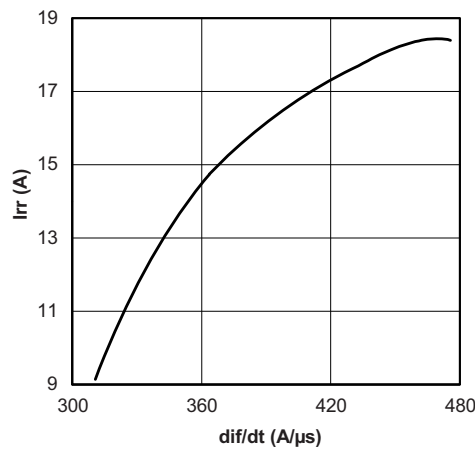


Fig. 19 - Typical Diode  $I_{rr}$  vs.  $dI_F/dt$ ;  $V_{CC} = 600 \text{ V}$ ;  
 $V_{GE} = 15 \text{ V}$ ;  $I_{CE} = 10 \text{ A}$ ,  $T_J = 125^\circ\text{C}$

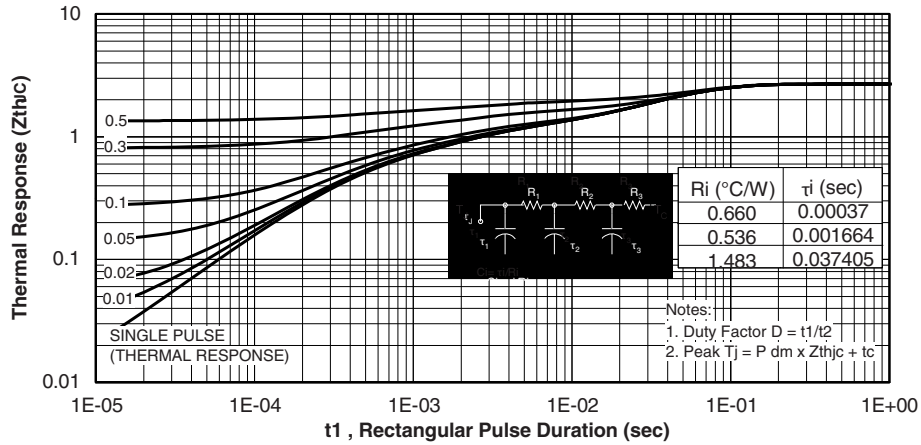
**Three Phase Inverter Module in MTP Package Vishay Semiconductors**  
**1200 V NPT IGBT and HEXFRED® Diodes, 5 A**


Fig. 20 - Maximum Transient Thermal Impedance, Junction to Case (IGBT)

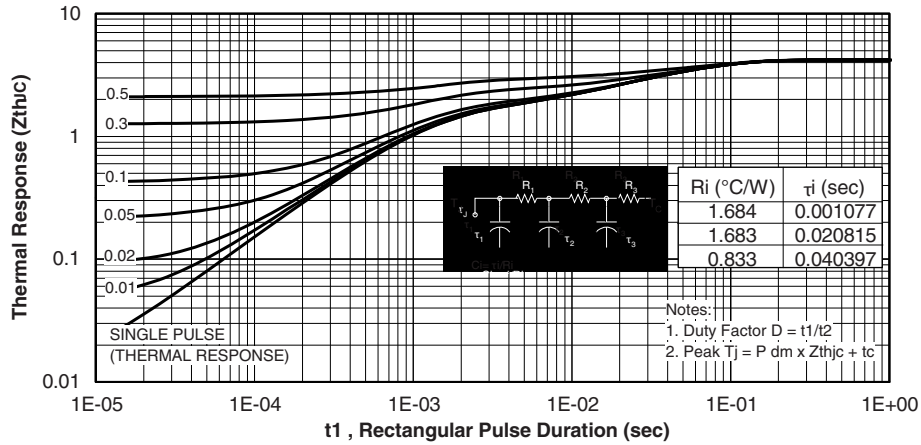


Fig. 21 - Maximum Transient Thermal Impedance, Junction to Case (Diode)

# GB05XP120KTPbF



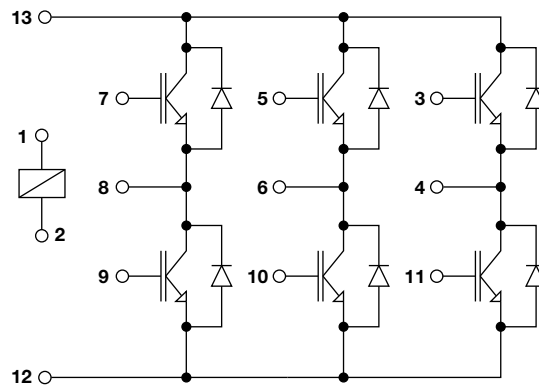
Vishay Semiconductors Three Phase Inverter Module in MTP Package  
1200 V NPT IGBT and HEXFRED® Diodes, 5 A

## ORDERING INFORMATION TABLE

Device code	<b>GB</b>	<b>05</b>	<b>XP</b>	<b>120</b>	<b>K</b>	<b>T</b>	<b>PbF</b>
	①	②	③	④	⑤	⑥	⑦

- 1** - IGBT module
- 2** - Nominal current rating (05 = 5 A)
- 3** - Circuit configuration (XP = Sixpack MTP package)
- 4** - Voltage code (120 = 1200 V)
- 5** - Speed/type (K = Ultrafast IGBT/inverter motor drive application)
- 6** - Special option:
  - None = No special option
  - T = Thermistor
- 7** - PbF = Lead (Pb)-free

## CIRCUIT CONFIGURATION



### LINKS TO RELATED DOCUMENTS

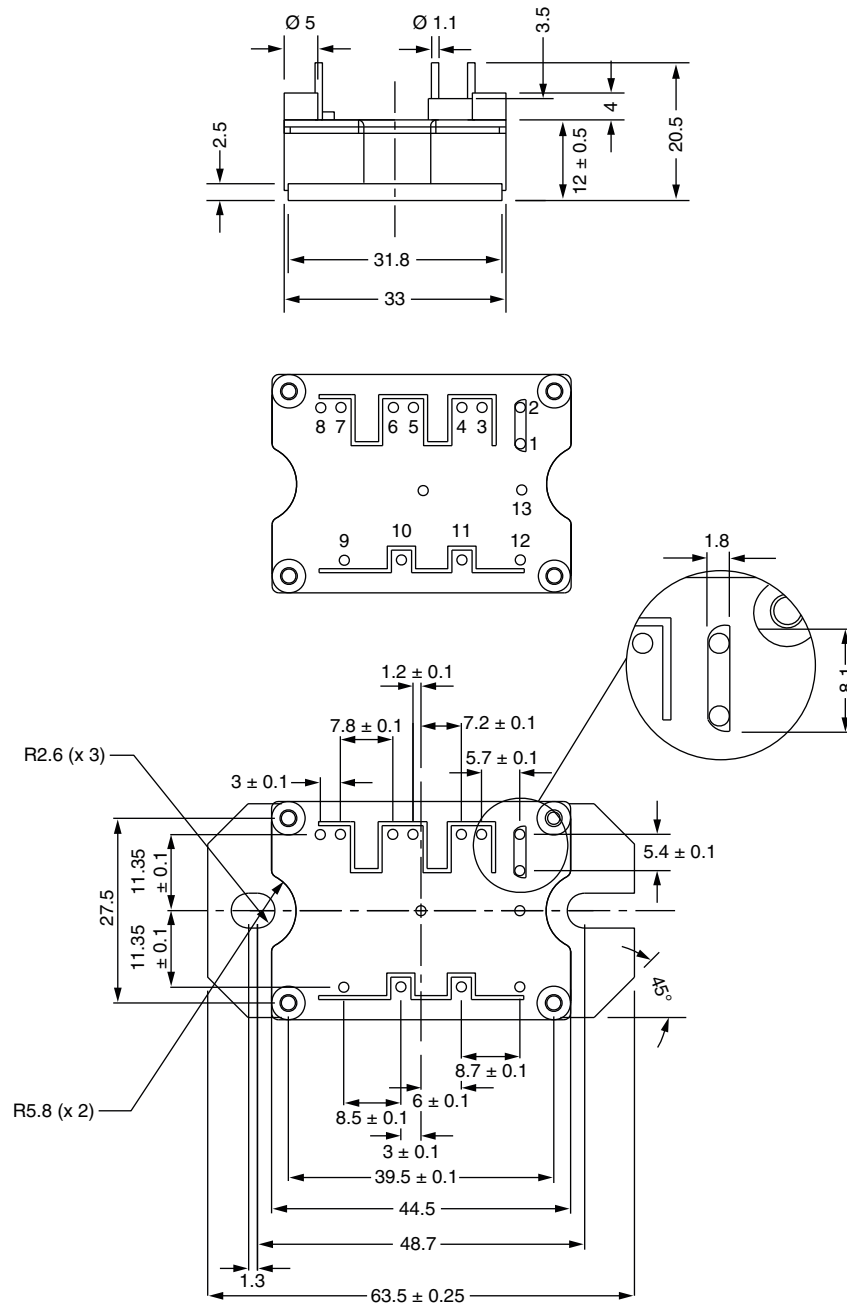
Dimensions

[www.vishay.com/doc?95175](http://www.vishay.com/doc?95175)



## MTP

**DIMENSIONS** in millimeters



**Note**

- Unused terminals are not assembled in the package



## Disclaimer

ALL PRODUCT, PRODUCT SPECIFICATIONS AND DATA ARE SUBJECT TO CHANGE WITHOUT NOTICE TO IMPROVE RELIABILITY, FUNCTION OR DESIGN OR OTHERWISE.

Vishay Intertechnology, Inc., its affiliates, agents, and employees, and all persons acting on its or their behalf (collectively, "Vishay"), disclaim any and all liability for any errors, inaccuracies or incompleteness contained in any datasheet or in any other disclosure relating to any product.

Vishay makes no warranty, representation or guarantee regarding the suitability of the products for any particular purpose or the continuing production of any product. To the maximum extent permitted by applicable law, Vishay disclaims (i) any and all liability arising out of the application or use of any product, (ii) any and all liability, including without limitation special, consequential or incidental damages, and (iii) any and all implied warranties, including warranties of fitness for particular purpose, non-infringement and merchantability.

Statements regarding the suitability of products for certain types of applications are based on Vishay's knowledge of typical requirements that are often placed on Vishay products in generic applications. Such statements are not binding statements about the suitability of products for a particular application. It is the customer's responsibility to validate that a particular product with the properties described in the product specification is suitable for use in a particular application. Parameters provided in datasheets and/or specifications may vary in different applications and performance may vary over time. All operating parameters, including typical parameters, must be validated for each customer application by the customer's technical experts. Product specifications do not expand or otherwise modify Vishay's terms and conditions of purchase, including but not limited to the warranty expressed therein.

Except as expressly indicated in writing, Vishay products are not designed for use in medical, life-saving, or life-sustaining applications or for any other application in which the failure of the Vishay product could result in personal injury or death. Customers using or selling Vishay products not expressly indicated for use in such applications do so at their own risk. Please contact authorized Vishay personnel to obtain written terms and conditions regarding products designed for such applications.

No license, express or implied, by estoppel or otherwise, to any intellectual property rights is granted by this document or by any conduct of Vishay. Product names and markings noted herein may be trademarks of their respective owners.

## Material Category Policy

**Vishay Intertechnology, Inc. hereby certifies that all its products that are identified as RoHS-Compliant fulfill the definitions and restrictions defined under Directive 2011/65/EU of The European Parliament and of the Council of June 8, 2011 on the restriction of the use of certain hazardous substances in electrical and electronic equipment (EEE) - recast, unless otherwise specified as non-compliant.**

**Please note that some Vishay documentation may still make reference to RoHS Directive 2002/95/EC. We confirm that all the products identified as being compliant to Directive 2002/95/EC conform to Directive 2011/65/EU.**

**Vishay Intertechnology, Inc. hereby certifies that all its products that are identified as Halogen-Free follow Halogen-Free requirements as per JEDEC JS709A standards. Please note that some Vishay documentation may still make reference to the IEC 61249-2-21 definition. We confirm that all the products identified as being compliant to IEC 61249-2-21 conform to JEDEC JS709A standards.**