

Eaton Current Limiting Fuses



3.1	Product Overview	
	Product Description	V14-T3-2
3.2	Fuse Selection	
	Fuse Selection	V14-T3-5
	Current Limiting Applications	V14-T3-6
3.3	Applications	
	Applications	V14-T3-11
3.4	CLE, HLE, LHLE, AHLE, BHLE, HCL and BHCL Type Fuses	
	CLE, HLE, LHLE, AHLE, BHLE, HCL and BHCL Type Fuses	V14-T3-19
3.5	CLPT and NCLPT Type Fuses	
	CLPT and NCLPT Type Fuses	V14-T3-42
3.6	ACLS, BCLS, CLS, HCLS and NCLS Type Fuses	
	ACLS, BCLS, CLS, HCLS and NCLS Type Fuses	V14-T3-50
3.7	CLT Type Fuses	
	CLT Type Fuses	V14-T3-65
3.8	CX, CXI and CXN Type Fuses	
	CX, CXI and CXN Type Fuses	V14-T3-67
3.9	DSL, MDSL and NPL Type Low Voltage Current Limiters	
	DSL, MDSL and NPL Type Low Voltage Current Limiters	V14-T3-76

Current Limiting Fuses



Product Description

Introduction

Eaton's medium voltage fuses provide diverse characteristics that allow them to be used in any application within their practical range. This difference is due to the offering of both expulsion and current-limiting fuses. Expulsion and current-limiting fuses employ different interrupting techniques that cause the criteria with which they are employed to differ. This requires that a different set of questions should be answered when applying expulsion and current-limiting fuses. For this reason, and to avoid confusion, this application data applies only to current-limiting fuses. For information on the application of expulsion fuses see Eaton's Expulsion Fuse Product Focus.

Available Types

Current ANSI/IEEE fuse standards define three types of current-limiting fuses: back-up fuses, general-purpose fuses and full-range fuses. It is important for the user to have an understanding of these definitions to ensure proper application of the fuse.

A **backup current-limiting fuse** is able to safely interrupt all values of fault current from the rated minimum interrupting current up to the rated maximum interrupting current of the fuse.

Although only backup current limiting fuses make a specific reference to a rated minimum interrupting current, general-purpose and full-range define a rated minimum interrupting current in different terms.

The rated minimum interrupting current of a general-purpose fuse is the current that causes the fuse to operate in one hour, and the rated minimum interrupting current of a full-range fuse is the minimum value of current that will melt the fusible element(s) under specified conditions.

Generally, Eaton's backup current-limiting fuses are the R-rated range, which have a rated minimum interrupting current equivalent to the 100 second current on the minimum melting time-current curve. This point is not necessarily the limit of low fault performance, merely the required limit of low fault performance, in line with the normal application practices for this type of fuse,

Contents

Description

	<i>Page</i>
Construction	V14-T3-3
Interruption and Operation	V14-T3-3
Application	V14-T3-4
Mountings	V14-T3-4

which is used for high fault protection of medium voltage motor starters in conjunction with relays and overload contactors.

Eaton's R-rated backup fuses may be thermally damaged or may not operate correctly if subjected to overload currents greater than those shown on the safe overload curves and the rated minimum interrupting current for long times.

A **general-purpose current-limiting fuse** is able to safely interrupt all values of fault current from the current that causes the fuse to operate in one hour or more up to the rated maximum interrupting current of the fuse.

The one hour melting time is with the fuse in a conventional mount, and in a 25°C ambient. Other mountings or ambient conditions may cause the fuse to melt earlier, but this does not alter this rated minimum interrupting current. Eaton's general purpose current-limiting fuses are used to protect circuits feeding transformers and feeders, where there is downstream protection that will operate before the medium voltage general-

purpose fuse is affected by a long term overload. See application notes on feeder and transformer protection for details. Eaton's E-rated general-purpose fuses may be thermally damaged or may not operate correctly if subjected to overload currents greater than those shown on the safe overload curves and the indicated one hour interrupting current for long times.

A **full-range current-limiting fuse** is able to safely interrupt all values of fault from the minimum value of current that will melt the fusible element up to the rated maximum interrupting current under specified conditions.

Eaton's full range current-limiting fuses are used to protect circuits feeding transformers and feeders, where there may not be any effective downstream protection.

Construction

Current-limiting fuses are sometimes referred to as silver-sand fuses. This reference comes from the fact that calibrated pure silver current responsive elements are surrounded by pure silica or quartz sand with controlled grain size that acts as a cooling and absorbing agent when the fuse interrupts a fault. Interruption of a fault by a current-limiting fuse is quiet and completely self contained. In general, pure silver is used for the elements in Eaton current limiting fuses because it provides the ideal mix of physical characteristics. With uniquely designed element constructions for each class, these current limiting fuses offer the highest available ratings in the smallest barrel sizes. All components are housed in a fiberglass reinforced resin tube with plated copper contact caps that are magna-formed onto the housing for optimum strength and filled with high purity silica sand. Blown fuse indication is provided by either a striker pin or a pop-up button. A durable nameplate label provides rating and manufacturer information.

Interruption and Operation

Current limiting fuses operate in two modes, depending on the magnitude of the fault current. The first is operation in the overload mode where the fault current is below the threshold current for the fuse. In this mode, the fuse does not operate during the first major half cycle, and does not limit the magnitude of the fault current. The second is operation in the short-circuit or current-limiting mode where the current is above the threshold current for the fuse. In this mode, the fuse does operate during the first major half cycle, and does limit the magnitude of the fault current.

There is a small overlap zone between the overload and short-circuit modes of operation, where the fuse may or may not act in the current-limiting mode. The performance of the fuse in this zone is dependent on circuit conditions such as the power-factor of the circuit, and the point on wave of the inception of the fault. The threshold value for any particular fuse can be read off the peak let-through (cut-off current) chart. The threshold current is the value of available current in amperes on the horizontal axis that corresponds to the intercept of the individual fuse line and the peak asymmetrical available diagonal line.

In the overload mode, the fuse does not limit the peak value of the current, as in this mode, it carries one or more full half cycles of current before the current responsive element(s) melt open. After the current responsive element(s) melt open, they will arc until they have burnt back far enough to interrupt the overload current and withstand the circuit recovery voltage.

In the short-circuit mode, the fuse element(s) melt almost instantaneously, producing a number of series arcs at the neck points on the elements. The interaction of these series arcs and the constraining medium (typically sand) introduces a rapidly rising resistance into the fault circuit that limits the peak value of the current to a value considerably less than the peak value of the prospective current wave. The stored energy in the circuit causes current to continue to flow through the fuse until it is dissipated and this produces a high arc voltage across the fuse. The fuse changes a high current low power factor circuit into a lower current, higher power factor circuit, and as a result, the current is forced to near zero well before the natural current zero of the circuit. Because the current is forced to zero before the natural current zero of the circuit, the effects of transient recovery voltage of the circuit are reduced because the current and voltage are nearly in phase. Current-limiting fuses are thus relatively insensitive to the transient recovery voltage.

CL Fuse Operation

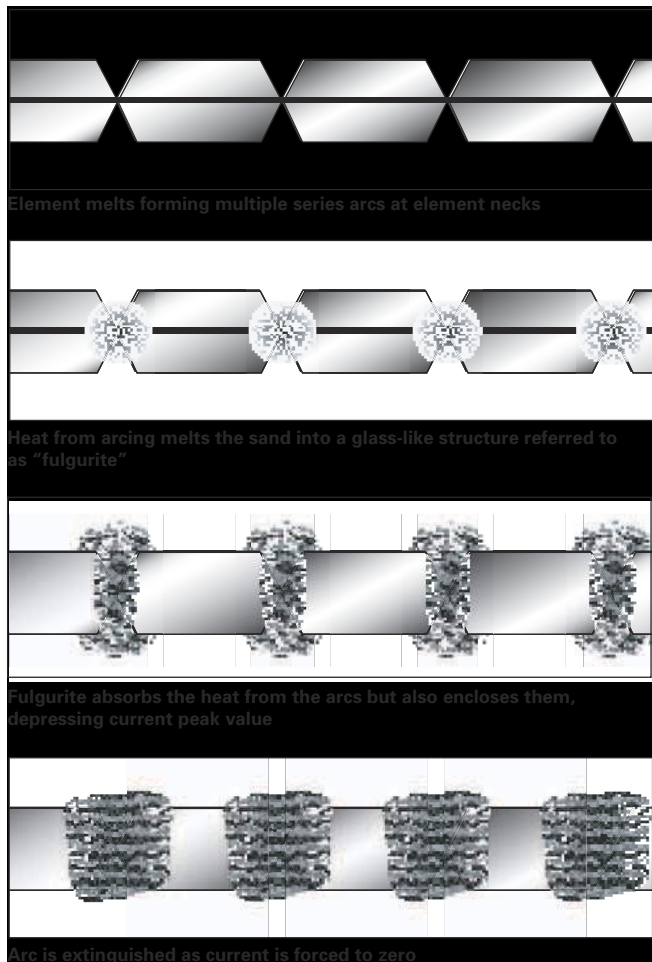

Because of the limitation of the peak value of the current, and the early extinction of the current, the energy let through by the fuse in the short-circuit mode is considerably lower than the energy that would have been let through by the unaltered prospective current wave. This significantly reduces energy let through and can protect the circuit from mechanical and thermal damage that would be caused in the absence of the current-limiting fuse.

Eaton's current-limiting fuses produce arc voltages that are within the limits specified in the applicable C37 standards. The arc voltage is seen on the supply side of the fuse, but is not normally seen on the load-side of the fuse.

Application

Eaton offers a wide range of interrupting ratings in single barrel designs with ratings extended to higher currents in double, triple and quad barrel designs. E-rated fuses are available in both long (CLE) and short (HLE) clip center designs. BHLE and HCL versions are available for bolt-in and clamp in mounting arrangements. R-rated motor starter fuses for standard clip mounting (CLS), are also available with an integral hookey for Eaton's Ampgard™ starter assemblies (ACLS) or bolt-in style mounting (BCLS). CLPT fuses are available for potential transformer protection in several different diameters. CX and CLT fuses are ideally suited for canister applications and available in a wide range of ratings. Low voltage current limiters, MDSL for Magnum and DSL breakers and NPL for network protectors, which are not covered in this catalog, are also available in a variety of current ratings.

Mountings

Eaton's current-limiting fuses are available in industry-standard mounting sizes. Disconnect and non-disconnect mountings are available for most fuse case sizes. Mountings include the base, porcelain or glass polyester insulators and live parts. Live parts, fuse clips and fuse end fittings are also available separately. All Eaton's current-limiting fuses and mountings are easy to install and operate.

Current Limiting Fuses



Contents

Description	Page
Fuse Selection	
Current Limiting Applications	V14-T3-6
Voltage Rating	V14-T3-6
Interrupting Rating	V14-T3-6
Continuous Current Rating	V14-T3-7
Fuse Enclosure Packages	V14-T3-8
Parallel Fuses	V14-T3-8
Coordination	V14-T3-8
Interchangeability	V14-T3-9
Specific Applications	V14-T3-9
Let-Through Current	V14-T3-10
Fuses and Lightning Arresters	V14-T3-10

Fuse Selection

There are four major considerations involved in the selection of a current limiting fuse. The first three considerations are the voltage rating, the interrupting rating and the continuous current rating of the fuse. Proper attention should be given to each of these considerations as improper application in any one area may result in the fuse failing to perform its intended function. The fourth consideration is coordination with line and load side protective equipment that is needed to give selectivity of outage and to prevent premature fuse operation. Each of the four areas is discussed here individually.

Current Limiting Applications

Voltage Rating

The rated maximum power frequency voltage of a current-limiting fuse is the maximum rms value of circuit voltage at which the fuse has been demonstrated to be able to operate with specified circuit fault conditions. A fuse must not be applied at any location where the circuit voltage exceeds the rated maximum power frequency voltage of the fuse.

Voltage ratings of particular fuse types are listed in the appropriate fuse data sheets.

The first rule regarding fuse application is that the fuse selected must have a maximum design voltage rating equal to or greater than the maximum power frequency voltage that will be available in the system in which the fuse is installed under all possible conditions. In most cases this means the maximum design voltage of the fuse must equal or exceed the system maximum line-to-line voltage. The only exception to this rule occurs in distribution systems when fusing single-phase loads connected from line-to-neutral on a four-wire effectively grounded system. Here the fuse maximum design voltage need only exceed the system maximum line-to-neutral voltage providing it is impossible under all fault conditions for the fuse to experience the full line-to-line voltage. When only one phase of a four-wire effectively grounded system is extended beyond the fuse to supply a single-phase load connected from phase-to-neutral, it is acceptable to have the fuse maximum design voltage equal or exceed the system maximum line-to-neutral voltage.

It is good practice that if more than one phase of the system is extended beyond the fuse location, the fuse maximum design voltage should equal or exceed the system maximum line-to-line voltage regardless of how the three-phase system is grounded on the source side of the fuse or how the transformers or loads are connected on the load side of the fuse.

It is a common practice, however, to choose to fuse wye grounded wye transformers on the primary side with fuses with a voltage rating that only exceeds the system line-to-neutral voltage. In most cases this presents no problems but the user should be aware of the remote possibility of a secondary phase-to-phase ungrounded fault that could impose full line-to-line voltage across the fuse.

The interrupting action of current limiting fuses produces arc voltages that can exceed the system voltage. Care must be taken to ensure that these arc voltages do not exceed the insulation level of the system. If the fuse voltage rating is not permitted to exceed 140 percent of the system voltage, the arc voltages will generally not create problems. This 140 percent limit on the voltage rating over system voltage does not restrict the use of a higher rated fuse if the system has a high enough insulation level to withstand the short time application of the arc voltage. Eaton's current limiting fuses are designed so that the arc voltage peak at rated interrupting current is less than three times that of the nominal voltage rating. If the system can withstand this peak the higher rated fuse may be used.

Probably the most common problem created by high arc voltages is the sparking over of lightning arresters. As this is a common problem, it is discussed in detail in the section Fuses and Lightning Arresters.

It should be remembered that in most cases the fuse voltage rating should not exceed the system voltage by more than 40% and under no circumstances may the system voltage exceed the maximum design voltage rating of the fuse. The altitude at which a current-limiting fuse is applied must also be considered. The dielectric strength of air decreases with increases in altitude, necessitating a modification to the voltage rating above 1000m.

Altitude correction factors are listed in Annex B of IEEE Std. C37™.100.1.

Interrupting Rating

The rated maximum interrupting current of a current-limiting fuse is the rms value of the symmetrical AC component of the highest current that the fuse has been demonstrated to be able to successfully interrupt under any possible condition of asymmetry with specified circuit conditions. A fuse must not be applied at any location where the available fault current exceeds the rated maximum interrupting current of the fuse.

In general, current-limiting fuses are not sensitive to higher levels of interrupting current. Interrupting ratings are normally based on market requirements and economic cost or availability of testing facilities.

Interrupting ratings of particular fuse types are listed in the appropriate fuse data sheets.

Asymmetry Factors

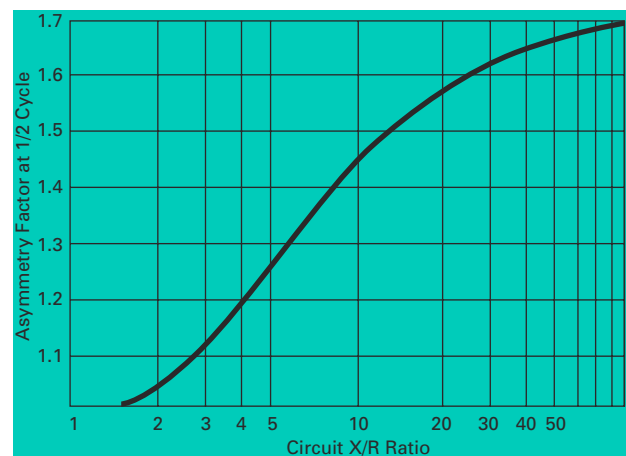

Historically, current limiting fuses had been assigned asymmetrical interrupting ratings and MVA interrupting ratings. Compliance with the test requirements in IEEE Std. C37.41™-2000 for current limiting fuses ensures that Eaton's fuses are tested under peak asymmetry conditions. Fuses are not constant kVA devices; if the circuit voltage is reduced, the interrupting capacity is not increased. The kVA interrupting rating is reduced if the fuse is applied at a lower value of circuit voltage.

The peak asymmetry factor in the first half cycle is a function of the circuit X/R ratio of the circuit, and the relationship is shown on **Page V14-T3-6**. The theoretical maximum value of the asymmetry factor in a purely inductive circuit would be 1.732. However, with the X/R values encountered in power circuits, the factor is rarely more than 1.6.

In the past, fuses were sometimes rated by nominal three-phase kVA ratings. The nominal three-phase kVA rating was calculated by the formula $kVA = I \times kV \times 1.732$, where I is the rated maximum interrupting current in symmetrical rms amperes and kV is the nominal fuse voltage rating.

When a current-limiting fuse interrupts a fault current above its threshold current, it will limit the amplitude of the current in the first major loop. The level of current limitation, measured by the ratio of peak circuit available current to the fuse peak let-through current increases as the value of symmetrical available current increases above the fuse threshold current. In addition to controlling the amplitude of the let-through current, a current-limiting fuse can also cause the current to be extinguished significantly earlier than the natural current zero of the circuit.

The altitude at which a current-limiting fuse is applied must also be considered. The dielectric strength of air decreases with increases in altitude, necessitating a reduced interrupting rating above 1000m (3280 ft).

Altitude correction factors are listed in Annex B of IEEE Std. C37.100.1™.

A general purpose current limiting fuse can have some limits on interrupting low currents. General purpose fuses are fault protective but not overload protective. They do not provide protection for values of overload current in the range of one to two times the fuse continuous current rating.

A back-up current limiting fuse only protects against high values of fault current, and must be applied with another series protective device. For lower values of fault current, below the minimum interrupting current of the fuse, the series protective device must interrupt these lower values of fault current.

Continuous Current Rating

Eaton current limiting fuses have been demonstrated to be able to carry their rated current continuously without exceeding the temperature rise values permitted by C37.40.

Continuous current ratings of particular fuse types are listed in the appropriate fuse data sheets.

Eaton current-limiting fuses have A-, C-, E-, R-, X- or dual E/X-ratings.

An A-rating indicates that the value before the A is the rated continuous current of the fuse.

A C-rating indicates that the value before the C is the rated continuous current of the fuse, and that the calibrated current-responsive element will melt in 1000 seconds at an rms current within the range of 170 to 240% of the rated continuous current.

The C-requirement is specified in ANSI C37.47™.

An E-rating (100E or less) indicates that the value before the E is the rated continuous current of the fuse, and that the calibrated current-responsive element will melt in 300 seconds at an rms current within the range of 200 to 240% of the rated continuous current.

An E-rating (greater than 100E) indicates that the value before the A is the rated continuous current of the fuse, and that the calibrated current-responsive element will melt in 600 seconds at an rms current within the range of 220 to 264% of the rated continuous current.

The E-requirements are specified in ANSI C37.46.

Some Heritage Westinghouse CLE fuses were assigned an X-rating that indicates that the value before the X was the rated continuous current of the fuse, but the fuse design did not satisfy the E-requirements specified above. Other Heritage Westinghouse CLE fuses were assigned dual E- and X-ratings, where the lower value satisfied the E-requirements above, but the fuse could also carry a higher value of continuous current without exceeding the temperature rise values permitted by C37.40, the X-rating.

An R-rated fuse has current responsive elements calibrated to melt between 15 and 35 seconds when subjected to a current of 100 times the R value. These fuses also have temperature rise requirements at specific values of current.

The R-requirement is specified in ANSI C37.46.

E- and X-rated fuses are power class fuses, used in transformer and feeder circuits.

R-rated fuses are power class fuses, and are used specifically in medium voltage motor controllers.

C-rated fuses are distribution class fuses, and are used mainly in transformer circuits.

A-rated fuses can be distribution or power class fuses.

An E- or C-rating only define one gate on the time-current curve of the fuse, and does not imply interchangeability between fuses from different manufacturers.

There are also significant differences between the time-current curves of E-rated current-limiting and E-rated expulsion fuses, both in the low overcurrent and high fault current areas. E-ratings for expulsion fuses generally give a 2:1 ratio of minimum melting current to continuous current rating. However, E-ratings for current-limiting fuses generally give a 1.6 to 1.8 ratio of minimum melting current to continuous current rating.

If the fuse is subjected to a current below the 330, 600, or 1000 second melting current as stated in the E or C fuse definitions, but substantially above the continuous current rating of the fuse for an excessive length of time, a large amount of heat is generated and this may cause damage to the fuse, adversely affecting the fuse integrity or changing the time-current characteristics of the fuse. Specific allowable overload characteristics for general-purpose and full-range current-limiting fuses must not be exceeded under any circumstances. If back-up fuses are properly applied with a suitable low current protection device to clear low fault currents, overloads should not present a problem.

In practice, current-limiting fuses are used to protect circuits feeding transformers, motors and other equipment where overloads and inrush currents are common. Current-limiting fuses have a rather low thermal capacity and cannot carry overloads of the same magnitude and duration as transformers and motors of equal continuous current rating. For this reason, a general fuse application ratio of 1.4:1 fuse continuous current rating to full load current is suggested so the fuse will not operate on acceptable overloads and inrush conditions. This is a general figure for typical applications and that a ratio as low as 1:1 can be used if the system current will never exceed the rated current of the fuse.

In other applications, a higher ratio will be required to prevent the fuse from operating on transformer inrush or motor starting current or from being damaged due to severe overloading. More specific application information can be found in the individual application sections that follow.

Under no circumstances must the fuse continuous current rating be less than continuous load current and that E- and C-rated fuses may not provide protection for currents in the range of one to two times the continuous current rating.

Fuse Enclosure Packages

It is quite common for current-limiting fuses to be mounted in a fuse enclosure package such as a switch in an enclosure that is surrounded by air, or a transformer draw-out well that is mounted in the transformer and surrounded by hot oil. Fuse enclosure package classes are defined in ANSI C37.40.

Due to the elevated ambient temperature produced by these enclosure packages, it is sometimes necessary to derate the continuous current

rating of the fuse. When an Eaton fuse is to be used within an enclosure, be sure to check with the manufacturer of that enclosure and use the suggested current rating or apply the suggested derating factor if one is necessary.

Parallel Fuses

At times it is desirable to have a continuous current rating larger than any single fuse barrel can provide. Higher ratings can be obtained by paralleling fuses. Two, three and four barrel designs are available. Consult Eaton for specific guidance. Under no circumstances should fuses be paralleled unless the paralleling is one of the extensively tested Eaton designs.

Coordination

In addition to selecting a fuse that meets the voltage, interrupting and continuous current requirements for the application, it is also important to ensure that the melting and clearing performance of the fuse protects and coordinates adequately with other circuit components. Eaton publishes minimum melt and total clear time-current characteristics, and minimum melting and total clearing I^2t values to assist with this coordination. The minimum melt curve gives the minimum melting time in seconds of the fusible element(s) at a particular value of symmetrical rms current under specified temperature conditions and without pre-loading. The total clearing curve gives the maximum clearing time in seconds to complete interruption of the circuit at a particular value of symmetrical current under specified conditions. The range between the minimum melting and the total clearing time current curves includes an allowance for manufacturing tolerances, and the arcing time of the fuse after melting. Arcing time is time in seconds lapsing from the melting of the fusible element(s) to the

final interruption of the circuit. The minimum melting and total clearing I^2t values indicate fuse and circuit damage energy values and are used only for fault currents that melt the fuse elements in less than 0.1 second, that is, above the threshold value for the fuse.

As previously mentioned, three types of current-limiting fuses are defined in ANSI/IEEE standards. Full-range fuses will interrupt any value of current from the interrupting rating down to that which will cause the element(s) to melt under specified conditions. General-purpose fuses will interrupt any value of current from the interrupting rating down to a current that will melt the element(s) in one hour under specified conditions. Back-up fuses will interrupt any current from the interrupting rating down to the rated minimum interrupting current. When coordinating using a full-range or general-purpose fuse, it is necessary

to ensure the current does not exceed the fuse overload characteristics. If back-up fuses are used, ensure that another device that will clear fault currents below the minimum interrupting current of the fuse is used.

Proper coordination of current-limiting fuses in the overload mode is ensured by keeping the fuse minimum melting curve above the total clearing curve of any downstream overcurrent protective device, and keeping the fuse total clearing curve beneath the minimum operating curve of any upstream protective equipment. Coordination in the short-circuit zone is achieved by simply using the I^2t values, and keeping the minimum melting I^2t of the fuse above the total clearing I^2t of any downstream protective device, and keeping the total clearing I^2t of the fuse beneath the damage value of the upstream equipment.

Allowable Overload Factors

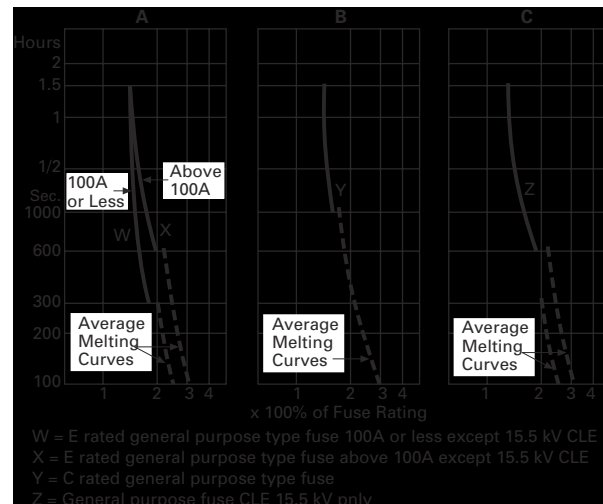

Effects of Ambient Temperature on Melting Curves

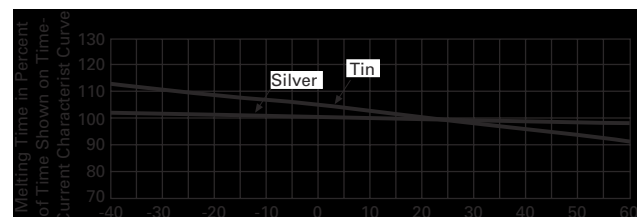

Time-current curves for Eaton's current-limiting fuses are based on standard conditions of temperature and altitude, and the zone between the minimum melting and total clearing characteristics allows for manufacturing tolerances. Preloading and elevated ambient temperatures are not allowed for. It is recommended that a safety zone be used when applying current-limiting fuses to ensure that proper coordination is maintained to allow for these factors. There are two approaches used to achieve this safety zone and both produce similar results. One approach employs a 25% safety zone in time for a given value of current and the other uses a 10% safety zone in current for a given value of time. Eaton uses the second method as it allows the safety zone to be published on the left-hand side of all the time-current curves. Coordination is then achieved by overlaying curves and shifting one by the width of the published safety zone.

If desired or if unusual conditions exist, shifts in the time-current curve due to ambient temperature and preloading may be examined individually. Eaton's time-current characteristics are derived from tests on fuses surrounded by freely circulating air at an ambient temperature of 25°C and with no initial preloading as specified in C37.40. Fuses subjected to conditions other than the above will experience shifts in the time-current curves. The upper right curve gives the adjusting factors for changes in ambient temperature and also the adjusting factors for preloaded fuses. These adjusting factors are valid only for Eaton's power fuses.

The lower right curve gives an example of a properly coordinated fuse application. The figure shows a general-purpose CLE fuse protecting the primary of a 1000 kVA transformer with Eaton's type

DS or Magnum low voltage air circuit breakers protecting the secondary equipment.

Coordination with reclosing circuit breakers may be performed with the aid of the proper coordination chart. This type of curve is explained in the repetitive faults section of the application data.

Interchangeability

C-, E- and R-ratings define the performance of a fuse at one particular point on the time-current curve. However, the fuse performance at other values of current are shown by each manufacturer's published time-current curves. Since these curves are a function of the distinctive current responsive elements used by each manufacturer, fuses with the same C-, E- or R-ratings from different manufacturers may not be interchangeable in all applications. Users must also be aware that E-rated current limiting type and E-rated expulsion type fuses have very different time-current and short circuit characteristics. It is the responsibility of the user to ensure that the physical dimensions and electrical characteristics of the fuse are appropriate for the particular application in the intended equipment.

Specific Applications

There are aspects to be considered other than voltage rating, interrupting rating and continuous current rating. One concerns the types of current-limiting fuses: full-range fuses, general-purpose fuses and back-up fuses. Full-range and general-purpose fuses are normally applied without supplementary protection in the medium voltage system. These fuses are used on transformer and feeder applications. General-purpose fuses are used in power transformer circuits where secondary side protective devices will clear secondary faults. Full-range fuses are used in distribution transformer circuits where

there may not be protection on the secondary side of the transformer and the primary fuse may be called upon to clear a secondary system fault. A back-up fuse must have another medium voltage protective device so that it will not be called upon to interrupt currents below its

specified minimum interrupting rating. An example of a properly applied medium-voltage back-up current-limiting fuse is in a motor starter unit where the CLS fuse is used in series with a relay and contactor to protect it from faults that exceed the contactor rating.

Pre-Loading Adjustment Factors for Power Fuses

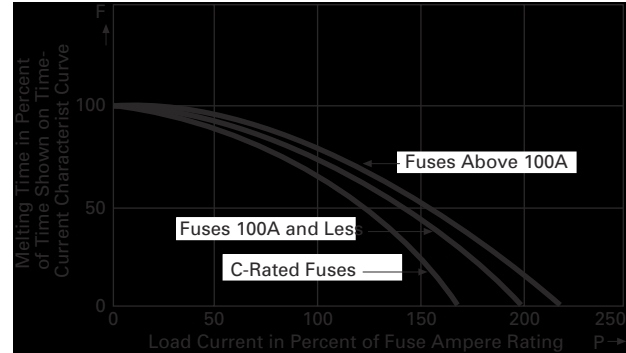

Typical Fuse Coordination

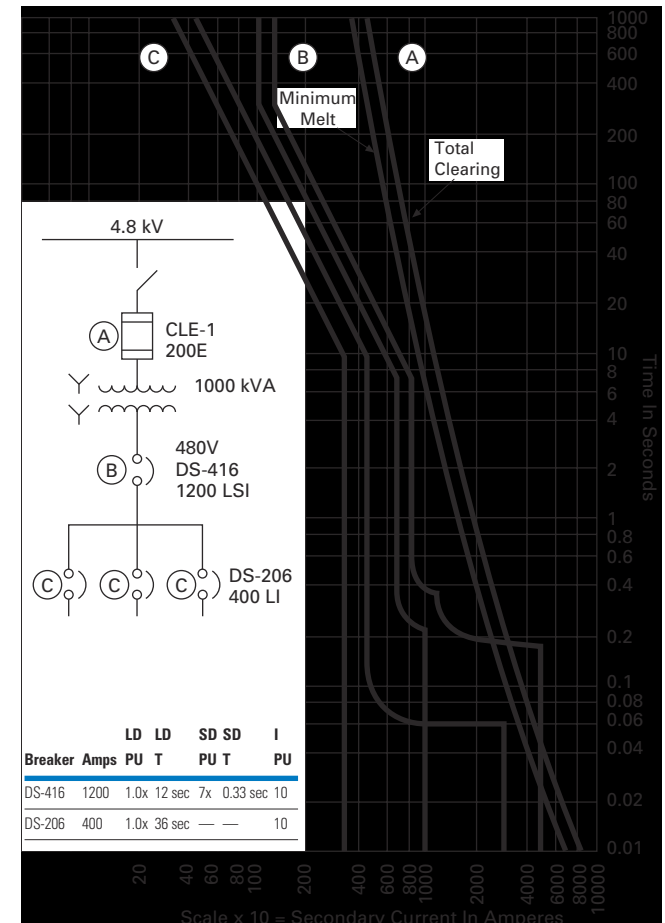

Let-Through Current

An important feature of current-limiting fuses is the limitation of fault current and energy seen by the system being protected. Although a current-limiting fuse is not current-limiting for values of fault current below the threshold current of the fuse, these lower values of fault currents do not present problems due to the low energy. For currents equal to or greater than its threshold current, the fuse will limit the current let-through to the system. The value of this let-through current is dependent on the particular fuse type, the magnitude of the fault current and the timing of the fault initiation—the power

factor of the circuit only has a minimal effect.

If the timing of the fault is such that fuse melts after the current has crested, the fuse will not limit the peak current because the peak has already passed. With a fully asymmetrical fault, the available current would have crested in 1/4 cycle. However, the presence of the fuse in the circuit will limit the peak value of current, and have caused the current to have peaked before the 1/4 cycle time. Thus, the current-limiting action varies with the degree of asymmetry of the fault.

Eaton publishes let-through curves that are based on power circuits with an X/R ratio greater than 15. The curve below shows a typical let-through curve. The horizontal axis gives the rms symmetrical available fault and the vertical axis the peak instantaneous let-through current. Let-through current for any particular fuse may be found by choosing the curve for the fuse in question and reading the let-through for any given value of available fault. The point where the curve intersects the asymmetrical available peak line is the threshold current (for that fuse) or that point where the fuse first become current limiting. Curves like this are found in Eaton's current-limiting fuse application data and make it easy to check the fuse let-through against the withstand of the equipment it is protecting.

into arresters that are not designed for such interrupting duty.

This problem could be eliminated by mounting the fuse on the line side of the arrester, but this is not always practical. Many utilities prefer to apply the fuse on the load side of the arrester to eliminate possible fuse damage that might result from lightning. Other utilities employ transformers with bushing mounted current-limiting fuses where the fuse must be installed on the load side of the arrester.

For current-limiting fuse applied on the load side of a distribution arrester, arc voltages do not affect the arrester if the fuse and the arrester have the same voltage rating; however, if an arrester on the line side has a voltage rating lower than that of the fuse, it may sparkover. Under this condition the arrester and the fuse will share the current. Distribution type arresters have higher impedances that keep them from experiencing excessive amounts of current and they are not usually damaged. Intermediate and station type arresters on the other hand have lower impedances that allow them to experience higher currents and they may become damaged. Therefore, station and line type arresters should not be applied on the line side or in parallel with current-limiting fuses unless their sparkover value is greater than the maximum arc voltage the fuse can produce.

Machine protection arresters are purposely designed to have low sparkover values. They should, however, be connected directly to the machine terminals and not on the line side of the fuse. If properly connected, the fuse arc voltage can have no effect on them.

Correctly applied distribution class lightning arresters found on the line side of the fuse have sparkover values sufficiently high to remain unaffected by fuse operations.

Typical Peak Let-Through Current Curves

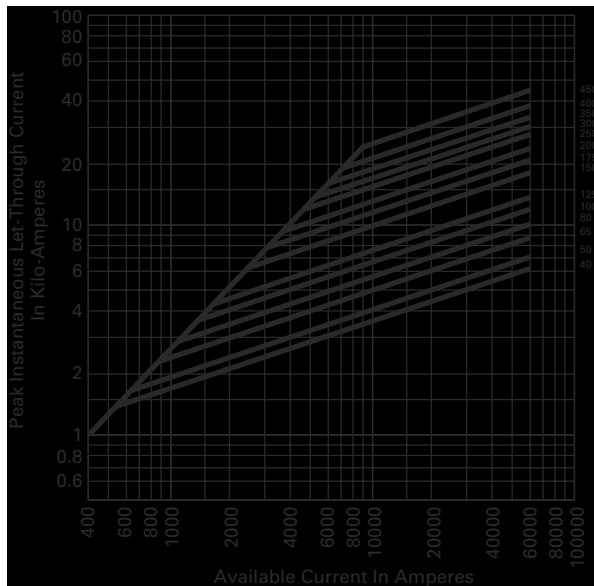

Fuses and Lightning Arresters

Current-limiting fuses generate arc voltages that are higher than the system power frequency voltages. The magnitude of arc voltage generated is dependent on the element design, element length, and the type and size of filler. A strip type element, for example, generates arc voltages that are more dependent on the system voltage, whereas a uniform cross section wire element produces arc voltages dependent on the fault current value. Users of current-limiting fuses are not generally aware of the fuse design so a general estimation of generated arc voltage is needed. Eaton's current-limiting fuses perform their function by generating arc voltages that may peak as high as three times the nominal voltage rating of the fuse at its interrupting rating.

When applying current-limiting fuses, care should be taken to see that arc voltages produced by the fuse do not exceed the insulation level of the system. An examination of the insulation level of the system will show that lightning arresters are the principal equipment to check. If arc voltages cause interconnected lightning arresters to operate, a relatively high current would be shunted

CLPT Fuses



Contents

Description	Page
Applications	
Potential and Control Transformer Application	V14-T3-16
Motor Protection	V14-T3-16
Repetitive Faults	V14-T3-17

Applications

Transformer Applications

Fuses are installed on the primary side of a transformer to:

- Protect the system on the source side of the fuses from an outage due to faults in or beyond the transformer (isolate a faulted transformer from an otherwise healthy distribution system to prevent further disturbance). In the case of an internal winding fault in the transformer, the fuse should prevent further collateral damage to the transformer and its surroundings. Current-limiting fuses are generally better able to limit internal damage to the transformer than expulsion fuses
- Coordinate with protection on the low voltage side of the transformer (transformer primary protection must be overload tolerant, allowing the secondary protection to clear faults occurring downstream of the secondary protection)
- Protect the transformer against bolted secondary faults (the fuse should operate on any bolted secondary faults between the transformer secondary terminals and the

secondary protection before the transformer is damaged)

- Protect the transformer against higher impedance secondary faults to whatever extent is possible (the fuse should limit damage to the transformer windings to the best extent possible)

Selecting the proper voltage and interrupting ratings for the fuse is straightforward and has been sufficiently covered in their respective sections.

There are two sometimes conflicting factors when selecting a fuse to protect a transformer circuit. The continuous current rating must be large enough to prevent premature fuse interruption from magnetizing or inrush currents and it must also be large enough to prevent fuse deterioration or fuse interruption during normal or emergency overload situations. The fuse continuous current rating must also be small enough to provide the protection listed in the purpose hierarchy. In practice, it is not always possible to select a fuse large enough to allow for all the overloading required and still

provide complete protection for the transformer. In these cases, the user should decide how the priorities lie and trade off overloading ability for transformer protection.

Fuses on the primary side of transformers should not operate on transformer magnetizing inrush current. The magnitude of the first loop of inrush current and the rate at which the peaks of subsequent loops decay is a function of many factors. Some of these are transformer design, residual flux in the core at the instant of energization, the point on the voltage wave at which the transformer is energized, and the characteristics of the source supplying the transformer. When energizing, the heating effect of the inrush current in a fuse can be considered equal to 12 times the transformer full load current flowing for 1/10 of a second. Thus, when selecting the current rating for fuses used at the primary side of a transformer, the fuse minimum-melting curve must lie above and to the right of the point on the time-current curve corresponding to 12 times full load current and 0.1 second. The fuse whose minimum melting

curve lies just above and to the right of this point is the lowest rated fuse that can be used at the primary terminals to satisfy the inrush requirements. This criterion is often satisfied for all Eaton's fuses if the fuse current rating is equal to or greater than the transformer self-cooled full load current.

System operators frequently overload their transformers for short periods of time during normal and emergency situations. To allow this flexibility, it is necessary to select a fuse that can carry the overload without being deteriorating.

To accommodate these overloads, a fusing ratio higher than 1:1 is almost always required when applying fuses for transformer protection. The fuse emergency overload curve (**Page V14-T3-8**) and the required extent of overloading is used to determine the smallest fuse that can be applied. Determine the minimum fuse rating by using the duration (ordinate) of the transformer overload on the fuse overload curve (**Page V14-T3-8**) to obtain a the multiple of current rating that should not be exceeded. Divide the transformer overload current by the multiple obtained from the overload curve—the result is the minimum fuse current rating. Select the fuse with a continuous current rating that equals or is just larger than this value. The allowable time duration of the current in the primary side fuses during transformer overload should never exceed the values shown by the fuse overload curve on **Page V14-T3-8**.

Note: Short term and long term overloading of transformers will adversely affect the service life of the transformer. Also, increasing the primary fuse size to allow for higher overloads decreases the protection afforded the transformer. The extent to which transformers are overload, and the implications for system security are economic decisions that are taken by the system operator.

Suggested minimum fuse sizes for protection of self-cooled transformers are given in the table on **Page V14-T3-15**. These tables are based on the premise that the maximum 1.5 hour overload on the transformer would not exceed 200 percent of the transformer rating. This overload condition requires that the minimum ratio of fuse current rating to transformer full load current is 1.4:1. Fuse sizes listed in the table on **Page V14-T3-15** are those that are just higher than 1.4 times the transformer full load current. If higher or longer duration transformer overloads are to be permitted, a fuse with a higher continuous current rating may be required. The procedure described above should then be used to find the smallest permissible fuse size.

If provisions are made by thermal or other protective devices to limit transformer overloads to a lower range, the ratio of fuse current to transformer full load current can be less than 1.4:1. To find the amount of reduction permissible without damage to the fuse, the procedure using the overload curve should be used.

When the transformer has forced cooling, the minimum fuse size that can be applied that be based on the transformer top rating and the extent to which the transformer will be overloaded beyond the top rating.

It should be remembered that E-rated current limiting fuses applied at the primary terminals of a transformer might not provide protection for currents between one and two times the continuous current rating of the fuse. That is, for currents in this range that exceed the time limits shown by the fuse overload curve on **Page V14-T3-8** under the heading “Coordination”. Fuses subjected to such overloads may suffer from undetectable deterioration before the fusible element melts. In order to provide dependable overload protection for the transformer, protection must be applied on the secondary side of the transformer.

Equal concern should be given to the upper limit of continuous current rating that will provide protection for the transformer. The extent to which the fuses are to protect the transformer against secondary faults is one of several factors that determines the upper limit.

When a main secondary breaker is not used, the primary fuses may be the only devices that provide thru-fault protection for the transformer. In these circumstances the fuse should operate before the transformer windings are damaged due to the heavy currents. The capability of transformer windings to carry

these thru-fault or heavy currents varies from one transformer design to another. When specific information applicable to individual transformers is not available, the transformer heat curves given on **Page V14-T3-14** can be used to evaluate the thru-fault protection offered the transformer by the fuses. The curve labeled N=1 is drawn through the points defined in IEEE/ANSI Appendix C57.92, Section 92-06.200 such that the curve has the same shape as shown in Figure 1 of IEEE publication 273 titled, Guide for Protective Relay Application to Power Transformers. This curve applies to single-phase transformers and to three-phase faults on three phase transformer banks. Curves for values of N other than 1 apply to unsymmetrical faults on three-phase transformers and three-phase transformer banks that have at least one delta-connected winding. Ideally, the total clearing time-current of the primary fuse would lie below the heat curve for all values of current up to 25 times the transformer rated current. However, this is not usually possible as the fuse has minimum limitations placed on the rating due to long time overload impressed on the transformer and the fact that E-rated expulsion fuses do not provide protection for currents below two times their continuous current rating. In spite of these lower limitations, primary side fuses should protect the transformer for bolted secondary faults and higher impedance secondary faults to whatever extent is possible.















Wye connected transformers tied to the system neutral or floating have line currents that are equal to the winding currents for faults external to the transformer, regardless of whether the neutral is or is not grounded. Thus a fuse connected to the terminal of a wye-connected winding will see the same current that is in the winding for all faults external to the transformer. Also, there is a simple relation between the primary and secondary amperes, whether load or fault currents are being considered.

This is not the case when the transformer has a delta-connected winding, either on the primary or secondary side of the transformer. With delta-connected primary windings, the current in the lines (fuses) supplying the delta winding and currents in the primary delta windings generally are not equal, and of greater importance the ratio of line (fuse) current to winding current varies with the type of fault on the external system. With delta connected secondary windings, the current in the transformer secondary windings is generally not equal to the secondary line current, and the ratio of primary line current to the secondary line current varies with the type of fault on the secondary system.

The relationship between rated line (fuse) current and rated winding current (referred to, as the “base current of the winding” in IEEE/ANSI Std. C57™.12.00 is 1 for wye connected primaries and is $\sqrt{3}$ for delta-connected primaries. IEEE/ANSI Std. C57™.12.00 also indicates that the transformer winding shall be capable of withstanding 25 times rating winding current for two seconds and smaller multiples of rated winding current for longer periods of time. However, transformer overloads and faults are generally expressed in terms of line and not winding current. This could present a problem for fault conditions where the type of fault changes the relationship between the line and winding current (see the table below) gives a multiplier that will translate the line current in multiples of the winding current for different type faults for various transformer windings. This table leads us back to the transformer heat curves shown on **Page V14-T3-14** where it can be verified that the curve $N=1$ passes through the point 25 times full load line current and two seconds. The curves for other than $N=1$ are for unsymmetrical faults as can be seen from the table below.

Coordination diagrams employ the transformer heat curves and fuse time-current curves to determine which fuse rating may be safely applied. These diagrams are the tools used to apply the information previously cited. The most straight-forward diagram involves fuses applied at the terminals of transformers with wye primary windings. The table below shows that the fuse current is the same as the winding current for all faults external to the transformer. This means the coordination diagram consists simply of the direct reading of the fuse time-current curves and the transformer heat curve $N=1$ for coordination diagrams where the abscissa is labeled in amperes in the primary system. To coordinate with the abscissa labeled in secondary amperes, the same two curves are shifted to allow for the ratio between primary and secondary amperes.

Multiples of Primary Line Current for Fixed Secondary Winding Current

Transformer Connection All Neutrals Grounded		N (N Times Secondary Winding Current Gives Multiples of Primary Line Current)		
Primary	Secondary	Three-Phase Fault	Phase-to-Ground Fault	Phase-to-Phase Fault
		1	 1	 1
		1	... 	1
		1		 $2/\sqrt{3}$
		—	...	

3.3

Current Limiting Fuses

Applications

3

When fuses are employed at the terminals of a delta-wye transformer, the coordination diagram becomes a bit more involved. In this instance the table on **Page V14-T3-13** shows that the fuse current varies in relation to the winding current depending on the nature of the fault. Thus, when the coordination is with respect to primary amperes, the diagram consists of one direct reading fuse time-current curve and one or more transformer heat curves. The number of heat curves included would be determined by the types of secondary faults considered. The table on **Page V14-T3-13** gives the N curve to be used for the different faults to be considered. When the coordination is with respect to secondary amperes, the diagram consists of one transformer heating curve (N=1) and up to three fuse time-current curves. The three time-current curves are again dependent on the possible faults to be considered. The table on **Page V14-T3-13** shows that after the curve is translated to secondary amperes it must be shifted one over the square root of 3 when phase-to-earth faults are considered and two over the square root of 3 when phase-to-phase faults are considered to obtain proper coordination.

Regardless of whether a primary or secondary current abscissa is employed, a coordination diagram for a delta-wye transformer shows that the primary side fuses do not protect the transformer for high-impedance secondary faults and overloads. This type of protection can be obtained through the application of secondary side breakers. If a secondary breaker were used it would be added to the coordination diagram by plotting the breaker phase and ground trip characteristics. Selective coordination would exist if the breaker phase trip characteristic curve lies below the fuse characteristic for a phase-to-phase fault and the heating curve, and the breaker ground trip characteristic for a single line-to-ground fault and the heating curve.

The proceeding pertains to diagrams using secondary amperes. If the breaker characteristic is to be translated to primary amperes, its characteristics must lie beneath the fuse characteristic and the heating curve for N=1. For unsymmetrical faults, the breaker characteristic shifts by the same multiple as the heating curve.

If further secondary protection is translated to the primary, the characteristic must lie beneath the secondary breaker characteristic for the different types of faults considered.

Fuses used at the terminals of a delta-delta transformer require:

1. Fuse time-current.
2. Heating curves if both three-phase and phase-to-phase faults are to be considered.

This agrees with information presented in the table on **Page V14-T3-13**. When the abscissa is in primary amperes, the curves are read directly. An abscissa in secondary amperes uses the same curves but shifts them from primary to secondary amperes.

For all the coordination diagrams just discussed, the vertical distance between the total clearing curve and the safe heat curve indicates the margin of protection offered for different types of faults. It should be remembered, however, that the transformer heat curves illustrated in this application data are drawn from the reference previously cited and they may not apply to all transformer designs.

Typical Transformer Heat Curves

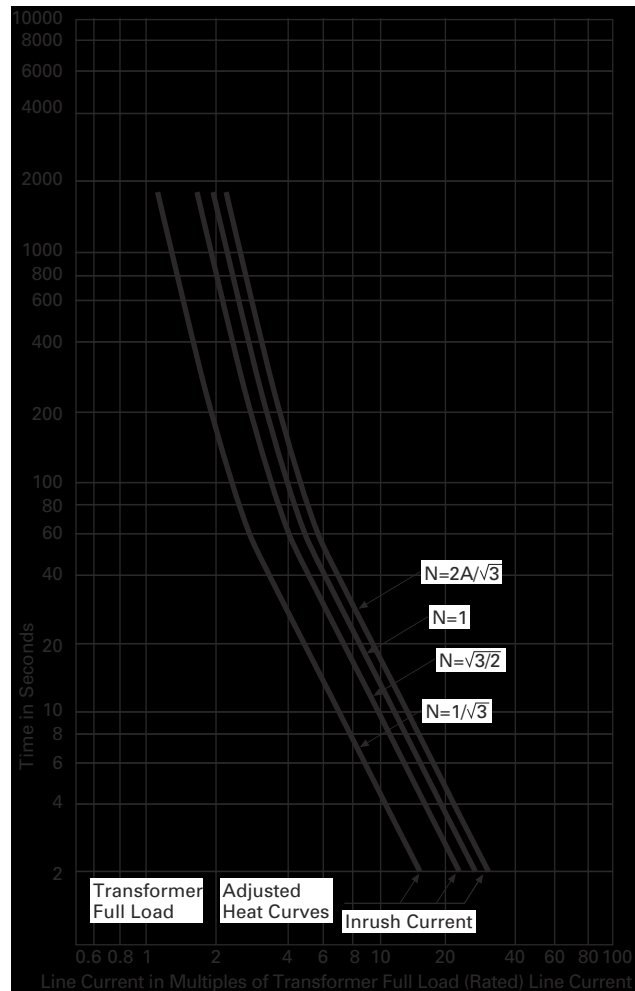

Suggested Minimum Current Limiting Fuse Current Ratings

Self-Cooled 2.4–15.5 kV Power Transformer Applications

System Nominal kV	2.4		4.16		4.8		7.2		12.0		13.2		13.8		14.4	
Fuse Maximum kV	2.75		5.5		5.5		8.3		15.5		15.5		15.5		15.5	
Transformer kVA Rating	Full Load Current	Fuse Rating Amps E or C	Full Load Current	Fuse Rating Amps E or C	Full Load Current	Fuse Rating Amps E or C	Full Load Current	Fuse Rating Amps E or C	Full Load Current	Fuse Rating Amps E or C	Full Load Current	Fuse Rating Amps E or C	Full Load Current	Fuse Rating Amps E or C	Full Load Current	Fuse Rating Amps E or C
Self-Cooled	Amps		Amps		Amps		Amps		Amps		Amps		Amps		Amps	
Three-Phase Transformers																
9	2.2	5E	1.3	3E	1.1	3E	0.7	3E/3.5C	0.4	1E	0.4	1E	0.4	1E	0.4	1E
15	3.6	15E	2.1	3E	1.8	3E	1.2	3E/3.5C	0.7	1E	0.7	1E	0.6	1E	0.6	1E
30	7.2	15E	4.2	10	3.6	5E	2.4	4.5C/5E	1.4	3E/4C	1.3	3E/4C	1.3	1E/4C	1.2	3E/4C
45	10.8	15E/18C	6.2	10	5.4	10	3.6	5E/6C	2.2	4C/5E	2	3C/5E	1.9	3E/4E	1.8	3E/4E
75	18	25	10.4	15	9	15E/18C	6	10	3.6	6C/10E	3.3	5E/6C	3.1	5E/6C	3	5E/6C
112.5	27	40E/45C	15.6	25	13.6	20	9	15	5.4	8C/10E	5	8C/10E	4.7	8C/10E	4.5	8C/10E
150	36	50	20.8	30	18	25	12	18C/20E	7.2	10	6.6	10	6.2	10	6	10
225	54	75C/80E	31.3	45C/50E	27.2	40	18	25	10.8	15	9.9	15	9.4	15	9	15
300	72	100	41.6	60C/65E	36	50	24	35C/40E	14.4	25	13.1	20	12.5	18C/20E	12	18C/20E
500	120	200E	69.4	100	60	100E	40	60C/65E	24.1	40	21.9	30	21	30	20	30
750	180	250E	104	150E	90	125E	60	100	36.1	60C/65E	32.8	45C/50E	31	45C/50E	30.1	45C/50E
1000	241	350E	140	200E	120	200E	80	125	48.1	75C/80E	43.7	60C/55E	42	60C/65E	40.1	60C/65E
1500	360	600E	208	300E	180	250E	120	200	72.2	100	65.6	100	62	100	60.1	100
2000	481	750E	278	400E	241	350E	160	250	96.2	150	87.5	125E/150C	84	125E/150C	80.2	125E/150C
2500	600	1100E	346	600E	301	450E	200	350E	120	200E	109	175	104	175	100	175
Single-Phase Transformers																
5	2.1	5E	1.2	3E	1	1.5E	0.7	3E/3.5C	0.4	1E	0.4	1E	0.4	1E	0.4	1E
10	4.2	15E	2.4	5E	2.1	3E	1.4	3E/3.5C	0.8	1.5E	0.8	1.5E	0.7	1E	0.7	1E
15	6.3	15E	3.6	5E	3.1	5E	2.1	3E/3.5C	1.3	3E/4C	1.1	3E/4C	1.1	3E/4C	1.1	3E/4C
25	10.4	15E	6	10	5.2	10	3.5	5E/6C	2.1	3E/4C	1.9	3E/4C	1.8	3E/4C	1.7	3E/4C
37.5	15.6	25	9	15E/18C	7.8	12C/15E	5.2	8C/10E	3.1	5E/6C	2.8	4C/5E	2.7	4C/5E	2.6	4C/5E
50	20.8	30E/35D	12	20	10.4	15	7	10	4.2	8C/10E	3.8	8C/10E	3.6	8C/10E	3.5	5E/6C
75	31.3	45C/50E	18	25	15.6	25	10.4	15	6.3	10	5.7	8C/10E	5.4	8C/10E	5.2	8C/10E
100	41.7	60C/65E	24	40	20.8	30	13.9	20	8.3	12C/15E	7.6	12C/15E	7.2	12C/15E	6.9	10
167	70	100	40	50	35	50	23.2	40	13.9	20	12.7	18C/20E	12.1	18C/20E	11.6	18C/20E
250	104	150E	60	100E	52.1	80E	34.8	50E/60C	20.8	30	19	30	18.1	30	17.4	30
333	139	200E	80	125E	69.5	100E	46.3	65E/100C	27.7	40	25.2	40	24.1	40	23.1	40
500	208	300E	120	200E	104	150E	39.6	100	41.6	60	38	60C/65E	36.2	60C/65E	34.7	60C/65E
667	278	400E	160	250E	139	200E	92.6	150	55.4	85C/100E	50.5	75C/80E	48.2	75C/80E	46.3	75C/80E
883	347	600E	200	350E	173	250E	115.5	200	69.4	100	63.5	100	60.4	85C/100E	57.8	85C/100E
1250	521	750E	300	450E	260	400E	174	250	104	175	95	150	90.6	150	86.8	125E/150C

Potential and Control Transformer Application

CLPT (CLE-PT) and (N)CLPT type fuses provide protection for the systems to which potential and control power transformers are connected. Like other fuses, (N)CLPT fuses must meet all of the basic selection requirements but there are a couple of differences in the application that will be mentioned here.

Instrument potential transformer fuses are selected on the basis of the transformer magnetizing inrush current instead of the full load current rating. To prevent unnecessary fuse operation, the fuses must have sufficient inrush capacity to safely pass the magnetizing current inrush of the transformer. Fuses should be selected on the basis of the smallest current rating whose minimum melting time-current relationship lies above and to the right of the inrush value.

In some applications these types of transformers are operated in a wye connection at 0.557 times their normal rated voltage. (N)CLPT fuses will usually protect the transformer when applied at this reduced voltage but if the short circuit is through long leads or if the primary voltage is materially decreased by the short circuit on the secondary, the short-circuit current may not be sufficient to operate the fuses.

Motor Protection

Medium voltage motor starters are used to protect medium voltage motor circuits. These starters use overload relays, contactors and back-up current-limiting fuses to provide complete overcurrent protection. The fuses operate to interrupt high values of fault current that exceed the interrupting rating of the contactor and the overload relay operates to open the contactor before the fuse operates for lesser, yet abnormal, currents due to motor overloads, locked rotor, repeated starts, extended accelerating time or low value fault currents. To obtain this coordination, the proper combination of fuse, contactor, current transformer and overload relay must be used to ensure that the contactor operates within its ratings and the fuse for those values of fault current that exceed the contactor's rating. Responsibility for this coordination rests with the manufacturer of the motor starter. In choosing suitable components, the following four areas of protection must be considered:

1. Protection of the motor against sustained overloads and locked rotor conditions by means of the overload relays and contactor;
2. Protection of the fuses against sustained currents above the fuse continuous current ratings and yet below their minimum interrupting value by means of overload relays and contactor;
3. Protection of the circuit by means of the overload relays and contactor for currents within the interrupting limits of the contactor where it is more economic for the contactor to operate rather than the fuses; and
4. Protection of the circuit, contactor, overload relays and current transformers from damaging effects of maximum fault currents by means of properly sized back-up current-limiting fuses that restrict the let-through currents on high current faults to tolerable levels.

The fuses are not protecting the motor itself; they are protecting the system from faults in the motor and motor control circuit.

When selecting a fuse for such a coordinated motor starter scheme, the basic requirements for the fuse in addition to those of adequate voltage and interrupting rating are:

1. The fuse continuous current rating must be equal to or greater than the full load current of the motor;
2. The fuse must have the capacity to carry continuously, without damage, currents less than the pick-up value of the overload relay, but no less than 125% of the motor full load current; and

3. The fuse must have the capacity to carry, without damage, currents greater than the pick-up value of the overload relay but less than the fuse melt and relay overload setting curves for sufficient time to allow the overload relay to operate.
4. The fuse must be selected to allow for the run-up time of the motor, and also for the frequency of starts. It is typical also to select fuses to allow for two consecutive starts.

This is the reason for emphasizing the need to avoid damage to the fuse from long duration overloads such as those caused by locked rotor conditions. Damage can generally be avoided by keeping the melting curve of the fuse above the locked rotor current by a safe margin until it is intersected by the relay curve. A reasonable margin is 10% but the manufacturer's application instructions will state just how close an application is permissible.

Typical Fuse and Motor Starter Coordination

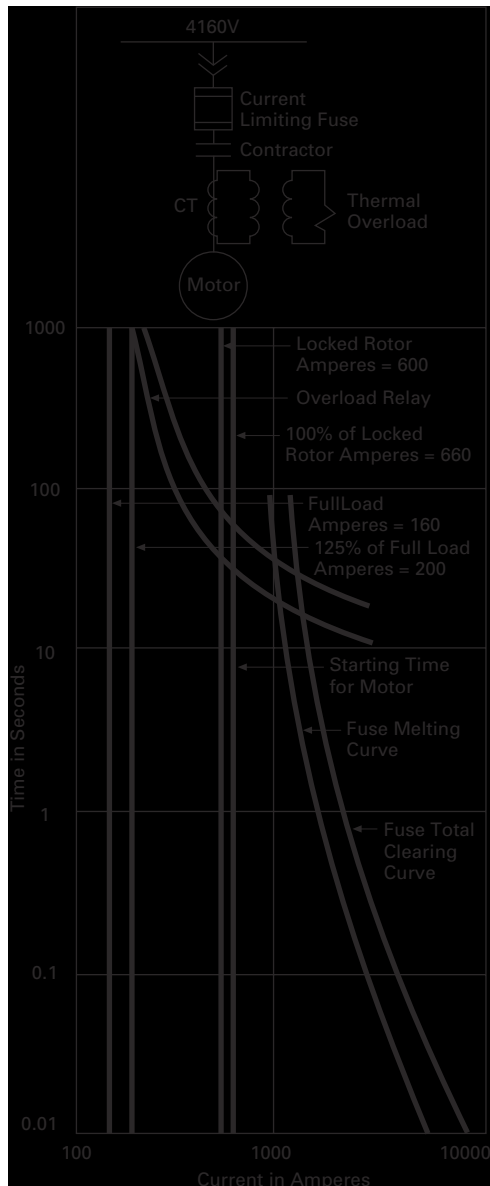

Although it is possible to protect a medium voltage motor circuit with a general-purpose or full-range fuse without a series relay-contactor combination, it is not a common practice for two reasons. First, the melting current of the fuse is approximately twice its rated current. This means that the fuse does not provide protection against anything less than 100% overload, and usually this range is even larger. Second, the damage characteristics of the apparatus and the total clearing time-

current characteristic of the fuse hardly ever coincide. Thus a motor protected only by a general-purpose or full-range fuse may be exposed to overloads of somewhat longer duration than desirable or the fuse may limit the equipment's overload capacity.

As should be obvious, the duty of fuses in motor starter circuits is characterized by the frequent application of high overloads such as motor starting currents and cooling periods while the motor is off. Eaton's CLS fuse has been thoroughly tested to

ensure the fuse is capable of withstanding these frequent and severe heating and cooling cycles. The test consisted of running 2000A through a 24R fuse for 10 seconds, then 400A for 5 minutes and finally cooling the fuse with no current for 5 minutes. This three-step cycle was repeated 3000 times with the fuse showing no deterioration as measured by change in resistance at the conclusion.

To aid in selecting a fuse for motor starter application, the following may prove helpful:

$$\text{Full load current} = \frac{(\text{horsepower}) \cdot (746)}{[(\text{voltage}) \cdot (3 \cdot 5) \cdot (\text{efficiency}) \cdot (\text{PF})]}$$

For general use, a 0.9 for efficiency and a 0.8 for power factor yield the following simple relationship between full load current and horsepower:

$$\text{Full load current} = \frac{(\text{horsepower}) \cdot (0.701)}{(kV)}$$

Again on a general basis, inrush current may be assumed to be six times the full load current for a duration of 15 seconds.

Repetitive Faults

It is often desired to determine the performance of fuses under repetitive faults such as produced by the operation of reclosing circuit breakers. This performance is becoming of increasing interest as a result of the increased application of current limiting fuses on pole type transformers. The performance is determined by graphically simulating the fuse's heating and cooling characteristics that are found in and expressed by the melting time-current curves.

Conventional E- and C-rated fuses can with good approximation be regarded as bodies whose heating and cooling properties are described by the basic exponential Curves A and B as shown in **Page V14-T3-18**. Except for being inverted, the cooling curve is the same as the heating curve as both have

the same time constant. Each fuse has a specific time constant that can be calculated with sufficient accuracy by the formula $t = 0.1 S^2$ where S is the melting current at 0.1 second divided by the melting current at 300,600 or 1000 seconds. The 300 seconds applies for fuses rated 100E amperes or less, the 600 seconds for fuses rated above 100E amperes, and the 1000 seconds for C-rated fuses.

The time constant of a specific fuse, having been obtained in terms of seconds, gives a specific time scale to the general heating and cooling curves of **Page V14-T3-18**. It enables plotting the course of the fuse temperature (in percent values) if the sequence and duration of the open and closed periods of the recloser are known. This is illustrated by curve C that is formed by piecing together the proper sections of Curves A and B.

Next the temperature at which the fuse will melt must be determined. Refer to the standard time-current curves and find the melting time M for a specific value of fault current. The melting temperature T_m lies where the ordinate to the time M intersects curve A. It is not necessary to know the absolute value of this temperature as it is sufficient to know its relation to the peaks. A similar temperature T_n can be found using the total clearing time for the specific fault current. The results are two temperatures where any time the fuse curve C intersects line T_m the fuse could operate and any time it intersects line T_n the fuse will definitely operate. The gap between T_m and T_n indicates the tolerance range as set forth in ANSI and NEMA standards where E- and C-rated fuses are defined.

3.3

Current Limiting Fuses

Applications

3

Temperature Cycle of a Fuse During Reclosing Operation

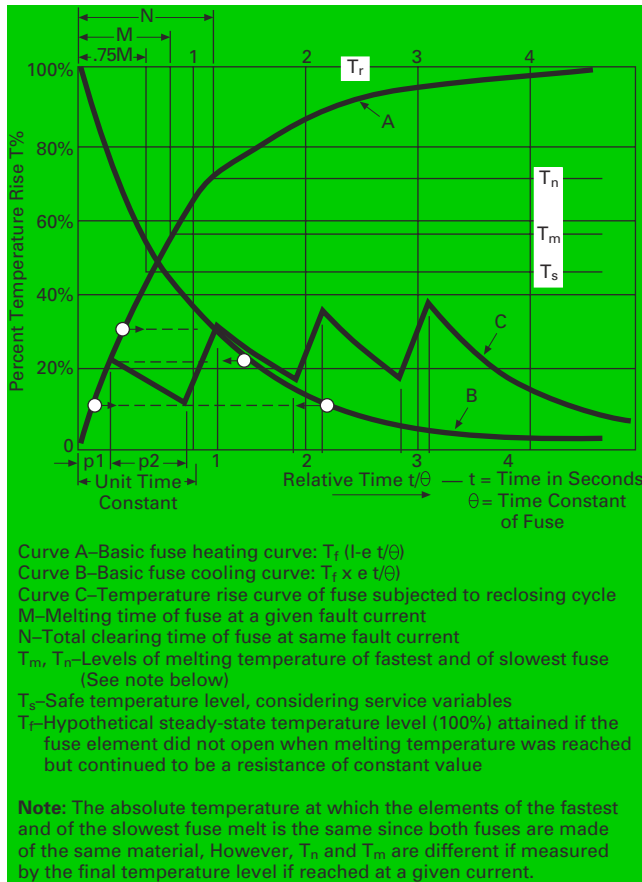

Reclosing Circuit Breaker Fuse Coordination

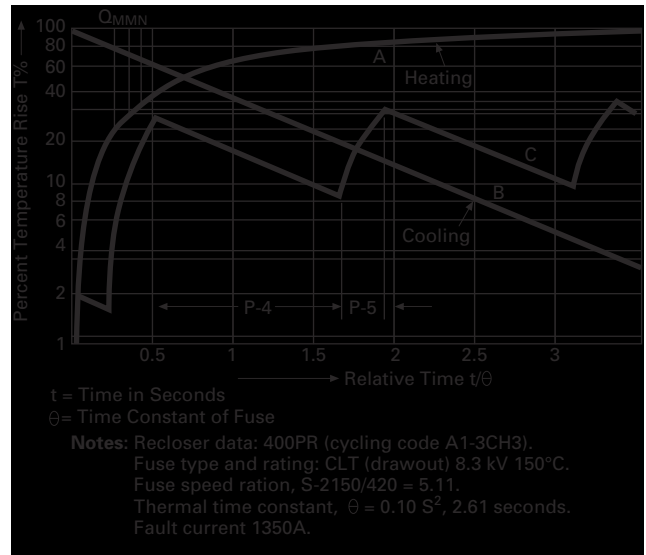

If the fuse is not to operate, curve C must remain below the level T_m by a safe margin. It is common practice to provide such a safety margin by coordinating the breaker with a fuse curve whose time ordinates are 75 percent of those of the melting curve. Line T_s represents this temperature as shown.

Although the construction of the temperature diagram as outlined above basically offers no difficulties, the manipulation is made easier and more accurate by putting the graph on semi-logarithmic coordinates as shown. On these coordinates, the cooling curve B becomes a straight line.

E-Rated Power Fuses



Contents

<i>Description</i>	<i>Page</i>
CLE, HLE, LHLE, AHLE, BHLE, HCL and BHCL Type Fuses	
Catalog Number Selection	V14-T3-21
Ratings and Selection	V14-T3-21
Product Selection	V14-T3-24
CLE Type	V14-T3-24
HLE Type	V14-T3-28
LHLE Type	V14-T3-31
AHLE Type	V14-T3-32
BHLE Type	V14-T3-33
HCL Type	V14-T3-36
Mounting Details	V14-T3-38

CLE, HLE, LHLE, AHLE, BHLE, HCL and BHCL Type Fuses

Product Description

Eaton offers a wide range of interrupting ratings in single barrel designs with ratings extended to higher currents in double, triple and quad barrel designs. E-rated fuses are available in both long (CLE), intermediate (LHLE) and short (HLE) clip center designs.

CLE fuses conform to dimensional standards established in the past by Westinghouse when the original BAL current limiting power fuses for transformer and general feeder applications were introduced.

HLE fuses conform to later, shorter dimensional standards.

BHLE fuses are identical to HLE fuses with the addition of "bolt-in" mounting blades.

HCL fuses are special dimension fuses for "bolt-in" and "clip-lock" mounting blades.

Applications

Helix type (helical element configuration, current limiting) and Heritage CLE type medium voltage fuses are general purpose, indoor fuses designed to provide both high and low level fault protection. Helix fuses may be applied wherever it is necessary to limit short-circuit currents on high capacity systems.

Because of their general purpose, current limiting characteristics, these types of fuses are well suited for a wide variety of distribution systems and consumer applications. Some of the more frequent possibilities are:

- Power transformer protection
- Fused switches
- Feeder circuit sectionalization

Features

Helix Type Fuses

Helix type current limiting fuses, designed for indoor and outdoor applications, are replaceable fuse units with automatic blown fuse indication provided by a striker pin. In addition to giving local indication of fuse condition, the striker pin can be used to trigger an external tripping device. The powerful striker pin delivers approximately three joules of energy over a 5/8-inch travel distance, more than sufficient for mechanical operation of trip-all-phase devices or micro-switches. HLE and CLE type fuses can be mounted in disconnect or non-disconnect mounting configurations. BHLE type fuses can be directly "bolted-in" onto switchgear bus bars. HCL type fuse units are mounted in cam action clip-lock clips for easy installation and replacement.

Helix fuses have a semi-coreless design, enclosed in high strength, filament wound glass and epoxy tubes. They are filled with high purity silica sand of controlled grain size. Fuse elements are pure silver in a double helix configuration to optimize performance by maximizing the number of elements.

The double helix design delivers:

- Higher current ratings
- Cooler operation
- Improved time-current characteristics
- Reduced 12t let-through
- Shorter length

Single, double and triple barrel designs are available to cover a wide range of current, voltage and interrupting ratings. For their sizes, Eaton's helix type fuses offer the highest available E-ratings.

In addition, Eaton's 3-inch diameter fuses will directly replace other manufacturer's fuses.

Heritage Type Fuses

Certain “Heritage” Westinghouse fuse types have been retained where there are no suitable helix type fuses to replace them. These fuses are normally only supplied for replacement purposes. The major items here are the shorter 2-inch diameter 2.75 kV CLE fuses from 15E to 25E and 15.5 kV fuses where the older designs used more parallel barrels than the current Helix design.

The Heritage fuse designs are suitable for indoor use only.

CLE and HLE Features

Helix type current limiting fuses offer a number of advantages over competing current limiting designs. During the selection process, consider the following:

- **Optimized Energy Exchange:** The double concentric helix configuration (inner and outer) optimizes energy exchange by making more efficient use of the sand filler
 - **Improved Arc Control:** The double helix design has more elements for more surface area permitting better arc control
 - **Lower Temperature Rise:** Heat radiation with the HLE design is excellent resulting in lower normal operating temperatures
 - **Promotes Faster Melting:** Under overload conditions, thermal transfer from the inner helix is reduced by a modified temperature gradient leading to faster melting
 - **Blown Fuse Indication:** Blown fuse striker pin will protrude from the top of the fuse providing a visual indication of operation, as well as a triggering means for external devices
 - **Interchangeability:** Helix type fuses are mechanically interchangeable and in many cases have higher maximum current ratings than competing current limiting fuses
 - **Limited Arc Voltage:** Improved limited arc voltage on 40E and higher current rating fuses permits 15.5 kV fuses to be used on 8.3 kV circuits and 8.3 kV fuses to be used on 5.5 kV circuits
- Helix type current limiting fuses also offer additional advantages over other types of fuse designs:
- **Quiet and Safe Operation:** Helix type fuses are sealed static units eliminating the need for externally mounted exhaust control devices
 - **Limits Fault Current:** By design, helix type fuses interrupt high fault currents before the first loop of fault current reaches its natural crest value. The double helix design delivers lower I^2t
 - **Higher Interrupting Capabilities:** Helix type fuses have higher interrupting ratings than expulsion fuses because of their current limiting capabilities
 - **Indoor/Outdoor Application:** Helix type fuse end caps are magneformed to the tube and sealed with resilient RTV sealant

Mounting Hardware

- CLE type and HLE helix type current limiting fuses are designed to be used in either disconnect or non-disconnect mountings
- All CLE and HLE fuse units can be mounted, as supplied, in appropriate non-disconnect mountings. Adding disconnect fuse end fittings to a CLE or HLE fuse unit permits it to be mounted in an appropriate disconnect mounting
- Most HCL current limiting fuse units have blades to enable the fuse to be mounted in cam locking clips
- HCL5-900E and 750E, and BHLE fuses have end blades for direct bolting to custom bus bars or mountings
- AHLE and certain Heritage designs are specifically equipped for mounting in Eaton’s Ampgard motor starter equipment
- Disconnect and non-disconnect live parts above the insulator are available for CLE, HLE and HCL clip-lock fuses

Catalog Number Selection

Helix Fuse Units

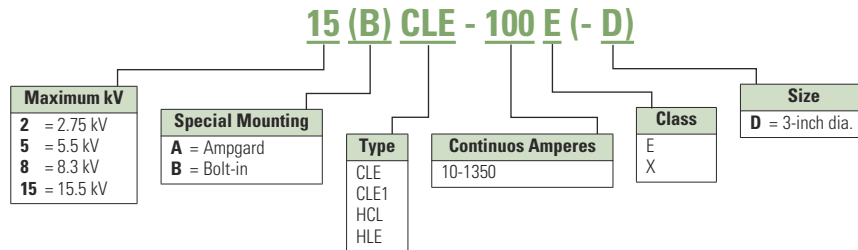

Helix Fuse Mounting

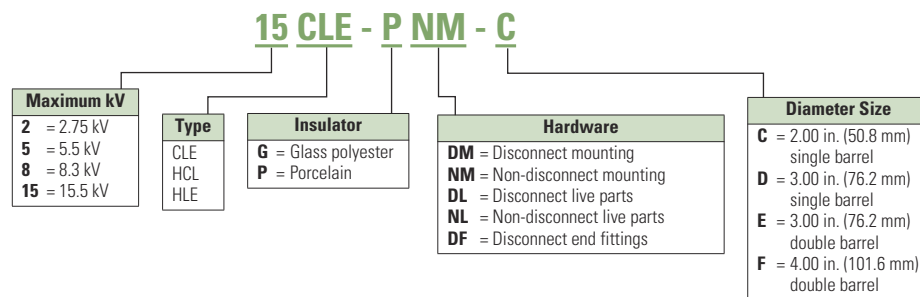

Ratings and Selection

When a decision has been made to use current limiting fuses, the minimum amount of information required to make the proper selection is:

- Voltage rating
- Current rating
- Interrupting rating
- Mounting method:
 - Non-disconnect mounting
 - Disconnect mounting
 - Clip-lock mounting
 - Direct bolt-in mounting
 - Live parts only
 - No required mounting

Refer to tables on **Pages V14-T3-22 to V14-T3-41** for assistance in selecting the correct fuse catalog number.

These types of fuses commonly provide protection for transformer primaries. There are specific rules governing the selection of the required fuse continuous rating. The current limiting fuse application notes earlier in this publication offer suggested minimum current limiting fuse current ratings for self-cooled transformers. The suggested ratings are intended as general guidelines only.

When selecting the appropriate fuse for a new installation, keep in mind that one fuse unit and one compatible mounting is required for each phase.

3.4

Current Limiting Fuses

CLE, HLE, LHLE, AHLE, BHLE, HCL and BHCL Type Fuses

Suggested Minimum Current Limiting Fuse Current Ratings for Self-Cooled 2.4–15.5 kV Transformer Applications—E-Rated Fuses

System Nominal kV	2.4		4.16		4.8		7.2		12.0		13.2		13.8		14.4	
	Fuse Maximum kV	2.75	5.5	5.5	8.3	15.5	15.5	15.5	15.5	15.5	15.5	15.5	15.5	15.5	15.5	15.5
Transformer kVA Rating Self-Cooled	Full Load Current Amps	Fuse Rating Amps E	Full Load Current Amps	Fuse Rating Amps E	Full Load Current Amps	Fuse Rating Amps E	Full Load Current Amps	Fuse Rating Amps E	Full Load Current Amps	Fuse Rating Amps E	Full Load Current Amps	Fuse Rating Amps E	Full Load Current Amps	Fuse Rating Amps E	Full Load Current Amps	Fuse Rating Amps E
Three-Phase Transformer																
9	2.2	5E ^①	1.3	3E ^①	1.1	3E ^①	0.7	3E ^①	0.4	1E ^①	0.4	1E ^①	0.4	1E ^①	0.4	1E ^①
15	3.6	10E ^①	2.1	3E ^①	1.8	3E ^①	1.2	3E ^①	0.7	1.5E ^①	0.7	1E ^①	0.6	1E ^①	0.6	1E ^①
30	7.2	15E	4.2	10E	3.6	10E	2.4	5E ^①	1.4	3E ^①	1.3	3E ^①	1.3	3E ^①	1.2	3E ^①
45	10.8	20E	6.2	10E	5.4	10E	3.6	10E	2.2	5E ^①	2.0	3E ^①	1.9	3E ^①	1.8	3E ^①
75	18.0	30E	10.4	15E	9.0	15E	6.0	10E	3.6	10E	3.3	5E ^①	3.1	5E ^①	3.0	5E ^①
112.5	27.1	50E	15.6	25E	13.5	20E	9.0	15E	5.4	10E	4.9	10E	4.7	10E	4.5	10E
150	36.1	65E	20.8	30E	18.0	30E	12.0	20E	7.2	15E	6.6	10E	6.3	10E	6.0	10E
225	54.1	80E	31.2	50E	27.1	50E	18.0	30E	10.8	20E	9.8	15E	9.4	15E	9.0	15E
300	72.2	125E	41.6	80E	36.1	65E	24.1	40E	14.4	25E	13.1	20E	12.6	20E	12.0	20E
500	120.3	200E	69.4	125E	60.1	100E	40.1	65E	24.1	50E	21.9	40E	20.9	40E	20.0	40E
750	180.4	300E	104.1	150E	90.2	150E	60.1	100E	36.1	65E	32.8	65E	31.4	65E	30.1	65E
1000	240.6	350E	138.8	200E	120.3	175E	80.2	125E	48.1	80E	43.7	80E	41.8	80E	40.1	80E
1500	360.8	600E ^{②③}	208.2	300E	180.4	300E	120.3	175E	72.2	125E	65.6	100E	62.8	100E	60.1	100E
2000	481.1	750E ^{②③}	277.6	400E	240.6	350E	160.4	250E	96.2	150E	87.5	150E	83.7	150E	80.2	125E
2500	601.4	1100E ^{②③}	347.0	600E ^③	300.7	450E	200.5	300E	120.3	200E	109.3	175E	104.6	175E	100.2	175E
Single-Phase Transformer																
5	2.08	3E ^①	1.20	3E ^①	1.04	1.5E ^①	0.69	3E ^①	0.42	1E ^①	0.38	1E ^①	0.36	1E ^①	0.35	1E ^①
10	4.17	10E	2.40	5E ^①	2.08	3E ^①	1.39	3E ^①	0.83	1.5E ^①	0.76	1.5E ^①	0.72	1.5E ^①	0.69	1.5E ^①
15	6.25	10E	3.61	10E	3.13	5E ^①	2.08	3E ^①	1.25	3E ^①	1.14	3E ^①	1.09	3E ^①	1.04	3E ^①
25	10.42	15E	6.01	10E	5.21	10E	3.47	5Ev	2.08	5E ^①	1.89	3E ^①	1.81	3E ^①	1.74	3E ^①
37.5	15.63	25E	9.01	15E	7.81	15E	5.21	10E	3.13	5E	2.84	5E ^①	2.72	5E ^①	2.60	5E ^①
50	20.83	40E	12.02	20E	10.42	15E	6.94	10E	4.17	10E	3.79	10E	3.62	10E	3.47	10E
75	31.25	50E	18.03	30E	15.63	25E	10.42	15E	6.25	10E	5.68	10E	5.43	10E	5.21	10E
100	41.67	65E	24.04	50E	20.83	30E	13.89	20E	8.33	15E	7.58	15E	7.25	15E	6.94	15E
167	69.58	100E	40.14	80E	34.79	65E	23.19	40E	13.92	25E	12.65	20E	12.10	20E	11.60	20E
250	104.17	150E	60.10	125E	52.08	100E	34.72	65E	20.83	40E	18.94	30E	18.12	30E	17.36	30E
333	138.75	200E	80.05	150E	69.38	125E	46.25	80E	27.75	50E	25.23	50E	24.13	40E	23.13	40E
500	208.33	300E	120.19	175E	104.17	150E	69.44	125E	41.67	80E	37.88	65E	36.23	65E	34.72	65E
667	277.92	400E	160.34	250E	138.96	200E	92.64	150E	55.58	100E	50.53	80E	48.33	80E	46.32	80E
883	367.92	600E ^{②③}	212.26	300E	183.96	300E	122.64	175E	73.58	125E	66.89	125E	63.99	100E	61.32	100E
1250	520.83	750E ^{②③}	300.48	450E	260.42	400E	173.61	250E	104.17	175E	94.70	150E	90.58	150E	86.81	150E

Notes

- ① CLPT fuses.
- ② 5CLE fuses.
- ③ Not FM compliant for less flammable transformer liquids.

Eaton Helix Fuse I²t Values

Ampere Rating	Min. Melt	5.5 kV		Min. Melt	8.3 kV		Min. Melt	15.5 kV		
		CLE 63 kA Max. Clear	HLE		CLE 50 kA Max. Clear	HLE		CLE 63 kA Max. Clear	HLE Min. Melt Max. Clear	
10E	720	9000	9000	720	9000	9000	720	9000	720	9000
15E	1600	13,500	13,500	1600	13,500	13,500	1600	13,500	1600	13,500
20E	3000	20,000	20,000	3000	20,000	20,000	3000	20,000	3000	20,000
25E	4500	27,000	27,000	4500	27,000	27,000	4500	27,000	4500	27,000
30E	6500	36,000	36,000	6500	36,000	36,000	6500	36,000	6500	36,000
40E	1000	20,000	20,000	1000	20,000	20,000	1000	20,000	1000	20,000
50E	1500	40,000	40,000	1500	40,000	40,000	1500	40,000	1500	40,000
65E	2600	65,000	65,000	3000	65,000	65,000	2600	65,000	2600	65,000
80E	4300	120,000	120,000	5000	140,000	140,000	5000	140,000	5000	140,000
100E	6400	160,000	160,000	8500	225,000	225,000	8500	225,000	8500	225,000
125E	10,000	200,000	200,000	22,500	275,000	275,000	22,500	270,000	22,500	270,000
150E	36,000	230,000	245,000	30,000	325,000	325,000	42,000	450,000	—	—
175E	53,000	575,000	625,000	48,000	400,000	400,000	—	—	—	—
200E	74,000	600,000	630,000	—	—	—	—	—	—	—
250E	11,500	700,000	900,000	—	—	—	—	—	—	—
150E	—	—	—	—	—	—	—	—	20,000	450,000
175E	—	—	—	—	—	—	22,000	750,000	25,000	750,000
200E	—	—	—	25,000	900,000	900,000	35,000	900,000	34,000	900,000
250E	—	—	—	90,000	1,100,000	1,100,000	100,000	1,000,000	65,000	1,100,000
300E	18,500	1,600,000	1,700,000	145,000	1,300,000	1,300,000	170,000	1,700,000	—	—
350E	225,000	2,000,000	2,100,000	190,000	1,600,000	1,600,000	—	—	—	—
400E	300,000	2,300,000	2,500,000	—	—	—	—	—	—	—
450E	465,000	2,800,000	3,000,000	—	—	—	—	—	—	—

3.4

Current Limiting Fuses

CLE, HLE, LHLE, AHLE, BHLE, HCL and BHCL Type Fuses

Product Selection

CLE Type

3

CLE Type



CLE Type Current Limiting Fuses 2.75 kV Maximum (2.4 kV Nominal)

Current Rating (Amperes)	Barrel Number	Interrupting Rating rms (kA Sym.)	Heritage Product	Indoor/Outdoor	Performance Curves			Catalog Number
					Minimum Melting Time	Total Clearing Time	Peak Let-Through Current	
15E	1	50	H	Indoor	TC56353202	TC56353302	TC63931702	2CLE-15E
20E	1	50	H	Indoor	TC56353202	TC56353302	TC63931702	2CLE-20E
25E	1	50	H	Indoor	TC56353202	TC56353302	TC63931702	2CLE-25E
10E	1	50	H	Indoor	TC53686104	TC53686204	TC63931704	2CLE-10E
30E	1	50	H	Indoor	TC53686104	TC53686204	TC63931704	2CLE-30E
40E	1	50	H	Indoor	TC53686104	TC53686204	TC63931704	2CLE-40E
50E	1	50	H	Indoor	TC53686104	TC53686204	TC63931704	2CLE-50E
65E	1	50	H	Indoor	TC53686104	TC53686204	TC63931704	2CLE-65E
80E	1	50	H	Indoor	TC53686104	TC53686204	TC63931704	2CLE-80E
100E	1	50	H	Indoor	TC53686104	TC53686204	TC63931704	2CLE-100E
125E	1	50	H	Indoor	TC53686104	TC53686204	TC63931704	2CLE-125E
150E	1	50	H	Indoor	TC53686104	TC53686204	TC63931704	2CLE-150E
200E	1	50	H	Indoor	TC53686104	TC53686204	TC63931704	2CLE-200E
225E	1	50	H	Indoor	TC53686104	TC53686204	TC63931704	2CLE-225E
250E	2	50	H	Indoor	TC53690002	TC53690102	TC63931802	2CLE-250E
300E	2	50	H	Indoor	TC53690002	TC53690102	TC63931802	2CLE-300E
350X	2	50	H	Indoor	TC53690002	TC53690102	TC63931802	2CLE-350X
400X	2	50	H	Indoor	TC53690002	TC53690102	TC63931802	2CLE-400X
450X	2	50	H	Indoor	TC53690002	TC53690102	TC63931802	2CLE-450X

CLE Type Mountings and Hardware 2.75 kV Maximum (2.4 kV Nominal)

Ampere Rating	Fuse Mounting Type ①	Voltage BIL (kV)	Diameter	Clip Center	Length	Approximate Shipping Weight Lbs (kg)	Mounting (Including Live Parts, End Fittings) ②		Live Parts (Including End Fittings) ②	End Fittings (Disconnect Only)
							Porcelain Insulator Catalog Number	Glass-Polyester Insulator Catalog Number	Catalog Number	Catalog Number
15E–25E	Non-disconnect	60	2.00 (50.8)	8.13 (206.5)	9.50 (241.3)	2 (0.91)	2CLE-PNM-C	2CLE-GNM-C	CLE-NL-C	—
	Disconnect	60					2CLE-PDM-C	2CLE-GDM-C	CLE-DL-C	CLE-DF-C
10E–250E	Non-disconnect	60	3.00 (76.2)	7.00 (177.8)	10.90 (276.9)	7 (3.18)	2CLE-PNM-D	2CLE-GNM-D	CLE-NL-D	—
	Disconnect	60					2CLE-PDM-D	2CLE-GDM-D	CLE-DL-D	CLE-DF-D
300E–450E	Non-disconnect	60	3.00 (76.2)	7.00 (177.8)	10.90 (276.9)	15 (6.81)	2CLE-PNM-E	2CLE-GNM-E	CLE-NL-E	—
	Disconnect	60					2CLE-PDM-E	2CLE-GDM-E	CLE-DL-E	CLE-DF-E

Fuse Dimensional Details

Approximate Dimensions in Inches (mm)

CLE Type Fuse

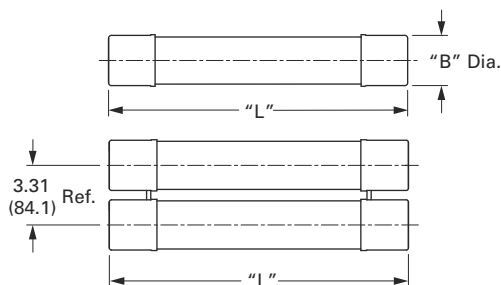

CLE kV	"L"	"B" Dia.
15E–25E	9.50 (241.3)	2.00 (50.8)
10E–450E	10.90 (276.9)	3.00 (76.2)

Notes

- ① See Page V14-T3-38 for diagram of typical mounting.
- ② End fittings supplied only when required.

CLE Type



CLE Type Current Limiting Fuses 5.5 kV Maximum (4.8 kV Nominal)

Current Rating (Amperes)	Barrel Number	Interrupting Rating rms (kA Sym.)	Heritage Product	Indoor/Outdoor	Performance Curves			Catalog Number
					Minimum Melting Time	Total Clearing Time	Peak Let-Through Current	
15E	1	50	H	Indoor	TC56353204	TC56353304	TC63931702	5CLE-15E
20E	1	50	H	Indoor	TC56353204	TC56353304	TC63931702	5CLE-20E
25E	1	50	H	Indoor	TC56353204	TC56353304	TC63931702	5CLE-25E
10E	1	63	—	Indoor/outdoor	TC70548501	TC70548601	TC70548701	5CLE-10E-D
15E	1	63	—	Indoor/outdoor	TC70548501	TC70548601	TC70548701	5CLE-15E-D
20E	1	63	—	Indoor/outdoor	TC70548501	TC70548601	TC70548701	5CLE-20E-D
25E	1	63	—	Indoor/outdoor	TC70548501	TC70548601	TC70548701	5CLE-25E-D
30E	1	63	—	Indoor/outdoor	TC70548501	TC70548601	TC70548701	5CLE-30E
40E	1	50	—	Indoor/outdoor	TC70545801	TC70545901	TC70546701	5CLE-40E
50E	1	50	—	Indoor/outdoor	TC70545801	TC70545901	TC70546701	5CLE-50E
65E	1	50	—	Indoor/outdoor	TC70545801	TC70545901	TC70546701	5CLE-65E
80E	1	50	—	Indoor/outdoor	TC70545801	TC70545901	TC70546701	5CLE-80E
100E	1	50	—	Indoor/outdoor	TC70545801	TC70545901	TC70546701	5CLE-100E
125E	1	50	—	Indoor/outdoor	TC70545801	TC70545901	TC70546701	5CLE-125E
150E	1	63	—	Indoor/outdoor	TC70545801	TC70545901	TC70547601	5CLE-150E
175E	1	63	—	Indoor/outdoor	TC70545801	TC70545901	TC70547601	5CLE-175E
200E	1	63	—	Indoor/outdoor	TC70545801	TC70545901	TC70547601	5CLE-200E
250E	1	63	—	Indoor/outdoor	TC70545801	TC70545901	TC70547601	5CLE-250E
300E	2	63	—	Indoor/outdoor	TC70546001	TC70546101	TC70547601	5CLE-300E
350E	2	63	—	Indoor/outdoor	TC70546001	TC70546101	TC70547601	5CLE-350E
400E	2	63	—	Indoor/outdoor	TC70546001	TC70546101	TC70547601	5CLE-400E
450E	2	63	—	Indoor/outdoor	TC70546001	TC70546101	TC70547601	5CLE-450E
600E	2	40	—	Indoor	TC62908902	TC62908903	TC62908904	5CLE-600E
750E	2	40	—	Indoor	TC62908902	TC62908903	TC62908904	5CLE-750E
1100E	4	31	—	Indoor	TC62908902	TC62908903	TC62908904	5CLE-1100E
1350E	4	31	—	Indoor	TC62908902	TC62908903	TC62908904	5CLE-1350E

CLE Type Mountings and Hardware 5.5 kV Maximum (4.8 kV Nominal)

Ampere Rating	Fuse Mounting Type ①	Voltage BIL (kV)	Diameter Approx. Dimensions in Inches (mm)	Clip Center	Length	Approximate Shipping Weight Lbs (kg)	Mounting (Including Live Parts, End Fittings) ②		Live Parts (Including End Fittings) ②	End Fittings (Disconnect Only)
							Porcelain Insulator Catalog Number	Glass-Polyester Insulator Catalog Number		
10E-D–25E-D 30E–250E	Non-disconnect	60	3.00 (76.2)	14.00 (355.6)	17.90 (454.7)	9 (4.09)	5CLE-PNM-D	5CLE-GNM-D	CLE-NL-D	—
	Disconnect	60	—	—	—	—	5CLE-PDM-D	5CLE-GDM-D	CLE-DL-D	CLE-DF-D
15E–25E	Non-disconnect	60	2.00 (50.8)	11.50 (292.1)	12.90 (327.7)	3 (1.36)	5CLE-PNM-C	5CLE-GNM-C	CLE-NL-C	—
	Disconnect	60	—	—	—	—	5CLE-PDM-C	5CLE-GDM-C	CLE-DL-C	CLE-DF-C
300E–450E	Non-disconnect	60	3.00 (76.2)	14.00 (355.6)	17.90 (454.7)	19 (8.63)	5CLE-PNM-E	5CLE-GNM-E	CLE-NL-E	—
	Disconnect	60	—	—	—	—	5CLE-PDM-E	5CLE-GDM-E	CLE-DL-E	CLE-DF-E
600E and 750E	Consult factory	60	4.00 (101.6)	N/A	N/A	40 (18.16)	—	—	—	—
1100E and 1350E	Consult factory	—	4.00 (101.6)	N/A	N/A	80 (36.32)	—	—	—	—

Fuse Dimensional Details

Approximate Dimensions in Inches (mm)

CLE Type Fuse

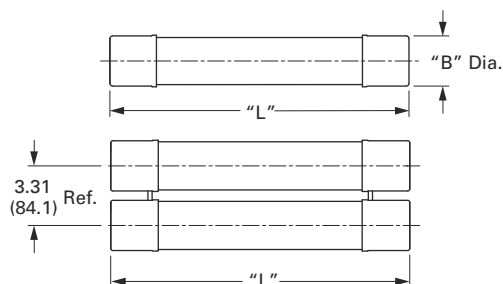

CLE kV	"L"	"B" Dia.
15E–25E	12.90 (327.7)	2.00 (50.8)
10E–450E	17.90 (454.7)	3.00 (76.2)

Notes

- ① See Page V14-T3-38 for diagram of typical mounting.
- ② End fittings supplied only when required.

3.4

Current Limiting Fuses

CLE, HLE, LHLE, AHLE, BHLE, HCL and BHCL Type Fuses

CLE Type



3

CLE Type Current Limiting Fuses 8.3 kV Maximum (7.2 kV Nominal)

Current Rating (Amperes)	Barrel Number	Interrupting Rating rms (kA Sym.)	Heritage Product	Indoor/Outdoor	Performance Curves			Catalog Number
					Minimum Melting Time	Total Clearing Time	Peak Let-Through Current	
15E	1	50	H	Indoor	TC56353204	TC56353304	TC63931703	8CLE-15E
20E	1	50	H	Indoor	TC56353204	TC56353304	TC63931703	8CLE-20E
25E	1	50	H	Indoor	TC56353204	TC56353304	TC63931703	8CLE-25E
10E	1	50	—	Indoor/outdoor	TC70548501	TC70548601	TC70548801	8CLE-10E-D
15E	1	50	—	Indoor/outdoor	TC70548501	TC70548601	TC70548801	8CLE-15E-D
20E	1	50	—	Indoor/outdoor	TC70548501	TC70548601	TC70548801	8CLE-20E-D
25E	1	50	—	Indoor/outdoor	TC70548501	TC70548601	TC70548801	8CLE-25E-D
30E	1	50	—	Indoor/outdoor	TC70548501	TC70548601	TC70548801	8CLE-30E
40E	1	50	—	Indoor/outdoor	TC70546201	TC70546301	TC70547301	8CLE-40E
50E	1	50	—	Indoor/outdoor	TC70546201	TC70546301	TC70547301	8CLE-50E
65E	1	50	—	Indoor/outdoor	TC70546201	TC70546301	TC70547301	8CLE-65E
80E	1	50	—	Indoor/outdoor	TC70546201	TC70546301	TC70547301	8CLE-80E
100E	1	50	—	Indoor/outdoor	TC70546201	TC70546301	TC70547301	8CLE-100E
125E	1	50	—	Indoor/outdoor	TC70546201	TC70546301	TC70547301	8CLE-125E
150E	1	50	—	Indoor/outdoor	TC70546201	TC70546301	TC70547301	8CLE-150E
175E	1	50	—	Indoor/outdoor	TC70546201	TC70546301	TC70547301	8CLE-175E
200E	2	50	—	Indoor/outdoor	TC70546401	TC70546501	TC70547301	8CLE-200E
250E	2	50	—	Indoor/outdoor	TC70546401	TC70546501	TC70547301	8CLE-250E
300E	2	50	—	Indoor/outdoor	TC70546401	TC70546501	TC70547301	8CLE-300E
350E	2	50	—	Indoor/outdoor	TC70546401	TC70546501	TC70547301	8CLE-350E

CLE Type Mountings and Hardware 8.3 kV Maximum (7.2 kV Nominal)

Ampere Rating	Fuse Mounting Type ①	Voltage BIL (kV)	Diameter Approx. Dimensions in Inches (mm)	Clip Center Length	Approximate Shipping Weight Lbs (kg)	Mounting (Including Live Parts, End Fittings) ②		Live Parts (Including End Fittings) ②	End Fittings (Disconnect Only)	
						Porcelain Insulator Catalog Number	Glass-Polyester Insulator Catalog Number	Catalog Number	Catalog Number	
15E-25E	Non-disconnect	75	2.00 (50.8)	14.00 (355.6)	15.50 (393.7)	3 (1.36)	8CLE-PNM-C	8CLE-GNM-C	CLE-NL-C	—
	Disconnect	75					8CLE-PDM-C	8CLE-GDM-C	CLE-DL-C	CLE-DF-C
10E-D-25E-D 30E-175E	Non-disconnect	75	3.00 (76.2)	14.00 (355.6)	17.90 (454.7)	9 (4.09)	8CLE-PNM-D	8CLE-GNM-D	CLE-NL-D	—
	Disconnect	75					8CLE-PDM-D	8CLE-GDM-D	CLE-DL-D	CLE-DF-D
200E-350E	Non-disconnect	75	3.00 (76.2)	14.00 (355.6)	17.90 (454.7)	19 (8.63)	8CLE-PNM-E	8CLE-GNM-E	CLE-NL-E	—
	Disconnect	75					8CLE-PDM-E	8CLE-GDM-E	CLE-DL-E	CLE-DF-E

Fuse Dimensional Details

Approximate Dimensions in Inches (mm)

CLE Type Fuse

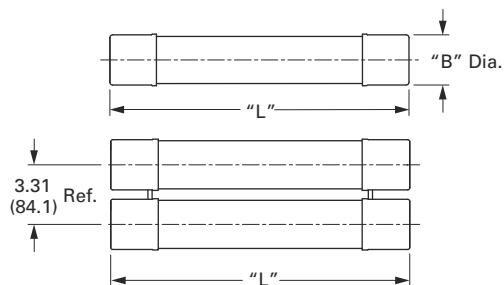

CLE kV	"L"	"B" Dia.
15E-25E	15.50 (393.7)	2.00 (50.8)
10E-350E	17.90 (454.7)	3.00 (76.2)

Notes

- ① See Page V14-T3-38 for diagram of typical mounting.
- ② End fittings supplied only when required.

CLE Type

CLE Type Current Limiting Fuses 15.5 kV Maximum (14.4 kV Nominal)



Current Rating (Amperes)	Barrel Number	Interrupting Rating rms (kA Sym.)	Heritage Product	Indoor/Outdoor	Performance Curves			Catalog Number
					Minimum Melting Time	Total Clearing Time	Peak Let-Through Current	
15E	1	31.5	H	Indoor	TC56353204	TC56353304	TC63931703	15CLE-15E
20E	1	31.5	H	Indoor	TC56353204	TC56353304	TC63931703	15CLE-20E
25E	1	31.5	H	Indoor	TC56353204	TC56353304	TC63931703	15CLE-25E
10E	1	63	—	Indoor/outdoor	TC70548501	TC70548601	TC70548802	15CLE-10E-D
15E	1	63	—	Indoor/outdoor	TC70548501	TC70548601	TC70548802	15CLE-15E-D
20E	1	63	—	Indoor/outdoor	TC70548501	TC70548601	TC70548802	15CLE-20E-D
25E	1	63	—	Indoor/outdoor	TC70548501	TC70548601	TC70548802	15CLE-25E-D
30E	1	63	—	Indoor/outdoor	TC70548501	TC70548601	TC70548802	15CLE-30E
40E	1	63	—	Indoor/outdoor	TC70546801	TC70546901	TC70547501	15CLE-40E
50E	1	63	—	Indoor/outdoor	TC70546801	TC70546901	TC70547501	15CLE-50E
65E	1	63	—	Indoor/outdoor	TC70546801	TC70546901	TC70547501	15CLE-65E
80E	1	63	⓪	Indoor/outdoor	TC70546801	TC70546901	TC70547501	15CLE-80E
100E	1	63	⓪	Indoor/outdoor	TC70546801	TC70546901	TC70547501	15CLE-100E
125E	1	63	⓪	Indoor/outdoor	TC70546801	TC70546901	TC70547501	15CLE-125E
150E	1	63	⓪	Indoor/outdoor	TC70546801	TC70546901	TC70547501	15CLE-150E
175E	2	63	⓪	Indoor/outdoor	TC70547001	TC70547101	TC70547501	15CLE-175E
200E	2	63	⓪	Indoor/outdoor	TC70547001	TC70547101	TC70547501	15CLE-200E
250E	2	63	⓪	Indoor/outdoor	TC70547001	TC70547101	TC70547501	15CLE-250E
300E	2	63	⓪	Indoor/outdoor	TC70547001	TC70547101	TC70547501	15CLE-300E
80E	2	85	H ⓪	Indoor	TC59878302	TC59878402	TC63931604	15CLE2-80E
100E	2	85	H ⓪	Indoor	TC59878302	TC59878402	TC63931604	15CLE2-100E
125X	2	85	H ⓪	Indoor	TC59878302	TC59878402	TC63931604	15CLE2-125X
150E	3	50	H ⓪	Indoor	TC59878302	TC59878402	TC63931604	15CLE3-150E
175E/200X	3	50	H ⓪	Indoor	TC59878302	TC59878402	TC63931604	15CLE3-175E/200X

CLE Type Mountings and Hardware 15.5 kV Maximum (14.4 kV Nominal)

Ampere Rating	Fuse Mounting Type ②	Voltage BIL (kV)	Diameter Approx. Dimensions in Inches (mm)	Clip Center	Length	Approximate Shipping Weight Lbs (kg)	Mounting (Including Live Parts, End Fittings) ②		Live Parts (Including End Fittings) ②	End Fittings (Disconnect Only)
							Porcelain Insulator Catalog Number	Glass-Polyester Insulator Catalog Number	Catalog Number	Catalog Number
15E-25E	Non-disconnect	95	2.00 (50.8)	20.00 (508.0)	21.50 (546.1)	4.5 (2.04)	15CLE-PNM-C	15CLE-GNM-C	CLE-NL-D	—
		110	—	—	—	—	15CLE-HPNM-C	—	—	—
	Disconnect	95	—	—	—	—	15CLE-PDM-C	15CLE-GDM-C	CLE-DL-C	CLE-DF-C
		110	—	—	—	—	15CLE-HPDM-C	—	—	—
10E-D-25E-D 30E-150E	Non-disconnect	95	3.00 (76.2)	20.00 (508.0)	23.90 (607.1)	11 (4.99)	15CLE-PNM-D	15CLE-GNM-D	CLE-NL-D	—
		110	—	—	—	—	15CLE-HPM-D	—	—	—
	Disconnect	95	—	—	—	—	15CLE-PDM-D	15CLE-GNM-D	CLE-DL-D	CLE-DF-D
		110	—	—	—	—	15CLE-HPDM-D	—	—	—
175E-300E	Non-disconnect	110	3.00 (76.2)	20.00 (508.0)	23.90 (607.1)	23 (10.44)	15CLE-PNM-E	—	CLE-DL-E	CLE-DF-E
	Disconnect	110	—	—	—	—	15CLE-PDM-E	—	—	—

Fuse Dimensional Details

Approximate Dimensions in Inches (mm)

CLE Type Fuse

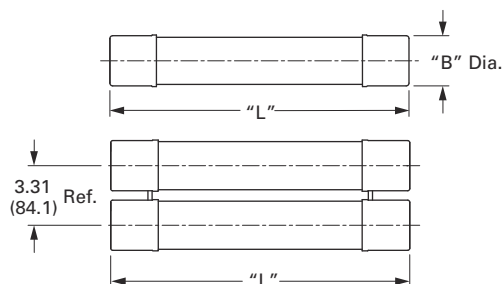

CLE kV	"L"	"B" Dia.
15E-25E	21.50 (546.1)	2.00 (50.8)
10E-300E	23.90 (607.1)	3.00 (76.2)

Notes

- ① For mountings, consult factory.
- ② See Page V14-T3-38 for diagram of typical mounting.
- ③ End fittings supplied only when required.

3.4

Current Limiting Fuses

CLE, HLE, LHLE, AHLE, BHLE, HCL and BHCL Type Fuses

HLE Type

HLE Type

3



HLE Type Current Limiting Fuses 5.5 kV Maximum (4.8 kV Nominal) Interrupting Rating 63 (kA rms Sym.)

Current Rating (Amperes)	Barrel Number	Indoor/Outdoor	Performance Curves			Catalog Number
			Minimum Melting Time	Total Clearing Time	Peak Let-Through Current	
10E	1	Indoor/outdoor	TC70548507	TC70548607	TC70548703	5HLE-10E
15E	1	Indoor/outdoor	TC70548507	TC70548607	TC70548703	5HLE-15E
20E	1	Indoor/outdoor	TC70548507	TC70548607	TC70548703	5HLE-20E
25E	1	Indoor/outdoor	TC70548507	TC70548607	TC70548703	5HLE-25E
30E	1	Indoor/outdoor	TC70548507	TC70548607	TC70548703	5HLE-30E
40E	1	Indoor/outdoor	TC70545805	TC70545905	TC70547603	5HLE-40E
50E	1	Indoor/outdoor	TC70545805	TC70545905	TC70547603	5HLE-50E
65E	1	Indoor/outdoor	TC70545805	TC70545905	TC70547603	5HLE-65E
80E	1	Indoor/outdoor	TC70545805	TC70545905	TC70547603	5HLE-80E
100E	1	Indoor/outdoor	TC70545805	TC70545905	TC70547603	5HLE-100E
125E	1	Indoor/outdoor	TC70545805	TC70545905	TC70547603	5HLE-125E
150E	1	Indoor/outdoor	TC70545805	TC70545905	TC70547603	5HLE-150E
175E	1	Indoor/outdoor	TC70545805	TC70545905	TC70547603	5HLE-175E
200E	1	Indoor/outdoor	TC70545805	TC70545905	TC70547603	5HLE-200E
250E	1	Indoor/outdoor	TC70545805	TC70545905	TC70547603	5HLE-250E
300E	2	Indoor/outdoor	TC70546005	TC70546105	TC70547603	5HLE-300E
350E	2	Indoor/outdoor	TC70546005	TC70546105	TC70547603	5HLE-350E
400E	2	Indoor/outdoor	TC70546005	TC70546105	TC70547603	5HLE-400E
450E	2	Indoor/outdoor	TC70546005	TC70546105	TC70547603	5HLE-450E

HLE Type Mountings and Hardware 5.5 kV Maximum (4.8 kV Nominal)

Ampere Rating	Fuse Mounting Type ①	Voltage BIL (kV)	Diameter Approx. Dimensions in Inches (mm)	Clip Center Length Approx. Dimensions in Inches (mm)	Approximate Shipping Weight Lbs (kg)	Mounting (Including Live Parts, End Fittings) ②		Live Parts (Including End Fittings) ②	End Fittings (Disconnect Only)	
						Porcelain Insulator Catalog Number	Glass-Polyester Insulator Catalog Number	Catalog Number	Catalog Number	
10E–250E	Non-disconnect	60	3.00 (76.2)	12.00 (304.8)	15.90 (403.9)	8 (3.63)	5HLE-PNM-D	5HLE-GNM-D	CLE-NL-D	—
	Disconnect	60					5HLE-PDM-D	5HLE-GDM-D	CLE-DL-D	CLE-DF-D
300E–450E	Non-disconnect	60	3.00 (76.2)	12.00 (304.8)	15.90 (403.9)	17 (7.72)	5HLE-PNM-E	5HLE-GNM-E	CLE-NL-E	—
	Disconnect	60					5HLE-PDM-E	5HLE-GDM-E	CLE-DL-E	CLE-DF-D

Fuse Dimensional Details

Approximate Dimensions in Inches (mm)

HLE Type Fuse

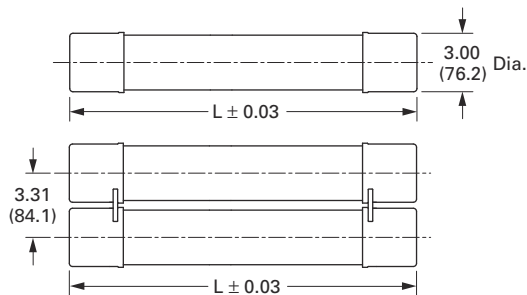

HLE kV	L ± 0.03
5.5	15.88 (403.4)

Notes

- ① See Page V14-T3-38 for diagram of typical mounting.
- ② End fittings supplied only when required.

HLE Type



HLE Type Current Limiting Fuses 8.3 kV Maximum (7.2 kV Nominal) Interrupting Rating 50 (kA Sym.)

Current Rating (Amperes)	Barrel Number	Indoor/Outdoor	Performance Curves			Catalog Number
			Minimum Melting Time	Total Clearing Time	Peak Let-Through Current	
10E	1	Indoor/outdoor	TC70548507	TC70548607	TC70548804	8HLE-10E
15E	1	Indoor/outdoor	TC70548507	TC70548607	TC70548804	8HLE-15E
20E	1	Indoor/outdoor	TC70548507	TC70548607	TC70548804	8HLE-20E
25E	1	Indoor/outdoor	TC70548507	TC70548607	TC70548804	8HLE-25E
30E	1	Indoor/outdoor	TC70548507	TC70548607	TC70548804	8HLE-30E
40E	1	Indoor/outdoor	TC70546203	TC70546303	TC70547201	8HLE-40E
50E	1	Indoor/outdoor	TC70546203	TC70546303	TC70547201	8HLE-50E
65E	1	Indoor/outdoor	TC70546203	TC70546303	TC70547201	8HLE-65E
80E	1	Indoor/outdoor	TC70546203	TC70546303	TC70547201	8HLE-80E
100E	1	Indoor/outdoor	TC70546203	TC70546303	TC70547201	8HLE-100E
125E	1	Indoor/outdoor	TC70546203	TC70546303	TC70547201	8HLE-125E
150E	1	Indoor/outdoor	TC70546203	TC70546303	TC70547201	8HLE-150E
175E	1	Indoor/outdoor	TC70546203	TC70546303	TC70547201	8HLE-175E
200E	2	Indoor/outdoor	TC70546403	TC70546503	TC70547201	8HLE-200E
250E	2	Indoor/outdoor	TC70546403	TC70546503	TC70547201	8HLE-250E
300E	2	Indoor/outdoor	TC70546403	TC70546503	TC70547201	8HLE-300E
350E	2	Indoor/outdoor	TC70546403	TC70546503	TC70547201	8HLE-350E

HLE Type Mountings and Hardware 8.3 kV Maximum (7.2 kV Nominal)

Ampere Rating	Fuse Mounting Type ①	Voltage BIL (kV)	Diameter	Clip Center	Length	Approximate Shipping Weight Lbs (kg)	Mounting (Including Live Parts, End Fittings) ②		Live Parts (Including End Fittings) ②	End Fittings (Disconnect Only)
							Porcelain Insulator Catalog Number	Glass-Polyester Insulator Catalog Number	Catalog Number	Catalog Number
10E–175E	Non-disconnect	75	3.00 (76.2)	12.00 (304.8)	15.90 (403.9)	8 (3.63)	8HLE-PNM-D	8HLE-GNM-D	CLE-NL-D	—
	Disconnect	75					8HLE-PDM-D	8HLE-GDM-D	CLE-DL-D	CLE-DF-D
200E–350E	Non-disconnect	75					8HLE-PNM-E	8HLE-GNM-E	CLE-NL-E	—
	Disconnect	75					8HLE-PDM-E	8HLE-GDM-E	CLE-DL-E	CLE-DF-E

Fuse Dimensional Details

Approximate Dimensions in Inches (mm)

HLE Type Fuse

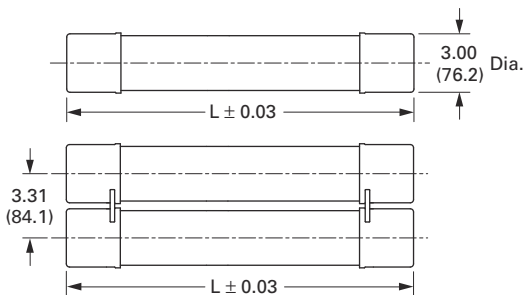

HLE kV	L ± 0.03
8.3	15.88 (403.4)

Notes

- ① See Page V14-T3-38 for diagram of typical mounting.
- ② End fittings supplied only when required.

3.4

Current Limiting Fuses

CLE, HLE, LHLE, AHLE, BHLE, HCL and BHCL Type Fuses

HLE Type

HLE Type Current Limiting Fuses 15.5 kV Maximum (14.4 kV Nominal)



3

Current Rating (Amperes)	Barrel Number	Interrupting Rating rms (kA Sym.)	Indoor/Outdoor	Performance Curves			Catalog Number
				Minimum Melting Time	Total Clearing Time	Peak Let-Through Current	
10E	1	63	Indoor/outdoor	TC70548507	TC70548607	TC70548805	15HLE-10E
15E	1	63	Indoor/outdoor	TC70548507	TC70548607	TC70548805	15HLE-15E
20E	1	63	Indoor/outdoor	TC70548507	TC70548607	TC70548805	15HLE-20E
25E	1	63	Indoor/outdoor	TC70548507	TC70548607	TC70548805	15HLE-25E
30E	1	63	Indoor/outdoor	TC70548507	TC70548607	TC70548805	15HLE-30E
40E	1	63	Indoor/outdoor	TC70546601	TC70546701	TC70547401	15HLE-40E
50E	1	63	Indoor/outdoor	TC70546601	TC70546701	TC70547401	15HLE-50E
65E	1	63	Indoor/outdoor	TC70546601	TC70546701	TC70547401	15HLE-65E
80E	1	63	Indoor/outdoor	TC70546601	TC70546701	TC70547401	15HLE-80E
100E	1	63	Indoor/outdoor	TC70546601	TC70546701	TC70547401	15HLE-100E
125E	1	63	Indoor/outdoor	TC70546601	TC70546701	TC70547401	15HLE-125E
150E	2	63	Indoor/outdoor	TC70546601	TC70546701	TC70547401	15HLE-150E
175E	2	63	Indoor/outdoor	TC70546601	TC70546701	TC70547401	15HLE-175E
200E	2	63	Indoor/outdoor	TC70546601	TC70546701	TC70547401	15HLE-200E
250E	2	63	Indoor/outdoor	TC70546601	TC70546701	TC70547401	15HLE-250E

HLE Type Mountings and Hardware 15.5 kV Maximum (14.4 kV Nominal)

Ampere Rating	Fuse Mounting Type ①	Voltage BIL (kV)	Diameter Approx. Dimensions in Inches (mm)	Clip Center Approx. Dimensions in Inches (mm)	Length Approx. Dimensions in Inches (mm)	Approximate Shipping Weight Lbs (kg)	Mounting (Including Live Parts, End Fittings) ②		Live Parts (Including End Fittings) ②	End Fittings (Disconnect Only)
							Porcelain Insulator Catalog Number	Glass-Polyester Insulator Catalog Number	Catalog Number	Catalog Number
10E–175E	Non-disconnect	95	3.00 (76.2)	15.00 (381.0)	18.90 (480.1)	10 (4.54)	15HLE-PNM-D	15HLE-GNM-D	CLE-NL-D	—
	Disconnect	95					15HLE-PDM-D	15HLE-GDM-D	CLE-DL-D	CLE-DF-D
150E–250E	Non-disconnect	95	3.00 (76.2)	15.00 (381.0)	18.90 (480.1)	21 (9.53)	15HLE-PNM-E	—	CLE-NL-E	—
	Disconnect	95					15HLE-PDM-E	—	CLE-DL-E	CLE-DF-E

Fuse Dimensional Details

Approximate Dimensions in Inches (mm)

HLE Type Fuse

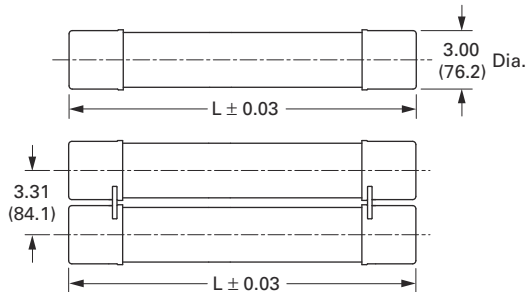

HLE kV	L ± 0.03
15.5	18.88 (479.6)

Notes

- ① See Page V14-T3-38 for diagram of typical mounting.
- ② End fittings supplied only when required.

LHLE Type

LHLE Type



LHLE Type Current Limiting Fuses 15.5 kV Maximum (14.4 kV Nominal) Indoor/Outdoor.

Current Rating (Amperes)	Barrel Number	Approximate Dimensions in Inches (mm)		Approximate Shipping Weight Lbs (kg)	Performance Curves			Catalog Number
		Diameter	Length		Minimum Melting Time	Total Clearing Time	Peak Let-Through Current	
65E	1	3.00 (76.2)	20.53 (521.5)	10.5 (4.80)	TC66703203	TC66703303	TC70547404	15LHLE-65E
80E	1	3.00 (76.2)	20.53 (521.5)	10.5 (4.80)	TC66703203	TC66703303	TC70547404	15LHLE-80E
100E	1	3.00 (76.2)	20.53 (521.5)	10.5 (4.80)	TC66703203	TC66703303	TC70547404	15LHLE-100E
125E	1	3.00 (76.2)	20.53 (521.5)	10.5 (4.80)	TC66703203	TC66703303	TC70547404	15LHLE-125E
150E	1	3.00 (76.2)	20.53 (521.5)	10.5 (4.80)	TC66703203	TC66703303	TC70547404	15LHLE-150E
125E	2	3.00 (76.2)	20.53 (521.5)	21.0 (9.50)	TC66703203	TC66703303	TC70547404	15LHLE2-125E
150E	2	3.00 (76.2)	20.53 (521.5)	21.0 (9.50)	TC66703203	TC66703303	TC70547404	15LHLE2-150E
175E	2	3.00 (76.2)	20.53 (521.5)	21.0 (9.50)	TC66703203	TC66703303	TC70547404	15LHLE-175E
200E	2	3.00 (76.2)	20.53 (521.5)	21.0 (9.50)	TC66703203	TC66703303	TC70547404	15LHLE-200E
250E	2	3.00 (76.2)	20.53 (521.5)	21.0 (9.50)	TC66703203	TC66703303	TC70547404	15LHLE-250E
300E	2	3.00 (76.2)	20.53 (521.5)	21.0 (9.50)	TC66703203	TC66703303	TC70547404	15LHLE-300E

LHLE Type Mountings and Hardware 15.5 kV Maximum (14.4 kV Nominal)

Ampere Rating	Fuse Mounting Type	Diameter Approximate Dimensions in Inches (mm)	Clip Center	Length	Live Parts (Including End Fittings)	End Fittings (Disconnect Only)
					Catalog Number	Catalog Number
65E–150E Single barrel	Non-disconnect	3.00 (76.2)	18.00 (457.0)	20.53 (521.5)	CLE-NL-D	—
	Disconnect				CLE-DL-D	CLE-DF-D
125E–300E Double barrel	Non-disconnect	3.00 (76.2)	18.00 (457.0)	20.53 (521.5)	CLE-NL-E	—
	Disconnect				CLE-DL-E	CLE-DF-E

Fuse Dimensional Details

Approximate Dimensions in Inches (mm)

LHLE Type Fuse

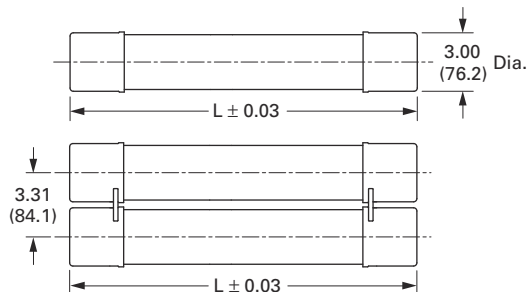

LHLE kV	L ± 0.03
15.5	20.53 (521.5)

3.4

Current Limiting Fuses

CLE, HLE, LHLE, AHLE, BHLE, HCL and BHCL Type Fuses

AHLE Type

5AHLE Type Current-Limiting Fuse Units 5.5 kV Maximum (4.8 kV Nominal)

Current Rating (Amperes)	Barrel Number	Interrupting Rating rms (kA Sym.)	Approximate Shipping Weight Lbs (kg)	Performance Curves			Catalog Number
				Minimum Melting Time	Total Clearing Time	Peak Let-Through Current	
10E	1	63	8 (3.6)	TC70548507	TC70548607	TC70548703	5AHLE-10E
15E	1	63	8 (3.6)	TC70548507	TC70548607	TC70548703	5AHLE-15E
20E	1	63	8 (3.6)	TC70548507	TC70548607	TC70548703	5AHLE-20E
25E	1	63	8 (3.6)	TC70548507	TC70548607	TC70548703	5AHLE-25E
30E	1	63	8 (3.6)	TC70548507	TC70548607	TC70548703	5AHLE-30E
40E	1	63	8 (3.6)	TC70545805	TC70545905	TC70547603	5AHLE-40E
50E	1	63	8 (3.6)	TC70545805	TC70545905	TC70547603	5AHLE-50E
65E	1	63	8 (3.6)	TC70545805	TC70545905	TC70547603	5AHLE-65E
80E	1	63	8 (3.6)	TC70545805	TC70545905	TC70547603	5AHLE-80E
100E	1	63	8 (3.6)	TC70545805	TC70545905	TC70547603	5AHLE-100E
125E	1	63	8 (3.6)	TC70545805	TC70545905	TC70547603	5AHLE-125E
150E	1	63	8 (3.6)	TC70545805	TC70545905	TC70547603	5AHLE-150E
175E	1	63	8 (3.6)	TC70545805	TC70545905	TC70547603	5AHLE-175E
200E	1	63	8 (3.6)	TC70545805	TC70545905	TC70547603	5AHLE-200E
250E	1	63	8 (3.6)	TC70545805	TC70545905	TC70547603	5AHLE-250E
300E	2	63	17 (7.8)	TC70546005	TC70546105	TC70547603	5AHLE-300E
350E	2	63	17 (7.8)	TC70546005	TC70546105	TC70547603	5AHLE-350E
400E	2	63	17 (7.8)	TC70546005	TC70546105	TC70547603	5AHLE-400E
450E	2	63	17 (7.8)	TC70546005	TC70546105	TC70547603	5AHLE-450E

8AHLE Type Current-Limiting Fuse Units 8.3 kV Maximum (7.2 kV Nominal)

Current Rating (Amperes)	Barrel Number	Interrupting Rating rms (kA Sym.)	Approximate Shipping Weight Lbs (kg)	Performance Curves			Catalog Number
				Minimum Melting Time	Total Clearing Time	Peak Let-Through Current	
10E	1	50	8 (3.6)	TC70548507	TC70548607	TC70548804	8AHLE-10E
15E	1	50	8 (3.6)	TC70548507	TC70548607	TC70548804	8AHLE-15E
20E	1	50	8 (3.6)	TC70548507	TC70548607	TC70548804	8AHLE-20E
25E	1	50	8 (3.6)	TC70548507	TC70548607	TC70548804	8AHLE-25E
30E	1	50	8 (3.6)	TC70548507	TC70548607	TC70548804	8AHLE-30E
40E	1	50	8 (3.6)	TC70546203	TC70546303	TC70547201	8AHLE-40E
50E	1	50	8 (3.6)	TC70546203	TC70546303	TC70547201	8AHLE-50E
65E	1	50	8 (3.6)	TC70546203	TC70546303	TC70547201	8AHLE-65E
80E	1	50	8 (3.6)	TC70546203	TC70546303	TC70547201	8AHLE-80E
100E	1	50	8 (3.6)	TC70546203	TC70546303	TC70547201	8AHLE-100E
125E	1	50	8 (3.6)	TC70546203	TC70546303	TC70547201	8AHLE-125E
150E	1	50	8 (3.6)	TC70546203	TC70546303	TC70547201	8AHLE-150E
175E	1	50	8 (3.6)	TC70546203	TC70546303	TC70547201	8AHLE-175E
200E	2	50	17 (7.8)	TC70546403	TC70546503	TC70547201	8AHLE-200E
250E	2	50	17 (7.8)	TC70546403	TC70546503	TC70547201	8AHLE-250E
300E	2	50	17 (7.8)	TC70546403	TC70546503	TC70547201	8AHLE-300E
350E	2	50	17 (7.8)	TC70546403	TC70546503	TC70547201	8AHLE-350E

Note: These fuses are equipped for mounting in Eaton Ampgard motor starting assemblies.

BHLE Type

BHLE Type Current Limiting Fuses 5.5 kV Maximum (4.8 kV Nominal), Indoor, Bolt-In

Current Rating (Amperes)	Barrel Number	Interrupting Rating rms (kA Sym.)	Diameter Approximate Dimensions in Inches (mm)	Length Approximate Dimensions in Inches (mm)	Approximate Shipping Weight Lbs (kg)	Performance Curves			Catalog Number
						Minimum Melting Time	Total Clearing Time	Peak Let-Through Current	
10E	1	63	3.00 (76.2)	15.90 (403.9)	8 (3.63)	TC70548507	TC70548607	TC70548703	5BHLE-10E
15E	1	63	3.00 (76.2)	15.90 (403.9)	8 (3.63)	TC70548507	TC70548607	TC70548703	5BHLE-15E
20E	1	63	3.00 (76.2)	15.90 (403.9)	8 (3.63)	TC70548507	TC70548607	TC70548703	5BHLE-20E
25E	1	63	3.00 (76.2)	15.90 (403.9)	8 (3.63)	TC70548507	TC70548607	TC70548703	5BHLE-25E
30E	1	63	3.00 (76.2)	15.90 (403.9)	8 (3.63)	TC70548507	TC70548607	TC70548703	5BHLE-30E
40E	1	63	3.00 (76.2)	15.90 (403.9)	8 (3.63)	TC70545805	TC70545905	TC70547603	5BHLE-40E
50E	1	63	3.00 (76.2)	15.90 (403.9)	8 (3.63)	TC70545805	TC70545905	TC70547603	5BHLE-50E
65E	1	63	3.00 (76.2)	15.90 (403.9)	8 (3.63)	TC70545805	TC70545905	TC70547603	5BHLE-65E
80E	1	63	3.00 (76.2)	15.90 (403.9)	8 (3.63)	TC70545805	TC70545905	TC70547603	5BHLE-80E
100E	1	63	3.00 (76.2)	15.90 (403.9)	8 (3.63)	TC70545805	TC70545905	TC70547603	5BHLE-100E
125E	1	63	3.00 (76.2)	15.90 (403.9)	8 (3.63)	TC70545805	TC70545905	TC70547603	5BHLE-125E
150E	1	63	3.00 (76.2)	15.90 (403.9)	8 (3.63)	TC70545805	TC70545905	TC70547603	5BHLE-150E
175E	1	63	3.00 (76.2)	15.90 (403.9)	8 (3.63)	TC70545805	TC70545905	TC70547603	5BHLE-175E
200E	1	63	3.00 (76.2)	15.90 (403.9)	8 (3.63)	TC70545805	TC70545905	TC70547603	5BHLE-200E
250E	1	63	3.00 (76.2)	15.90 (403.9)	8 (3.63)	TC70545805	TC70545905	TC70547603	5BHLE-250E
300E	2	63	3.00 (76.2)	15.90 (403.9)	17 (7.72)	TC70546005	TC70546105	TC70547603	5BHLE-300E
350E	2	63	3.00 (76.2)	15.90 (403.9)	17 (7.72)	TC70546005	TC70546105	TC70547603	5BHLE-350E
400E	2	63	3.00 (76.2)	15.90 (403.9)	17 (7.72)	TC70546005	TC70546105	TC70547603	5BHLE-400E
450E	2	63	3.00 (76.2)	15.90 (403.9)	17 (7.72)	TC70546005	TC70546105	TC70547603	5BHLE-450E

Fuse Dimensional Details

Approximate Dimensions in Inches (mm)

5BHLE Type Fuse—Single Barrel

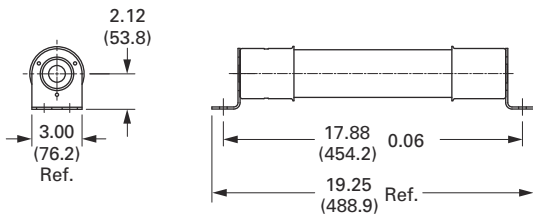

5BHLE Type Fuse—Double Barrel

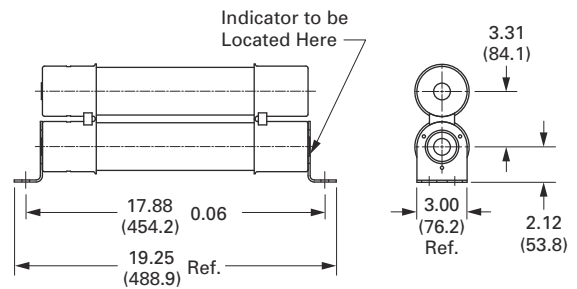

3.4

Current Limiting Fuses

CLE, HLE, LHLE, AHLE, BHLE, HCL and BHCL Type Fuses

3

BHLE Type Current Limiting Fuses 8.3 kV Maximum (7.2 kV Nominal), Indoor, Bolt-In

Current Rating (Amperes)	Barrel Number	Interrupting Rating rms (kA Sym.)	Diameter Approximate Dimensions in Inches (mm)	Length Approximate Dimensions in Inches (mm)	Approximate Shipping Weight Lbs (kg)	Performance Curves		Peak Let-Through Current	Catalog Number
						Minimum Melting Time	Total Clearing Time		
10E	1	50	3.00 (76.2)	15.90 (403.9)	8 (3.63)	TC70548507	TC70548607	TC70548804	8BHLE-10E
15E	1	50	3.00 (76.2)	15.90 (403.9)	8 (3.63)	TC70548507	TC70548607	TC70548804	8BHLE-15E
20E	1	50	3.00 (76.2)	15.90 (403.9)	8 (3.63)	TC70548507	TC70548607	TC70548804	8BHLE-20E
25E	1	50	3.00 (76.2)	15.90 (403.9)	8 (3.63)	TC70548507	TC70548607	TC70548804	8BHLE-25E
30E	1	50	3.00 (76.2)	15.90 (403.9)	8 (3.63)	TC70548507	TC70548607	TC70548804	8BHLE-30E
40E	1	50	3.00 (76.2)	15.90 (403.9)	8 (3.63)	TC70546203	TC70546303	TC70547201	8BHLE-40E
50E	1	50	3.00 (76.2)	15.90 (403.9)	8 (3.63)	TC70546203	TC70546303	TC70547201	8BHLE-50E
65E	1	50	3.00 (76.2)	15.90 (403.9)	8 (3.63)	TC70546203	TC70546303	TC70547201	8BHLE-65E
80E	1	50	3.00 (76.2)	15.90 (403.9)	8 (3.63)	TC70546203	TC70546303	TC70547201	8BHLE-80E
100E	1	50	3.00 (76.2)	15.90 (403.9)	8 (3.63)	TC70546203	TC70546303	TC70547201	8BHLE-100E
125E	1	50	3.00 (76.2)	15.90 (403.9)	8 (3.63)	TC70546203	TC70546303	TC70547201	8BHLE-125E
150E	1	50	3.00 (76.2)	15.90 (403.9)	8 (3.63)	TC70546203	TC70546303	TC70547201	8BHLE-150E
175E	1	50	3.00 (76.2)	15.90 (403.9)	8 (3.63)	TC70546203	TC70546303	TC70547201	8BHLE-175E
200E	2	50	3.00 (76.2)	15.90 (403.9)	17 (7.72)	TC70546403	TC70546503	TC70547201	8BHLE-200E
250E	2	50	3.00 (76.2)	15.90 (403.9)	17 (7.72)	TC70546403	TC70546503	TC70547201	8BHLE-250E
300E	2	50	3.00 (76.2)	15.90 (403.9)	17 (7.72)	TC70546403	TC70546503	TC70547201	8BHLE-300E
350E	2	50	3.00 (76.2)	15.90 (403.9)	17 (7.72)	TC70546403	TC70546503	TC70547201	8BHLE-350E

Fuse Dimensional Details

Approximate Dimensions in Inches (mm)

8BHLE Type Fuse—Single Barrel

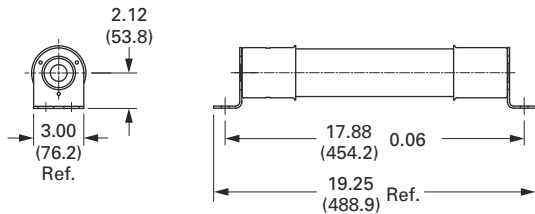

8BHLE Type Fuse—Double Barrel

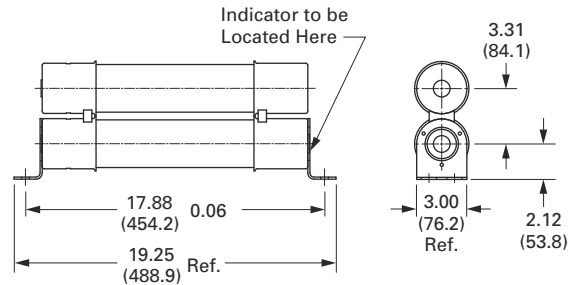

BHLE Type Current Limiting Fuses 15.5 kV Maximum (14.4 kV Nominal), Indoor/Outdoor, Bolt-In

Current Rating (Amperes)	Barrel Number	Interrupting Rating rms (kA Sym.)	Diameter Approximate Dimensions in Inches (mm)	Length Approximate Dimensions in Inches (mm)	Approximate Shipping Weight Lbs (kg)	Performance Curves Minimum Melting Time	Performance Curves Total Clearing Time	Performance Curves Peak Let-Through Current	Catalog Number
10E	1	63	3.00 (76.2)	18.90 (480.1)	10 (4.54)	TC70548507	TC70548607	TC70548805	15BHLE-10E
15E	1	63	3.00 (76.2)	18.90 (480.1)	10 (4.54)	TC70548507	TC70548607	TC70548805	15BHLE-15E
20E	1	63	3.00 (76.2)	18.90 (480.1)	10 (4.54)	TC70548507	TC70548607	TC70548805	15BHLE-20E
25E	1	63	3.00 (76.2)	18.90 (480.1)	10 (4.54)	TC70548507	TC70548607	TC70548805	15BHLE-25E
30E	1	63	3.00 (76.2)	18.90 (480.1)	10 (4.54)	TC70548507	TC70548607	TC70548805	15BHLE-30E
40E	1	63	3.00 (76.2)	18.90 (480.1)	10 (4.54)	TC70546601	TC70546701	TC70547401	15BHLE-40E
50E	1	63	3.00 (76.2)	18.90 (480.1)	10 (4.54)	TC70546601	TC70546701	TC70547401	15BHLE-50E
65E	1	63	3.00 (76.2)	18.90 (480.1)	10 (4.54)	TC70546601	TC70546701	TC70547401	15BHLE-65E
80E	1	63	3.00 (76.2)	18.90 (480.1)	10 (4.54)	TC70546601	TC70546701	TC70547401	15BHLE-80E
100E	1	63	3.00 (76.2)	18.90 (480.1)	10 (4.54)	TC70546601	TC70546701	TC70547401	15BHLE-100E
125E	1	63	3.00 (76.2)	18.90 (480.1)	10 (4.54)	TC70546601	TC70546701	TC70547401	15BHLE-125E
150E	2	63	3.00 (76.2)	18.90 (480.1)	21 (9.53)	TC70546601	TC70546701	TC70547401	15BHLE-150E
175E	2	63	3.00 (76.2)	18.90 (480.1)	21 (9.53)	TC70546601	TC70546701	TC70547401	15BHLE-175E
200E	2	63	3.00 (76.2)	18.90 (480.1)	21 (9.53)	TC70546601	TC70546701	TC70547401	15BHLE-200E
250E	2	63	3.00 (76.2)	18.90 (480.1)	21 (9.53)	TC70546601	TC70546701	TC70547401	15BHLE-250E

Fuse Dimensional Details

Approximate Dimensions in Inches (mm)

15BHLE Type Fuse—Single Barrel

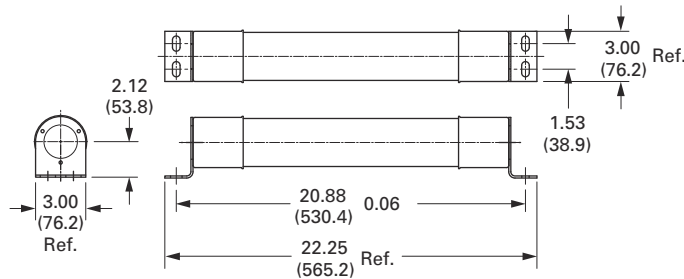

15BHLE Type Fuse—Double Barrel

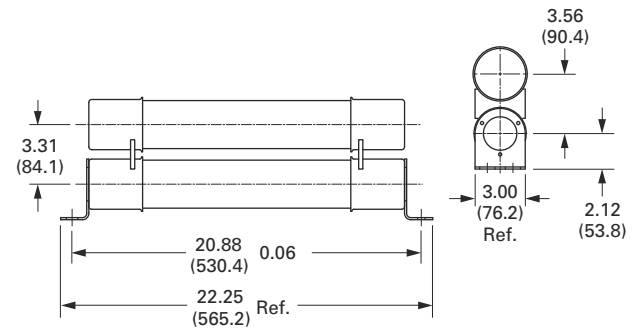

3.4

Current Limiting Fuses

CLE, HLE, LHLE, AHLE, BHLE, HCL and BHCL Type Fuses

HCL Type

HCL Type Current Limiting Fuses 5.5 kV Maximum (4.8 kV Nominal), Indoor

Current Rating (Amperes)	Barrel Number	Interrupting Rating rms (kA Sym.)	Approximate Diameter in Inches (mm)	Clip Center	Approximate Shipping Weight Lbs (kg)	Mounting Type	Live Parts (Includes End Fittings) Catalog Number	Performance Curves			Catalog Number
								Minimum Melting Time	Total Clearing Time	Peak Let-Through Current	
10E	1	63	3.00 (76.2)	Clip-lock	9 (4.09)	Non-disconnect	HCL-NL-1	TC70548505	TC70548605	TC70548702	5HCL-10E
15E	1	63	3.00 (76.2)	Clip-lock	9 (4.09)	Non-disconnect	HCL-NL-1	TC70548505	TC70548605	TC70548702	5HCL-15E
20E	1	63	3.00 (76.2)	Clip-lock	9 (4.09)	Non-disconnect	HCL-NL-1	TC70548505	TC70548605	TC70548702	5HCL-20E
25E	1	63	3.00 (76.2)	Clip-lock	9 (4.09)	Non-disconnect	HCL-NL-1	TC70548505	TC70548605	TC70548702	5HCL-25E
30E	1	63	3.00 (76.2)	Clip-lock	9 (4.09)	Non-disconnect	HCL-NL-1	TC70548505	TC70548605	TC70548702	5HCL-30E
40E	1	63	3.00 (76.2)	Clip-lock	9 (4.09)	Non-disconnect	HCL-NL-1	TC70545803	TC70545903	TC70547602	5HCL-40E
50E	1	63	3.00 (76.2)	Clip-lock	9 (4.09)	Non-disconnect	HCL-NL-1	TC70545803	TC70545903	TC70547602	5HCL-50E
65E	1	63	3.00 (76.2)	Clip-lock	9 (4.09)	Non-disconnect	HCL-NL-1	TC70545803	TC70545903	TC70547602	5HCL-65E
80E	1	63	3.00 (76.2)	Clip-lock	9 (4.09)	Non-disconnect	HCL-NL-1	TC70545803	TC70545903	TC70547602	5HCL-80E
100E	1	63	3.00 (76.2)	Clip-lock	9 (4.09)	Non-disconnect	HCL-NL-1	TC70545803	TC70545903	TC70547602	5HCL-100E
125E	1	63	3.00 (76.2)	Clip-lock	9 (4.09)	Non-disconnect	HCL-NL-1	TC70545803	TC70545903	TC70547602	5HCL-125E
150E	1	63	3.00 (76.2)	Clip-lock	9 (4.09)	Non-disconnect	HCL-NL-1	TC70545803	TC70545903	TC70547602	5HCL-150E
200E	1	63	3.00 (76.2)	Clip-lock	10 (4.54)	Non-disconnect	HCL-NL-1	TC70545803	TC70545903	TC70547602	5HCL-200E
250E	1	63	3.00 (76.2)	Clip-lock	10 (4.54)	Non-disconnect	HCL-NL-1	TC70545803	TC70545903	TC70547602	5HCL-250E
300E	2	63	3.00 (76.2)	Clip-lock	20 (9.08)	Non-disconnect	HCL-NL-1	TC70546003	TC70516103	TC70547602	5HCL-300E
400E	2	63	3.00 (76.2)	Clip-lock	20 (9.08)	Non-disconnect	HCL-NL-1	TC70546003	TC70516103	TC70547602	5HCL-400E
450E	2	63	3.00 (76.2)	Clip-lock	20 (9.08)	Non-disconnect	HCL-NL-1	TC70546003	TC70516103	TC70547602	5HCL-450E
500E	2	63	3.00 (76.2)	Clip-lock	20 (9.08)	Non-disconnect	HCL-NL-1	TC66703401	TC66703501	TC66703701	5HCL-500E
600E	2	63	3.00 (76.2)	Clip-lock	20 (9.08)	Non-disconnect	HCL-NL-1	TC66703401	TC66703501	TC66703701	5HCL-600E
750E	3	63	3.00 (76.2)	Bolt-in	30 (13.62)	—	—	TC66703401	TC66703501	TC66703701	5HCL-750E
	3	63	3.00 (76.2)	Bolt-in	30 (13.62)	—	—	TC66703401	TC66703501	TC66703701	5BHCL-750E
900E	3	63	3.00 (76.2)	Bolt-in	30 (13.62)	—	—	TC66703401	TC66703501	TC66703701	5HCL-900E
	3	63	3.00 (76.2)	Bolt-in	30 (13.62)	—	—	TC66703401	TC66703501	TC66703701	5BHCL-900E

HCL Type Current Limiting Fuses (15.5 kV Maximum, 14.4 kV Nominal), Indoor

Current Rating (Amperes)	Barrel Number	Interrupting Rating rms (kA Sym.)	Approximate Diameter in Inches (mm)	Clip Center	Approximate Shipping Weight Lbs (kg)	Mounting Type	Live Parts (Includes End Fittings) Catalog Number	Performance Curves			Catalog Number
								Minimum Melting Time	Total Clearing Time	Peak Let-Through Current	
10E	1	63	3.00 (76.2)	Clip-lock	10 (4.54)	Non-disconnect	HCL-NL-1	TC70548503	TC70548603	TC70548803	15HCL-10E
15E	1	63	3.00 (76.2)	Clip-lock	10 (4.54)	Non-disconnect	HCL-NL-1	TC70548503	TC70548603	TC70548803	15HCL-15E
20E	1	63	3.00 (76.2)	Clip-lock	10 (4.54)	Non-disconnect	HCL-NL-1	TC70548503	TC70548603	TC70548803	15HCL-20E
25E	1	63	3.00 (76.2)	Clip-lock	10 (4.54)	Non-disconnect	HCL-NL-1	TC70548503	TC70548603	TC70548803	15HCL-25E
30E	1	63	3.00 (76.2)	Clip-lock	10 (4.54)	Non-disconnect	HCL-NL-1	TC70548503	TC70548603	TC70548803	15HCL-30E
40E	1	63	3.00 (76.2)	Clip-lock	10 (4.54)	Non-disconnect	HCL-NL-1	TC66703201	TC66703301	TC70547402	15HCL-40E
50E	1	63	3.00 (76.2)	Clip-lock	10 (4.54)	Non-disconnect	HCL-NL-1	TC66703201	TC66703301	TC70547402	15HCL-50E
65E	1	50	3.00 (76.2)	Clip-lock	12 (5.45)	Non-disconnect	HCL-NL-1	TC66703201	TC66703301	TC70547402	15HCL-65E
80E	1	50	3.00 (76.2)	Clip-lock	12 (5.45)	Non-disconnect	HCL-NL-1	TC66703201	TC66703301	TC70547402	15HCL-80E
100E	1	50	3.00 (76.2)	Clip-lock	12 (5.45)	Non-disconnect	HCL-NL-1	TC66703201	TC66703301	TC70547402	15HCL-100E
125E	1	50	3.00 (76.2)	Clip-lock	12 (5.45)	Non-disconnect	HCL-NL-1	TC66703201	TC66703301	TC70547402	15HCL-125E
150E	2	50	3.00 (76.2)	Clip-lock	24 (10.90)	Non-disconnect	HCL-NL-1	TC66703201	TC66703301	TC70547402	15HCL-150E
200E	2	50	3.00 (76.2)	Clip-lock	24 (10.90)	Non-disconnect	HCL-NL-1	TC66703201	TC66703301	TC70547402	15HCL-200E
250E	2	50	3.00 (76.2)	Clip-lock	24 (10.90)	Non-disconnect	HCL-NL-1	TC66703201	TC66703301	TC70547402	15HCL-250E
300E	2	50	3.00 (76.2)	Clip-lock	24 (10.90)	Non-disconnect	HCL-NL-1	TC66703201	TC66703301	TC70547402	15HCL-300E

Fuse Dimensional Details

Approximate Dimensions in Inches (mm)

5.5 and 15.5 kV Clip Lock Mounted

Ampere Rating	Number of Barrels	Figure Number	A	B	C	Interrupting Rating rms (kA Sym.)
5.5 kV Maximum—Clip Lock Style—15.25-Inch (387.4 mm) Clip Centers—3.00-Inch (76.2 mm) Barrel Diameter						
10E–150E	1	A	16.81 (427.0)	16.12 (409.4)	Ⓢ	63
5.5 kV Maximum—Clip Lock Style—21.25-Inch (539.8 mm) Clip Centers—3.00-Inch (76.2 mm) Barrel Diameter						
200E–600E	1	A	22.81 (579.4)	22.12 (561.8)	Ⓢ	63

15.5 kV Clip Lock Mounted

Ampere Rating	Number of Barrels	Figure Number	A	B	C	Interrupting Rating rms (kA Sym.)
15.5 kV Maximum—Clip Lock Style—21.25-Inch (539.8 mm) Clip Centers—3.00-Inch (76.2 mm) Barrel Diameter						
65E–125E	1	A	22.81 (579.4)	22.12 (561.8)	Ⓢ	63
150E–300E	2	B	22.81 (579.4)	22.12 (561.8)	Ⓢ	50
15.5 kV Maximum—Clip Lock Style—18.25-Inch (463.6 mm) Clip Centers—3.00-Inch (76.2 mm) Barrel Diameter						
10E–50E	1	A	19.81 (503.2)	19.12 (485.6)	Ⓢ	63

Bolt-In Series—5.5 kV

Ampere Rating	Number of Barrels	Figure Number	A	B	C	D	Interrupting Rating rms (kA Sym.)
5.5 kV Maximum—Bolt-in Style—23.73-Inch (602.7 mm) Hole Centers—3.00-Inch (76.2 mm) Barrel Diameter							
750E, 900E	3	C	25.11 (637.8)	22.37 (568.2)	23.73 (602.7)	Ⓢ	63

HCL-14 Type Fuse

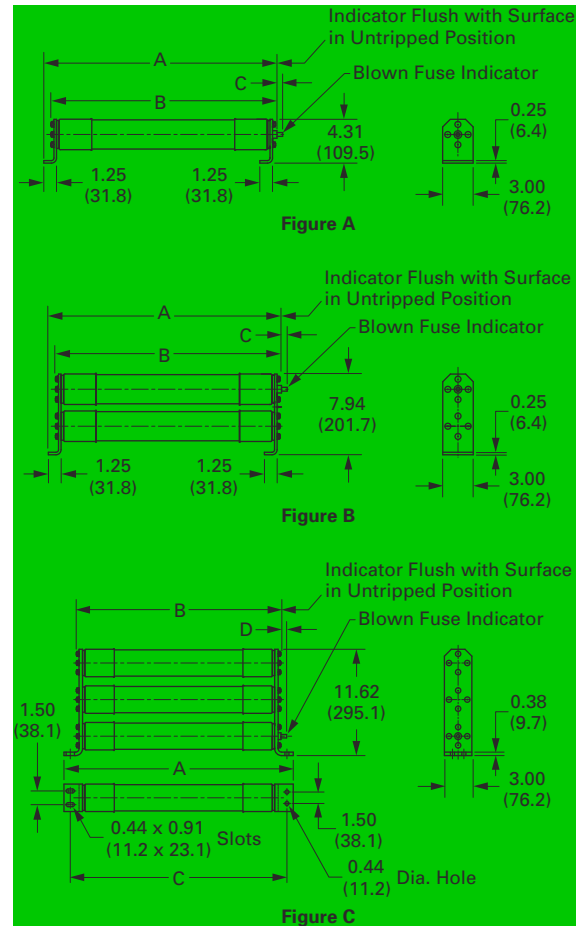

HCL Type Fuse

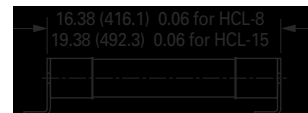

Note

Ⓢ 0.5 (12.7) tripped force 2 lb (0.9 kg).

3.4

Current Limiting Fuses

CLE, HLE, LHLE, AHLE, BHLE, HCL and BHCL Type Fuses

Mounting Details

Approximate Dimensions in Inches (mm)

3

CLE and HLE Type Disconnect Type Mountings

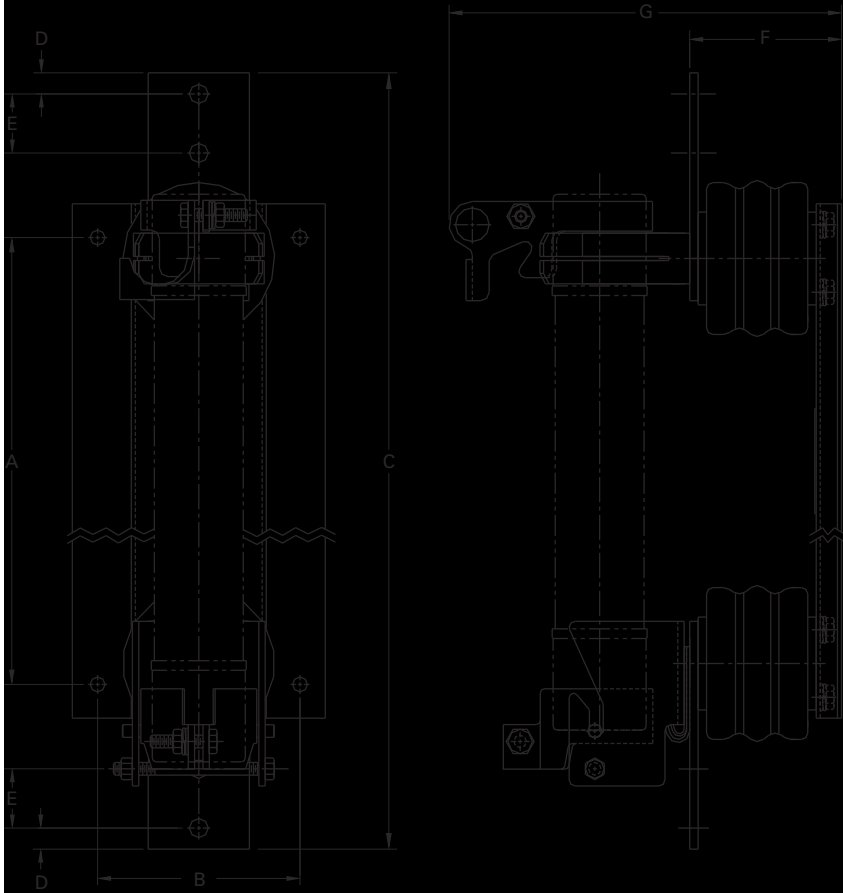

CLE, HLE, LHLE, AHLE, BHLE, HCL and BHCL Type Fuses

Approximate Dimensions in Inches (mm)

CLE and HLE Type Disconnect Mounting—Single

Catalog Number	Hole Centers A	Hole Centers B	Overall Length C	Hole Inset D	Hole Centers E	Contact Height F	Overall Height G	BIL Rating
2CLE-GDM-C	9.37 (238.0)	6.00 (152.4)	22.13 (562.1)	0.75 (19.0)	1.75 (44.4)	4.50 (114.3)	9.75 (247.6)	60
2CLE-GDM-D	8.24 (209.3)	6.00 (152.4)	18.00 (457.2)	0.62 (15.7)	1.75 (44.4)	4.50 (114.3)	11.72 (297.7)	60
2CLE-PDM-C	9.37 (238.0)	6.00 (152.4)	22.13 (562.1)	0.75 (19.0)	1.75 (44.4)	4.50 (114.3)	9.75 (247.6)	60
2CLE-PDM-D	8.24 (209.3)	6.00 (152.4)	18.00 (457.2)	0.62 (15.7)	1.75 (44.4)	4.50 (114.3)	11.72 (297.7)	60
5CLE-GDM-C	12.74 (323.6)	6.00 (152.4)	25.50 (647.7)	0.75 (19.0)	1.75 (44.4)	4.50 (114.3)	9.75 (247.6)	60
5CLE-PDM-C	12.74 (323.6)	6.00 (152.4)	25.50 (647.7)	0.75 (19.0)	1.75 (44.4)	4.50 (114.3)	9.75 (247.6)	60
5CLE-GDM-D	15.24 (387.1)	6.00 (152.4)	25.00 (647.7)	0.62 (15.7)	1.75 (44.4)	4.50 (114.3)	11.72 (297.7)	60
5CLE-PDM-D	15.24 (387.1)	6.00 (152.4)	25.00 (647.7)	0.62 (15.7)	1.75 (44.4)	4.50 (114.3)	11.72 (297.7)	60
5HLE-GDM-D	16.25 (412.8)	6.00 (152.4)	23.00 (584.2)	0.62 (15.7)	1.75 (44.4)	4.50 (114.3)	11.72 (297.7)	60
5HLE-PDM-D	16.25 (412.8)	6.00 (152.4)	23.00 (584.2)	0.62 (15.7)	1.75 (44.4)	4.50 (114.3)	11.72 (297.7)	60
8CLE-GDM-C	15.24 (387.1)	6.00 (152.4)	28.00 (711.2)	0.75 (19.0)	1.75 (44.4)	7.00 (177.8)	12.37 (314.2)	75
8CLE-GDM-D	15.24 (387.1)	6.00 (152.4)	25.00 (647.7)	0.62 (15.7)	1.75 (44.4)	7.00 (177.8)	14.22 (361.2)	75
8CLE-PDM-C	15.24 (387.1)	6.00 (152.4)	28.00 (711.2)	0.75 (19.0)	1.75 (44.4)	7.00 (177.8)	12.37 (314.2)	75
8CLE-PDM-D	15.24 (387.1)	6.00 (152.4)	25.00 (647.7)	0.62 (15.7)	1.75 (44.4)	7.00 (177.8)	14.22 (361.2)	75
8HLE-GDM-D	16.25 (412.8)	6.00 (152.4)	23.00 (584.2)	0.62 (15.7)	1.75 (44.4)	7.00 (177.8)	11.72 (297.7)	75
8HLE-PDM-D	16.25 (412.8)	6.00 (152.4)	23.00 (584.2)	0.62 (15.7)	1.75 (44.4)	7.00 (177.8)	11.72 (297.7)	75
15CLE-GDM-C	21.24 (539.5)	6.00 (152.4)	34.00 (863.6)	0.75 (19.0)	1.75 (44.4)	7.00 (177.8)	12.37 (314.2)	95
15CLE-GDM-D	21.15 (537.2)	6.00 (152.4)	31.00 (787.4)	0.62 (15.7)	1.75 (44.4)	7.00 (177.8)	14.22 (361.2)	95
15CLE-PDM-C	21.24 (539.5)	6.00 (152.4)	34.00 (863.6)	0.75 (19.0)	1.75 (44.4)	7.00 (177.8)	12.37 (314.2)	95
15CLE-PDM-D	21.15 (537.2)	6.00 (152.4)	31.00 (787.4)	0.62 (15.7)	1.75 (44.4)	7.00 (177.8)	14.22 (361.2)	95
15CLE-HPDM-C	21.24 (539.5)	6.00 (152.4)	34.00 (863.6)	0.75 (19.0)	1.75 (44.4)	8.50 (215.9)	13.87 (352.3)	110
15CLE-HPDM-D	21.15 (537.2)	6.00 (152.4)	31.00 (787.4)	0.62 (15.7)	1.75 (44.4)	8.50 (215.9)	13.87 (352.3)	110
15HLE-GDM-D	16.25 (412.8)	6.00 (152.4)	25.00 (647.7)	0.62 (15.7)	1.75 (44.4)	7.00 (177.8)	14.22 (361.2)	95
15HLE-PDM-D	16.25 (412.8)	6.00 (152.4)	25.00 (647.7)	0.62 (15.7)	1.75 (44.4)	7.00 (177.8)	14.22 (361.2)	95

CLE and HLE Type Non-Disconnect Mounting—Double

Catalog Number	Hole Centers A	Hole Centers B	Overall Length C	Hole Inset D	Hole Centers E	Contact Height F	Overall Height G	BIL Rating
2CLE-GDM-E	8.24 (209.3)	6.00 (152.4)	18.00 (457.2)	0.62 (15.7)	1.75 (44.4)	4.50 (114.3)	15.28 (388.1)	60
2CLE-PDM-E	8.24 (209.3)	6.00 (152.4)	18.00 (457.2)	0.62 (15.7)	1.75 (44.4)	4.50 (114.3)	15.28 (388.1)	60
5CLE-GDM-E	15.24 (387.1)	6.00 (152.4)	25.00 (647.7)	0.62 (15.7)	1.75 (44.4)	4.50 (114.3)	15.28 (388.1)	60
5CLS-PDM-E	15.24 (387.1)	6.00 (152.4)	25.00 (647.7)	0.62 (15.7)	1.75 (44.4)	4.50 (114.3)	15.28 (388.1)	60
5HLE-GDM-E	16.25 (412.8)	6.00 (152.4)	23.00 (584.2)	0.62 (15.7)	1.75 (44.4)	4.50 (114.3)	15.28 (388.1)	60
5HLE-PDM-E	16.25 (412.8)	6.00 (152.4)	23.00 (584.2)	0.62 (15.7)	1.75 (44.4)	4.50 (114.3)	15.28 (388.1)	60
8CLE-GDM-E	15.24 (387.1)	6.00 (152.4)	25.00 (647.7)	0.62 (15.7)	1.75 (44.4)	7.00 (177.8)	17.78 (451.6)	75
8CLE-PDM-E	15.24 (387.1)	6.00 (152.4)	25.00 (647.7)	0.62 (15.7)	1.75 (44.4)	7.00 (177.8)	17.78 (451.6)	75
8HLE-GDM-E	16.25 (412.8)	6.00 (152.4)	23.00 (584.2)	0.62 (15.7)	1.75 (44.4)	7.00 (177.8)	17.78 (451.6)	75
8HLE-PDM-E	16.25 (412.8)	6.00 (152.4)	23.00 (584.2)	0.62 (15.7)	1.75 (44.4)	7.00 (177.8)	17.78 (451.6)	75
15CLE-PDM-E	21.15 (537.2)	6.00 (152.4)	31.00 (787.4)	0.62 (15.7)	1.75 (44.4)	8.50 (215.9)	19.28 (489.7)	95
15HLE-GDM-E	16.25 (412.8)	6.00 (152.4)	26.00 (660.4)	0.62 (15.7)	1.75 (44.4)	7.00 (177.8)	17.78 (451.6)	95
15HLE-PDM-E	16.25 (412.8)	6.00 (152.4)	26.00 (660.4)	0.62 (15.7)	1.75 (44.4)	7.00 (177.8)	17.78 (451.6)	95

3.4

Current Limiting Fuses

CLE, HLE, LHLE, AHLE, BHLE, HCL and BHCL Type Fuses

Approximate Dimensions in Inches (mm)

CLE and HLE Type Non-Disconnect Mountings

3

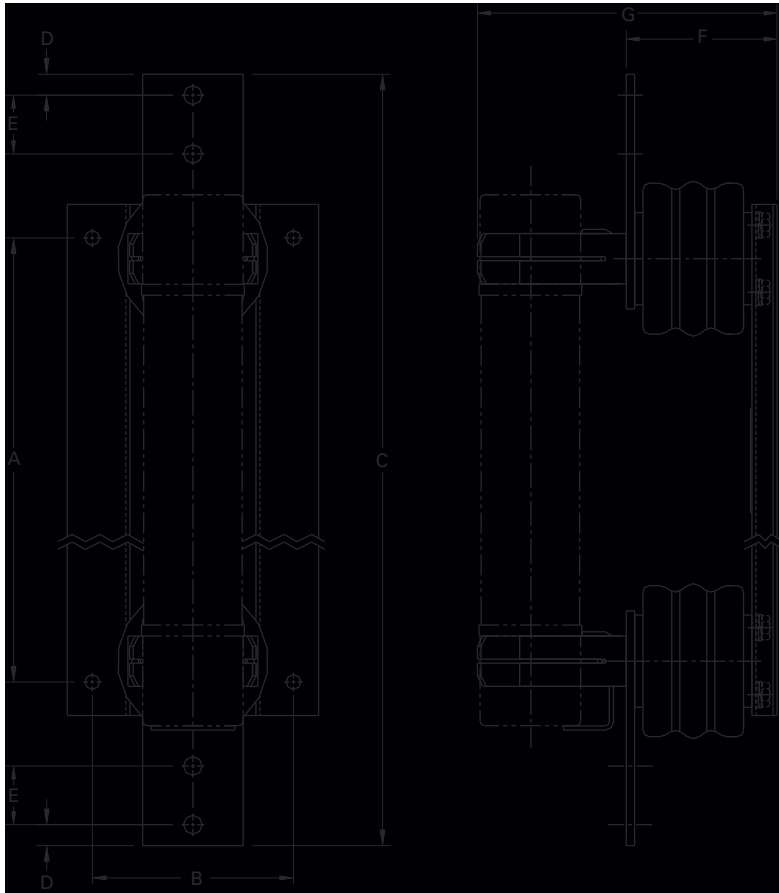

CLE, HLE, LHLE, AHLE, BHLE, HCL and BHCL Type Fuses

Approximate Dimensions in Inches (mm)

CLE and HLE Type Non-Disconnect Mounting—Single

Catalog Number	Hole Centers A	Hole Centers B	Overall Length C	Hole Inset D	Hole Centers E	Contact Height F	Overall Height G	BIL Rating
2CLE-GNM-C	9.37 (238.0)	6.00 (152.4)	18.63 (473.2)	0.75 (19.0)	1.75 (44.4)	4.50 (114.3)	7.25 (184.1)	60
2CLE-PNM-C	9.37 (238.0)	6.00 (152.4)	18.63 (473.2)	0.75 (19.0)	1.75 (44.4)	4.50 (114.3)	7.25 (184.1)	60
2CLE-GNM-D	8.24 (209.3)	6.00 (152.4)	18.00 (457.2)	0.62 (15.7)	1.75 (44.4)	4.50 (114.3)	8.79 (223.3)	60
2CLE-PNM-D	8.24 (209.3)	6.00 (152.4)	18.00 (457.2)	0.62 (15.7)	1.75 (44.4)	4.50 (114.3)	8.79 (223.3)	60
5CLE-GNM-C	12.75 (323.8)	6.00 (152.4)	22.00 (558.8)	0.75 (19.0)	1.75 (44.4)	4.50 (114.3)	7.25 (184.1)	60
5CLE-PNM-C	12.75 (323.8)	6.00 (152.4)	22.00 (558.8)	0.75 (19.0)	1.75 (44.4)	4.50 (114.3)	7.25 (184.1)	60
5CLE-GNM-D	15.24 (387.1)	6.00 (152.4)	25.00 (635.0)	0.62 (15.7)	1.75 (44.4)	4.50 (114.3)	8.79 (223.3)	60
5CLE-PNM-D	15.24 (387.1)	6.00 (152.4)	25.00 (635.0)	0.62 (15.7)	1.75 (44.4)	4.50 (114.3)	8.79 (223.3)	60
5HLE-GNM-D	16.25 (412.7)	6.00 (152.4)	23.00 (584.2)	0.62 (15.7)	1.75 (44.4)	4.50 (114.3)	8.79 (223.3)	60
15HLE-PNM-D	16.25 (412.7)	6.00 (152.4)	23.00 (584.2)	0.62 (15.7)	1.75 (44.4)	4.50 (114.3)	8.79 (223.3)	60
8CLE-GNM-C	15.25 (387.3)	6.00 (152.4)	24.50 (622.3)	0.75 (19.0)	1.75 (44.4)	7.00 (177.8)	9.75 (247.6)	75
8CLE-PNM-C	15.25 (387.3)	6.00 (152.4)	24.50 (622.3)	0.75 (19.0)	1.75 (44.4)	7.00 (177.8)	9.75 (247.6)	75
8CLE-PNM-D	15.25 (387.3)	6.00 (152.4)	25.00 (635.0)	0.62 (15.7)	1.75 (44.4)	7.00 (177.8)	11.29 (286.7)	75
8CLE-PNM-D	15.25 (387.3)	6.00 (152.4)	25.00 (635.0)	0.62 (15.7)	1.75 (44.4)	7.00 (177.8)	11.29 (286.7)	75
8HLE-GNM-D	16.25 (412.7)	6.00 (152.4)	23.00 (584.2)	0.62 (15.7)	1.75 (44.4)	7.00 (177.8)	11.29 (286.7)	75
8HLE-PNM-D	16.25 (412.7)	6.00 (152.4)	23.00 (584.2)	0.62 (15.7)	1.75 (44.4)	7.00 (177.8)	11.29 (286.7)	75
15CLE-GNM-C	21.25 (539.7)	6.00 (152.4)	30.50 (774.7)	0.75 (19.0)	1.75 (44.4)	7.00 (177.8)	9.75 (247.6)	95
15CLE-PNM-C	21.25 (539.7)	6.00 (152.4)	30.50 (774.7)	0.75 (19.0)	1.75 (44.4)	7.00 (177.8)	9.75 (247.6)	95
15CLE-HPMN-C	21.25 (539.7)	6.00 (152.4)	30.50 (774.7)	0.75 (19.0)	1.75 (44.4)	8.50 (215.9)	11.25 (285.7)	110
15CLE-GNM-D	21.15 (539.7)	6.00 (152.4)	31.00 (787.4)	0.62 (15.7)	1.75 (44.4)	7.00 (177.8)	11.29 (286.7)	95
15CLE-PNM-D	21.15 (539.7)	6.00 (152.4)	31.00 (787.4)	0.62 (15.7)	1.75 (44.4)	7.00 (177.8)	11.29 (286.7)	95
15CLE-HPNM-D	21.15 (539.7)	6.00 (152.4)	31.00 (787.4)	0.62 (15.7)	1.75 (44.4)	8.50 (215.9)	12.79 (286.7)	110
15HLE-GNM-D	16.25 (412.7)	6.00 (152.4)	26.00 (660.4)	0.62 (15.7)	1.75 (44.4)	7.00 (177.8)	11.29 (286.7)	95
15HLE-PNM-D	16.25 (412.7)	6.00 (152.4)	26.00 (660.4)	0.62 (15.7)	1.75 (44.4)	7.00 (177.8)	11.29 (286.7)	95

CLE and HLE Type Non-Disconnect Mounting—Double

Catalog Number	Hole Centers A	Hole Centers B	Overall Length C	Hole Inset D	Hole Centers E	Contact Height F	Overall Height G	BIL Rating
2CLE-GNM-E	8.24 (209.3)	6.00 (152.4)	18.00 (457.2)	0.62 (15.7)	1.75 (44.4)	4.50 (114.3)	12.48 (317.0)	60
2CLE-PNM-E	8.24 (209.3)	6.00 (152.4)	18.00 (457.2)	0.62 (15.7)	1.75 (44.4)	4.50 (114.3)	12.48 (317.0)	60
5CLE-GNM-E	15.24 (387.1)	6.00 (152.4)	25.00 (635.0)	0.62 (15.7)	1.75 (44.4)	4.50 (114.3)	12.48 (317.0)	60
5HLE-PNM-E	15.24 (387.1)	6.00 (152.4)	25.00 (635.0)	0.62 (15.7)	1.75 (44.4)	4.50 (114.3)	12.48 (317.0)	60
5HLE-GNM-E	16.25 (412.7)	6.00 (152.4)	23.00 (584.2)	0.62 (15.7)	1.75 (44.4)	4.50 (114.3)	12.48 (317.0)	60
5HLE-PNM-E	16.25 (412.7)	6.00 (152.4)	23.00 (584.2)	0.62 (15.7)	1.75 (44.4)	4.50 (114.3)	12.48 (317.0)	60
8CLE-GNM-E	15.24 (387.1)	6.00 (152.4)	25.00 (635.0)	0.62 (15.7)	1.75 (44.4)	7.00 (177.8)	14.98 (380.5)	75
8CLE-PNM-E	15.24 (387.1)	6.00 (152.4)	25.00 (635.0)	0.62 (15.7)	1.75 (44.4)	7.00 (177.8)	14.98 (380.5)	75
8HLE-GNM-E	16.25 (412.7)	6.00 (152.4)	23.00 (584.2)	0.62 (15.7)	1.75 (44.4)	7.00 (177.8)	14.98 (380.5)	75
8HLE-PNM-E	16.25 (412.7)	6.00 (152.4)	23.00 (584.2)	0.62 (15.7)	1.75 (44.4)	7.00 (177.8)	14.98 (380.5)	75
15CLE-PNM-E	21.15 (539.7)	6.00 (152.4)	31.00 (787.4)	0.62 (15.7)	1.75 (44.4)	8.50 (215.9)	16.48 (418.5)	95
15HLE-GNM-E	16.25 (412.7)	6.00 (152.4)	26.00 (660.4)	0.62 (15.7)	1.75 (44.4)	7.00 (177.8)	14.98 (380.5)	95
15HLE-PNM-E	16.25 (412.7)	6.00 (152.4)	26.00 (660.4)	0.62 (15.7)	1.75 (44.4)	7.00 (177.8)	14.98 (380.5)	95

(N)CLPT Fuses



CLPT and NCLPT Type Fuses

Product Description

Eaton CLPT (indicating) and NCLPT (non-indicating) fuses are applied wherever it is necessary to limit the short-circuit currents on control transformer and potential transformer circuits in high capacity systems in industrial installations and commercial buildings.

Current ratings from 1/2E to 10E are available at 2.4 kV to 34.5 kV.

Features

CLPT and NCLPT type current limiting fuses offer a number of desirable advantages. Consider the following during the selection process:

- **Quiet Safe Operation:** These fuses are designed for silent operation and elimination of flame discharges when the fuse operates
- **Identification of Blown Fuse:** These fuses are available in indicating and non-indicating versions. Indicators protrude from indicating type fuses providing a visual indication of a blown fuse

- **Space Economy:** Because the fuse is designed to eliminate flame and gas discharges, no exhaust control devices, flame boxes, vents or reinforcing are required
- **Complete Protection Provided:** Current limiting fuses provide positive interruption even on low fault currents. The fuse limits the magnitude of electromechanical stresses in the apparatus to be protected
- **Mountings:** Disconnect and non-disconnect mountings are available for most types of fuses from 5 kV through 15 kV. Live parts are available for 23 kV and 34.5 kV fuses
- **Dimensions:** Various fuse sizes are available for a wide range of applications

Construction

CLPT type current limiting fuses are basically constructed in a similar fashion to other Eaton current limiting fuses.

Contents

Description

CLPT and NCLPT Type Fuses

	<i>Page</i>
Catalog Number Selection	V14-T3-43
Product Selection	V14-T3-43
Mounting Details	V14-T3-48

Ratings and Selection

When a decision has been made to use current limiting fuses, the minimum amount of information required to make the proper selection is:

- Voltage rating
- Current rating
- Interrupting rating
- Mounting method
 - Non-disconnect mounting
 - Disconnect mounting
 - Live parts only
 - No required mounting

Refer to tables on **Pages V14-T3-43 to V14-T3-49** for assistance in selecting the correct fuse catalog number.

These types of fuses are used in conjunction with potential and control power transformers. There are specific rules governing the selection of the required fuse continuous rating. The current limiting fuse application notes earlier in this publication offer additional information about this type of application.

When selecting the appropriate fuse for a new installation, keep in mind that one fuse unit and one compatible mounting may be required for each phase.

Catalog Number Selection

CLPT Fuse Units

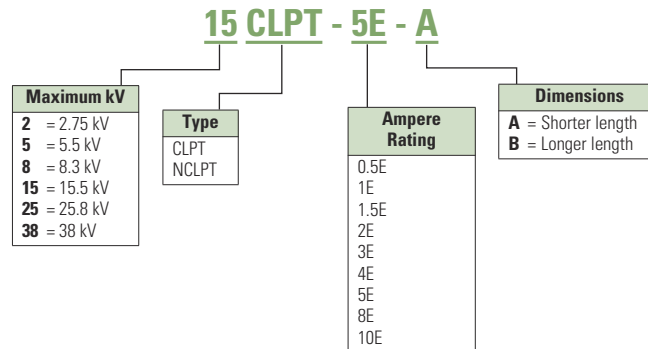

CLPT Mounting

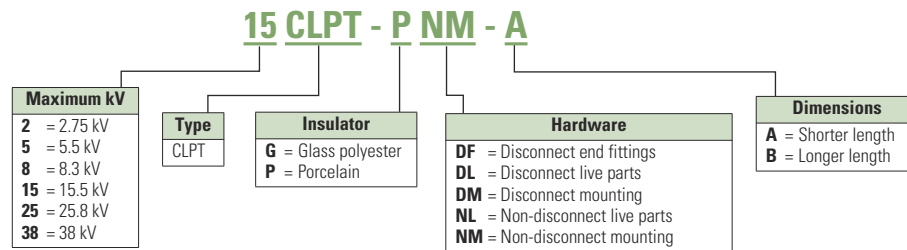

Product Selection

CLPT Type

Indicating



CLPT Type Current Limiting Fuses 2.475 kV Maximum (2.4 kV Nominal)

Current Rating (Amperes)	Interrupting Rating rms (kA Sym.)	Diameter	Clip Center	Length	Approximate Shipping Weight Lbs (kg)	Performance Curves			Catalog Number
						Minimum Melting Time	Total Clearing Time	Peak Let-Through Current	
0.25E	63	0.81 (20.6)	—	4.50 (114.3)	0.25 (0.11)	TC56357202	TC59883702	TC63933702	2NCLPT-.25E
0.5E	63	0.81 (20.6)	—	4.50 (114.3)	0.25 (0.11)	TC56357202	TC59883702	TC63933702	2NCLPT-.5E
1E	40	0.81 (20.6)	—	4.50 (114.3)	0.25 (0.11)	TC56357202	TC59883702	TC63933702	2NCLPT-1E
2E	40	0.81 (20.6)	—	4.50 (114.3)	0.25 (0.11)	TC56357202	TC59883702	TC63933702	2NCLPT-2E
5E	25	0.81 (20.6)	—	4.50 (114.3)	0.25 (0.11)	TC56357202	TC59883702	TC63933702	2NCLPT-5E

CLPT Type Current Limiting Fuses 5.5 kV Maximum (4.8 kV Nominal)

3

Non-Indicating



Current Rating (Amperes)	Interrupting Rating rms (kA Sym.)	Diameter	Clip Center	Length	Approximate Shipping Weight Lbs (kg)	Performance Curves		Peak Let-Through Current	Catalog Number
						Minimum Melting Time	Total Clearing Time		
Approximate Dimensions in Inches (mm)									
Non-Indicating									
0.5E	63	0.81 (20.6)	—	5.63 (143.0)	0.25 (0.11)	TC66702402	TC66702502	TC66704101	5NCLPT-.5E
1E	63	0.81 (20.6)	—	5.63 (143.0)	0.25 (0.11)	TC66702402	TC66702502	TC66704101	5NCLPT-1E
2E	63	0.81 (20.6)	—	5.63 (143.0)	0.25 (0.11)	TC66702402	TC66702502	TC66704101	5NCLPT-2E
3E	63	0.81 (20.6)	—	5.63 (143.0)	0.25 (0.11)	TC66702402	TC66702502	TC66704101	5NCLPT-3E
4E	63	0.81 (20.6)	—	5.63 (143.0)	0.25 (0.11)	TC66702402	TC66702502	TC66704101	5NCLPT-4E
5E	63	0.81 (20.6)	—	5.63 (143.0)	0.25 (0.11)	TC66702402	TC66702502	TC66704101	5NCLPT-5E
0.5E	50	1.00 (25.4)	—	5.63 (143.0)	0.25 (0.11)	TC66702402	TC66702502	TC66704101	317B487H02
1E	50	1.00 (25.4)	—	5.63 (143.0)	0.25 (0.11)	TC66702402	TC66702502	TC66704101	317B487H06
2E	50	1.00 (25.4)	—	5.63 (143.0)	0.25 (0.11)	TC66702402	TC66702502	TC66704101	317B487H03
3E	50	1.00 (25.4)	—	5.63 (143.0)	0.25 (0.11)	TC66702402	TC66702502	TC66704101	317B487H04
5E	50	1.00 (25.4)	—	5.63 (143.0)	0.25 (0.11)	TC66702402	TC66702502	TC66704101	317B487H05
0.5E	63	1.60 (40.6)	8.10 (205.7)	9.50 (241.3)	1.2 (0.54)	TC70548302	TC70548402	TC63934002	5NCLPT-.5E-A
1E	63	1.60 (40.6)	8.10 (205.7)	9.50 (241.3)	1.2 (0.54)	TC70548302	TC70548402	TC63934002	5NCLPT-1E-A
2E	63	1.60 (40.6)	8.10 (205.7)	9.50 (241.3)	1.2 (0.54)	TC70548302	TC70548402	TC63934002	5NCLPT-2E-A
3E	63	1.60 (40.6)	8.10 (205.7)	9.50 (241.3)	1.2 (0.54)	TC70548302	TC70548402	TC63934002	5NCLPT-3E-A
5E	63	1.60 (40.6)	8.10 (205.7)	9.50 (241.3)	1.2 (0.54)	TC70548302	TC70548402	TC63934002	5NCLPT-5E-A
10E	63	1.60 (40.6)	8.10 (205.7)	9.50 (241.3)	1.2 (0.54)	TC70548302	TC70548402	TC63934002	5NCLPT-10E-A

Indicating



Indicating									
0.5E	80	1.60 (40.6)	8.10 (205.7)	9.50 (241.3)	1.2 (0.54)	TC56353206	TC56353306	TC63934001	5CLPT-.5E
1E	80	1.60 (40.6)	8.10 (205.7)	9.50 (241.3)	1.2 (0.54)	TC56353206	TC56353306	TC63934001	5CLPT-1E
1.5E	80	1.60 (40.6)	8.10 (205.7)	9.50 (241.3)	1.2 (0.54)	TC56353206	TC56353306	TC63934001	5CLPT-1.5E
3E	80	1.60 (40.6)	8.10 (205.7)	9.50 (241.3)	1.2 (0.54)	TC56353206	TC56353306	TC63934001	5CLPT-3E
5E	80	1.60 (40.6)	8.10 (205.7)	9.50 (241.3)	1.2 (0.54)	TC56353206	TC56353306	TC63934001	5CLPT-5E
10E	80	1.60 (40.6)	8.10 (205.7)	9.50 (241.3)	1.2 (0.54)	TC56353206	TC56353306	TC63934001	5CLPT-10E

CLPT Type Mountings and Hardware 5.5 kV Maximum (4.8 kV Nominal) ①

Ampere Rating	Fuse Mounting Type ②	Voltage BIL (kV)	Mounting (Including Live Parts, End Fittings) ③		Live Parts (Including End Fittings) ③	End Fittings (Disconnect Only)
			Porcelain Insulator Catalog Number	Glass-Polyester Insulator Catalog Number		
0.5–2	Non-disconnect	60	5CLPT-PNM-A	5CLPT-GNM-A	CLPT-NL	—
	Disconnect	60	5CLPT-PDM-A	5CLPT-GDM-A	CLPT-DL	CLPT-DF
3–10	Non-disconnect	60	5CLPT-PNM-B	5CLPT-GNM-B	CLPT-NL	—
	Disconnect	60	5CLPT-PDM-B	5CLPT-GDM-B	CLPT-DL	CLPT-DF

Notes

- ① Refers only to 5CLPT and 5NCLPT-A fuses only.
- ② See Page V14-T3-38 for diagram of typical mounting.
- ③ End fittings supplied only when required.

CLPT Type Current Limiting Fuses 8.3 kV Maximum (7.2 kV Nominal)

3

Non-Indicating



Current Rating (Amperes)	Interrupting Rating rms (kA Sym.)	Diameter	Clip Center	Length	Approximate Shipping Weight Lbs (kg)	Performance Curves		Peak Let-Through Current	Catalog Number
						Minimum Melting Time	Total Clearing Time		
Approximate Dimensions in Inches (mm)									
Non-Indicating									
2E	25	0.81 (20.6)	—	8.00 (203.2)	0.25 (0.11)	TC56357206	TC59883706	TC63933704	8NCLPT-2E
4E	25	0.81 (20.6)	—	8.00 (203.2)	0.25 (0.11)	TC56357206	TC59883706	TC63933704	8NCLPT-4E
10E	50	1.10 (27.9)	—	5.00 (127.0)	0.5 (0.23)	TC56357206	TC59883706	TC63933704	8NCLPT-0E
1E	50	1.10 (27.9)	—	5.00 (127.0)	0.5 (0.23)	TC56357206	TC59883706	TC63933704	8NCLPT-1E
5E	50	1.10 (27.9)	—	5.00 (127.0)	0.5 (0.23)	TC56357206	TC59883706	TC63933704	8NCLPT-5E
0.5E	50	1.60 (40.6)	8.10 (205.7)	9.50 (241.3)	1.5 (0.70)	TC70548303	TC70548403	TC63934002	8NCLPT-.5E-A
1E	50	1.60 (40.6)	8.10 (205.7)	9.50 (241.3)	1.5 (0.70)	TC70548303	TC70548403	TC63934002	8NCLPT-1E-A
2E	50	1.60 (40.6)	8.10 (205.7)	9.50 (241.3)	1.5 (0.70)	TC70548303	TC70548403	TC63934002	8NCLPT-2E-A
3E	50	1.60 (40.6)	8.10 (205.7)	9.50 (241.3)	1.5 (0.70)	TC70548303	TC70548403	TC63934002	8NCLPT-3E-B
5E	50	1.60 (40.6)	11.50 (292.1)	12.90 (327.7)	1.6 (0.73)	TC70548303	TC70548403	TC63934002	8NCLPT-5E-B
10E	50	1.60 (40.6)	11.50 (292.1)	12.90 (327.7)	1.6 (0.73)	TC70548303	TC70548403	TC63934002	8NCLPT-10E-B
Indicating									
.5E	80	1.60 (40.6)	8.10 (205.7)	9.50 (241.3)	1.5 (0.70)	TC56353206	TC56353306	TC63934001	8CLPT-.5E
3E	80	1.60 (40.6)	8.10 (205.7)	9.50 (241.3)	1.6 (0.73)	TC56353206	TC56353306	TC63934001	8CLPT-3E
5E	50	1.60 (40.6)	8.10 (205.7)	9.50 (241.3)	1.6 (0.73)	TC56353206	TC56353306	TC63934001	8CLPT-5E
10E	50	1.60 (40.6)	8.10 (205.7)	9.50 (241.3)	1.6 (0.73)	TC56353206	TC56353306	TC63934001	8CLPT-10E

Indicating



CLPT Type Mountings and Hardware 8.3 kV Maximum (7.2 kV Nominal) ①

Ampere Rating	Fuse Mounting Type ②	Voltage BIL (kV)	Mounting (Including Live Parts, End Fittings) ③		Live Parts (Including End Fittings) ③	End Fittings (Disconnect Only)
			Porcelain Insulator Catalog Number	Glass-Polyester Insulator Catalog Number		
0.5–2	Non-disconnect	75	8CLPT-PNM-A	8CLPT-GNM-A	CLPT-NL	—
	Disconnect	75	8CLPT-PDM-A	8CLPT-GDM-A	CLPT-DL	CLPT-DF
3–10	Non-disconnect	75	8CLPT-PNM-B	8CLPT-GNM-B	CLPT-NL	—
	Disconnect	75	8CLPT-PDM-B	8CLPT-GDM-B	CLPT-DL	CLPT-DF

Notes

- ① Refers only to 8CLPT and 8NCLPT-A or -B fuses only.
- ② See **Page V14-T3-38** for diagram of typical mounting.
- ③ End fittings supplied only when required.

CLPT Type Current Limiting Fuses 15.5 kV Maximum (7.2 kV Nominal)

Current Rating (Amperes)	Interrupting Rating rms (kA Sym.)	Diameter	Clip Center	Length	Approximate Shipping Weight Lbs (kg)	Performance Curves			Catalog Number
						Minimum Melting Time	Total Clearing Time	Peak Let-Through Current	
Approximate Dimensions in Inches (mm)									
Non-Indicating									
0.5E	63	1.60 (40.6)	11.50 (292.1)	12.90 (327.7)	1.6 (0.73)	TC70548303	TC70548403	TC63934002	15NCLPT-.5E
1E	63	1.60 (40.6)	11.50 (292.1)	12.90 (327.7)	1.6 (0.73)	TC70548303	TC70548403	TC63934002	15NCLPT-1E
2E	63	1.60 (40.6)	11.50 (292.1)	12.90 (327.7)	1.6 (0.73)	TC70548303	TC70548403	TC63934002	15NCLPT-1.5E
3E	63	1.60 (40.6)	16.10 (408.9)	17.60 (447.0)	2 (0.91)	TC70548303	TC70548403	TC63934002	15NCLPT-3E
5E	63	1.60 (40.6)	16.10 (408.9)	17.60 (447.0)	2 (0.91)	TC70548303	TC70548403	TC63934002	15NCLPT-5E
10E	63	1.60 (40.6)	16.10 (408.9)	17.60 (447.0)	2 (0.91)	TC70548303	TC70548403	TC63934002	15NCLPT-10E
Indicating									
0.5E	80	1.60 (40.6)	11.50 (292.1)	12.90 (327.7)	1.6 (0.73)	TC56353206	TC56353306	TC63934001	15CLPT-.5E
1E	80	1.60 (40.6)	11.50 (292.1)	12.90 (327.7)	1.6 (0.73)	TC56353206	TC56353306	TC63934001	15CLPT-1E
2E	80	1.60 (40.6)	11.50 (292.1)	12.90 (327.7)	1.6 (0.73)	TC56353206	TC56353306	TC63934001	15CLPT-1.5E
3E	80	1.60 (40.6)	16.10 (408.9)	17.60 (447.0)	2 (0.91)	TC56353206	TC56353306	TC63934001	15CLPT-3E
5E	80	1.60 (40.6)	16.10 (408.9)	17.60 (447.0)	2 (0.91)	TC56353206	TC56353306	TC63934001	15CLPT-5E
10E	50	1.60 (40.6)	16.10 (408.9)	17.60 (447.0)	2 (0.91)	TC56353206	TC56353306	TC63934001	15CLPT-10E



CLPT Type Mountings and Hardware 15.5 kV Maximum (14.4 kV Nominal)

Ampere Rating	Fuse Mounting Type ①	Voltage BIL (kV)	Mounting (Including Live Parts, End Fittings) ②		Live Parts (Including End Fittings) ②	End Fittings (Disconnect Only)
			Porcelain Insulator Catalog Number	Glass-Polyester Insulator Catalog Number		
0.5–2	Non-disconnect	95	15CLPT-PNM-A	15CLPT-GNM-A	CLPT-NL	—
	Disconnect	95	15CLPT-PDM-A	15CLPT-GDM-A	CLPT-DL	CLPT-DF
3–10	Non-disconnect	95	15CLPT-PNM-B	15CLPT-GNM-B	CLPT-NL	CLPT-DF
	Disconnect	95	15CLPT-PDM-B	15CLPT-GDM-B	CLPT-DL	—

Notes

- ① See Page V14-T3-38 for diagram of typical mounting.
- ② End fittings supplied only when required.

CLPT Type Current Limiting Fuses 25.5 kV Maximum (23.0 kV Nominal)

Current Rating (Amperes)	Interrupting Rating rms (kA Sym.)	Diameter Approximate	Clip Center Dimensions in Inches (mm)	Length (mm)	Approximate Shipping Weight Lbs (kg)	Performance Curves			Catalog Number
						Minimum Melting Time	Total Clearing Time	Peak Let-Through Current	
0.5E	44	1.60 (40.6)	16.10 (408.9)	17.60 (447.0)	2 (0.91)	TC56353208	TC56353308	TC63933901	25CLPT-.5E
1E	44	1.60 (40.6)	16.10 (408.9)	17.60 (447.0)	2 (0.91)	TC56353208	TC56353308	TC63933901	25CLPT-1E

CLPT Type Mountings and Hardware 25.5 kV Maximum (23.0 kV Nominal)

Ampere Rating	Fuse Mounting Type ^①	Voltage BIL (kV)	Mounting (Including Live Parts, End Fittings) ^②		Live Parts (Including End Fittings) ^②	End Fittings (Disconnect Only)
			Porcelain Insulator Catalog Number	Glass-Polyester Insulator Catalog Number	Catalog Number	Catalog Number
0.5E–1E	Non-disconnect	150	25CLPT-PNM-A	—	25CLPT-NL	—
	Disconnect	150	25CLPT-PDM-A	—	25CLPT-DL	CLPT-DF

CLPT Type Current Limiting Fuses 38.0 kV Maximum (34.5 kV Nominal)

Current Rating (Amperes)	Interrupting Rating rms (kA Sym.)	Diameter Approximate	Clip Center Dimensions in Inches (mm)	Length (mm)	Approximate Shipping Weight Lbs (kg)	Performance Curves			Catalog Number
						Minimum Melting Time	Total Clearing Time	Peak Let-Through Current	
0.5E	44	1.60 (40.6)	17.10 (434.3)	18.60 (472.4)	2 (0.91)	TC56353208	TC56353308	TC63933901	38CLPT-.5E

CLPT Type Mountings and Hardware 38.0 kV Maximum (34.5 kV Nominal)

Ampere Rating	Fuse Mounting Type ^①	Voltage BIL (kV)	Mounting (Including Live Parts, End Fittings) ^②		Live Parts (Including End Fittings) ^②	End Fittings (Disconnect Only)
			Porcelain Insulator Catalog Number	Glass-Polyester Insulator Catalog Number	Catalog Number	Catalog Number
0.5E	Disconnect	—	Not applicable	Not applicable	25CLPT-NL	CLPT-DF
	Non-disconnect	—	Not applicable	Not applicable	25CLPT-DL	—

Notes

^① See **Page V14-T3-38** for diagram of typical mounting.

^② End fittings supplied only when required.

3.5

Current Limiting Fuses

CLPT and NCLPT Type Fuses

Mounting Details

Approximate Dimensions in Inches (mm)

CLPT and NCLPT Type Disconnect Mountings

3

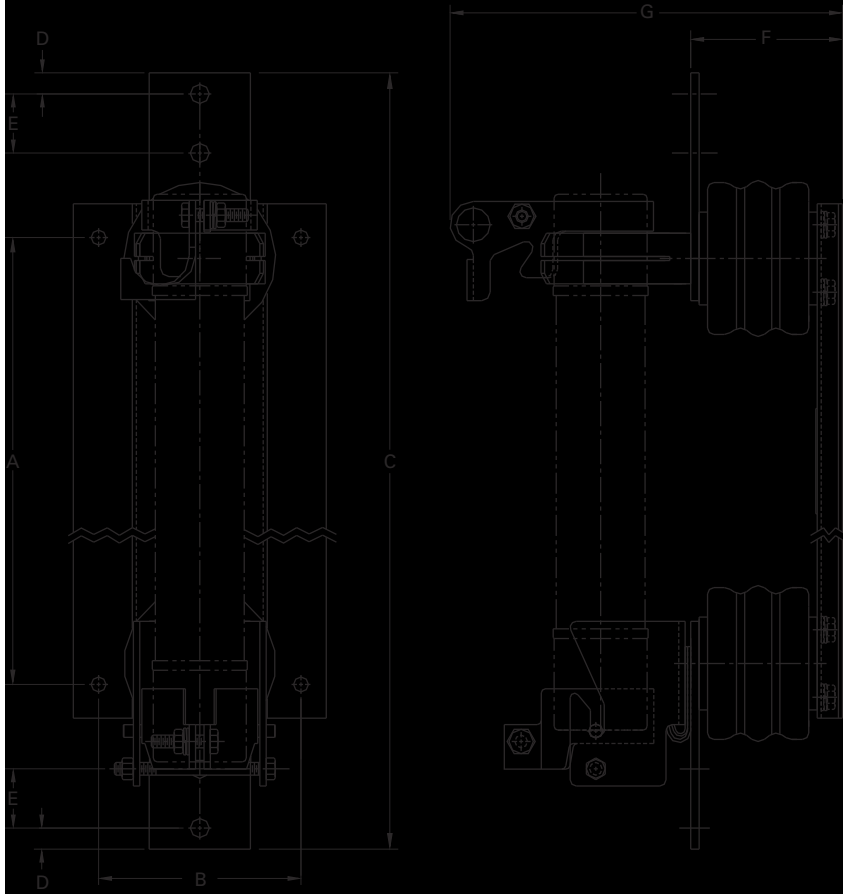

Catalog Number	Hole Centers A	Hole Centers B	Overall Length C	Hole Inset D	Hole Centers E	Contact Height F	Overall Height G	BIL Rating
5CLPT-GDM-A	9.37 (238.0)	6.00 (152.4)	18.63 (473.2)	0.75 (19.0)	1.75 (44.4)	4.50 (114.3)	9.56 (242.8)	60
5CLPT-PDM-A	9.37 (238.0)	6.00 (152.4)	18.63 (473.2)	0.75 (19.0)	1.75 (44.4)	4.50 (114.3)	9.56 (242.8)	60
8CLPT-GDM-A	9.37 (238.0)	6.00 (152.4)	18.63 (473.2)	0.75 (19.0)	1.75 (44.4)	7.00 (177.8)	12.06 (306.3)	75
8CLPT-GDM-B	9.37 (238.0)	6.00 (152.4)	18.63 (473.2)	0.75 (19.0)	1.75 (44.4)	7.00 (177.8)	12.06 (306.3)	75
8CLPT-PDM-A	12.74 (323.6)	6.00 (152.4)	22.00 (558.8)	0.75 (19.0)	1.75 (44.4)	7.00 (177.8)	12.06 (306.3)	75
8CLPT-PDM-B	12.74 (323.6)	6.00 (152.4)	22.00 (558.8)	0.75 (19.0)	1.75 (44.4)	7.00 (177.8)	12.06 (306.3)	75
15CLPT-GDM-A	12.74 (323.6)	6.00 (152.4)	22.00 (558.8)	0.75 (19.0)	1.75 (44.4)	7.00 (177.8)	12.06 (306.3)	95
15CLPT-PDM-A	12.74 (323.6)	6.00 (152.4)	22.00 (558.8)	0.75 (19.0)	1.75 (44.4)	7.00 (177.8)	12.06 (306.3)	95
15CLPT-GDM-B	17.46 (443.5)	6.00 (152.4)	26.63 (676.4)	0.75 (19.0)	1.75 (44.4)	7.00 (177.8)	12.06 (306.3)	95
15CLPT-PDM-B	17.46 (443.5)	6.00 (152.4)	26.63 (676.4)	0.75 (19.0)	1.75 (44.4)	7.00 (177.8)	12.06 (306.3)	95
15CLPY-HPDM-A	12.74 (323.6)	6.00 (152.4)	22.00 (558.8)	0.75 (19.0)	1.75 (44.4)	8.50 (215.9)	13.56 (344.4)	110
15CLPT-HPDM-B	17.46 (443.5)	6.00 (152.4)	26.63 (676.4)	0.75 (19.0)	1.75 (44.4)	8.50 (215.9)	13.56 (344.4)	110
25CLPT-PNM-A	19.12 (485.6)	7.00 (177.8)	26.63 (676.4)	0.75 (19.0)	1.75 (44.4)	12.00 (304.8)	17.06 (433.3)	150

Approximate Dimensions in Inches (mm)

CLPT and NCLPT Type Non-Disconnect Mountings

3

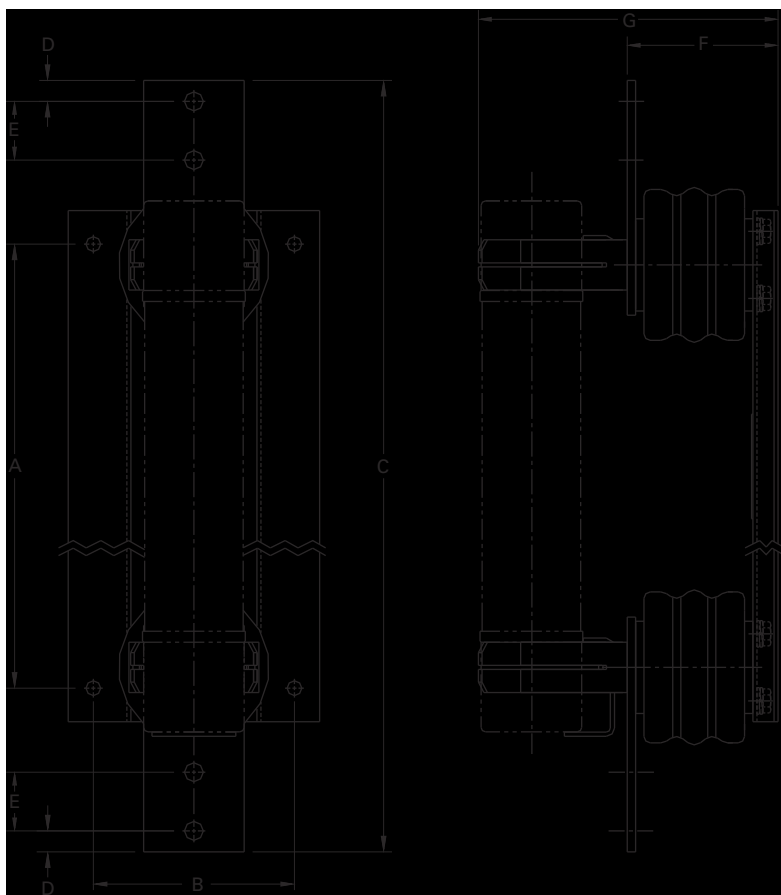

Catalog Number	Hole Centers A	Hole Centers B	Overall Length C	Hole Inset D	Hole Centers E	Contact Height F	Overall Height G	BIL Rating
5CLPT-GNM-A	9.37 (238.0)	6.00 (152.4)	18.63 (473.2)	0.75 (19.0)	1.75 (44.4)	4.50 (114.3)	6.94 (176.2)	60
5CLPT-PNM-A	9.37 (238.0)	6.00 (152.4)	18.63 (473.2)	0.75 (19.0)	1.75 (44.4)	4.50 (114.3)	6.94 (176.2)	60
8CLPT-GNM-A	9.37 (238.0)	6.00 (152.4)	18.63 (473.2)	0.75 (19.0)	1.75 (44.4)	7.00 (177.8)	9.44 (239.8)	75
8CLPT-PNM-A	9.37 (238.0)	6.00 (152.4)	18.63 (473.2)	0.75 (19.0)	1.75 (44.4)	7.00 (177.8)	9.44 (239.8)	75
8CLPT-GNM-B	12.75 (323.8)	6.00 (152.4)	22.00 (558.8)	0.75 (19.0)	1.75 (44.4)	7.00 (177.8)	9.44 (239.8)	75
8CLPT-PNM-B	12.75 (323.8)	6.00 (152.4)	22.00 (558.8)	0.75 (19.0)	1.75 (44.4)	7.00 (177.8)	9.44 (239.8)	75
15CLPT-GNM-A	12.74 (323.6)	6.00 (152.4)	22.00 (558.8)	0.75 (19.0)	1.75 (44.4)	7.00 (177.8)	9.44 (239.8)	95
15CLPT-PNM-A	12.74 (323.6)	6.00 (152.4)	22.00 (558.8)	0.75 (19.0)	1.75 (44.4)	7.00 (177.8)	9.44 (239.8)	95
15CLPT-HPNM-A	12.74 (323.6)	6.00 (152.4)	22.00 (558.8)	0.75 (19.0)	1.75 (44.4)	8.50 (215.9)	10.94 (277.9)	110
15CLPT-GNM-B	17.46 (443.5)	6.00 (152.4)	26.63 (676.4)	0.75 (19.0)	1.75 (44.4)	7.00 (177.8)	9.44 (239.8)	95
15CLPT-PNM-B	17.46 (443.5)	6.00 (152.4)	26.63 (676.4)	0.75 (19.0)	1.75 (44.4)	7.00 (177.8)	9.44 (239.8)	95
15CLPT-HPNM-B	17.46 (443.5)	6.00 (152.4)	26.63 (676.4)	0.75 (19.0)	1.75 (44.4)	8.50 (215.9)	10.94 (277.9)	110
25CLPT-PNM-A	19.12 (485.6)	7.00 (177.8)	26.63 (676.4)	0.75 (19.0)	1.75 (44.4)	12.00 (304.8)	14.43 (367.0)	150
38CLPT-PNM-A	19.12 (485.6)	7.00 (177.8)	26.63 (676.4)	0.75 (19.0)	1.75 (44.4)	12.00 (304.8)	14.43 (367.0)	150

3.6

Current Limiting Fuses

ACLS, BCLS, CLS, HCLS and NCLS Type Fuses

Motor Start Fuses



3

Contents

Description

Page

ACLS, BCLS, CLS, HCLS and NCLS Type Fuses	
UL Component Recognition	V14-T3-51
Ratings and Selection	V14-T3-51
Catalog Number Selection	V14-T3-51
Product Selection	V14-T3-59
Dimensions	V14-T3-63

ACLS, BCLS, CLS, HCLS and NCLS Type Fuses

Product Description

Eaton’s CLS current limiting fuses are used in conjunction with medium voltage motor starters to provide short-circuit protection for individual motor circuits.

Contactors in motor starting equipment protect the equipment from over-currents due to starting, stalling and plugging while current limiting fuses provide short-circuit protection only.

Duty cycles of fuses used in medium voltage motor starters are characterized by the frequent application of high overloads such as motor starting currents. Motor starter fuses, therefore, must be designed to withstand the consequent frequent severe heating and cooling cycles without fatigue failures. CLS type fuses have such a construction. The element designs used are not sensitive to low currents, and have “fatigue proof” features to provide highly uniform flexing of elements during heating cycles.

The mounting possibilities for CLS type current limiting fuses are shown on **Page V14-T3-64**, with disconnect type being the predominant approach.

CLS Features

CLS type current limiting fuses offer a number of advantages over a number of other designs. During the selection process, consider the following:

- **Quiet Safe Operation:** CLS type current limiting fuses are designed for silent operation and elimination of flame discharges when the fuse operates
- **Easy to Identify Operated Fuse:** CLS type current limiting fuses are equipped with an indicator that will protrude indicating when a fuse has operated
- **Space Economy:** Because the design of these fuses has eliminated flame or gas discharge, the need for exhaust control devices, vents and reinforcing is eliminated

- **Complete Protection Provided:** CLS type current limiting fuses ensure positive interruption of high fault currents. The fuse limits the magnitude of the electromechanical stresses in the protected apparatus. They also limit the arc voltage to considerably less than three times the nominal circuit voltage
- **Fatigue Proof:** Controlled “crimping” of the silver elements during fuse manufacture permits CLS type current limiting fuses to withstand severe duty cycling without failure

Construction

CLS type current limiting fuses are of basically inorganic construction. The only organic material used is a high temperature glass-resin outer casing and the plastic indicator. The fuse elements are pure silver and are crimped at controlled locations along the active length to increase the strength of the element, and to uniformly distribute mechanical expansion and prevent fatigue failure due to severe cycling duties. Element design combines maximum load carrying ability with the most favorable short circuit interruption characteristics. These fuses are filled with a high purity silica sand with controlled grain size.

UL® Component Recognition

Underwriters Laboratories has witnessed testing on and recognizes certain styles of 5CLS and 5ACLS fuses. These fuses carry the “reversed UR” designation. CLS type current limiting motor start fuses manufactured prior to 1975 were not identified by an “R” designation. However, these fuses can be used with or replaced by newer fuses with “R” designations as indicated below.

Ratings and Selection

When a decision has been made to use current limiting fuses, the minimum amount of information required to make the proper selection is:

- Voltage rating
- Current rating
- Interrupting rating
- Mounting method
 - Non-disconnect mounting
 - Disconnect mounting
 - Clip-lock mounting
 - Direct bolt-in mounting
 - Live parts only
 - No required mounting

Refer to **Pages V14-T3-52 to V14-T3-62** for assistance in selecting the correct fuse catalog number.

These types of fuses are used in conjunction with high voltage motor starters to provide short-circuit protection for individual motors. There are specific rules governing the selection of the required fuse continuous rating.

The current limiting fuse application notes earlier in this publication offer additional information about this type of application.

When selecting the appropriate fuse for a new installation, keep in mind that one fuse unit and one compatible mounting is required for each phase.

Catalog Number Selection

CLS Fuse Units

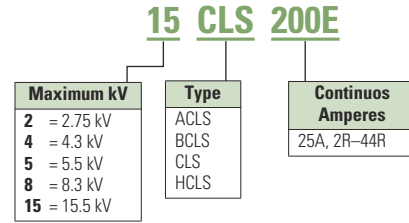

3.6

Current Limiting Fuses

ACLS, BCLS, CLS, HCLS and NCLS Type Fuses

CLS Type Current Limiting Fuses

Max. Design Voltage (kV)	Current Rating (A)	"R" Designation	Catalog Number	Barrel Number	Interrupting Rating rms (kA Sym.)	Diameter (Inches)	Clip Center (Inches)	Length (Inches)	Approx. Shipping Weight (Lbs)	Catalog Number		Performance Curves		
										Live Parts ①	End Fittings ②	Minimum Melting Time	Total Clearing Time	Peak Let-Through Current
2.54	25	—	2CLS-25	1	50	3	7	10.8	7	CLE-NL-D	—	TC66664702	TC66664704	TC66700202
	70	2R	2CLS-2R	1	50	3	7	10.8	7	CLE-DL-D	CLE-DF-D			
	100	3R	2CLS-3R	1	50	3	7	10.8	7					
	130	4R	2CLS-4R	1	50	3	7	10.8	7					
	150	5R	2CLS-5R	1	50	3	7	10.8	7					
	170	6R	2CLS-6R	1	50	3	7	10.8	7					
	200	9R	2CLS-9R	1	50	3	7	10.8	7					
	230	12R	2CLS-12R	1	50	3	7	10.8	7					
	390	18R	2CLS-18R	2	50	3	7	10.8	16	CLE-NL-E	—	TC66664702	TC66664704	TC66700202
	450	24R	2CLS-24R	2	50	3	7	10.8	16	CLE-DL-E	CLE-DF-E			
	25	—	2ACLS-25	1	50	3	—	10.8	7	—		TC66664702	TC66664704	TC66700202
	70	2R	2ACLS-2R	1	50	3	—	10.8	7					
	100	3R	2ACLS-3R	1	50	3	—	10.8	7					
	130	4R	2ACLS-4R	1	50	3	—	10.8	7					
	150	5R	2ACLS-5R	1	50	3	—	10.8	7					
	170	6R	2ACLS-6R	1	50	3	—	10.8	7					
	200	9R	2ACLS-9R	1	50	3	—	10.8	7					
	230	12R	2ACLS-12R	1	50	3	—	10.8	7					
	390	18R	2ACLS-18R	2	50	3	—	10.8	16					
	450	24R	2ACLS-24R	2	50	3	—	10.8	16					
25	—	2BCLS-25	1	50	3	—	—	8	—		TC66664702	TC66664704	TC66700202	
70	2R	2BCLS-2R	1	50	3	—	—	8						
100	3R	2BCLS-3R	1	50	3	—	—	8						
130	4R	2BCLS-4R	1	50	3	—	—	8						
150	5R	2BCLS-5R	1	50	3	—	—	8						
170	6R	2BCLS-6R	1	50	3	—	—	8						
200	9R	2BCLS-9R	1	50	3	—	—	8						
230	12R	2BCLS-12R	1	50	3	—	—	8						
390	18R	2BCLS-18R	2	50	3	—	—	17						
450	24R	2BCLS-24R	2	50	3	—	—	17						
25	—	2HCLS-25	1	50	3	—	10.8	7	—		TC66664702	TC66664704	TC66700202	
70	2R	2HCLS-2R	1	50	3	—	10.8	7						
100	3R	2HCLS-3R	1	50	3	—	10.8	7						
130	4R	2HCLS-4R	1	50	3	—	10.8	7						
150	5R	2HCLS-5R	1	50	3	—	10.8	7						
170	6R	2HCLS-6R	1	50	3	—	10.8	7						
200	9R	2HCLS-9R	1	50	3	—	10.8	7						
230	12R	2HCLS-12R	1	50	3	—	10.8	7						
390	18R	2HCLS-18R	2	50	3	—	10.8	16						
450	24R	2HCLS-24R	2	50	3	—	10.8	16						

Notes

- ① Includes end fittings.
- ② Disconnect only.

CLS Type Current Limiting Fuses, continued

Max. Design Voltage (kV)	Current Rating (A)	"R" Designation	Catalog Number	Barrel Number	Interrupting Rating rms (kA Sym.)	Diameter (Inches)	Clip Center (Inches)	Length (Inches)	Approx. Shipping Weight (Lbs)	Catalog Number		Performance Curves		Peak Let-Through Current
										Live Parts ①	End Fittings ②	Minimum Melting Time	Total Clearing Time	
5.5	30	—	5CLS-30	1	50	3	12	15.9	8	CLE-NL-D CLE-DL-D	—	TC66690602	TC66690702	TC66700203
	70	2R	5CLS-2R	1	50	3	12	15.9	8					
	100	3R	5CLS-3R	1	50	3	12	15.9	8					
	130	4R	5CLS-4R	1	50	3	12	15.9	8					
	150	5R	5CLS-5R	1	50	3	12	15.9	8					
	170	6R	5CLS-6R	1	50	3	12	15.9	8					
	200	9R	5CLS-9R	1	50	3	12	15.9	8					
	230	12R	5CLS-12R	1	50	3	12	15.9	8					
	390	18R	5CLS-18R	2	50	3	12	15.9	17					
	450	24R	5CLS-24R	2	50	3	12	15.9	17					
5.08	30	—	5ACLS-30	1	50	3	—	15.9	8	—	—	TC66690602	TC66690702	TC66700203
	70	2R	5ACLS-2R	1	50	3	—	15.9	8					
	100	3R	5ACLS-3R	1	50	3	—	15.9	8					
	130	4R	5ACLS-4R	1	50	3	—	15.9	8					
	150	5R	5ACLS-5R	1	50	3	—	15.9	8					
	170	6R	5ACLS-6R	1	50	3	—	15.9	8					
	200	9R	5ACLS-9R	1	50	3	—	15.9	8					
	230	12R	5ACLS-12R	1	50	3	—	15.9	8					
	390	18R	5ACLS-18R	2	50	3	—	15.9	17					
	450	24R	5ACLS-24R	2	50	3	—	15.9	17					
4.3	480	26R	4ACLS-26R	2	50	3	—	15.9	17					
5.08	30	—	5BCLS-30	1	50	3	—	—	8	—	—	TC66690602	TC66690702	TC66700203
	70	2R	5BCLS-2R	1	50	3	—	—	8					
	100	3R	5BCLS-3R	1	50	3	—	—	8					
	130	4R	5BCLS-4R	1	50	3	—	—	8					
	150	5R	5BCLS-5R	1	50	3	—	—	8					
	170	6R	5BCLS-6R	1	50	3	—	—	8					
	200	9R	5BCLS-9R	1	50	3	—	—	8					
	230	12R	5BCLS-12R	1	50	3	—	—	8					
	390	18R	5BCLS-18R	2	50	3	—	—	17					
	450	24R	5BCLS-24R	2	50	3	—	—	17					
4.3	480	26R	4BCLS-26R	2	50	3	—	—	17					
5.08	30	—	5HCLS-30	1	50	3	—	15.9	8	—	—	TC66690602	TC66690702	TC66700203
	70	2R	5HCLS-2R	1	50	3	—	15.9	8					
	100	3R	5HCLS-3R	1	50	3	—	15.9	8					
	130	4R	5HCLS-4R	1	50	3	—	15.9	8					
	150	5R	5HCLS-5R	1	50	3	—	15.9	8					
	170	6R	5HCLS-6R	1	50	3	—	15.9	8					
	200	9R	5HCLS-9R	1	50	3	—	15.9	8					
	230	12R	5HCLS-12R	1	50	3	—	15.9	8					
	390	18R	5HCLS-18R	2	50	3	—	15.9	17					
	450	24R	5HCLS-24R	2	50	3	—	15.9	17					

Notes

- ① Includes end fittings.
- ② Disconnect only.

3.6

Current Limiting Fuses

ACLS, BCLS, CLS, HCLS and NCLS Type Fuses

CLS Type Current Limiting Fuses, continued

Max. Design Voltage (kV)	Current Rating (A)	"R" Designation	Catalog Number	Barrel Number	Interrupting Rating rms (kA Sym.)	Diameter (Inches)	Clip Center (Inches)	Length (Inches)	Approx. Shipping Weight (Lbs)	Catalog Number		Performance Curves		
										Live Parts ①	End Fittings ②	Minimum Melting Time	Total Clearing Time	Peak Let-Through Current
5.08	70	2R	5CLS70-2R	2	50	3	—	—	20	—	—	TC66690602	TC66690702	TC66700203
	100	3R	5CLS70-3R	2	50	3	—	—	20	—	—	—	—	—
	130	4R	5CLS70-4R	2	50	3	—	—	20	—	—	—	—	—
	150	5R	5CLS70-5R	2	50	3	—	—	20	—	—	—	—	—
	170	6R	5CLS70-6R	2	50	3	—	—	20	—	—	—	—	—
	200	9R	5CLS70-9R	2	50	3	—	—	20	—	—	—	—	—
	230	12R	5CLS70-12R	2	50	4	—	—	40	—	—	—	—	—
	390	18R	5CLS70-18R	2	50	4	—	—	40	—	—	—	—	—
	450	24R	5CLS70-24R	2	50	4	—	—	40	—	—	—	—	—
	600	32R	5CLS70-32R	2	50	4	—	—	40	—	—	—	—	—
	650	36R	5CLS70-36R	2	50	4	—	—	40	—	—	—	—	—
	700	44R	5CLS70-44R	2	50	4	—	—	40	—	—	—	—	—
	5.5	70	2R	5LCLS-2R	1	50	3	14	17.9	11	CLE-NL-D	—	TC51285302	TC51285402
100		3R	5LCLS-3R	1	50	3	14	17.9	11	CLE-DL-D	CLE-DF-D	—	—	—
130		4R	5LCLS-4R	1	50	3	14	17.9	11	CLE-DF-D	CLE-DF-D	—	—	—
150		5R	5LCLS-5R	1	50	3	14	17.9	11	—	—	—	—	—
170		6R	5LCLS-6R	1	50	3	14	17.9	11	—	—	—	—	—
200		9R	5LCLS-9R	1	50	3	14	17.9	11	—	—	—	—	—
230		12R	5LCLS-12R	1	50	3	14	17.9	11	—	—	—	—	—
450		24R	5LCLS-24R	2	50	3	14	17.9	22	—	—	—	—	—
8.3	70	2R	8CLS-2R	1	50	3	12	15.9	7	CLE-NL-D	—	TC66700602	TC66700702	TC66700205
	100	3R	8CLS-3R	1	50	3	12	15.9	7	CLE-DL-D	CLE-DF-D	—	—	—
	130	4R	8CLS-4R	1	50	3	12	15.9	7	—	—	—	—	—
	150	5R	8CLS-5R	1	50	3	12	15.9	7	—	—	—	—	—
	170	6R	8CLS-6R	1	50	3	12	15.9	7	—	—	—	—	—
	200	9R	7CLS-9R	1	50	3	12	15.9	7	—	—	—	—	—
	230	12R	7CLS-12R	1	50	3	12	15.9	7	—	—	—	—	—
7.2	390	18R	7CLS-18R	2	50	3	12	15.9	16	CLE-NL-E	—	TC66700602	TC66700702	TC66700205
	450	24R	7CLS-24R	2	50	3	12	15.9	16	CLE-DL-E	CLE-DF-E	—	—	—
8.3	70	2R	7BCLS-2R	1	50	3	—	—	—	—	—	TC66700602	TC66700702	TC66740205
	100	3R	7BCLS-3R	1	50	3	—	—	—	—	—	—	—	—
	130	4R	7BCLS-4R	1	50	3	—	—	—	—	—	—	—	—
	150	5R	7BCLS-5R	1	50	3	—	—	—	—	—	—	—	—
	170	6R	7BCLS-6R	1	50	3	—	—	—	—	—	—	—	—
	200	9R	7BCLS-9R	1	50	3	—	—	—	—	—	—	—	—
	230	12R	7BCLS-12R	1	50	3	—	—	—	—	—	—	—	—
7.2	390	18R	7BCLS-18R	2	50	3	—	—	—	—	—	—	—	—
	450	24R	7BCLS-24R	2	50	3	—	—	—	—	—	—	—	—

Notes

① Includes end fittings.

② Disconnect only.

CLS Type Current Limiting Fuses, continued

Max. Design Voltage (kV)	Current Rating (A)	"R" Designation	Catalog Number	Barrel Number	Interrupting Rating rms (kA Sym.)	Diameter (Inches)	Clip Center (Inches)	Length (Inches)	Approx. Shipping Weight (Lbs)	Catalog Number		Performance Curves		
										Live Parts ①	End Fittings ②	Minimum Melting Time	Total Clearing Time	Peak Let-Through Current
8.3	70	2R	8ACLS-2R	1	50	3	—	15.9	8	—	—	TC66700602	TC66700702	TC66740205
	100	3R	8ACLS-3R	1	50	3	—	15.9	8	—	—	—	—	—
	130	4R	8ACLS-4R	1	50	3	—	15.9	8	—	—	—	—	—
	150	5R	8ACLS-5R	1	50	3	—	15.9	8	—	—	—	—	—
	170	6R	8ACLS-6R	1	50	3	—	15.9	8	—	—	—	—	—
7.2	200	9R	7ACLS-9R	1	50	3	—	15.9	8	—	—	—	—	—
	230	12R	7ACLS-12R	1	50	3	—	15.9	8	—	—	—	—	—
	390	18R	7ACLS-18R	2	50	3	—	15.9	17	—	—	—	—	—
	450	24R	7ACLS-24R	2	50	3	—	15.9	17	—	—	—	—	—
	450	24R	7CLS70-24R	2	50	3	—	—	20	—	—	—	—	—
	650	36R	7CLS70-36R	3	50	3	—	—	30	—	—	—	—	—
	700	44R	7CLS70-44R	2	50	4	—	—	40	—	—	—	—	—
8.3	15	—	8CLS-15	1	50	3	14	17.9	11	CLE-NL-D	—	TC66664202	TC66664302	TC66679802
	30	—	8CLS-30	1	50	3	14	17.9	11	CLE-DL-D	CLS-DF-D	—	—	—
	60	—	8CLS-60	1	50	3	14	17.9	11	—	—	—	—	—
	70	—	8CLS-70	1	50	3	14	17.9	11	—	—	—	—	—
	90	—	8CLS-90	1	50	3	14	17.9	11	—	—	—	—	—
	110	—	8CLS-110	1	50	3	14	17.9	11	—	—	—	—	—
	125	—	8CLS-125	1	50	3	14	17.9	11	—	—	—	—	—
	150	—	8CLS-150	2	50	3	14	17.9	22	CLE-NL-E	—	TC66664202	TC66664302	TC66679802
	200	—	8CLS-200	2	50	3	14	17.9	22	CLE-DL-E	CLE-DF-E	—	—	—
	225	—	8CLS-225	2	50	3	14	17.9	22	—	—	—	—	—

Notes

- ① Includes end fittings.
- ② Disconnect only.

3.6

Current Limiting Fuses

ACLS, BCLS, CLS, HCLS and NCLS Type Fuses

CLS Type Current Limiting Fuses—Mounting

Maximum Design Voltage (kV)	Current Rating (Amperes)	"R" Designation	Catalog Number	Mounting (Includes Live Parts, End Fittings)			
				Type	Voltage (BIL) kV	Catalog Number Porcelain	Catalog Number Glass-Polyester
2.54	25	—	2CLS-25	Non-disconnect	60	2CLE-PNM-D	2CLE-GNM-D
	70	2R	2CLS-2R	Disconnect	60	2CLE-PDM-D	2CLE-GDM-E
	100	3R	2CLS-3R				
	130	4R	2CLS-4R				
	150	5R	2CLS-5R				
	170	6R	2CLS-6R				
	200	9R	2CLS-9R				
	230	12R	2CLS-12R				
	390	18R	2CLS-18R	Non-disconnect	60	2CLE-PNM-E	2CLE-GNM-E
	450	24R	2CLS-24R	Disconnect	60	2CLE-PDME	2CLE-GDM-E
	25	—	2ACLS-25	For use with Amgard 400A motor starters			
	70	2R	2ACLS-2R				
	100	3R	2ACLS-3R				
	130	4R	2ACLS-4R				
	150	5R	2ACLS-5R				
	170	6R	2ACLS-6R				
	200	9R	2ACLS-9R				
	230	12R	2ACLS-12R				
	390	18R	2ACLS-18R				
	450	24R	2ACLS-24R				
25	—	2BCLS-25	Bolt-in				
70	2R	2BCLS-2R					
100	3R	2BCLS-3R					
130	4R	2BCLS-4R					
150	5R	2BCLS-5R					
170	6R	2BCLS-6R					
200	9R	2BCLS-9R					
230	12R	2BCLS-12R					
390	18R	2BCLS-18R					
450	24R	2BCLS-24R					
25	—	2HCLS-25	Hermetically sealed fuses for use with Amgard 400A motor starters				
70	2R	2HCLS-2R					
100	3R	2HCLS-3R					
130	4R	2HCLS-4R					
150	5R	2HCLS-5R					
170	6R	2HCLS-6R					
200	9R	2HCLS-9R					
230	12R	2HCLS-12R					
390	18R	2HCLS-18R					
450	24R	2HCLS-24R					
5.5	30	—	5CLS-30	Non-disconnect	60	5HLE-PNM-D	5HLE-GNM-D
	70	2R	5CLS-2R	Disconnect	60	5HLE-PDM-D	5HLE-GDM-E
	100	3R	5CLS-3R				
	130	4R	5CLS-4R				
	150	5R	5CLS-5R				
	170	6R	5CLS-6R				
	200	9R	5CLS-9R				
230	12R	5CLS-12R					

CLS Type Current Limiting Fuses—Mounting, continued

Maximum Design Voltage (kV)	Current Rating (Amperes)	"R" Designation	Catalog Number	Mounting (Includes Live Parts, End Fittings)			
				Type	Voltage (BIL) kV	Catalog Number Porcelain	Catalog Number Glass-Polyester
5.5	390	18R	5CLS-18R	Non-disconnect	60	5HLE-PNM-E	5HLE-GNM-E
	450	24R	5CLS-24R	Disconnect	60	5HLE-PDME	5HLE-GDM-E
5.08	30	—	5ACLS-30	For use with Ampgard 400A motor starters			
	70	2R	5ACLS-2R				
	100	3R	5ACLS-3R				
	130	4R	5ACLS-4R				
	150	5R	5ACLS-5R				
	170	6R	5ACLS-6R				
	200	9R	5ACLS-9R				
	230	12R	5ACLS-12R				
	390	18R	5ACLS-18R				
	450	24R	5ACLS-24R				
4.3	480	26R	4ACLS-26R				
5.08	30	—	5BCLS-30	Bolt-in			
	70	2R	5BCLS-2R				
	100	3R	5BCLS-3R				
	130	4R	5BCLS-4R				
	150	5R	5BCLS-5R				
	170	6R	5BCLS-6R				
	200	9R	5BCLS-9R				
	230	12R	5BCLS-12R				
	390	18R	5BCLS-18R				
	450	24R	5BCLS-24R				
4.3	480	26R	4BCLS-26R				
5.08	30	—	5HCLS-30	Hermetically sealed for use with Ampgard 400A motor starters			
	70	2R	5HCLS-2R				
	100	3R	5HCLS-3R				
	130	4R	5HCLS-4R				
	150	5R	5HCLS-5R				
	170	6R	5HCLS-6R				
	200	9R	5HCLS-9R				
	230	12R	5HCLS-12R				
	390	18R	5HCLS-18R				
	450	24R	5HCLS-24R				
	70	2R	5CLS70-2R	For use with Ampgard 800A motor starters			
	100	3R	5CLS70-3R				
	130	4R	5CLS70-4R				
	150	5R	5CLS70-5R				
	170	6R	5CLS70-6R				
	200	9R	5CLS70-9R				
	230	12R	5CLS70-12R				
390	18R	5CLS70-18R					
450	24R	5CLS70-24R					
600	32R	5CLS70-32R					
650	36R	5CLS70-36R					
700	44R	5CLS70-44R					

3.6

Current Limiting Fuses

ACLS, BCLS, CLS, HCLS and NCLS Type Fuses

CLS Type Current Limiting Fuses—Mounting, continued

Maximum Design Voltage (kV)	Current Rating (Amperes)	"R" Designation	Catalog Number	Mounting (Includes Live Parts, End Fittings)			
				Type	Voltage (BIL) kV	Catalog Number Porcelain	Catalog Number Glass-Polyester
5.5	70	2R	5LCLS-2R	Non-disconnect	60	5CLE-PNM-D	5CLE-GNM-D
	100	3R	5LCLS-3R	Disconnect	60	5CLE-PDM-D	5CLE-GDM-D
	130	4R	5LCLS-4R	Disconnect	75	8CLE-PDM-D	8CLE-GDM-D
	150	5R	5LCLS-5R				
	170	6R	5LCLS-6R				
	200	9R	5LCLS-9R				
	230	12R	5LCLS-12R				
	390	18R	5LCLS-18R				
	450	24R	5LCLS-24R				
8.3	70	2R	8CLS-2R	Non-disconnect	75	8HLE-PNM-D	8HLE-GNM-D
	100	3R	8CLS-3R	Disconnect	75	8HLE-PDM-D	8HLE-GDM-D
	130	4R	8CLS-4R				
	150	5R	8CLS-5R				
	170	6R	8CLS-6R				
	200	9R	7CLS-9R				
	230	12R	7CLS-12R				
7.2	390	18R	7CLS-18R	Non-disconnect	75	8HLE-PDM-E	8HLE-GNM-E
	450	24R	7CLS-24R	Disconnect	75	8HLE-PDM-E	8HLE-GDM-E
8.3	70	2R	7BCLS-2R	Bolt-in			
	100	3R	7BCLS-3R				
	130	4R	7BCLS-4R				
	150	5R	7BCLS-5R				
	170	6R	7BCLS-6R				
	200	9R	7BCLS-9R				
	230	12R	7BCLS-12R				
7.2	390	18R	7BCLS-18R				
	450	24R	7BCLS-24R				
8.3	70	2R	8ACLS-2R	For use with Ampgard 400A motor starters			
	100	3R	8ACLS-3R				
	130	4R	8ACLS-4R				
	150	5R	8ACLS-5R				
	170	6R	8ACLS-6R				
7.2	200	9R	7ACLS-9R				
	230	12R	7ACLS-12R				
	390	18R	7ACLS-18R				
	450	24R	7ACLS-24R				
	450	24R	7CLS70-24R	For use with Ampgard 800A motor starters			
	650	36R	7CLS70-36R				
	700	44R	7CLS70-44R				
8.3	15	—	8CLS-15	Non-disconnect	75	8CLE-PNM-D	8CLE-GNM-D
	30	—	8CLS-30	Disconnect	75	8CLE-PDM-D	8CLE-GDM-D
	60	—	8CLS-60				
	70	—	8CLS-70				
	90	—	8CLS-90				
	110	—	8CLS-110				
	125	—	8CLS-125				
	150	—	8CLS-150	Non-disconnect	75	8CLE-PNM-E	8CLE-GNM-E
	200	—	8CLS-200	Disconnect	75	8CLE-PDM-E	8CLE-GDM-E
	225	—	8CLS-225				

Product Selection

CLS Type

CLS Type Current Limiting Fuses

Maximum Design Voltage (kV)	Current Rating (Amperes)	"R" Designation	Barrel Number	Interrupting Rating rms (kA Sym.)	Diameter		Clip	Length	Approximate Shipping Weight Lbs (kg)	Performance Curves		Peak Let-Through Current	Catalog Number
					Approximate	Center	Dimensions in Inches (mm)			Minimum Melting Time	Total Clearing Time		
2.54	25	—	1	50	3.00 (76.2)	7.00 (177.8)	10.80 (274.3)	7 (3.18)	TC66664702	TC66664704	TC66700202	2CLS-25	
	70	2R	1	50	3.00 (76.2)	7.00 (177.8)	10.80 (274.3)	7 (3.18)	TC66664702	TC66664704	TC66700202	2CLS-2R	
	100	3R	1	50	3.00 (76.2)	7.00 (177.8)	10.80 (274.3)	7 (3.18)	TC66664702	TC66664704	TC66700202	2CLS-3R	
	130	4R	1	50	3.00 (76.2)	7.00 (177.8)	10.80 (274.3)	7 (3.18)	TC66664702	TC66664704	TC66700202	2CLS-4R	
	150	5R	1	50	3.00 (76.2)	7.00 (177.8)	10.80 (274.3)	7 (3.18)	TC66664702	TC66664704	TC66700202	2CLS-5R	
	170	6R	1	50	3.00 (76.2)	7.00 (177.8)	10.80 (274.3)	7 (3.18)	TC66664702	TC66664704	TC66700202	2CLS-6R	
	200	9R	1	50	3.00 (76.2)	7.00 (177.8)	10.80 (274.3)	7 (3.18)	TC66664702	TC66664704	TC66700202	2CLS-9R	
	230	12R	1	50	3.00 (76.2)	7.00 (177.8)	10.80 (274.3)	7 (3.18)	TC66664702	TC66664704	TC66700202	2CLS-12R	
	390	18R	2	50	3.00 (76.2)	7.00 (177.8)	10.80 (274.3)	16 (7.26)	TC66664702	TC66664704	TC66700202	2CLS-18R	
	450	24R	2	50	3.00 (76.2)	7.00 (177.8)	10.80 (274.3)	16 (7.26)	TC66664702	TC66664704	TC66700202	2CLS-24R	
	25	—	1	50	3.00 (76.2)	Not applicable	10.80 (274.3)	7 (3.18)	TC66664702	TC66664704	TC66700202	2ACLS-25	
	70	2R	1	50	3.00 (76.2)	Not applicable	10.80 (274.3)	7 (3.18)	TC66664702	TC66664704	TC66700202	2ACLS-2R	
	100	3R	1	50	3.00 (76.2)	Not applicable	10.80 (274.3)	7 (3.18)	TC66664702	TC66664704	TC66700202	2ACLS-3R	
	130	4R	1	50	3.00 (76.2)	Not applicable	10.80 (274.3)	7 (3.18)	TC66664702	TC66664704	TC66700202	2ACLS-4R	
	150	5R	1	50	3.00 (76.2)	Not applicable	10.80 (274.3)	7 (3.18)	TC66664702	TC66664704	TC66700202	2ACLS-5R	
	170	6R	1	50	3.00 (76.2)	Not applicable	10.80 (274.3)	7 (3.18)	TC66664702	TC66664704	TC66700202	2ACLS-6R	
	200	9R	1	50	3.00 (76.2)	Not applicable	10.80 (274.3)	7 (3.18)	TC66664702	TC66664704	TC66700202	2ACLS-9R	
	230	12R	1	50	3.00 (76.2)	Not applicable	10.80 (274.3)	7 (3.18)	TC66664702	TC66664704	TC66700202	2ACLS-12R	
	390	18R	2	50	3.00 (76.2)	Not applicable	10.80 (274.3)	16 (7.26)	TC66664702	TC66664704	TC66700202	2ACLS-18R	
	450	24R	2	50	3.00 (76.2)	Not applicable	10.80 (274.3)	16 (7.26)	TC66664702	TC66664704	TC66700202	2ACLS-24R	
	25	—	1	50	3.00 (76.2)	Not applicable	10.80 (274.3)	8 (3.63)	TC66664702	TC66664704	TC66700202	2BCLS-25	
	70	2R	1	50	3.00 (76.2)	Not applicable	10.80 (274.3)	8 (3.63)	TC66664702	TC66664704	TC66700202	2BCLS-2R	
	100	3R	1	50	3.00 (76.2)	Not applicable	10.80 (274.3)	8 (3.63)	TC66664702	TC66664704	TC66700202	2BCLS-3R	
	130	4R	1	50	3.00 (76.2)	Not applicable	10.80 (274.3)	8 (3.63)	TC66664702	TC66664704	TC66700202	2BCLS-4R	
	150	5R	1	50	3.00 (76.2)	Not applicable	10.80 (274.3)	8 (3.63)	TC66664702	TC66664704	TC66700202	2BCLS-5R	
	170	6R	1	50	3.00 (76.2)	Not applicable	10.80 (274.3)	8 (3.63)	TC66664702	TC66664704	TC66700202	2BCLS-6R	
	200	9R	1	50	3.00 (76.2)	Not applicable	10.80 (274.3)	8 (3.63)	TC66664702	TC66664704	TC66700202	2BCLS-9R	
	230	12R	1	50	3.00 (76.2)	Not applicable	10.80 (274.3)	8 (3.63)	TC66664702	TC66664704	TC66700202	2BCLS-12R	
	390	18R	2	50	3.00 (76.2)	Not applicable	10.80 (274.3)	17 (7.72)	TC66664702	TC66664704	TC66700202	2BCLS-18R	
	450	24R	2	50	3.00 (76.2)	Not applicable	10.80 (274.3)	17 (7.72)	TC66664702	TC66664704	TC66700202	2BCLS-24R	
	25	—	1	50	3.00 (76.2)	Not applicable	10.80 (274.3)	7 (3.18)	TC66664702	TC66664704	TC66700202	2HCLS-25	
	70	2R	1	50	3.00 (76.2)	Not applicable	10.80 (274.3)	7 (3.18)	TC66664702	TC66664704	TC66700202	2HCLS-2R	
	100	3R	1	50	3.00 (76.2)	Not applicable	10.80 (274.3)	7 (3.18)	TC66664702	TC66664704	TC66700202	2HCLS-3R	
	130	4R	1	50	3.00 (76.2)	Not applicable	10.80 (274.3)	7 (3.18)	TC66664702	TC66664704	TC66700202	2HCLS-4R	
	150	5R	1	50	3.00 (76.2)	Not applicable	10.80 (274.3)	7 (3.18)	TC66664702	TC66664704	TC66700202	2HCLS-5R	
	170	6R	1	50	3.00 (76.2)	Not applicable	10.80 (274.3)	7 (3.18)	TC66664702	TC66664704	TC66700202	2HCLS-6R	
	200	9R	1	50	3.00 (76.2)	Not applicable	10.80 (274.3)	7 (3.18)	TC66664702	TC66664704	TC66700202	2HCLS-9R	
	230	12R	1	50	3.00 (76.2)	Not applicable	10.80 (274.3)	7 (3.18)	TC66664702	TC66664704	TC66700202	2HCLS-12R	
	390	18R	2	50	3.00 (76.2)	Not applicable	10.80 (274.3)	16 (7.26)	TC66664702	TC66664704	TC66700202	2HCLS-18R	
	450	24R	2	50	3.00 (76.2)	Not applicable	10.80 (274.3)	16 (7.26)	TC66664702	TC66664704	TC66700202	2HCLS-24R	

3.6

Current Limiting Fuses

ACLS, BCLS, CLS, HCLS and NCLS Type Fuses

CLS Type Current Limiting Fuses, continued

Maximum Design Voltage (kV)	Current Rating (Amperes)	"R" Designation	Barrel Number	Interrupting Rating rms (kA Sym.)	Clip Center		Length	Approximate Shipping Weight Lbs (kg)	Performance Curves		Peak Let-Through Current	Catalog Number
					Diameter	Approximate Dimensions in Inches (mm)			Minimum Melting Time	Total Clearing Time		
5.08	30	—	1	50	3.00 (76.2)	12.00 (304.8)	15.90 (403.9)	8 (3.63)	TC66690602	TC66690702	TC66700203	5CLS-30
	70	2R	1	50	3.00 (76.2)	12.00 (304.8)	15.90 (403.9)	8 (3.63)	TC66690602	TC66690702	TC66700203	5CLS-2R
	100	3R	1	50	3.00 (76.2)	12.00 (304.8)	15.90 (403.9)	8 (3.63)	TC66690602	TC66690702	TC66700203	5CLS-3R
	130	4R	1	50	3.00 (76.2)	12.00 (304.8)	15.90 (403.9)	8 (3.63)	TC66690602	TC66690702	TC66700203	5CLS-4R
	150	5R	1	50	3.00 (76.2)	12.00 (304.8)	15.90 (403.9)	8 (3.63)	TC66690602	TC66690702	TC66700203	5CLS-5R
	170	6R	1	50	3.00 (76.2)	12.00 (304.8)	15.90 (403.9)	8 (3.63)	TC66690602	TC66690702	TC66700203	5CLS-6R
	200	9R	1	50	3.00 (76.2)	12.00 (304.8)	15.90 (403.9)	8 (3.63)	TC66690602	TC66690702	TC66700203	5CLS-9R
	230	12R	1	50	3.00 (76.2)	12.00 (304.8)	15.90 (403.9)	8 (3.63)	TC66690602	TC66690702	TC66700203	5CLS-12R
	390	18R	2	50	3.00 (76.2)	12.00 (304.8)	15.90 (403.9)	17 (7.72)	TC66690602	TC66690702	TC66700203	5CLS-18R
	450	24R	2	50	3.00 (76.2)	12.00 (304.8)	15.90 (403.9)	17 (7.72)	TC66690602	TC66690702	TC66700203	5CLS-24R
5.08	30	—	1	50	3.00 (76.2)	Not applicable	15.90 (403.9)	8 (3.63)	TC66690602	TC66690702	TC66700203	5ACLS-30
	70	2R	1	50	3.00 (76.2)	Not applicable	15.90 (403.9)	8 (3.63)	TC66690602	TC66690702	TC66700203	5ACLS-2R
	100	3R	1	50	3.00 (76.2)	Not applicable	15.90 (403.9)	8 (3.63)	TC66690602	TC66690702	TC66700203	5ACLS-3R
	130	4R	1	50	3.00 (76.2)	Not applicable	15.90 (403.9)	8 (3.63)	TC66690602	TC66690702	TC66700203	5ACLS-4R
	150	5R	1	50	3.00 (76.2)	Not applicable	15.90 (403.9)	8 (3.63)	TC66690602	TC66690702	TC66700203	5ACLS-5R
	170	6R	1	50	3.00 (76.2)	Not applicable	15.90 (403.9)	8 (3.63)	TC66690602	TC66690702	TC66700203	5ACLS-6R
	200	9R	1	50	3.00 (76.2)	Not applicable	15.90 (403.9)	8 (3.63)	TC66690602	TC66690702	TC66700203	5ACLS-9R
	230	12R	1	50	3.00 (76.2)	Not applicable	15.90 (403.9)	8 (3.63)	TC66690602	TC66690702	TC66700203	5ACLS-12R
	390	18R	2	50	3.00 (76.2)	Not applicable	15.90 (403.9)	17 (7.72)	TC66690602	TC66690702	TC66700203	5ACLS-18R
	450	24R	2	50	3.00 (76.2)	Not applicable	15.90 (403.9)	17 (7.72)	TC66690602	TC66690702	TC66700203	5ACLS-24R
4.3	480	26R	2	50	3.00 (76.2)	Not applicable	15.90 (403.9)	17 (7.72)	TC66690602	TC66690702	TC66700203	4ACLS-26R
5.08	30	—	1	50	3.00 (76.2)	Not applicable	15.90 (403.9)	8 (3.63)	TC66690602	TC66690702	TC66700203	5BCLS-30
	70	2R	1	50	3.00 (76.2)	Not applicable	15.90 (403.9)	8 (3.63)	TC66690602	TC66690702	TC66700203	5BCLS-2R
	100	3R	1	50	3.00 (76.2)	Not applicable	15.90 (403.9)	8 (3.63)	TC66690602	TC66690702	TC66700203	5BCLS-3R
	130	4R	1	50	3.00 (76.2)	Not applicable	15.90 (403.9)	8 (3.63)	TC66690602	TC66690702	TC66700203	5BCLS-4R
	150	5R	1	50	3.00 (76.2)	Not applicable	15.90 (403.9)	8 (3.63)	TC66690602	TC66690702	TC66700203	5BCLS-5R
	170	6R	1	50	3.00 (76.2)	Not applicable	15.90 (403.9)	8 (3.63)	TC66690602	TC66690702	TC66700203	5BCLS-6R
	200	9R	1	50	3.00 (76.2)	Not applicable	15.90 (403.9)	8 (3.63)	TC66690602	TC66690702	TC66700203	5BCLS-9R
	230	12R	1	50	3.00 (76.2)	Not applicable	15.90 (403.9)	8 (3.63)	TC66690602	TC66690702	TC66700203	5BCLS-12R
	390	18R	2	50	3.00 (76.2)	Not applicable	15.90 (403.9)	17 (7.72)	TC66690602	TC66690702	TC66700203	5BCLS-18R
	450	24R	2	50	3.00 (76.2)	Not applicable	15.90 (403.9)	17 (7.72)	TC66690602	TC66690702	TC66700203	5BCLS-24R
4.3	480	26R	2	50	3.00 (76.2)	Not applicable	15.90 (403.9)	17 (7.72)	TC66690602	TC66690702	TC66700203	4BCLS-26R
5.08	30	—	1	50	3.00 (76.2)	Not applicable	15.90 (403.9)	8 (3.63)	TC66690602	TC66690702	TC66700203	5HCLS-30
	70	2R	1	50	3.00 (76.2)	Not applicable	15.90 (403.9)	8 (3.63)	TC66690602	TC66690702	TC66700203	5HCLS-2R
	100	3R	1	50	3.00 (76.2)	Not applicable	15.90 (403.9)	8 (3.63)	TC66690602	TC66690702	TC66700203	5HCLS-3R
	130	4R	1	50	3.00 (76.2)	Not applicable	15.90 (403.9)	8 (3.63)	TC66690602	TC66690702	TC66700203	5HCLS-4R
	150	5R	1	50	3.00 (76.2)	Not applicable	15.90 (403.9)	8 (3.63)	TC66690602	TC66690702	TC66700203	5HCLS-5R
	170	6R	1	50	3.00 (76.2)	Not applicable	15.90 (403.9)	8 (3.63)	TC66690602	TC66690702	TC66700203	5HCLS-6R
	200	9R	1	50	3.00 (76.2)	Not applicable	15.90 (403.9)	8 (3.63)	TC66690602	TC66690702	TC66700203	5HCLS-9R
	230	12R	1	50	3.00 (76.2)	Not applicable	15.90 (403.9)	8 (3.63)	TC66690602	TC66690702	TC66700203	5HCLS-12R
	390	18R	2	50	3.00 (76.2)	Not applicable	15.90 (403.9)	17 (7.72)	TC66690602	TC66690702	TC66700203	5HCLS-18R
	450	24R	2	50	3.00 (76.2)	Not applicable	15.90 (403.9)	17 (7.72)	TC66690602	TC66690702	TC66700203	5HCLS-24R

CLS Type Current Limiting Fuses, continued

Maximum Design Voltage (kV)	Current Rating (Amperes)	"R" Designation	Barrel Number	Interrupting Rating rms (kA Sym.)	Diameter	Clip Center	Length	Approximate Shipping Weight Lbs (kg)	Performance Curves		Peak Let-Through Current	Catalog Number
									Minimum Melting Time	Total Clearing Time		
5.08	70	2R	2	50	3.00 (76.2)	Not applicable	15.90 (403.9)	20 (9.08)	TC66690602	TC66690702	TC66700203	5CLS70-2R
	100	3R	2	50	3.00 (76.2)	Not applicable	15.90 (403.9)	20 (9.08)	TC66690602	TC66690702	TC66700203	5CLS70-3R
	130	4R	2	50	3.00 (76.2)	Not applicable	15.90 (403.9)	20 (9.08)	TC66690602	TC66690702	TC66700203	5CLS70-4R
	150	5R	2	50	3.00 (76.2)	Not applicable	15.90 (403.9)	20 (9.08)	TC66690602	TC66690702	TC66700203	5CLS70-5R
	170	6R	2	50	3.00 (76.2)	Not applicable	15.90 (403.9)	20 (9.08)	TC66690602	TC66690702	TC66700203	5CLS70-6R
	200	9R	2	50	3.00 (76.2)	Not applicable	15.90 (403.9)	20 (9.08)	TC66690602	TC66690702	TC66700203	5CLS70-9R
	230	12R	2	50	4.00 (101.6)	Not applicable	15.90 (403.9)	40 (18.16)	TC66690602	TC66690702	TC66700203	5CLS70-12R
	390	18R	2	50	4.00 (101.6)	Not applicable	15.90 (403.9)	40 (18.16)	TC66690602	TC66690702	TC66700203	5CLS70-18R
	450	24R	2	50	4.00 (101.6)	Not applicable	15.90 (403.9)	40 (18.16)	TC66690602	TC66690702	TC66700203	5CLS70-24R
	600	32R	2	50	4.00 (101.6)	Not applicable	15.90 (403.9)	40 (18.16)	TC66690602	TC66690702	TC66700203	5CLS70-32R
	650	36R	2	50	4.00 (101.6)	Not applicable	15.90 (403.9)	40 (18.16)	TC66690602	TC66690702	TC66700203	5CLS70-36R
	700	44R	2	50	4.00 (101.6)	Not applicable	15.90 (403.9)	40 (18.16)	TC66690602	TC66690702	TC66700203	5CLS70-44R
5.5	70	2R	1	50	3.00 (76.2)	14.00 (355.6)	17.90 (454.7)	11 (4.99)	TC51285302	TC51285402	TC66700204	5LCLS-2R
	100	3R	1	50	3.00 (76.2)	14.00 (355.6)	17.90 (454.7)	11 (4.99)	TC51285302	TC51285402	TC66700204	5LCLS-3R
	130	4R	1	50	3.00 (76.2)	14.00 (355.6)	17.90 (454.7)	11 (4.99)	TC51285302	TC51285402	TC66700204	5LCLS-4R
	150	5R	1	50	3.00 (76.2)	14.00 (355.6)	17.90 (454.7)	11 (4.99)	TC51285302	TC51285402	TC66700204	5LCLS-5R
	170	6R	1	50	3.00 (76.2)	14.00 (355.6)	17.90 (454.7)	11 (4.99)	TC51285302	TC51285402	TC66700204	5LCLS-6R
	200	9R	1	50	3.00 (76.2)	14.00 (355.6)	17.90 (454.7)	11 (4.99)	TC51285302	TC51285402	TC66700204	5LCLS-9R
	230	12R	1	50	3.00 (76.2)	14.00 (355.6)	17.90 (454.7)	11 (4.99)	TC51285302	TC51285402	TC66700204	5LCLS-12R
	390	18R	2	50	3.00 (76.2)	14.00 (355.6)	17.90 (454.7)	22 (9.99)	TC51285302	TC51285402	TC66700204	5LCLS-18R
	450	24R	2	50	3.00 (76.2)	14.00 (355.6)	17.90 (454.7)	22 (9.99)	TC51285302	TC51285402	TC66700204	5LCLS-24R
	8.3	70	2R	1	50	3.00 (76.2)	12.00 (304.8)	15.90 (403.9)	7 (3.18)	TC66700602	TC66700702	TC66700205
100		3R	1	50	3.00 (76.2)	12.00 (304.8)	15.90 (403.9)	7 (3.18)	TC66700602	TC66700702	TC66700205	8CLS-3R
130		4R	1	50	3.00 (76.2)	12.00 (304.8)	15.90 (403.9)	7 (3.18)	TC66700602	TC66700702	TC66700205	8CLS-4R
150		5R	1	50	3.00 (76.2)	12.00 (304.8)	15.90 (403.9)	7 (3.18)	TC66700602	TC66700702	TC66700205	8CLS-5R
170		6R	1	50	3.00 (76.2)	12.00 (304.8)	15.90 (403.9)	7 (3.18)	TC66700602	TC66700702	TC66700205	8CLS-6R
7.2	200	9R	1	50	3.00 (76.2)	12.00 (304.8)	15.90 (403.9)	7 (3.18)	TC66700602	TC66700702	TC66700205	7CLS-9R
	230	12R	1	50	3.00 (76.2)	12.00 (304.8)	15.90 (403.9)	7 (3.18)	TC66700602	TC66700702	TC66700205	7CLS-12R
	390	18R	2	50	3.00 (76.2)	12.00 (304.8)	15.90 (403.9)	16 (7.26)	TC66700602	TC66700702	TC66700205	7CLS-18R
	450	24R	2	50	3.00 (76.2)	12.00 (304.8)	15.90 (403.9)	16 (7.26)	TC66700602	TC66700702	TC66700205	7CLS-24R
8.3	70	2R	1	50	3.00 (76.2)	Not applicable	15.90 (403.9)	7 (3.18)	TC66700602	TC66700702	TC66740205	7BCLS-2R
	100	3R	1	50	3.00 (76.2)	Not applicable	15.90 (403.9)	7 (3.18)	TC66700602	TC66700702	TC66740205	7BCLS-3R
	130	4R	1	50	3.00 (76.2)	Not applicable	15.90 (403.9)	7 (3.18)	TC66700602	TC66700702	TC66740205	7BCLS-4R
	150	5R	1	50	3.00 (76.2)	Not applicable	15.90 (403.9)	7 (3.18)	TC66700602	TC66700702	TC66740205	7BCLS-5R
	170	6R	1	50	3.00 (76.2)	Not applicable	15.90 (403.9)	7 (3.18)	TC66700602	TC66700702	TC66740205	7BCLS-6R
7.2	200	9R	1	50	3.00 (76.2)	Not applicable	15.90 (403.9)	7 (3.18)	TC66700602	TC66700702	TC66740205	7BCLS-9R
	230	12R	1	50	3.00 (76.2)	Not applicable	15.90 (403.9)	7 (3.18)	TC66700602	TC66700702	TC66740205	7BCLS-12R
	390	18R	2	50	3.00 (76.2)	Not applicable	15.90 (403.9)	16 (7.26)	TC66700602	TC66700702	TC66740205	7BCLS-18R
	450	24R	2	50	3.00 (76.2)	Not applicable	15.90 (403.9)	16 (7.26)	TC66700602	TC66700702	TC66740205	7BCLS-24R
8.3	70	2R	1	50	3.00 (76.2)	Not applicable	15.90 (403.9)	8 (3.63)	TC66700602	TC66700702	TC66740205	8ACLS-2R
	100	3R	1	50	3.00 (76.2)	Not applicable	15.90 (403.9)	8 (3.63)	TC66700602	TC66700702	TC66740205	8ACLS-3R
	130	4R	1	50	3.00 (76.2)	Not applicable	15.90 (403.9)	8 (3.63)	TC66700602	TC66700702	TC66740205	8ACLS-4R
	150	5R	1	50	3.00 (76.2)	Not applicable	15.90 (403.9)	8 (3.63)	TC66700602	TC66700702	TC66740205	8ACLS-5R
	170	6R	1	50	3.00 (76.2)	Not applicable	15.90 (403.9)	8 (3.63)	TC66700602	TC66700702	TC66740205	8ACLS-6R

3.6

Current Limiting Fuses

ACLS, BCLS, CLS, HCLS and NCLS Type Fuses

CLS Type Current Limiting Fuses, continued

Maximum Design Voltage (kV)	Current Rating (Amperes)	"R" Designation	Barrel Number	Interrupting Rating rms (kA Sym.)	Clip Center		Length	Approximate Shipping Weight Lbs (kg)	Performance Curves		Peak Let-Through Current	Catalog Number
					Diameter	Center			Minimum Melting Time	Total Clearing Time		
					Approximate Dimensions in Inches (mm)							
7.2	200	9R	1	50	3.00 (76.2)	Not applicable	15.90 (403.9)	8 (3.63)	TC66700602	TC66700702	TC66740205	7ACLS-9R
	230	12R	1	50	3.00 (76.2)	Not applicable	15.90 (403.9)	8 (3.63)	TC66700602	TC66700702	TC66740205	7ACLS-12R
	390	18R	2	50	3.00 (76.2)	Not applicable	15.90 (403.9)	17 (7.72)	TC66700602	TC66700702	TC66740205	7ACLS-18R
	450	24R	2	50	3.00 (76.2)	Not applicable	15.90 (403.9)	17 (7.72)	TC66700602	TC66700702	TC66740205	7ACLS-24R
	450	24R	2	50	3.00 (76.2)	Not applicable	15.90 (403.9)	20 (9.08)	TC66700602	TC66700702	TC66740205	7CLS70-24R
	650	36R	3	50	3.00 (76.2)	Not applicable	15.90 (403.9)	30 (13.62)	TC66700602	TC66700702	TC66740205	7CLS70-36R
	700	44R	2	50	4.00 (101.6)	Not applicable	15.90 (403.9)	40 (18.16)	TC66700602	TC66700702	TC66740205	7CLS70-44R
8.3	15	Not applicable	1	50	3.00 (76.2)	14.00 (355.6)	17.90 (454.7)	11 (4.99)	TC66664202	TC66664302	TC66679802	8CLS-15
	30	Not applicable	1	50	3.00 (76.2)	14.00 (355.6)	17.90 (454.7)	11 (4.99)	TC66664202	TC66664302	TC66679802	8CLS-30
	60	Not applicable	1	50	3.00 (76.2)	14.00 (355.6)	17.90 (454.7)	11 (4.99)	TC66664202	TC66664302	TC66679802	8CLS-60
	70	Not applicable	1	50	3.00 (76.2)	14.00 (355.6)	17.90 (454.7)	11 (4.99)	TC66664202	TC66664302	TC66679802	8CLS-70
	90	Not applicable	1	50	3.00 (76.2)	14.00 (355.6)	17.90 (454.7)	11 (4.99)	TC66664202	TC66664302	TC66679802	8CLS-90
	110	Not applicable	1	50	3.00 (76.2)	14.00 (355.6)	17.90 (454.7)	11 (4.99)	TC66664202	TC66664302	TC66679802	8CLS-110
	125	Not applicable	1	50	3.00 (76.2)	14.00 (355.6)	17.90 (454.7)	11 (4.99)	TC66664202	TC66664302	TC66679802	8CLS-125
	150	Not applicable	2	50	3.00 (76.2)	14.00 (355.6)	17.90 (454.7)	22 (9.99)	TC66664202	TC66664302	TC66679802	8CLS-150
	200	Not applicable	2	50	3.00 (76.2)	14.00 (355.6)	17.90 (454.7)	22 (9.99)	TC66664202	TC66664302	TC66679802	8CLS-200
	225	Not applicable	2	50	3.00 (76.2)	14.00 (355.6)	17.90 (454.7)	22 (9.99)	TC66664202	TC66664302	TC66679802	8CLS-225

Dimensions

Approximate Dimensions in Inches (mm)

CLS Type Fuse

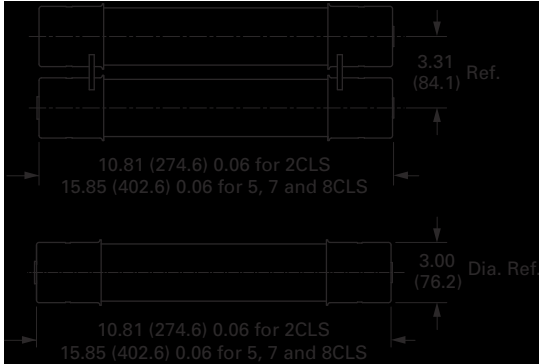

5BCLS and 7BCLS Type Fuses

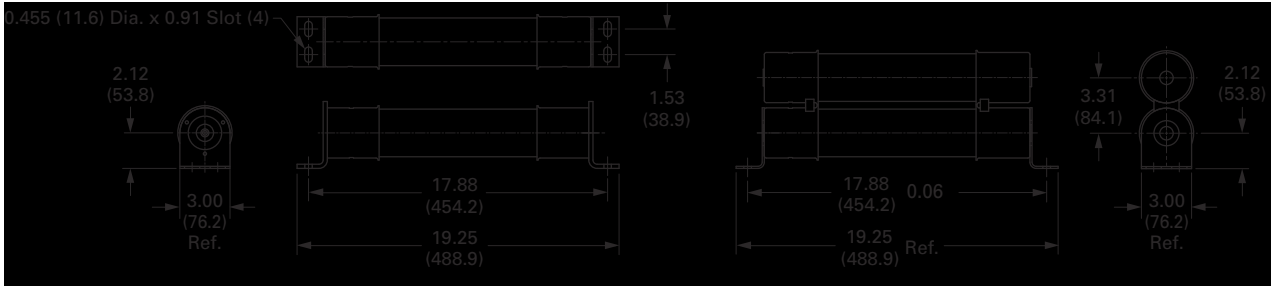

2BCLS Type Fuse

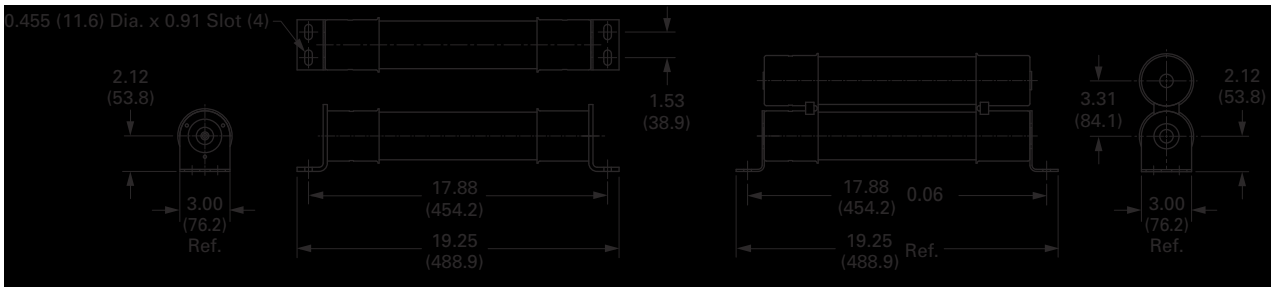

3.6

Current Limiting Fuses

ACLS, BCLS, CLS, HCLS and NCLS Type Fuses

CLS Type Mountings and Hardware

Maximum Design Voltage (kV)	Ampere Rating	Fuse Mounting Type	Voltage BIL (kV)	Mounting (Including Live Parts, End Fittings) ①		Live Parts (Including End Fittings)	End Fittings (Disconnect Only)
				Porcelain Insulator	Glass-Polyester Insulator	Catalog Number	Catalog Number
				Catalog Number	Catalog Number		
2.54	25–230	Non-disconnect	60	2CLE-PNM-D	2CLE-GNM-D	CLE-NL-D	—
		Disconnect	60	2CLE-PDM-D	2CLE-GDM-E	CLE-DL-D	CLE-DF-D
	390–450	Non-disconnect	60	2CLE-PNM-E	2CLE-GNM-E	CLE-NL-E	—
		Disconnect	60	2CLE-PDM-E	2CLE-GDM-E	CLE-DL-E	CLE-DF-E
5.5 (CLS)	30–230	Non-disconnect	60	5HLE-PNM-D	5HLE-GNM-D	CLE-NL-D	—
		Disconnect	60	5HLE-PDM-D	5HLE-GDM-E	CLE-DL-D	CLE-DF-D
	390–480	Non-disconnect	60	5HLE-PNM-E	5HLE-GNM-E	CLE-NL-E	—
		Disconnect	60	5HLE-PDM-E	5HLE-GDM-E	CLE-DL-E	CLE-DF-E
5.5 (LCLS)	70–230	Non-disconnect	60	5CLE-PNM-D	5CLE-GNM-D	CLE-NL-D	—
		Disconnect	60	5CLE-PDM-D	5CLE-GDM-D	CLE-DL-D	CLE-DF-D
			75	8CLE-PDM-D	8CLE-GDM-D	CLE-DL-D	CLE-DF-D
	390–450	Non-disconnect	60	5CLE-PNM-E	5CLE-GNM-E	CLE-NL-E	—
		Disconnect	60	5CLE-PDM-E	5CLE-GDM-E	CLE-DL-E	CLE-DF-E
			75	8CLE-PDM-E	8CLE-PDM-E	CLE-DL-E	CLE-DF-E
8.3	70–100	Non-disconnect	75	8HLE-PNM-D	8HLE-GNM-D	CLE-NL-D	—
	130–230	Disconnect	75	8HLE-PDM-D	8HLE-GDM-D	CLE-DL-D	CLE-DF-D
7.2	390–450	Non-disconnect	75	8HLE-PDM-E	8HLE-GNM-E	CLE-NL-E	—
		Disconnect	75	8HLE-PDM-E	8HLE-GDM-E	CLE-DL-E	CLE-DF-E
8.3	15–30	Non-disconnect	75	8CLE-PNM-D	8CLE-GNM-D	CLE-NL-D	—
	60–125	Disconnect	75	8CLE-PDM-D	8CLE-GDM-D	CLE-DL-D	CLS-DF-D
	150–225	Non-disconnect	75	8CLE-PNM-E	8CLE-GNM-E	CLE-NL-E	—
Disconnect		75	8CLE-PDM-E	8CLE-GDM-E	CLE-DL-E	CLE-DF-E	

Note

① Disconnect only.

CLT Fuse



CLT Type Fuses

Applications

Eaton's CLT fuses are designed specifically to provide fault protection on high capacity indoor and underground distribution systems. These general purpose current limiting fuses meet or exceed C37 standards for this class of distribution fuse. CLT fuses may be used in conjunction with EFD load break switches that meet the full switching requirements of underground distribution systems using pad-mounted transformers. In addition, CLT fuses may be applied in pad-mounted transformer drawout wells or in conjunction with LBOR oil switches as a means of low-cost transformer protection.

Fuse Ratings Available

Voltage (kV)	Amperes
2.75	5–150
5.5	8–60
8.3	5–45
14.4	30
15.5	4–18

CLT Features

CLT type current limiting fuses offer a number of desirable advantages. Consider the following during the selection process:

- Quiet Safe Operation:** CLT fuses are non-indicating and will clear all currents from minimum melting to maximum interrupting rating without any external disturbance or expulsion of gas
- Limits Fault Current Let-Through:** The let-through current for a high short-circuit fault is limited to a value far below the available peak current because the current is forced to zero before the end of the first half cycle
- Arc-Voltage Protection:** CLT fuses control the arc voltage that is produced during current limitation to less than three times the normal operating voltage rating
- Maintains Non-Conductance After Interruption:** Specially designed cores prevent internal flash through when rated voltage remains across the fuse after interruption

Contents

Description

Description	Page
CLT Type Fuses	
Product Selection	V14-T3-66
Dimensions	V14-T3-66

- Low-Cost Transformer Protection:** The CLT fuse can be used in EFD load break switches and dry well drawout holders

Construction and Operation

CLT fuses are constructed with pure silver fuse elements, high purity silica sand fill with controlled grain size, a specially designed core, and a glass-epoxy outer casing.

During a high fault current, the silver element(s) melts almost instantly losing energy to the surrounding sand. The energy melts the sand forming a glass-like substance commonly referred to as "fulgurite." The arc voltage rapidly increases to about three times the fuse voltage rating, forcing the current to zero. The fault current is interrupted in one-half cycle or less without noise or expulsion of gases.

Current limiting action occurs only when the current is above the threshold current for the fuse, that is, the current is high enough to melt the fuse element(s) before the peak value of current is reached in the first half cycle.

Low level currents are cleared by the melting of a tin solder drop on the fuse element that in turn causes the silver element to melt. This is called the M-effect. The silver element then burns back until there is sufficient internal gap to interrupt the current.

Ratings and Selection

When a decision has been made to use current limiting fuses, the minimum amount of information required to make the proper selection is:

- Voltage rating
- Current rating
- Interrupting rating
- Mounting method

See the table on **Page V14-T3-66** for assistance in selecting the correct fuse catalog number.

These types of fuses are designed specifically to provide fault protection on high capacity indoor and underground distribution systems.

3.7

Current Limiting Fuses

CLT Type Fuses

Product Selection

CLT Type Current Limiting Fuses

3

Maximum Design Voltage (kV)	Current Rating (Amperes)	Catalog Number	Barrel Number	Interrupting Rating rms (kA Sym.)	Approx. Diameter in (mm)	Length (Inches)	Approx. Shipping Weight (Lbs)	Performance Curves		
								Minimum Melting Time	Total Clearing Time	Peak Let-Through Current
2.75	5	2CLT-5	1	25	1.60 (40.6)	9.70 (246.4)	1.25	TC59885801	TC66675901	TC62909001
	12	2CLT-12	1	25	1.60 (40.6)	9.70 (246.4)	1.25			
	18	2CLT-18	1	25	1.60 (40.6)	9.70 (246.4)	1.25			
	25	2CLT-25	1	25	1.60 (40.6)	9.70 (246.4)	1.25			
	30	2CLT-30	1	25	1.60 (40.6)	9.70 (246.4)	1.25			
	75	2CLT-75	1	25	1.60 (40.6)	9.70 (246.4)	1.25			
	90	2CLT-90	1	25	2.25 (57.1)	9.76 (248.0)	2.5			
	150	2CLT-150	1	25	2.25 (57.1)	9.76 (248.0)	2.5			
5.5	8	5CLT-8	1	25	1.60 (40.6)	9.70 (246.4)	1.25	TC59885803	TC66675903	TC62909002
	12	5CLT-12	1	25	1.60 (40.6)	9.70 (246.4)	1.25			
	18	5CLT-18	1	25	1.60 (40.6)	9.70 (246.4)	1.25			
	25	5CLT-25	1	25	1.60 (40.6)	9.70 (246.4)	1.25			
	30	5CLT-30	1	25	2.25 (57.1)	9.76 (248.0)	2.5			
	45	5CLT-45	1	25	2.25 (57.1)	9.76 (248.0)	2.5			
8.3	5	8CLT-5	1	25	1.60 (40.6)	9.70 (246.4)	1.25	TC59885805	TC66675905	TC62909003
	8	8CLT-8	1	25	1.60 (40.6)	9.70 (246.4)	1.25			
	12	8CLT-12	1	25	1.60 (40.6)	9.70 (246.4)	1.25			
	18	8CLT-18	1	25	1.60 (40.6)	9.70 (246.4)	1.25			
	25	8CLT-25	1	25	1.60 (40.6)	9.70 (246.4)	1.25			
	30	8CLT-30	1	25	1.60 (40.6)	11.00 (279.4)	1.25			
	30	8CLT-30	1	25	2.25 (57.1)	9.76 (248.0)	2.5			
	45	8CLT-45	1	25	2.25 (57.1)	9.76 (248.0)	2.5			
15.5	4	15CLT-4	1	25	2.25 (57.1)	9.76 (248.0)	2.5	TC59885701	TC66676001	TC63942701
	5	15CLT-5	1	25	2.25 (57.1)	9.76 (248.0)	2.5			
	8	15CLT-8	1	25	2.25 (57.1)	9.76 (248.0)	2.5			
	12	15CLT-12	1	25	2.25 (57.1)	9.76 (248.0)	2.5			
	18	15CLT-18	1	25	2.25 (57.1)	9.76 (248.0)	2.5			
14.4	30	15CLT-30	1	25	2.25 (57.1)	9.76 (248.0)	2.5	TC59885701	TC66676001	TC63942701

Dimensions

Approximate Dimensions in Inches (mm).

The drawing below specifies certain dimensions and references other dimensions. Refer to the table above for the referenced dimensions of particular CLT type fuses.

CLT Type Fuse

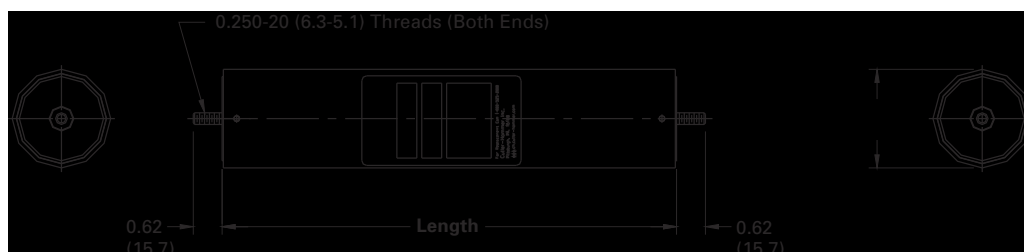

Eaton CX Fuses



CX, CXI and CXN Type Fuses

Applications

Eaton's CX, CXI and CXN general purpose current limiting fuses are designed specifically to provide complete fault protection on high capacity indoor and underground distribution systems. These fuses are C-rated and exceed the requirements of C37 standards for general purpose distribution current limiting fuses.

- Pad-mounted and submersible three-phase and single-phase transformers
- Pad-mounted and submersible switch and fuse units
- Station service protection
- Primary switch and fuse units on mine rectifiers

Note: CXI fuses are not suitable for submersible applications.

CXN fuses are applied in:

- Power transformer protection
- Power centers
- Load interrupters
- Feeder circuit protection
- Mine rectifiers

CX, CXI and CXN Features

CX and CXN type current limiting fuses offer a number of desirable advantages. Consider the following during the selection process:

- **Quiet Safe Operation:** CX and CXN fuses are non-indicating devices—CXI fuses are indicating devices. These fuses will clear all currents from their minimum melting current to their maximum interrupting rating without any external disturbance or expulsion of gas
- **Limits Fault Current Let-Through:** The let-through current for a high short-circuit fault is limited to a value far below the available peak current because the current is forced to zero before the end of the first half cycle
- **Arc-Voltage Protection:** CX and CXN fuses control the arc voltage that is produced during current limitation to less than three times the normal operating voltage rating

Contents

Description

CX, CXI and CXN Type Fuses

	<i>Page</i>
CXN Construction	V14-T3-68
CXN Ratings	V14-T3-68
CX Construction and Operation	V14-T3-68
Product Selection	V14-T3-69
Dimensions	V14-T3-75

- **Maintains Non-Conductance After Interruption:** An inorganic core with spaced arc guards prevent internal flash through when rated voltage remains across the fuse after interruption
- **Fits Many Mountings:** CX and CXN fuses can be used in disconnect and non-disconnect mountings. CX fuses can be used in EFD load break switches through 8.3 kV and dry well drawout fuse holders
- **Interchangeable:** CX and CXI fuses are a direct replacement for competitive general purpose distribution class current limiting fuses

CXN Construction

CXN type fuses are constructed with pure silver fuse elements, high purity silica sand filler with controlled grain size, an inorganic core with spaced arc suppressors, and a glass melamine or glass epoxy outer casing.

The end studs of CXN fuses are identical to the CX type. However, CXN fuses have a much higher C-rating, are longer in physical length and larger in diameter. The diameters are 3 or 4 inches depending on the ratings.

CXN Ratings

The C-rating range is from 60C to 300C at 8.3 kV, with some ratings including 300C being achieved by paralleling two (2) 150C single barrel fuses.

At 15 kV, the ranges are 45C to 175C, with 120C, 150C and 175C being achieved by paralleling single barrel fuses.

The tested and approved parallel ratings are specified in the product selection tables.

CX Construction and Operation

CX and CXI type fuses are constructed with pure silver fuse elements, high purity silica sand filler with controlled grain size, an inorganic core with spaced arc suppressors, and a glass melamine or glass epoxy outer casing.

During a high fault current, the silver element(s) melts almost instantly losing energy to the surrounding sand. The energy melts the sand forming a glass-like substance commonly referred to as "fulgurite." The arc voltage rapidly increases to about three times the fuse voltage rating, forcing the current to zero. The fault current is interrupted in one-half cycle or less without noise or expulsion of gases.

Current limiting action occurs only when the current is above the threshold current for the fuse, that is, the current is high enough to melt the fuse elements) before the peak value of current is reached in the first half cycle.

Low level currents are cleared by the melting of a tin solder drop on the fuse element that in turn causes the silver element to melt. This is called the M-effect. The silver element then burns back until there is sufficient internal gap to interrupt the current.

In some instances where the required C-rating exceeds the limits of CX fuses, it is possible to move the live parts to accommodate the longer CXN fuse, and where space and clearances present no problem, the larger CXN fuse can be substituted for a CX fuse.

Product Selection

CX Type

CX Type



CX Type Current Limiting Fuses 4.3 kV Maximum (2.4 kV Nominal)

Current Rating (Amperes)	Barrel Number	Interrupting Rating rms (kA Sym.)	Fuse Mounting Code	Diameter Approximate Dimensions in Inches (mm)	Length	Approximate Shipping Weight Lbs (kg)	Performance Curves				Catalog Number
							Minimum Melting Time	Total Clearing Time	Peak Let-Through Current	I^2t	
Non-Indicating											
18C	1	50	G	1.13 (28.7)	10.00 (254.0)	1 (0.45)	TC70544101	TC70544501	TC70544901	TC70545101	4CX-18C
25C	1	50	G	1.13 (28.7)	10.00 (254.0)	1 (0.45)	TC70544101	TC70544501	TC70544901	TC70545101	4CX-25C
35C	1	50	G	2.00 (50.8)	10.00 (254.0)	1 (0.45)	TC70544101	TC70544501	TC70544901	TC70545101	4CX-35C
45C	1	50	G	2.00 (50.8)	10.00 (254.0)	2 (0.91)	TC70544101	TC70544501	TC70544901	TC70545101	4CX-45C
50C	1	50	G	2.00 (50.8)	10.00 (254.0)	2 (0.91)	TC70544101	TC70544501	TC70544901	TC70545101	4CX-50C
60C	1	50	G	2.00 (50.8)	10.00 (254.0)	2 (0.91)	TC70544102	TC70544502	TC70544901	TC70545101	4CX-60C
65C	1	50	G	2.00 (50.8)	10.00 (254.0)	2 (0.91)	TC70544102	TC70544501	TC70544901	TC70545101	4CX-65C
75C	1	50	G	2.00 (50.8)	10.00 (254.0)	2 (0.91)	TC70544102	TC70544501	TC70544901	TC70545101	4CX-75C
80C	1	50	G	2.00 (50.8)	10.00 (254.0)	2 (0.91)	TC70544102	TC70544502	TC70544901	TC70545101	4CX-80C
100C	1	50	G	2.00 (50.8)	10.00 (254.0)	2 (0.91)	TC70544102	TC70544501	TC70544901	TC70545101	4CX-100C
Indicating											
18C	1	50	G	1.13 (28.7)	10.00 (254.0)	1 (0.45)	TC70544101	TC70544501	TC70544901	TC70545101	4CXI-18C
25C	1	50	G	1.13 (28.7)	10.00 (254.0)	1 (0.45)	TC70544101	TC70544501	TC70544901	TC70545101	4CXI-25C
35C	1	50	G	2.00 (50.8)	10.00 (254.0)	1 (0.45)	TC70544101	TC70544501	TC70544901	TC70545101	4CXI-35C
45C	1	50	G	2.00 (50.8)	10.00 (254.0)	2 (0.91)	TC70544101	TC70544501	TC70544901	TC70545101	4CXI-45C
50C	1	50	G	2.00 (50.8)	10.00 (254.0)	2 (0.91)	TC70544101	TC70544501	TC70544901	TC70545101	4CXI-50C
60C	1	50	G	2.00 (50.8)	10.00 (254.0)	2 (0.91)	TC70544102	TC70544502	TC70544901	TC70545101	4CXI-60C
65C	1	50	G	2.00 (50.8)	10.00 (254.0)	2 (0.91)	TC70544102	TC70544501	TC70544901	TC70545101	4CXI-65C
75C	1	50	G	2.00 (50.8)	10.00 (254.0)	2 (0.91)	TC70544102	TC70544501	TC70544901	TC70545101	4CXI-75C
80C	1	50	G	2.00 (50.8)	10.00 (254.0)	2 (0.91)	TC70544102	TC70544502	TC70544901	TC70545101	4CXI-80C
100C	1	50	G	2.00 (50.8)	10.00 (254.0)	2 (0.91)	TC70544102	TC70544501	TC70544901	TC70545101	4CXI-100C

CX Type Mountings and Hardware 4.3 kV Maximum (2.4 kV Nominal)

Ampere Rating	Fuse Mounting Type ^①	Size	Voltage BIL (kV)	Mounting (Including Live Parts, End Fittings) ^②		Live Parts (Including End Fittings) ^②	End Fittings (Disconnect Only)
				Porcelain Insulator Catalog Number	Glass-Polyester Insulator Catalog Number		
18C–100C	Non-disconnect	A	60	—	5CX-GNM-G	CX-NL	—
	Disconnect	A	60	—	5CX-GDM-G	CX-DL	CX-DF

Notes

- ^① See Page V14-T3-38 for diagram of typical mounting.
- ^② End fittings supplied only when required.

CX Type



3

CX Type Current Limiting Fuses 5.5 kV Maximum (4.8 kV Nominal)

Current Rating (Amperes)	Barrel Number	Interrupting Rating rms (kA Sym.)	Fuse Mounting Code	Diameter	Length	Approximate Shipping Weight Lbs (kg)	Performance Curves			Catalog Number	
				Approximate Dimensions in Inches (mm)	Minimum Melting Time		Total Clearing Time	Peak Let-Through Current	I^2t		
Non-Indicating											
10C	1	50	G	1.13 (28.7)	10.00 (254.0)	1 (0.45)	TC70544201	TC70544601	TC70544902	TC70545201	5CX-10C
12C	1	50	G	1.13 (28.7)	10.00 (254.0)	1 (0.45)	TC70544201	TC70544601	TC70544902	TC70545201	5CX-12C
18C	1	50	G	1.13 (28.7)	10.00 (254.0)	1 (0.45)	TC70544201	TC70544601	TC70544902	TC70545201	5CX-18C
20C	1	50	G	1.13 (28.7)	10.00 (254.0)	1 (0.45)	TC70544201	TC70544601	TC70544902	TC70545201	5CX-20C
21C	1	50	G	2.00 (50.8)	10.00 (254.0)	2 (0.91)	TC70544202	TC70544602	TC70544902	TC70545201	5CX-21C
25C	1	50	G	2.00 (50.8)	10.00 (254.0)	2 (0.91)	TC70544201	TC70544601	TC70544902	TC70545201	5CX-25C
30C	1	50	G	1.13 (28.7)	10.00 (254.0)	1 (0.45)	TC70544201	TC70544601	TC70544902	TC70545201	5CX-30C
35C	1	50	G	2.00 (50.8)	10.00 (254.0)	2 (0.91)	TC70544202	TC70544602	TC70544902	TC70545201	5CX-35C
40C	1	50	G	2.00 (50.8)	10.00 (254.0)	2 (0.91)	TC70544201	TC70544601	TC70544902	TC70545201	5CX-40C
50C	1	50	G	2.00 (50.8)	10.00 (254.0)	2 (0.91)	TC70544201	TC70544601	TC70544902	TC70545201	5CX-50C
60C	1	50	G	2.00 (50.8)	10.00 (254.0)	2 (0.91)	TC70544202	TC70544602	TC70544902	TC70545201	5CX-60C
65C	1	50	G	2.00 (50.8)	10.00 (254.0)	2 (0.91)	TC70544201	TC70544601	TC70544902	TC70545201	5CX-65C
75C	1	50	G	2.00 (50.8)	10.00 (254.0)	2 (0.91)	TC70544201	TC70544601	TC70544902	TC70545201	5CX-75C
Indicating											
10C	1	50	G	1.13 (28.7)	10.00 (254.0)	1 (0.45)	TC70544201	TC70544601	TC70544902	TC70545201	5CXI-10C
12C	1	50	G	1.13 (28.7)	10.00 (254.0)	1 (0.45)	TC70544201	TC70544601	TC70544902	TC70545201	5CXI-12C
18C	1	50	G	1.13 (28.7)	10.00 (254.0)	1 (0.45)	TC70544201	TC70544601	TC70544902	TC70545201	5CXI-18C
20C	1	50	G	1.13 (28.7)	10.00 (254.0)	1 (0.45)	TC70544201	TC70544601	TC70544902	TC70545201	5CXI-20C
21C	1	50	G	2.00 (50.8)	10.00 (254.0)	2 (0.91)	TC70544202	TC70544602	TC70544902	TC70545201	5CXI-21C
25C	1	50	G	2.00 (50.8)	10.00 (254.0)	2 (0.91)	TC70544201	TC70544601	TC70544902	TC70545201	5CXI-25C
30C	1	50	G	1.13 (28.7)	10.00 (254.0)	1 (0.45)	TC70544201	TC70544601	TC70544902	TC70545201	5CXI-30C
35C	1	50	G	2.00 (50.8)	10.00 (254.0)	2 (0.91)	TC70544202	TC70544602	TC70544902	TC70545201	5CXI-35C
40C	1	50	G	2.00 (50.8)	10.00 (254.0)	2 (0.91)	TC70544201	TC70544601	TC70544902	TC70545201	5CXI-40C
50C	1	50	G	2.00 (50.8)	10.00 (254.0)	2 (0.91)	TC70544201	TC70544601	TC70544902	TC70545201	5CXI-50C
60C	1	50	G	2.00 (50.8)	10.00 (254.0)	2 (0.91)	TC70544202	TC70544602	TC70544902	TC70545201	5CXI-60C
65C	1	50	G	2.00 (50.8)	10.00 (254.0)	2 (0.91)	TC70544201	TC70544601	TC70544902	TC70545201	5CXI-65C
75C	1	50	G	2.00 (50.8)	10.00 (254.0)	2 (0.91)	TC70544201	TC70544601	TC70544902	TC70545201	5CXI-75C

CX Type Mountings and Hardware 5.5 kV Maximum (4.8 kV Nominal)

Ampere Rating	Fuse Mounting Type ^①	Size	Voltage BIL (kV)	Mounting (Including Live Parts, End Fittings) ^②		Live Parts (Including End Fittings) ^②	End Fittings (Disconnect Only)
				Porcelain Insulator Catalog Number	Glass-Polyester Insulator Catalog Number	Catalog Number	Catalog Number
10C-75C	Non-disconnect	A	60	—	5CX-GNM-G	CX-NL	—
	Disconnect	A	60	—	5CX-GDM-G	CX-DL	CX-DF

Notes

- ① See Page V14-T3-38 for diagram of typical mounting.
- ② End fittings supplied only when required.

CX Type



CX Type Current Limiting Fuses 8.3 kV Maximum (7.2 kV Nominal)

Current Rating (Amperes)	Barrel Number	Interrupting Rating rms (kA Sym.)	Fuse Mounting Code	Diameter	Length	Approximate Shipping Weight Lbs (kg)	Performance Curves			Catalog Number	
				Approximate Dimensions in Inches (mm)	Approximate Dimensions in Inches (mm)		Minimum Melting Time	Total Clearing Time	Peak Let-Through Current		I^2t
Non-Indicating											
3.5C	1	50	G	1.13 (28.7)	10.00 (254.0)	2 (0.91)	TC70544302	TC70544702	TC70545001	TC70545301	8CX-3.5C
4C	1	50	G	1.13 (28.7)	10.00 (254.0)	2 (0.91)	TC70544302	TC70544702	TC70545001	TC70545301	8CX-4C
4.5C	1	50	G	1.13 (28.7)	10.00 (254.0)	2 (0.91)	TC70544301	TC70544701	TC70545001	TC70545301	8CX-4.5C
6C	1	50	G	1.13 (28.7)	10.00 (254.0)	2 (0.91)	TC70544301	TC70544701	TC70545001	TC70545301	8CX-6C
7C	1	50	G	1.13 (28.7)	10.00 (254.0)	2 (0.91)	TC70544302	TC70544702	TC70545001	TC70545301	8CX-7C
8C	1	50	G	1.13 (28.7)	10.00 (254.0)	2 (0.91)	TC70544301	TC70544701	TC70545001	TC70545301	8CX-8C
10C	1	50	G	1.13 (28.7)	10.00 (254.0)	2 (0.91)	TC70544301	TC70544701	TC70545001	TC70545301	8CX-10C
12C	1	50	G	1.13 (28.7)	10.00 (254.0)	2 (0.91)	TC70544301	TC70544701	TC70545001	TC70545301	8CX-12C
15C	1	50	G	1.13 (28.7)	10.00 (254.0)	2 (0.91)	TC70544302	TC70544702	TC70545001	TC70545301	8CX-15C
18C	1	50	G	2.00 (50.8)	10.00 (254.0)	2 (0.91)	TC70544301	TC70544701	TC70545001	TC70545301	8CX-18C
20C	1	50	G	2.00 (50.8)	10.00 (254.0)	2 (0.91)	TC70544301	TC70544701	TC70545001	TC70545301	8CX-20C
25C	1	50	G	2.00 (50.8)	10.00 (254.0)	2 (0.91)	TC70544301	TC70544701	TC70545001	TC70545301	8CX-25C
30C	1	50	G	2.00 (50.8)	10.00 (254.0)	2 (0.91)	TC70544301	TC70544701	TC70545001	TC70545301	8CX-30C
35C	1	50	G	2.00 (50.8)	10.00 (254.0)	2 (0.91)	TC70544302	TC70544702	TC70545001	TC70545301	8CX-35C
40C	1	50	G	2.00 (50.8)	10.00 (254.0)	2 (0.91)	TC70544301	TC70544701	TC70545001	TC70545301	8CX-40C
Indicating											
3.5C	1	50	G	1.13 (28.7)	10.00 (254.0)	2 (0.91)	TC70544302	TC70544702	TC70545001	TC70545301	8CXI-3.5C
4C	1	50	G	1.13 (28.7)	10.00 (254.0)	2 (0.91)	TC70544302	TC70544702	TC70545001	TC70545301	8CXI-4C
4.5C	1	50	G	1.13 (28.7)	10.00 (254.0)	2 (0.91)	TC70544301	TC70544701	TC70545001	TC70545301	8CXI-4.5C
6C	1	50	G	1.13 (28.7)	10.00 (254.0)	2 (0.91)	TC70544301	TC70544701	TC70545001	TC70545301	8CXI-6C
7C	1	50	G	1.13 (28.7)	10.00 (254.0)	2 (0.91)	TC70544302	TC70544702	TC70545001	TC70545301	8CXI-7C
8C	1	50	G	1.13 (28.7)	10.00 (254.0)	2 (0.91)	TC70544301	TC70544701	TC70545001	TC70545301	8CXI-8C
10C	1	50	G	1.13 (28.7)	10.00 (254.0)	2 (0.91)	TC70544301	TC70544701	TC70545001	TC70545301	8CXI-10C
12C	1	50	G	1.13 (28.7)	10.00 (254.0)	2 (0.91)	TC70544301	TC70544701	TC70545001	TC70545301	8CXI-12C
15C	1	50	G	1.13 (28.7)	10.00 (254.0)	2 (0.91)	TC70544302	TC70544702	TC70545001	TC70545301	8CXI-15C
18C	1	50	G	2.00 (50.8)	10.00 (254.0)	2 (0.91)	TC70544301	TC70544701	TC70545001	TC70545301	8CXI-18C
20C	1	50	G	2.00 (50.8)	10.00 (254.0)	2 (0.91)	TC70544301	TC70544701	TC70545001	TC70545301	8CXI-20C
25C	1	50	G	2.00 (50.8)	10.00 (254.0)	2 (0.91)	TC70544301	TC70544701	TC70545001	TC70545301	8CXI-25C
30C	1	50	G	2.00 (50.8)	10.00 (254.0)	2 (0.91)	TC70544301	TC70544701	TC70545001	TC70545301	8CXI-30C
35C	1	50	G	2.00 (50.8)	10.00 (254.0)	2 (0.91)	TC70544302	TC70544702	TC70545001	TC70545301	8CXI-35C
40C	1	50	G	2.00 (50.8)	10.00 (254.0)	2 (0.91)	TC70544301	TC70544701	TC70545001	TC70545301	8CXI-40C

CX Type Mountings and Hardware 8.3 kV Maximum (7.2 kV Nominal)

Ampere Rating	Fuse Mounting Type ^①	Size	Voltage BIL (kV)	Mounting (Including Live Parts, End Fittings) ^②		Live Parts (Including End Fittings) ^②	End Fittings (Disconnect Only)
				Porcelain Insulator Catalog Number	Glass-Polyester Insulator Catalog Number		
3.5C-40C	Non-disconnect	B	75	—	8CX-GNM-G	CX-NL	—
	Disconnect	B	75	—	8CX-GDM-G	CX-DL	CX-DF

Notes

- ① See Page V14-T3-38 for diagram of typical mounting.
- ② End fittings supplied only when required.

CX Type



3

CX Type Current Limiting Fuses 15.5 kV Maximum (14.4 kV Nominal)

Current Rating (Amperes)	Barrel Number	Interrupting Rating rms (kA Sym.)	Fuse Mounting Code	Diameter	Length	Approximate Shipping Weight Lbs (kg)	Performance Curves			Catalog Number	
				Approximate Dimensions in Inches (mm)	Minimum Melting Time		Total Clearing Time	Peak Let-Through Current	I^2t		
Non-Indicating											
4C	1	50	G	2.00 (50.8)	14.30 (363.2)	2 (0.91)	TC70544401	TC70544801	TC70545002	TC70545401	15CX-4C
6C	1	50	G	2.00 (50.8)	14.30 (363.2)	2 (0.91)	TC70544401	TC70544801	TC70545002	TC70545401	15CX-6C
7C	1	50	G	2.00 (50.8)	14.30 (363.2)	2 (0.91)	TC70544402	TC70544802	TC70545002	TC70545401	15CX-7C
8C	1	50	G	2.00 (50.8)	14.30 (363.2)	2 (0.91)	TC70544401	TC70544801	TC70545002	TC70545401	15CX-8C
10C	1	50	G	2.00 (50.8)	14.30 (363.2)	2 (0.91)	TC70544401	TC70544801	TC70545002	TC70545401	15CX-10C
12C	1	50	G	2.00 (50.8)	14.30 (363.2)	2 (0.91)	TC70544401	TC70544801	TC70545002	TC70545401	15CX-12C
15C	1	50	G	2.00 (50.8)	14.30 (363.2)	2 (0.91)	TC70544402	TC70544802	TC70545002	TC70545401	15CX-15C
18C	1	50	G	2.00 (50.8)	14.30 (363.2)	2 (0.91)	TC70544401	TC70544801	TC70545002	TC70545401	15CX-18C
20C	1	50	G	2.00 (50.8)	14.30 (363.2)	2 (0.91)	TC70544401	TC70544801	TC70545002	TC70545401	15CX-20C
25C	1	50	G	2.00 (50.8)	14.30 (363.2)	2 (0.91)	TC70544401	TC70544801	TC70545002	TC70545401	15CX-25C
30C	1	50	G	2.00 (50.8)	14.30 (363.2)	2 (0.91)	TC70544401	TC70544801	TC70545002	TC70545401	15CX-30C
40C	1	50	G	2.00 (50.8)	14.30 (363.2)	2 (0.91)	TC70544401	TC70544801	TC70545002	TC70545401	15CX-40C
Indicating											
4C	1	50	G	2.00 (50.8)	14.30 (363.2)	2 (0.91)	TC70544401	TC70544801	TC70545002	TC70545401	15CXI-4C
6C	1	50	G	2.00 (50.8)	14.30 (363.2)	2 (0.91)	TC70544401	TC70544801	TC70545002	TC70545401	15CXI-6C
7C	1	50	G	2.00 (50.8)	14.30 (363.2)	2 (0.91)	TC70544402	TC70544802	TC70545002	TC70545401	15CXI-7C
8C	1	50	G	2.00 (50.8)	14.30 (363.2)	2 (0.91)	TC70544401	TC70544801	TC70545002	TC70545401	15CXI-8C
10C	1	50	G	2.00 (50.8)	14.30 (363.2)	2 (0.91)	TC70544401	TC70544801	TC70545002	TC70545401	15CXI-10C
12C	1	50	G	2.00 (50.8)	14.30 (363.2)	2 (0.91)	TC70544401	TC70544801	TC70545002	TC70545401	15CXI-12C
15C	1	50	G	2.00 (50.8)	14.30 (363.2)	2 (0.91)	TC70544402	TC70544802	TC70545002	TC70545401	15CXI-15C
18C	1	50	G	2.00 (50.8)	14.30 (363.2)	2 (0.91)	TC70544401	TC70544801	TC70545002	TC70545401	15CXI-18C
20C	1	50	G	2.00 (50.8)	14.30 (363.2)	2 (0.91)	TC70544401	TC70544801	TC70545002	TC70545401	15CXI-20C
25C	1	50	G	2.00 (50.8)	14.30 (363.2)	2 (0.91)	TC70544401	TC70544801	TC70545002	TC70545401	15CXI-25C
30C	1	50	G	2.00 (50.8)	14.30 (363.2)	2 (0.91)	TC70544401	TC70544801	TC70545002	TC70545401	15CXI-30C
40C	1	50	G	2.00 (50.8)	14.30 (363.2)	2 (0.91)	TC70544401	TC70544801	TC70545002	TC70545401	15CXI-40C

CX Type Mountings and Hardware 15.5 kV Maximum (14.4 kV Nominal)

Ampere Rating	Fuse Mounting Type ①	Size	Voltage BIL (kV)	Mounting (Including Live Parts, End Fittings) ②		Live Parts (Including End Fittings) ②	End Fittings (Disconnect Only)
				Porcelain Insulator Catalog Number	Glass-Polyester Insulator Catalog Number		
4C-40C	Non-disconnect	C	95	—	15CX-GNM-G	CX-NL	—
	Disconnect	C	95	—	15CX-GDM-G	CX-DL	CX-DF

Notes

- ① See Page V14-T3-38 for diagram of typical mounting.
- ② End fittings supplied only when required.

CXN Type

Type CXN



CXN Type Current Limiting Fuses 8.3 kV Maximum (7.2 kV Nominal)

Current Rating (Amperes)	Barrel Number	Interrupting Rating rms (kA Sym.)	Diameter	Length	Approximate Shipping Weight Lbs (kg)	Performance Curves			Catalog Number
			Approximate Dimensions in Inches (mm)	Minimum Melting Time		Total Clearing Time	Peak Let-Through Current		
60C	1	50	3.00 (76.2)	18.80 (477.5)	8 (3.63)	TC66675102	TC66675202	TC66664902	8CXN-60C
100C	1	50	3.00 (76.2)	18.80 (477.5)	8 (3.63)	TC66675102	TC66675202	TC66664902	8CXN-100C
125C	1	50	4.00 (101.6)	18.80 (477.5)	14 (6.36)	TC66675102	TC66675202	TC66664902	8CXN-125C
150C	1	50	4.00 (101.6)	18.80 (477.5)	14 (6.36)	TC66675102	TC66675202	TC66664902	8CXN-150C
200C	1	50	4.00 (101.6)	18.80 (477.5)	14 (6.36)	TC66675102	TC66675202	TC66664902	8CXN-200C
250C	1	50	4.00 (101.6)	18.80 (477.5)	14 (6.36)	TC66675102	TC66675202	TC66664902	8CXN-250C
120C	2	50	3.00 (76.2)	18.80 (477.5)	16 (7.26)	TC66675104	TC66675204	TC66664902	2 X 60C 8CXN-120C
200C	2	50	3.00 (76.2)	18.80 (477.5)	16 (7.26)	TC66675104	TC66675204	TC66664902	2 X 100C 8CXN-200C
250C	2	50	3.00 (76.2)	18.80 (477.5)	16 (7.26)	TC66675104	TC66675204	TC66664902	2 X 125C 8CXN-250C
300C	2	50	4.00 (101.6)	18.80 (477.5)	28 (12.71)	TC66675104	TC66675204	TC66664902	2 X 150C 8CXN-300C

CXN Type Mountings and Hardware 8.3 kV Maximum (7.2 kV Nominal)

Ampere Rating	Fuse Mounting Type ^①	Voltage LIWL (BIL)	Glass Polyester Insulator Mounting (Including Live Parts, End Fittings) ^② Catalog Number	Live Parts ^② Catalog Number	End Fittings (Disconnect Only) Catalog Number
60C–100C Single barrel	Non-disconnect	95	15CXN-GNM-D	15CXN-NL-D	—
	Non-disconnect	95	15CXN-GNM-G	15CXN-NL-G	—
	Disconnect	95	15CXN-GDM-G	15CXN-DL-G	15CXN-DF-G
125C–250C Single barrel	Non-disconnect	95	15CXN-GNM-F	15CXN-NL-F	—
	Non-disconnect	95	15CXN-GNM-G	15CXN-NL-G	—
	Disconnect	95	25CXN-GDM-G	15CXN-DL-G	15CXN-DF-G
120C, 200C Double barrel	Non-disconnect	95	15CXN-GNM-D	15CXN-NL-D	—
250C, 300C Double barrel	Non-disconnect	95	15CXN-GNM-F	15CXN-NL-F	—

Notes

- ① See Page V14-T3-38 for diagram of typical mounting.
- ② End fittings supplied only when required.

CXN Type



3

CXN Type Current Limiting Fuses 15.5 kV Maximum (14.4 kV Nominal)

Current Rating (Amperes)	Barrel Number	Interrupting Rating rms (kA Sym.)	Diameter	Length	Approximate Shipping Weight Lbs (kg)	Performance Curves			Catalog Number
			Approximate Dimensions in Inches (mm)			Minimum Melting Time	Total Clearing Time	Peak Let-Through Current	
45C	1	50	3.00 (76.2)	18.80 (477.5)	8 (3.63)	TC66674802	TC66675002	TC66665002	15CXN-45C
60C	1	50	3.00 (76.2)	18.80 (477.5)	8 (3.63)	TC66674802	TC66675002	TC66665002	15CXN-60C
75C	1	50	4.00 (101.6)	18.80 (477.5)	14 (6.36)	TC66674802	TC66675002	TC66665002	15CXN-75C
85C	1	50	4.00 (101.6)	18.80 (477.5)	14 (6.36)	TC66674802	TC66675002	TC66665002	15CXN-85C
100C	1	50	4.00 (101.6)	18.80 (477.5)	14 (6.36)	TC66674802	TC66675002	TC66665002	15CXN-100C
90C	2	50	3.00 (76.2)	18.80 (477.5)	16 (7.26)	TC66674804	TC66675004	TC66665002	2 X 45C 15CXN-90C
120C	2	50	3.00 (76.2)	18.80 (477.5)	16 (7.26)	TC66674804	TC66675004	TC66665002	2 X 60C 15CXN-120C
150C	2	50	4.00 (101.6)	18.80 (477.5)	28 (12.71)	TC66674804	TC66675004	TC66665002	2 X 75C 15CXN-150C
175C	2	50	4.00 (101.6)	18.80 (477.5)	28 (12.71)	TC66674804	TC66675004	TC66665002	2 X 85C 15CXN-175C

CXN Type Mountings and Hardware 15.5 kV Maximum (14.4 kV Nominal)

Ampere Rating	Fuse Mounting Type ^①	Voltage LIWL (BIL)	Glass Polyester Insulator Mounting (Including Live Parts, End Fittings) ^② Catalog Number	Live Parts ^② Catalog Number	End Fittings (Disconnect Only) Catalog Number
45C–60C Single barrel	Non-disconnect	95	15CXN-GNM-D	15CXN-NL-D	—
	Non-disconnect	95	15CXN-GNM-G	15CXN-NL-G	—
	Disconnect	95	15CXN-GDM-G	15CXN-DL-G	15CXN-DF-G
75C–100C Single barrel	Non-disconnect	95	15CXN-GNM-F	15CXN-NL-F	—
	Non-disconnect	95	15CXN-GNM-G	15CXN-NL-G	—
	Disconnect	95	25CXN-GDM-G	15CXN-DL-G	15CXN-DF-G
90C, 120C Double barrel	Non-disconnect	95	15CXN-GNM-D	15CXN-NL-D	—
150C, 175C Double barrel	Non-disconnect	95	15CXN-GNM-F	15CXN-NL-F	—

Notes

^① See **Page V14-T3-38** for diagram of typical mounting.

^② End fittings supplied only when required.

Dimensions

Approximate Dimensions in Inches (mm).

CXN Type Fuse

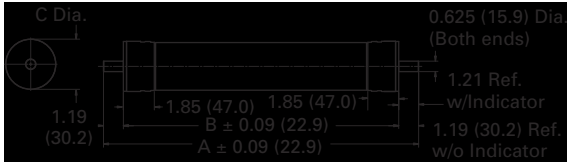

CXN Type Fuse Dimensional Details

Maximum kV	Ampere Rating	Dimensions		
		A	B	C
8.3	60-100	18.86 (479.0)	16.41 (416.8)	3.00 (76.2)
8.3	125-250	18.86 (479.0)	16.41 (416.8)	4.00 (101.6)
15.5	45-60	18.86 (479.0)	18.86 (479.0)	3.00 (76.2)
15.5	75-100	18.86 (479.0)	18.86 (479.0)	4.00 (101.6)

CX Type Fuse

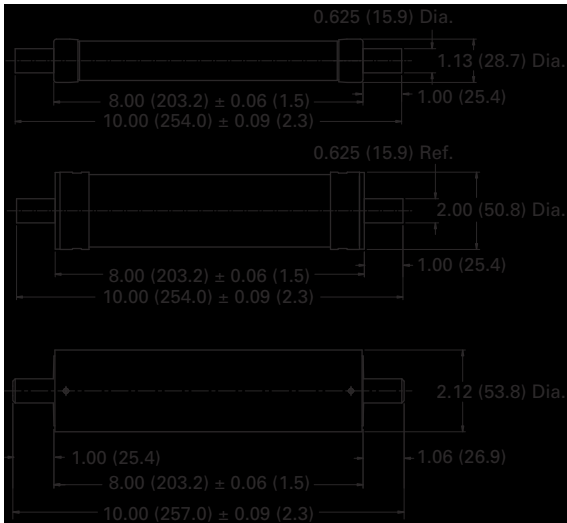

3.9

Current Limiting Fuses

DSL, MDSL and NPL Type Low Voltage Current Limiters

DSL Current Limiters

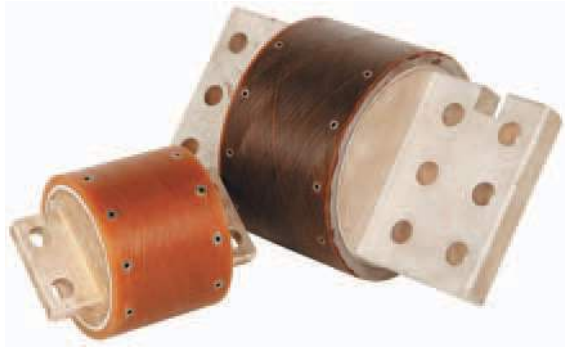

3

Contents

Description

Page

DSL, MDSL and NPL Type Low Voltage Current Limiters

Product Selection **V14-T3-77**

DSL, MDSL and NPL Type Low Voltage Current Limiters

Product Description

Refer to DSL, Magnum™ DSL or NPL sections of this catalog for product description and application guidelines.

DSL, MDSL and NPL Type Low Voltage Current Limiters

Product Selection

The following current limiters are available as renewal/replacement parts for use in conjunction with DLL, MDSL low voltage power circuit breakers, and network protectors.

Types DSL, MDSL and NPL

Maximum Design Voltage	Interrupting Rating (kA Sym.)	Catalog Number	Style Number	Approx. Shipping Weight Lbs (kg)	Average Melting Time	Peak Let-Through Current
600	200	6DSL-A150	140D816G01	3.00 (1.4)	TC63977102	TC63977202
600	200	6DSL-A200	140D816G02	3.00 (1.4)	TC63977102	TC63977202
600	200	6DSL-A250	140D816G03	3.00 (1.4)	TC63977102	TC63977202
600	200	6DSL-A300	140D816G04	3.00 (1.4)	TC63977102	TC63977202
600	200	6DSL-A400	140D816G05	3.00 (1.4)	TC63977102	TC63977202
600	200	6DSL-A600	140D816G06	3.00 (1.4)	TC63977102	TC63977202
600	200	6DSL-A800	140D816G07	3.00 (1.4)	TC63977102	TC63977202
600	200	6DSL-B1200	140D816G10	4.00 (1.8)	TC63977102	TC63977202
600	200	6DSL-B1600	140D816G11	4.00 (1.8)	TC63977102	TC63977202
600	200	6DSL-B3000	140D816G12	4.00 (1.8)	TC63977102	TC63977202
600	200	6DSL-C800	151D982G01	5.50 (2.5)	TC63943102	TC63943202
600	200	6DSL-C1000	151D982G02	5.50 (2.5)	TC63943102	TC63943202
600	200	6DSL-C1200	151D982G03	5.50 (2.5)	TC63943102	TC63943202
600	200	6DSL-C1600	151D982G04	5.50 (2.5)	TC63943102	TC63943202
600	200	6DSL-C2000	151D982G05	5.50 (2.5)	TC63943102	TC63943202
600	200	6DSL-D2500	151D982G09	8.50 (3.9)	TC63943102	TC63943202
600	200	6DSL-D3000	151D982G10	8.50 (3.9)	TC63943102	TC63943202
600	200	6DSL-E2500	5980C01G01	20.0 (9.1)	TC70550302	TC70550402
600	200	6DSL-E3000	5980C01G02	20.0 (9.1)	TC70550302	TC70550402
600	200	6DSL-E4000	5980C01G03	20.0 (9.1)	TC70550302	TC70550402
600	200	6DSL-F5000	5980C01G04	24.0 (10.9)	TC70550302	TC70550402
600	200	6MDSL-MA150	5982C90G01	3.00 (1.4)	TC63977103	TC63977202
600	200	6MDSL-MA200	5982C90G02	3.00 (1.4)	TC63977103	TC63977202
600	200	6MDSL-MA250	5982C90G03	3.00 (1.4)	TC63977103	TC63977203
600	200	6MDSL-MA300	5982C90G04	3.00 (1.4)	TC63977103	TC63977203
600	200	6MDSL-MA400	5982C90G05	3.00 (1.4)	TC63977103	TC63977203
600	200	6MDSL-MA600	5982C90G07	3.00 (1.4)	TC63977103	TC63977203
600	200	6MDSL-MA800	5982C90G08	3.00 (1.4)	TC63977103	TC63977203
600	200	6MDSL-MB-1200	5981C91G01	4.00 (1.8)	TC63977103	TC63977203
600	200	6MDSL-MB-1600	5981C91G02	4.00 (1.8)	TC63977103	TC63977203
600	200	6MDSL-MB-2000	5981C91G03	4.00 (1.8)	TC63977103	TC63977203
600	200	6MDSL-MC-800	5981C92G01	5.50 (2.5)	TC63943102	TC63943202
600	200	6MDSL-MC-1000	5981C92G02	5.50 (2.5)	TC63943102	TC63943202
600	200	6MDSL-MC-1200	5981C92G03	5.50 (2.5)	TC63943102	TC63943202
600	200	6MDSL-MC-1600	5981C92G04	5.50 (2.5)	TC63943102	TC63943202
600	200	6MDSL-MC-2000	5981C92G05	5.50 (2.5)	TC63943102	TC63943202
600	200	6MDSL-MD2500	5981C93G01	8.50 (3.9)	TC63977103	TC63977203
600	200	6MDSL-MD3000	5981C93G02	8.50 (3.9)	TC63977103	TC63977203
480	150	4NPL-900	140D318G04	—	TC63942802	TC63942803
480	150	4NPL-1300	140D318G05	—	TC63942803	TC63942803
480	150	4NPL-1875	140D318G01	—	TC63942804	TC63942803
480	150	4NPL-2000	140D318G07	—	TC63942805	TC63942803
480	150	4NPL-2825	140D318G02	—	TC63942806	TC63942803
480	150	4NPL-3000	140D318G06	—	TC63942807	TC63942803
480	200	4NPL-3500	5982C64G01	—	TC70550306	—
480	200	4NPL-5000	5982C64G02	—	TC70550306	—

3.9

Current Limiting Fuses