

Device Features

- +5V/330mA at operating bias condition
- Gain = 20.8 dB @ 3500 MHz
- P1dB = 31.5 dBm @ 3500 MHz
- 5G NR ACLR = 18dBm Output Power at -50dBc @ 3500 MHz
- Intergrated interstage matching
- Green/RoHS2-compliant QFN3x3 SMT package



Product Description

The BMT352 is a high dynamic range two-stage power amplifier, housed in a green/RoHS2 compliant 3x3mm² QFN package. The BMT352 uses a high reliability InGaP/GaAs HBT process technology. The BMT352 is designed for use where high linearity and gain are required. The BMT352 is able to typically delivers 18 dBm output power from 3000 to 4000 MHz while maintaining superior ACLR performance with a few external matching components. All devices are 100% RF/DC screened.

Applications

- Base station/Repeaters Infrastructure/Small Cell
- Commercial/Industrial/Military wireless system
- LTE / WCDMA / CDMA Wireless Infrastructure

Application Circuits

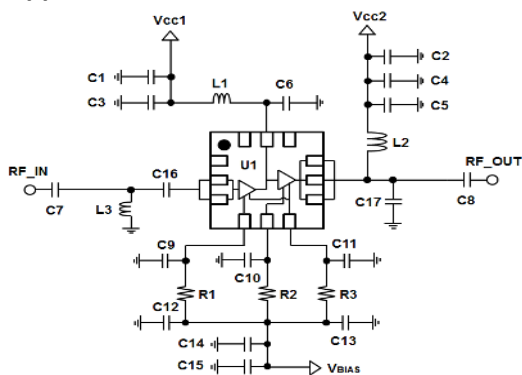

*External matching circuit: refer to the page 5 to 17.

Electrical Specifications

Device performance _ measured on a BeRex evaluation board at 25°C, Vc=5V, 50 Ω system.

Parameter	Conditions	Min	Typ	Max	Unit
Operational Frequency Range		3000		4000	MHz
Test Frequency			3500		MHz
Gain		19.3	20.8		dB
Input Return Loss			-17.0		dB
Output Return Loss			-9.0		dB
Output IP3	17 dBm/tone, Δf=1 MHz	45.0	48.0		dBm
Output P1dB		30.5	31.5		dBm
5G NR ACLR*		17.0	18.0		dBm
Noise Figure			5.1		dB

*ACLR Channel Power measured at -50dBc.

- 5G set-up: 3GPP 5G NR, 100MHz BW, ±100MHz offset, PAR 9.5 at 0.01% Prob.

Recommended Operating Conditions

Parameter	Min	Typ	Max	Unit
Bandwidth	3000		4000	MHz
I _{bias} @ (I _{REF1&2} + I _{B1&2})	21	26	31	mA
I _{cq} @ (I _{cq1} + I _{cq2})	270	330	390	mA
V _{CC} /V _{bias}	4.75	5.0	5.25	V
R _{TH}		12.9		°C/W
Operating Case Temperature	-40		+105	°C

Electrical specifications are measured at specified test conditions.

Specifications are not guaranteed over all recommended operating conditions.

Absolute Maximum Ratings

Parameter	Rating	Unit
Storage Temperature	-55 to +155	°C
Junction Temperature	+175	°C
Supply Voltage	+6.0	V
Supply Current	1.5	A
Input RF Power	26	dBm

*Operation of this device above any of these parameters may result in permanent damage.

Typical Performance (V_{cc} & V_{Bias} = +5V, I_{cq} = 330mA, T_a = 25 °C)

Parameter	Frequency					Unit
	3400	3500	3600	3700	3800	MHz
Gain	21.0	20.8	20.7	20.5	20.2	dB
S11	-17.0	-17.0	-16.8	-17.0	-15.3	dB
S22	-10.7	-9.0	-7.8	-5.5	-3.8	dB
OIP3	50.0	48.0	46.2	43.0	40.6	dBm
P1dB	30.8	31.5	31.2	31.4	31.4	dBm
5G NR ACLR	17.0	18.0	17.9	18.0	16.2	dBm
Noise Figure	5.1	5.1	5.2	5.5	5.8	dB

V-I Characteristics

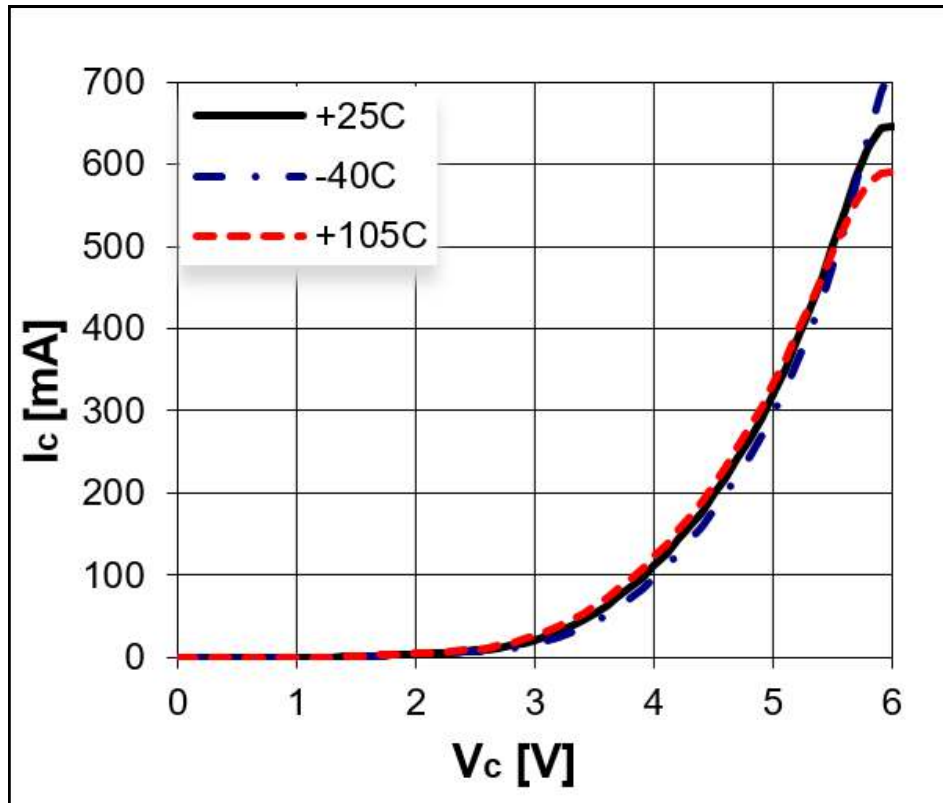

Pin Configuration

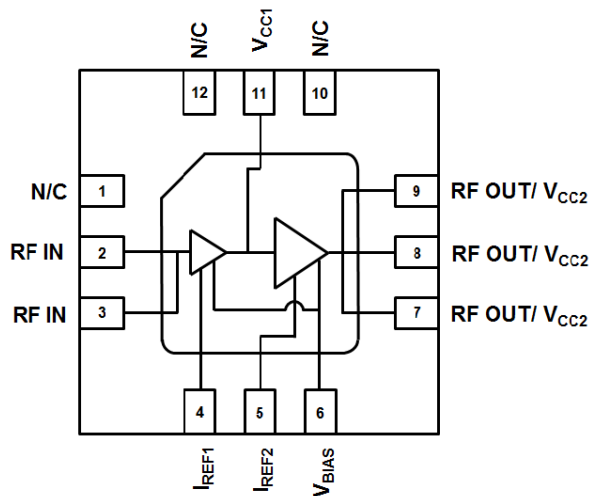

Pin No.	Label
1,10,12	N/C
2,3	RF IN
4	I _{REF1}
5	I _{REF2}
6	V _{Bias}
7,8,9	RF OUT/V _{CC2}
11	V _{CC1}
Backside Paddle	GND

BeRex Evaluation Board

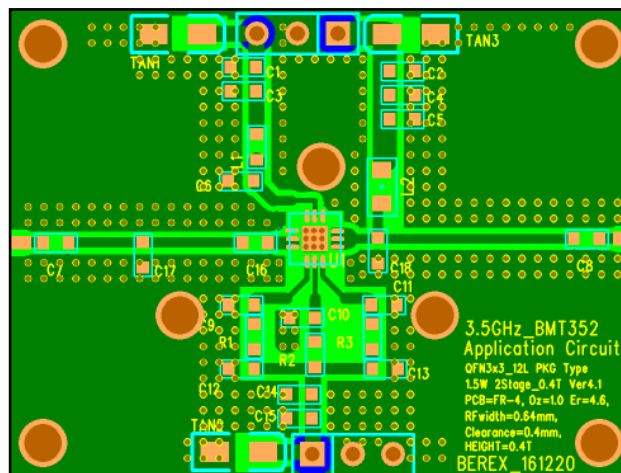
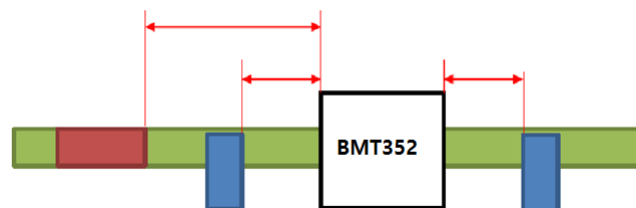
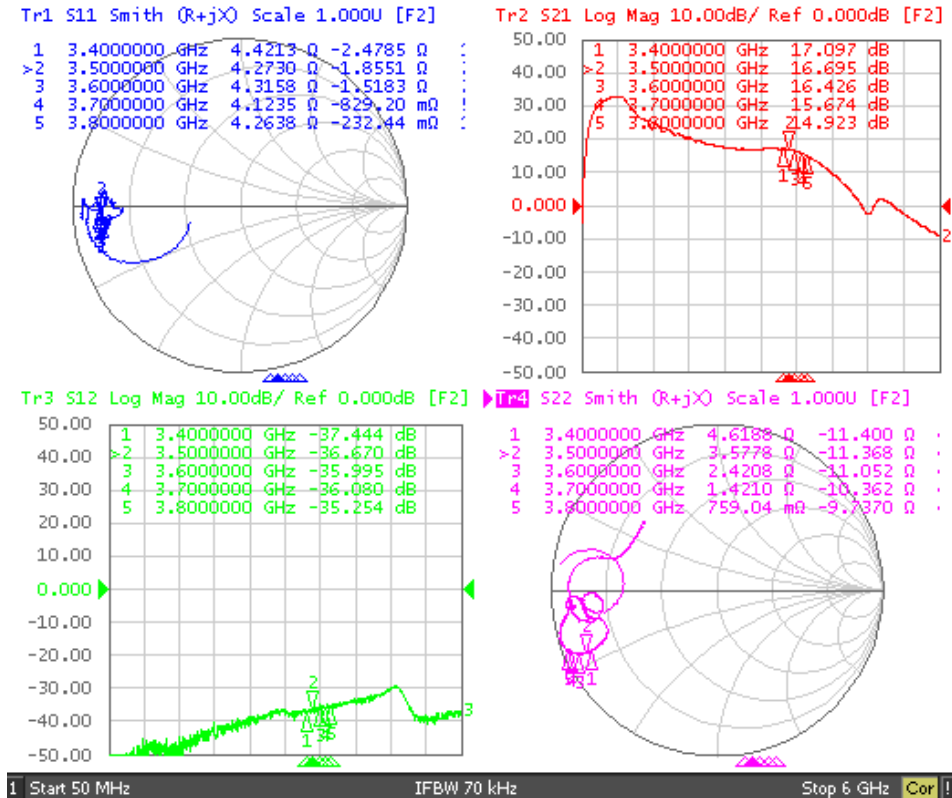

Figure about the reference position of components



Typical Device Data

S-parameters (V_{cc} & V_{Bias} = +5V, I_{cq} =330mA, T_a =25°C)



S-Parameter

(V_{cc} & V_{Bias} = +5V, I_{cq} = 330mA, T_a = 25 °C, calibrated to device leads)

Freq [MHz]	S11		S21		S12		S22	
	[Mag]	[Ang]	[Mag]	[Ang]	[Mag]	[Ang]	[Mag]	[Ang]
3000	0.85	-169.83	6.80	131.45	0.01	84.90	0.70	-163.38
3100	0.85	-171.29	7.13	125.18	0.01	82.11	0.72	-157.60
3200	0.85	-172.08	7.15	112.90	0.01	84.13	0.77	-155.37
3300	0.84	-173.58	7.13	104.15	0.01	85.52	0.80	-154.65
3400	0.84	-174.18	7.12	91.77	0.01	83.96	0.84	-154.26
3500	0.84	-175.94	6.78	80.60	0.01	79.18	0.87	-154.55
3600	0.84	-176.75	6.57	68.06	0.02	83.97	0.91	-155.12
3700	0.85	-177.94	6.03	53.82	0.02	76.55	0.95	-156.77
3800	0.84	-179.59	5.55	42.73	0.02	73.93	0.96	-158.27
3900	0.84	179.08	4.86	28.34	0.02	68.24	0.98	-160.44
4000	0.84	177.56	4.28	18.35	0.02	63.23	0.98	-162.53

Application Circuit: 3400 MHz

Schematic Diagram	BOM	Marks		
	C1	0603	1uF	
	C2	0603	1uF	
	C3	0603	20pF	
	C4	0603	20pF	
	C5	0603	N/A	
	C6	0603	N/A	
	C7	0603	20pF	
	C8	0603	10pF	High Q Cap
	C9	0603	N/A	
	C10	0603	N/A	
	C11	0603	N/A	
	C12	0603	N/A	
	C13	0603	1pF	
	C14	0603	20pF	
	C15	0603	1uF	
	C16	0603	0.8pF	High Q Cap
	C17	0603	1.5pF	High Q Cap
	C18	0603	1.3pF	High Q Cap
L1	0603	0 Ω	Coilcraft-HQ	
L2	0805	12nH	Coilcraft-HQ	
R1	0603	330 Ω		
R2	0603	470 Ω		
R3	0603	20 Ω		

PCB Diagram	Notice												
	<p>In table below can be changed per substrate conditions</p> <table border="1"> <thead> <tr> <th>Reference</th> <th>Object</th> <th>Distance</th> </tr> </thead> <tbody> <tr> <td>Input pin</td> <td>C17</td> <td>9.3mm</td> </tr> <tr> <td>Input pin</td> <td>C16</td> <td>1.5mm</td> </tr> <tr> <td>Output pin</td> <td>C18</td> <td>2.1mm</td> </tr> </tbody> </table>	Reference	Object	Distance	Input pin	C17	9.3mm	Input pin	C16	1.5mm	Output pin	C18	2.1mm
	Reference	Object	Distance										
Input pin	C17	9.3mm											
Input pin	C16	1.5mm											
Output pin	C18	2.1mm											
<p>3.4GHz_BMT352 Application Circuit QFN3x3_12L PKG Type 1.5W 2Stage_D.4T Ver4.1 PCB=FR-4, Oz=1.0 Er=4.6, RF width=0.64mm, Clearance=0.4mm, HEIGHT=0.4T BEREX_161220</p>	<p>1. C8 & C17 & C16 & C18 : We recommend High-Q capacitor for better output power performance. We used Johanson Tech's capacitor .</p>												

Typical Performance

(V_{CC} & $V_{Bias} = +5V$, $I_{CQ} = 330mA$, $T_a = 25\text{ }^\circ C$)

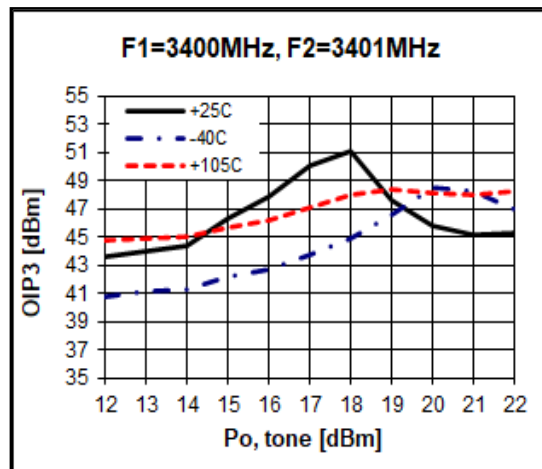
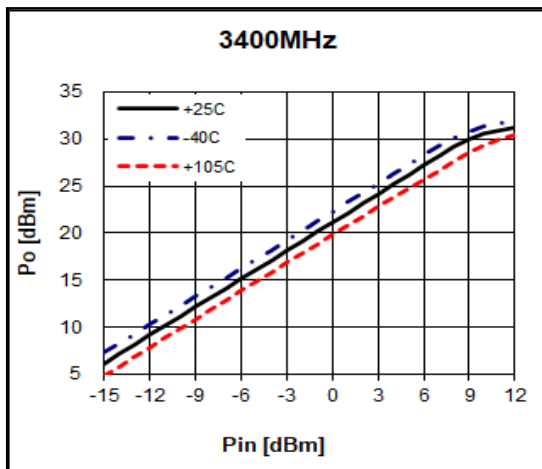
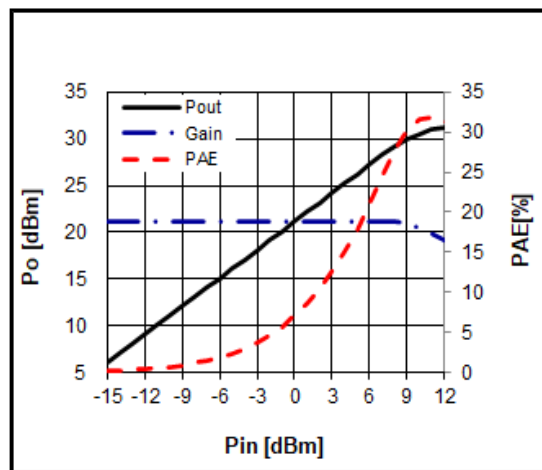
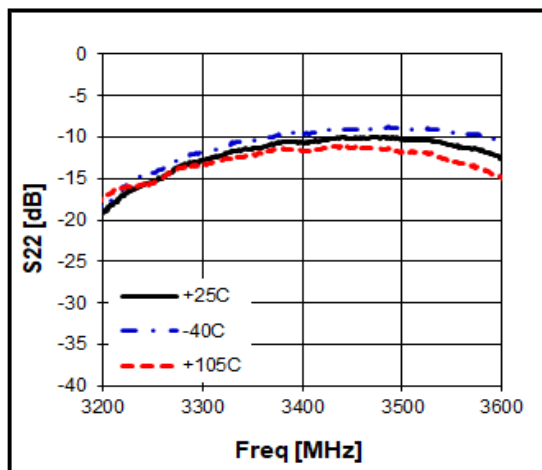
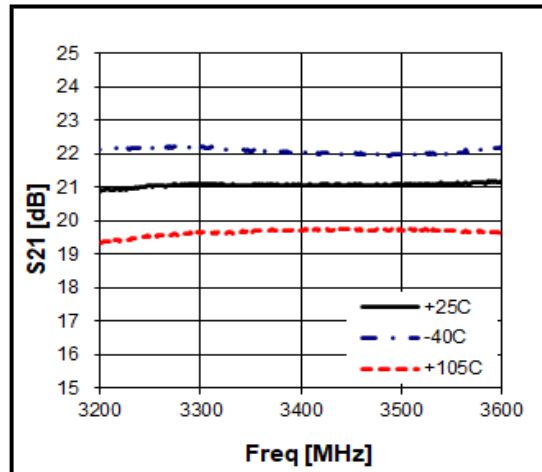
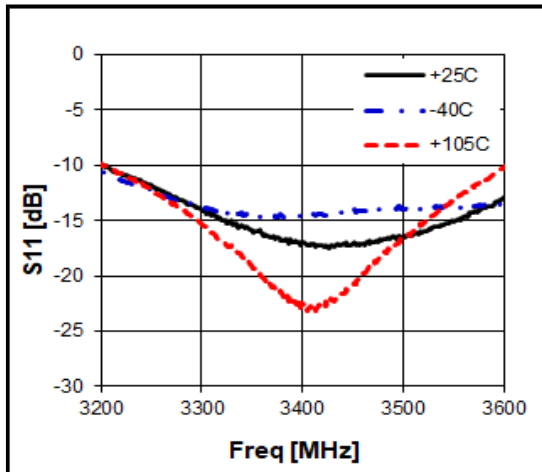

3GPP 5G NR 1FA ACLR 3.4GHz

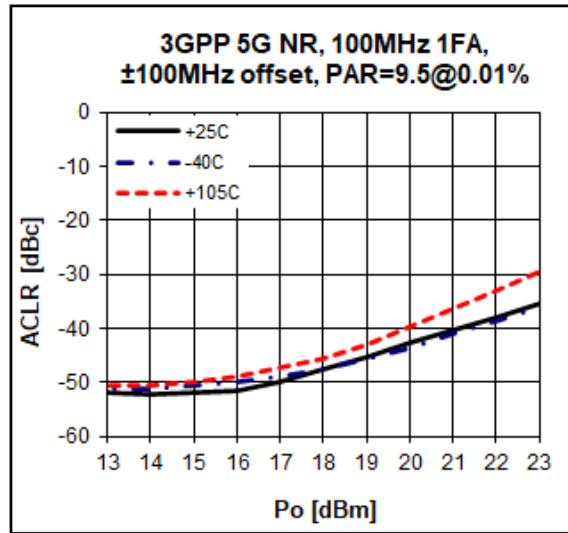

3GPP 5G NR 1FA ACLR (-50dBc)

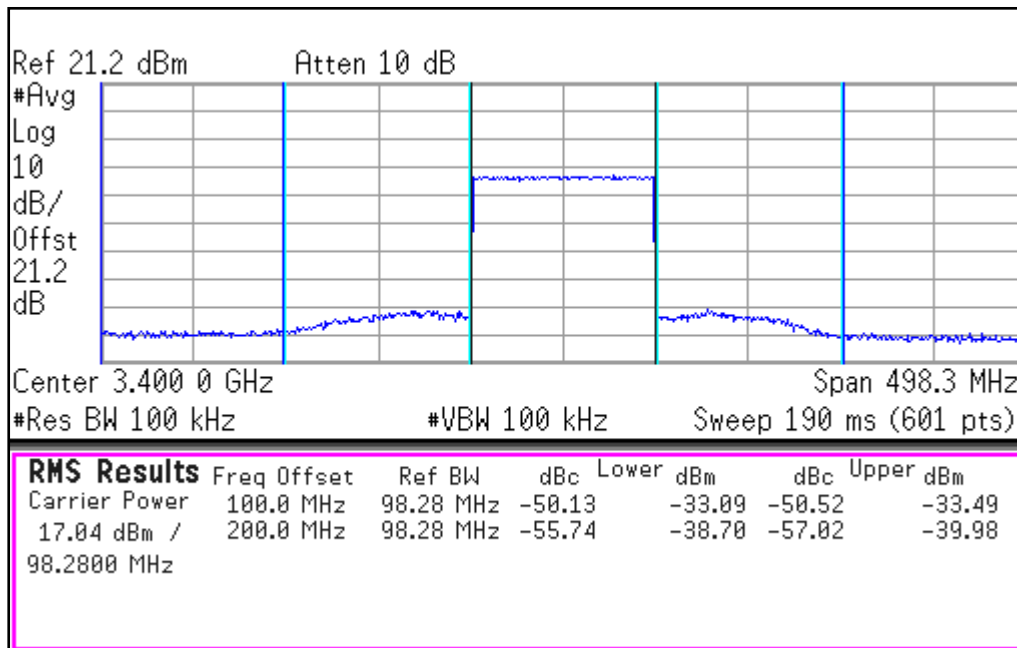

Application Circuit: 3500 MHz

Schematic Diagram	BOM	Marks		
	C1	0603	1uF	
	C2	0603	1uF	
	C3	0603	20pF	
	C4	0603	20pF	
	C5	0603	N/A	
	C6	0603	N/A	
	C7	0603	20pF	
	C8	0603	10pF	High Q Cap
	C9	0603	N/A	
	C10	0603	N/A	
	C11	0603	N/A	
	C12	0603	N/A	
	C13	0603	2pF	
	C14	0603	20pF	
	C15	0603	1uF	
	C16	0603	0.8pF	High Q Cap
	C17	0603	1.5pF	High Q Cap
	C18	0603	1.3pF	High Q Cap
L1	0603	0 Ω	Coilcraft-HQ	
L2	0805	12nH	Coilcraft-HQ	
R1	0603	330 Ω		
R2	0603	470 Ω		
R3	0603	20 Ω		

PCB Diagram	Notice												
	<p>In table below can be changed per substrate conditions</p> <table border="1"> <thead> <tr> <th>Reference</th> <th>Object</th> <th>Distance</th> </tr> </thead> <tbody> <tr> <td>Input pin</td> <td>C17</td> <td>9.1mm</td> </tr> <tr> <td>Input pin</td> <td>C16</td> <td>1.5mm</td> </tr> <tr> <td>Output pin</td> <td>C18</td> <td>2.0mm</td> </tr> </tbody> </table>	Reference	Object	Distance	Input pin	C17	9.1mm	Input pin	C16	1.5mm	Output pin	C18	2.0mm
	Reference	Object	Distance										
Input pin	C17	9.1mm											
Input pin	C16	1.5mm											
Output pin	C18	2.0mm											
<p>3.5GHz_BMT352 Application Circuit QFN3x3_12L PKG Type 1.5W 2Stage_0.4T Ver4.1 PCB=FR-4, Oz=1.0 Er=4.6, RFwidth=0.64mm, Clearance=0.4mm, HEIGHT=0.4T BEREX 161220</p>	<p>1. C8 & C17 & C16 & C18 : We recommend High-Q capacitor for better output power performance. We used Johanson Tech's capacitor .</p>												

Typical Performance

(V_{CC} & $V_{Bias} = +5V$, $I_{CQ} = 330mA$, $T_a = 25^\circ C$)

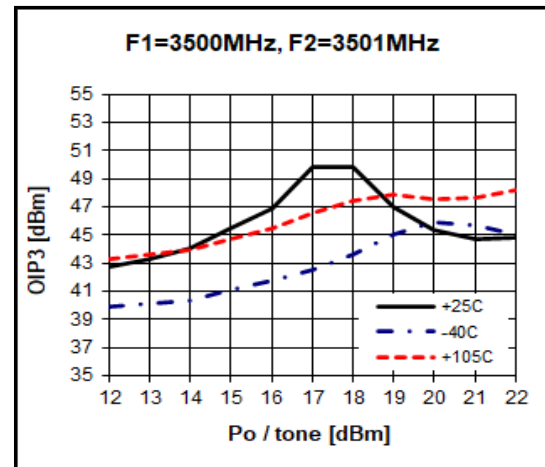
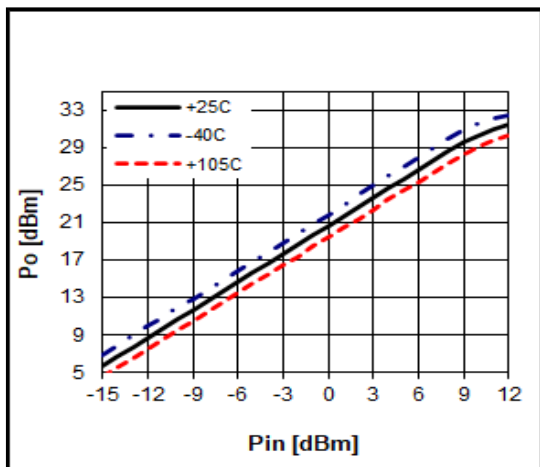
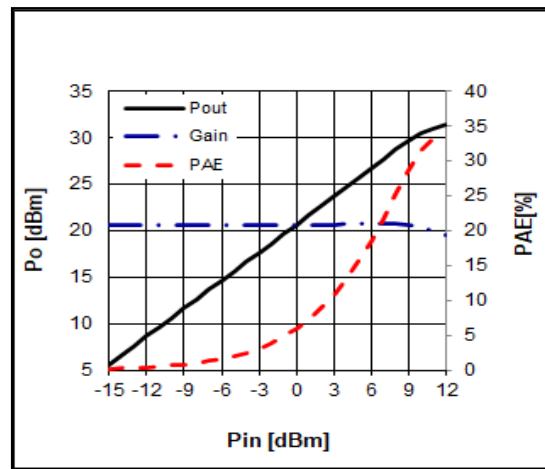
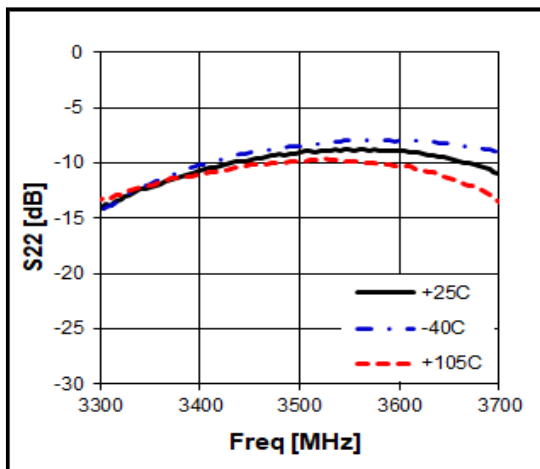
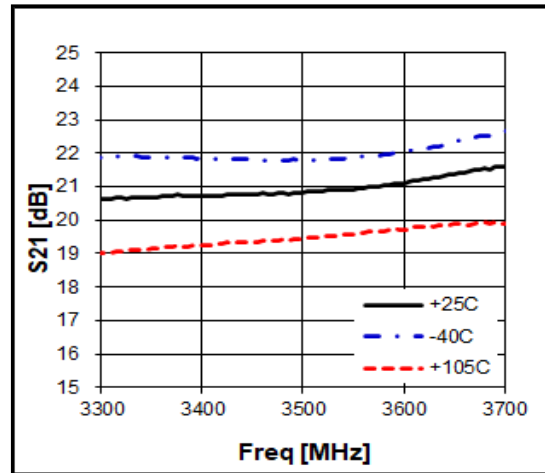
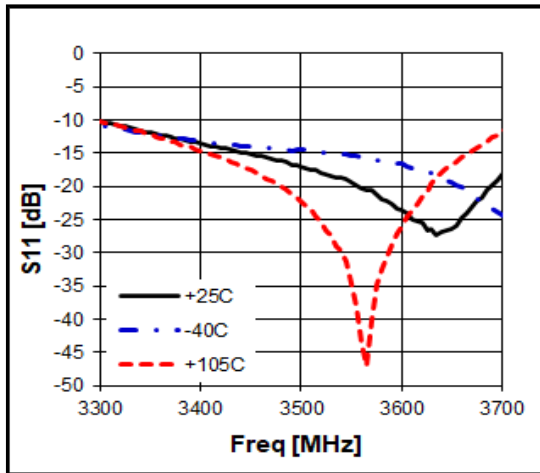

3GPP 5G NR 1FA ACLR 3.5GHz

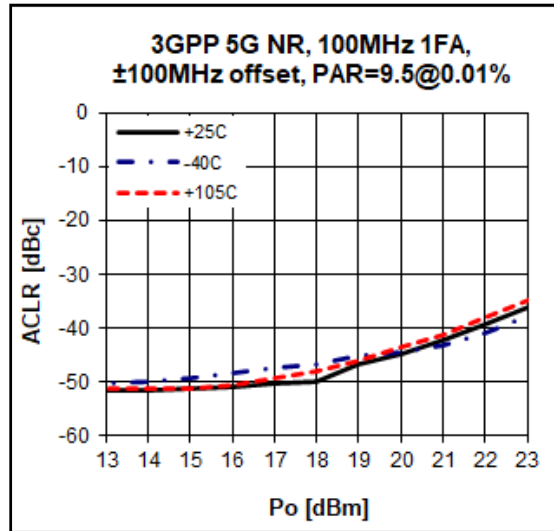

3GPP 5G NR 1FA ACLR (-50dBc)

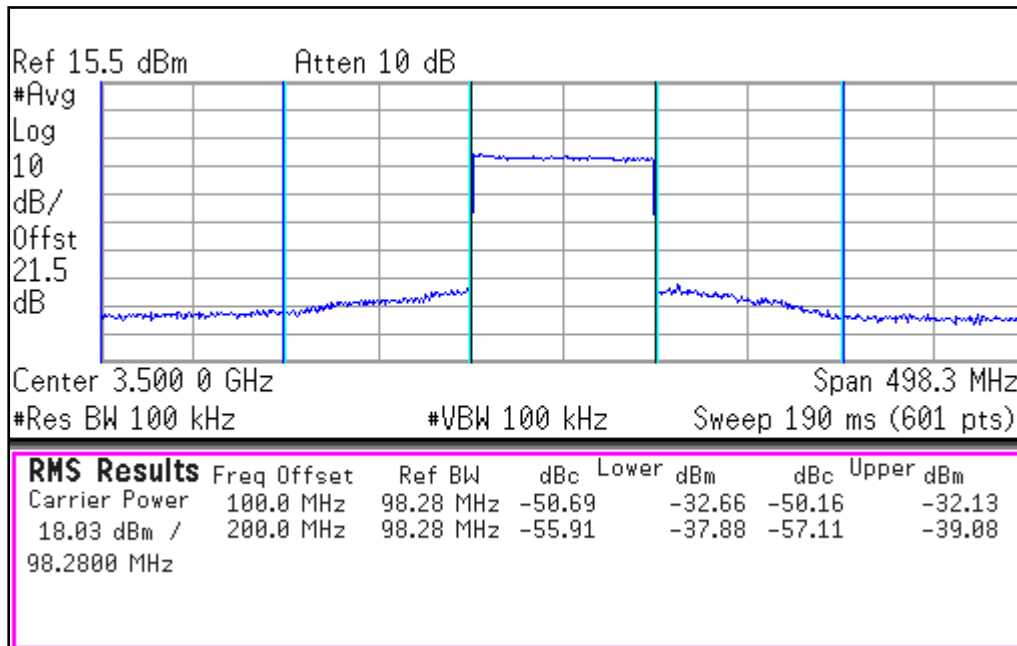

Application Circuit: 3600 MHz

Schematic Diagram	BOM	Marks		
	C1	0603	1uF	
	C2	0603	10uF	
	C3	0603	20pF	
	C4	0603	1uF	
	C5	0603	20pF	
	C6	0603	N/A	
	C7	0603	20pF	
	C8	0603	10pF	High Q Cap
	C9	0603	N/A	
	C10	0603	N/A	
	C11	0603	N/A	
	C12	0603	N/A	
	C13	0603	2pF	
	C14	0603	20pF	
	C15	0603	1uF	
	C16	0603	0.8pF	High Q Cap
	C17	0603	1.3pF	High Q Cap
	C18	0603	1.3pF	High Q Cap
	C19	0603	0.3pF	High Q Cap
L1	0603	0 Ω		
L2	0805	12nH	Coilcraft-HQ	
R1	0603	330 Ω		
R2	0603	470 Ω		
R3	0603	20 Ω		

PCB Diagram	Notice														
	In table below can be changed per substrate conditions														
	<table border="1" style="width: 100%; border-collapse: collapse;"> <thead> <tr> <th>Reference</th> <th>Object</th> <th>Distance</th> </tr> </thead> <tbody> <tr> <td>Input pin</td> <td>C17</td> <td>8.7mm</td> </tr> <tr> <td>Input pin</td> <td>C16</td> <td>1.5mm</td> </tr> <tr> <td>Output pin</td> <td>C18</td> <td>1.6mm</td> </tr> <tr> <td>Output pin</td> <td>C19</td> <td>3.5mm</td> </tr> </tbody> </table>	Reference	Object	Distance	Input pin	C17	8.7mm	Input pin	C16	1.5mm	Output pin	C18	1.6mm	Output pin	C19
Reference	Object	Distance													
Input pin	C17	8.7mm													
Input pin	C16	1.5mm													
Output pin	C18	1.6mm													
Output pin	C19	3.5mm													
<p>3.6GHz_BMT352 Application Circuit QFN3x3_12L PKG Type 1.5W 2Stage_D.4T Ver4.2 PCB=FR-4, Oz=1.0 Er=4.6, RF width=0.64mm, Clearance=0.4mm, HEIGHT=0.4T BEREX 161220</p>	<p>1. C8 & C17 & C16 & C18 & C19 : We recommend High-Q capacitor for better output power performance. We used Johanson Tech's capacitor .</p>														

Typical Performance

(V_{CC} & $V_{Bias} = +5V$, $I_{CQ} = 330mA$, $T_a = 25\text{ }^\circ C$)

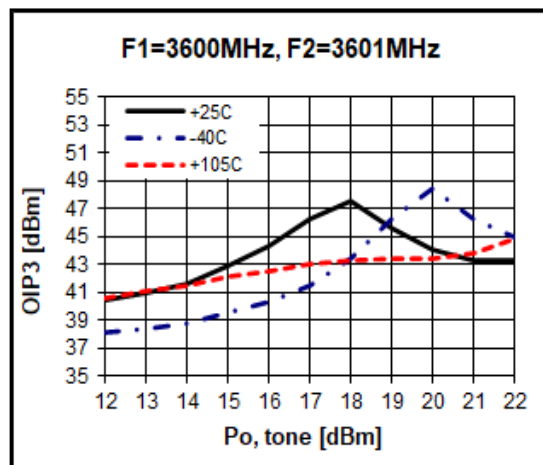
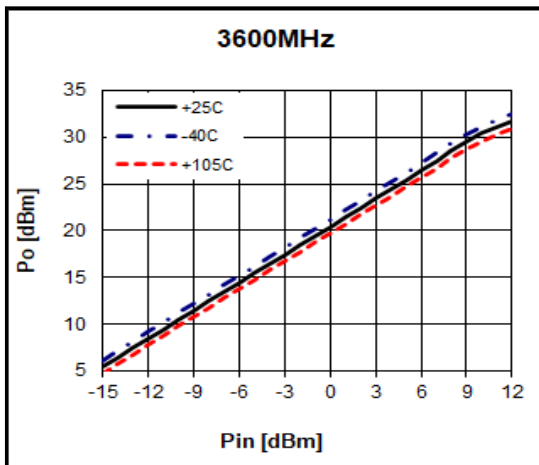
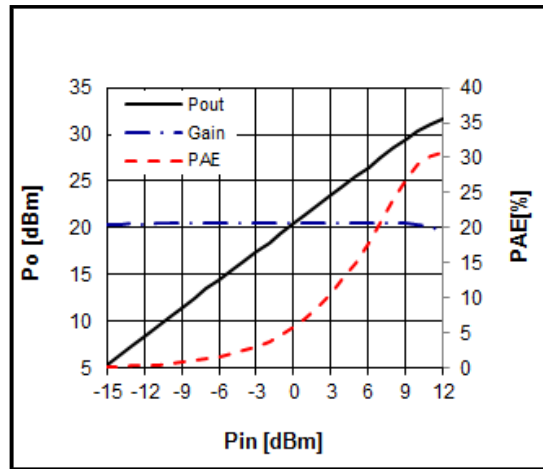
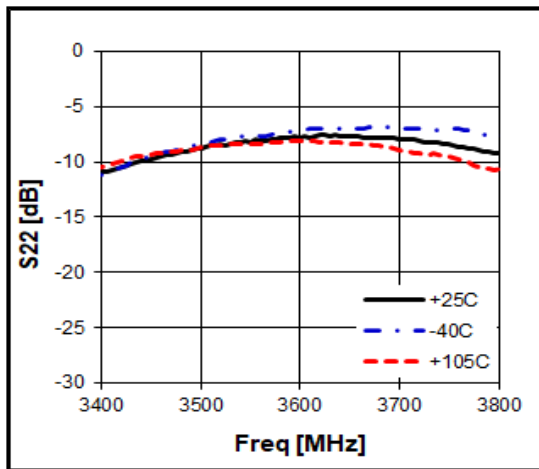
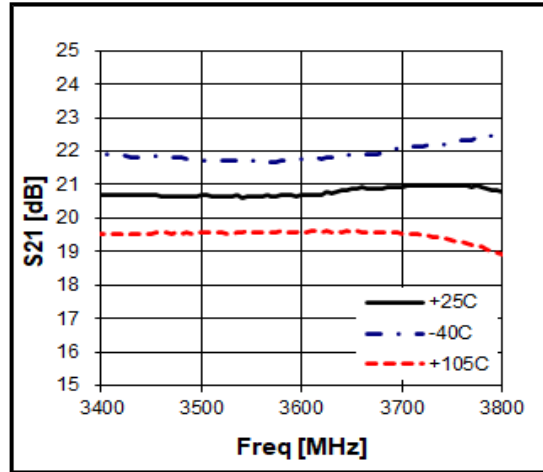
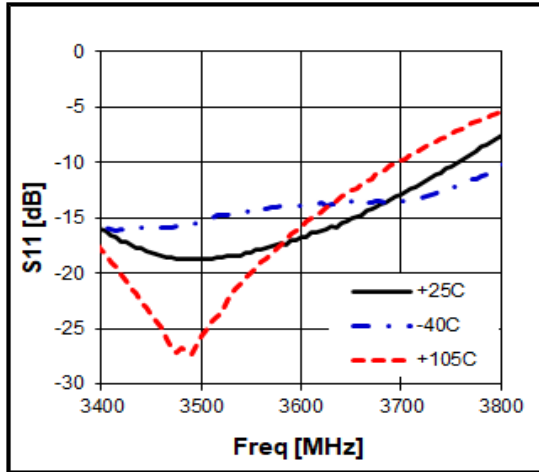

3GPP 5G NR 1FA ACLR 3.6GHz

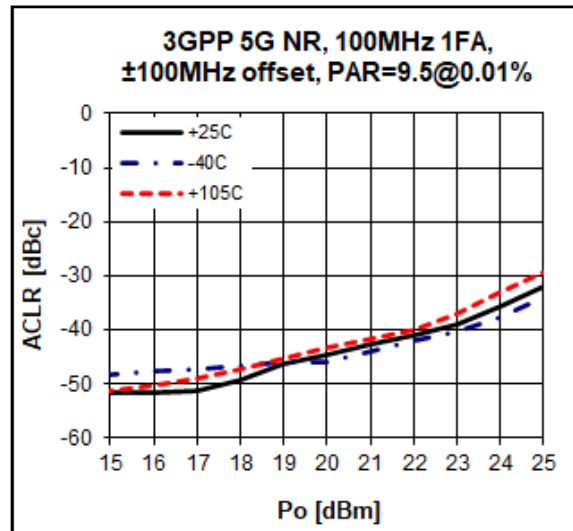

3GPP 5G NR 1FA ACLR (-50dBc)

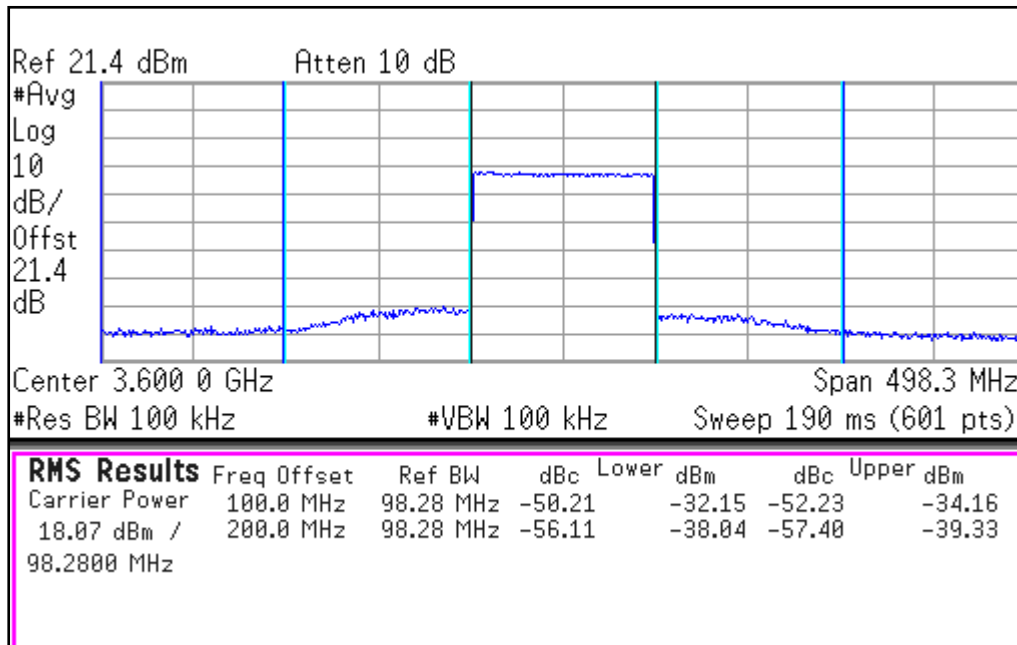

Application Circuit: 3700 MHz

Schematic Diagram	BOM	Marks		
	C1	0603	1uF	
	C2	0603	1uF	
	C3	0603	20pF	
	C4	0603	20pF	
	C5	0603	N/A	
	C6	0603	N/A	
	C7	0603	20pF	
	C8	0603	10pF	High Q Cap
	C9	0603	N/A	
	C10	0603	N/A	
	C11	0603	N/A	
	C12	0603	N/A	
	C13	0603	2pF	
	C14	0603	20pF	
	C15	0603	1uF	
	C16	0603	0.8pF	High Q Cap
	C17	0603	1.3pF	High Q Cap
	C18	0603	1.2pF	High Q Cap
	C19	0603	0.2pF	High Q Cap
L1	0603	0 Ω		
L2	0805	12nH	Coilcraft-HQ	
R1	0603	330 Ω		
R2	0603	470 Ω		
R3	0603	20 Ω		

PCB Diagram	Notice															
	In table below can be changed per substrate conditions															
	<table border="1" style="width: 100%; border-collapse: collapse;"> <thead> <tr> <th>Reference</th> <th>Object</th> <th>Distance</th> </tr> </thead> <tbody> <tr> <td>Input pin</td> <td>C17</td> <td>8.3mm</td> </tr> <tr> <td>Input pin</td> <td>C16</td> <td>1.5mm</td> </tr> <tr> <td>Output pin</td> <td>C18</td> <td>1.4mm</td> </tr> <tr> <td>Output pin</td> <td>C19</td> <td>2.9mm</td> </tr> </tbody> </table>	Reference	Object	Distance	Input pin	C17	8.3mm	Input pin	C16	1.5mm	Output pin	C18	1.4mm	Output pin	C19	2.9mm
	Reference	Object	Distance													
	Input pin	C17	8.3mm													
Input pin	C16	1.5mm														
Output pin	C18	1.4mm														
Output pin	C19	2.9mm														
<p>1. C8 & C17 & C16 & C18 & C19 : We recommend High-Q capacitor for better output power performance. We used Johanson Tech's capacitor .</p>																
<p>3.7GHz_BMT352 Application Circuit QFN3x3_12L PKG Type 1.5W 2Stage_0.4T Ver4.2 PCB=FR-4, Oz=1.0 Er=4.6, RFwidth=0.64mm, Clearance=0.4mm, HEIGHT=0.4T BEREX 161220</p>																

Typical Performance

(V_{CC} & $V_{Bias} = +5V$, $I_{CQ} = 330mA$, $T_a = 25\text{ }^\circ C$)

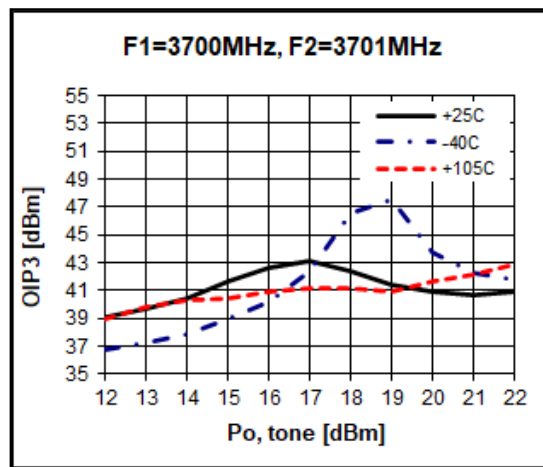
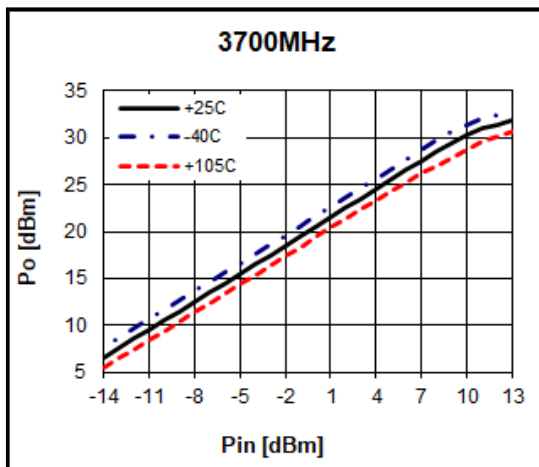
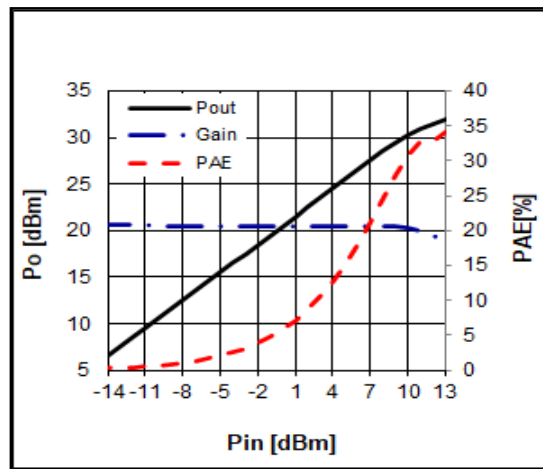
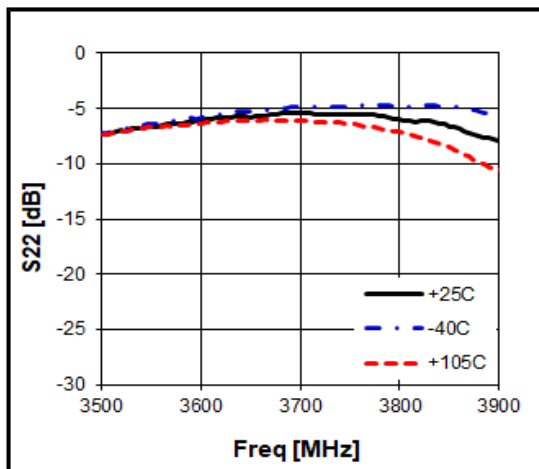
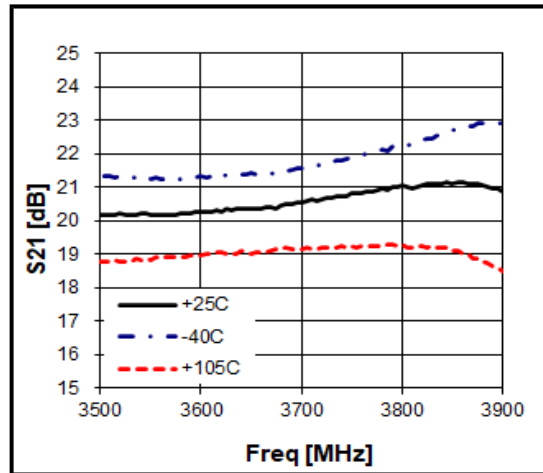
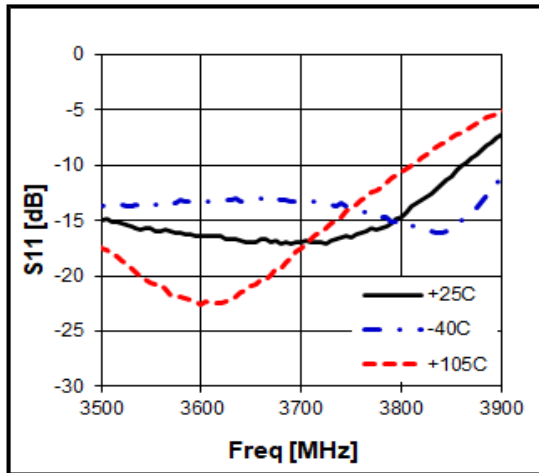

3GPP 5G NR 1FA ACLR 3.7GHz

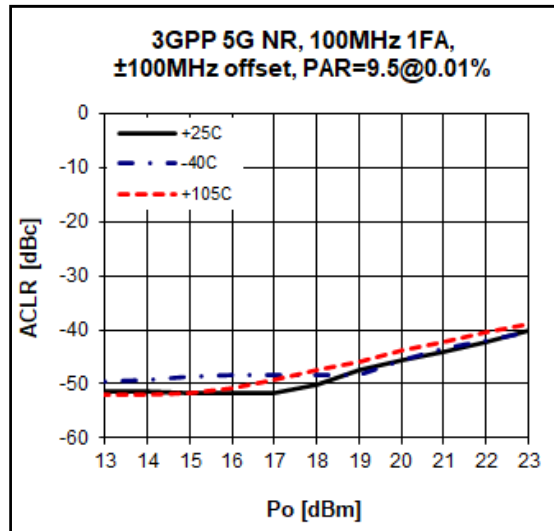

3GPP 5G NR 1FA ACLR (-50dBc)

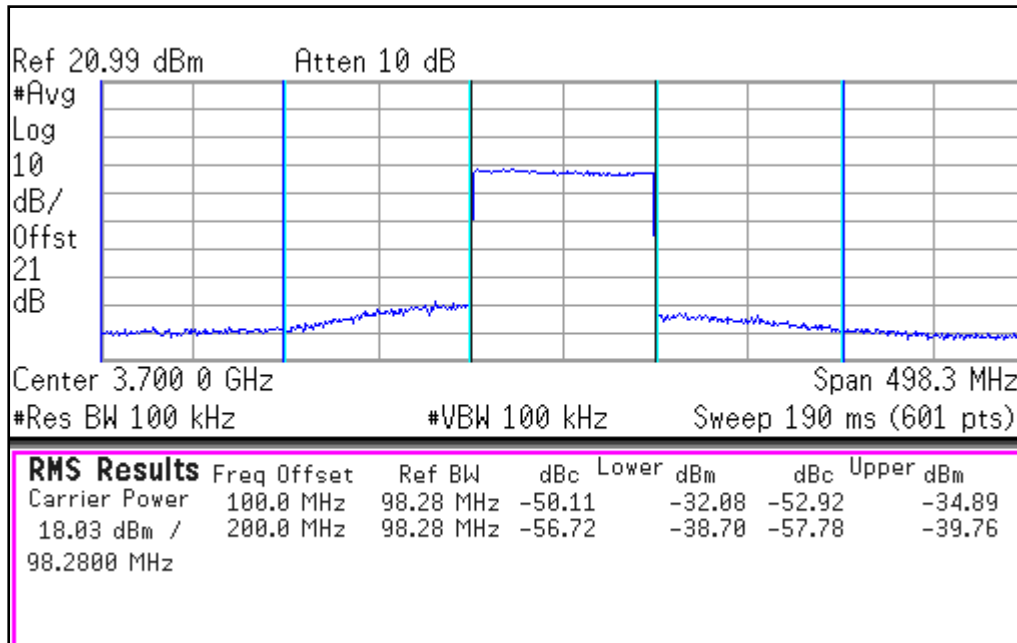

Application Circuit: 3800 MHz

Schematic Diagram	BOM	Marks	
	C1	0603 1uF	
	C2	0603 1uF	
	C3	0603 20pF	
	C4	0603 20pF	
	C5	0603 N/A	
	C6	0603 N/A	
	C7	0603 20pF	
	C8	0603 10pF	High Q Cap
	C9	0603 N/A	
	C10	0603 N/A	
	C11	0603 N/A	
	C12	0603 N/A	
	C13	0603 2pF	
	C14	0603 20pF	
	C15	0603 1uF	
	C16	0603 0.8pF	High Q Cap
	C17	0603 1.3pF	High Q Cap
	C18	0603 1.2pF	High Q Cap
	C19	0603 0.2pF	High Q Cap
L1	0603 0 Ω		
L2	0805 12nH	Coilcraft-HQ	
R1	0603 330 Ω		
R2	0603 470 Ω		
R3	0603 20 Ω		

PCB Diagram	Notice															
	<p>In table below can be changed per substrate conditions</p> <table border="1"> <thead> <tr> <th>Reference</th> <th>Object</th> <th>Distance</th> </tr> </thead> <tbody> <tr> <td>Input pin</td> <td>C17</td> <td>8.0mm</td> </tr> <tr> <td>Input pin</td> <td>C16</td> <td>1.5mm</td> </tr> <tr> <td>Output pin</td> <td>C18</td> <td>1.2mm</td> </tr> <tr> <td>Output pin</td> <td>C19</td> <td>2.0mm</td> </tr> </tbody> </table>	Reference	Object	Distance	Input pin	C17	8.0mm	Input pin	C16	1.5mm	Output pin	C18	1.2mm	Output pin	C19	2.0mm
	Reference	Object	Distance													
Input pin	C17	8.0mm														
Input pin	C16	1.5mm														
Output pin	C18	1.2mm														
Output pin	C19	2.0mm														
<p>3.8GHz_BMT352 Application Circuit QFN3x3_12L PKG Type 1.5W 2Stage_0.4T Ver4.2 PCB=FR-4, Oz=L0 Er=4.6, RF width=0.64mm, Clearance=0.4mm, HEIGHT=0.4T BEREX_161220</p>	<p>1. C8 & C17 & C16 & C18 & C19 : We recommend High-Q capacitor for better output power performance. We used Johanson Tech's capacitor .</p>															

Typical Performance

(V_{CC} & $V_{Bias} = +5V$, $I_{CQ} = 330mA$, $T_a = 25\text{ }^\circ C$)

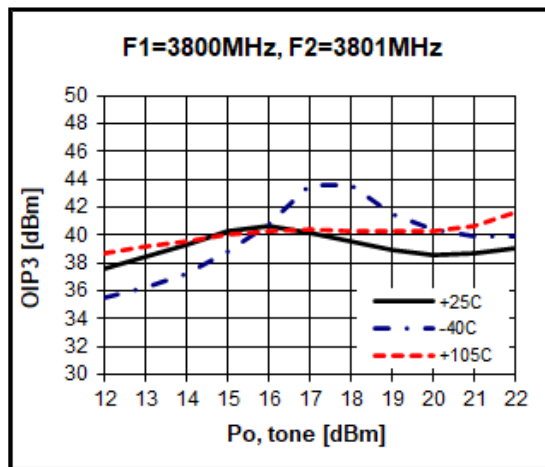
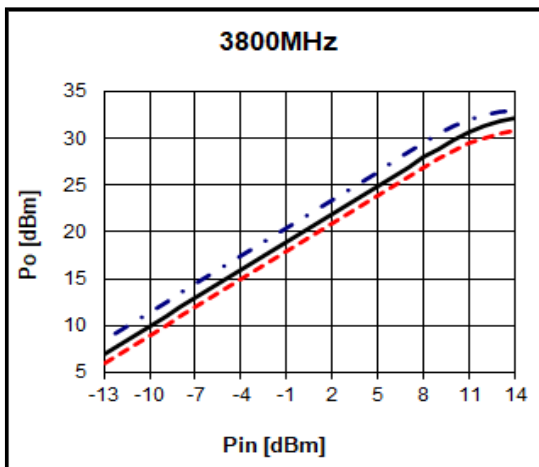
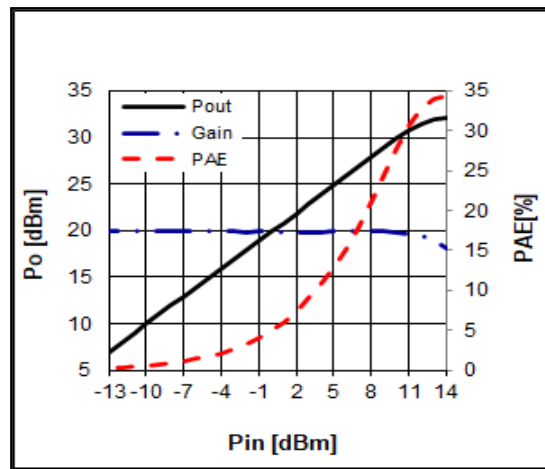
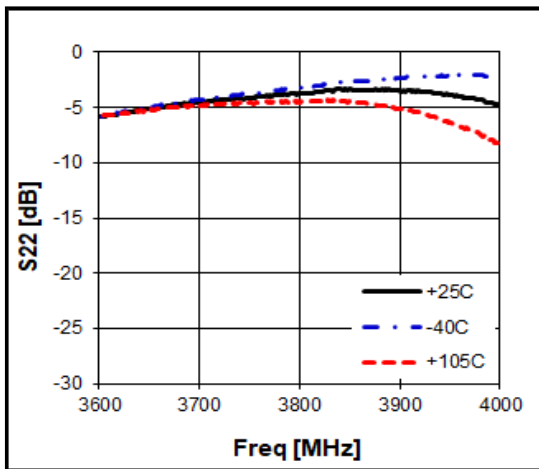
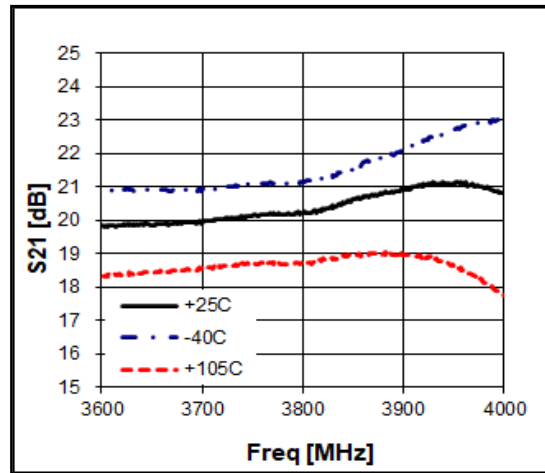
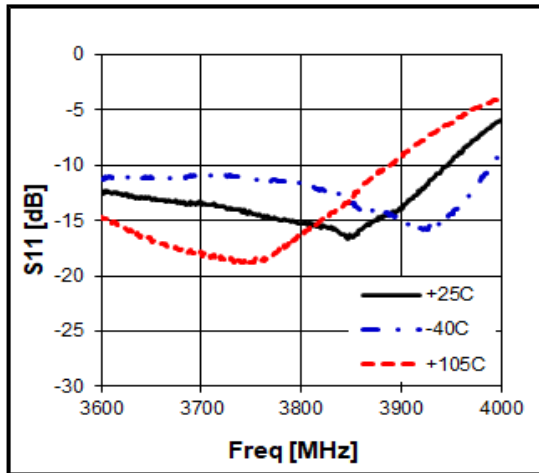

3GPP 5G NR 1FA ACLR 3.8GHz

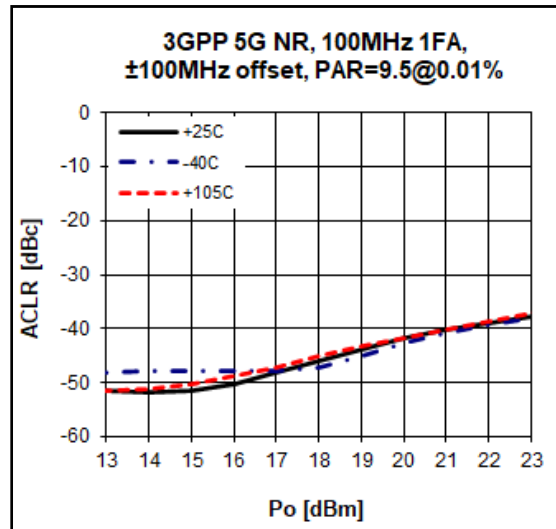

3GPP 5G NR 1FA ACLR (-50dBc)

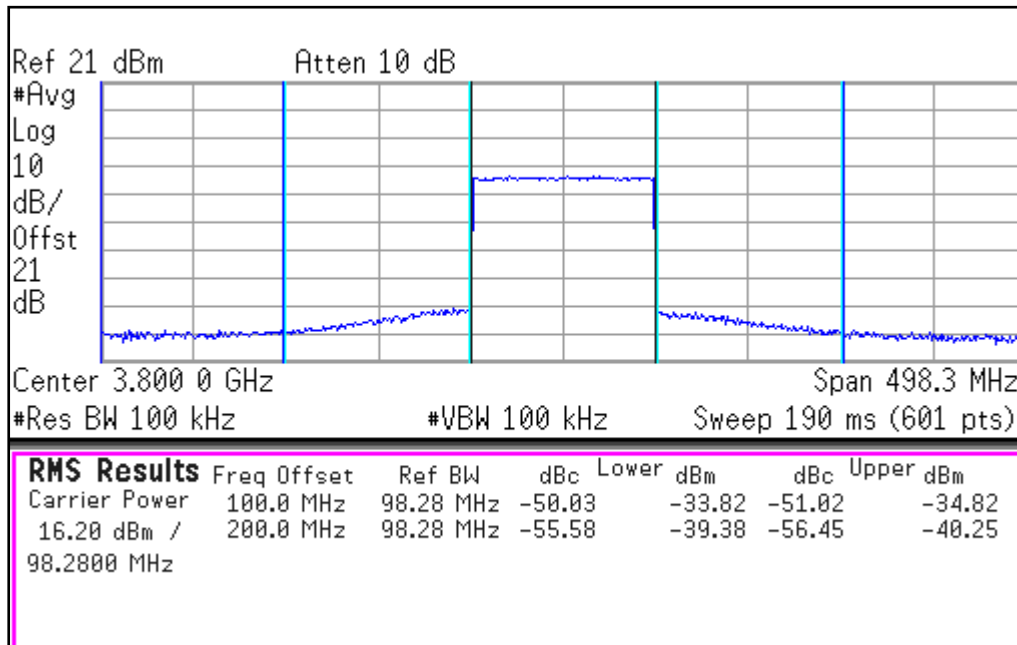

Package Outline Dimension

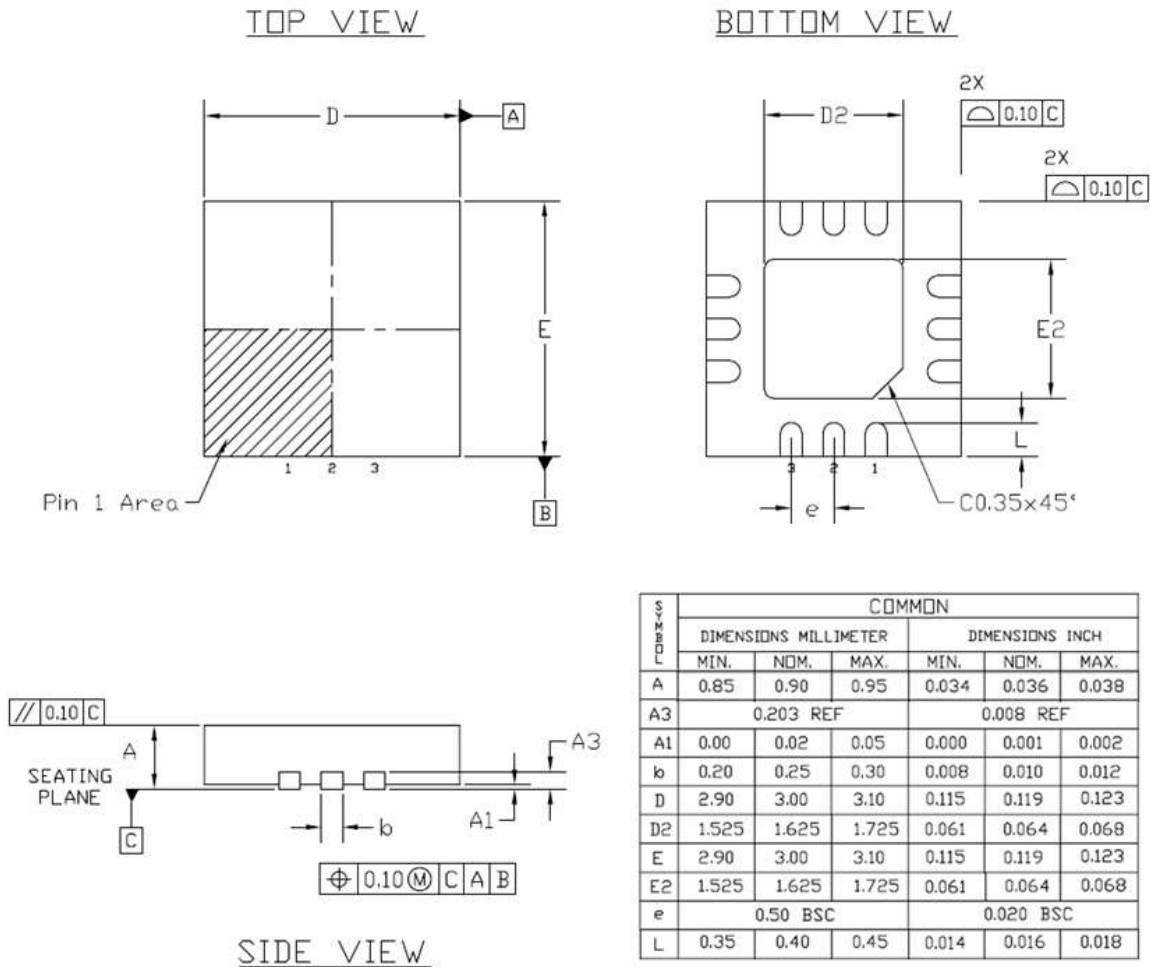

NOTES :

1. DIMENSION AND TOLERANCING CONFORM TO ASME Y14.5M-1994.
2. CONTROLLING DIMENSIONS : MILLIMETER. CONVERTED INCH DIMENSION ARE NOT NECESSARILY EXACT.
3. DIMENSION b APPLIES TO METALLIZED TERMINAL AND IS MEASURED BETWEEN 0.15 AND 0.30 MM. FROM TERMINAL TIP.
4. INSULATION THICKNESS, CLEARANCE OF OVERLAP ARE USER DEFINED.
5. INSULATION NOT COMPLETELY SHOWN FOR REASONS OF CLARITY.

Suggested PCB Land Pattern and PAD Layout

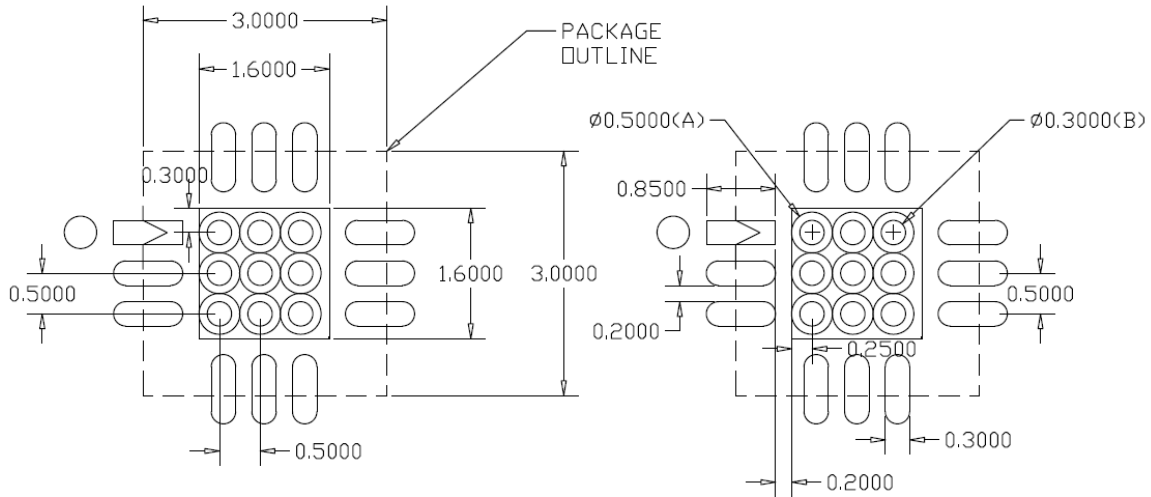

Unit : mm

• Notes

1. Use 1 oz. copper minimum for top and bottom layer metal.
2. A heatsink underneath the area of the PCB for the mounted device is required for proper thermal operation.
3. Ground / thermal vias are critical for the proper performance of this device.

Package Marking



YY = Year, WW = Working Week,
XX = Wafer No.

PCB Mounting

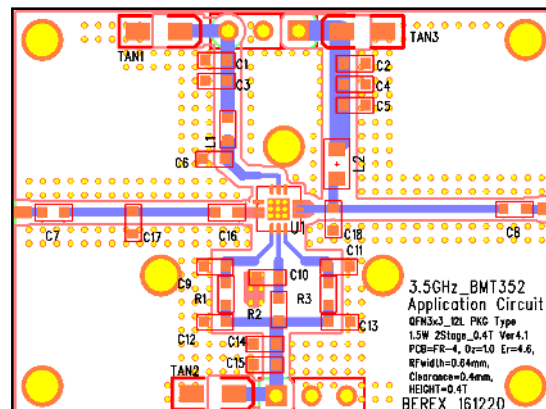

Tape & Reel

QFN 3x3

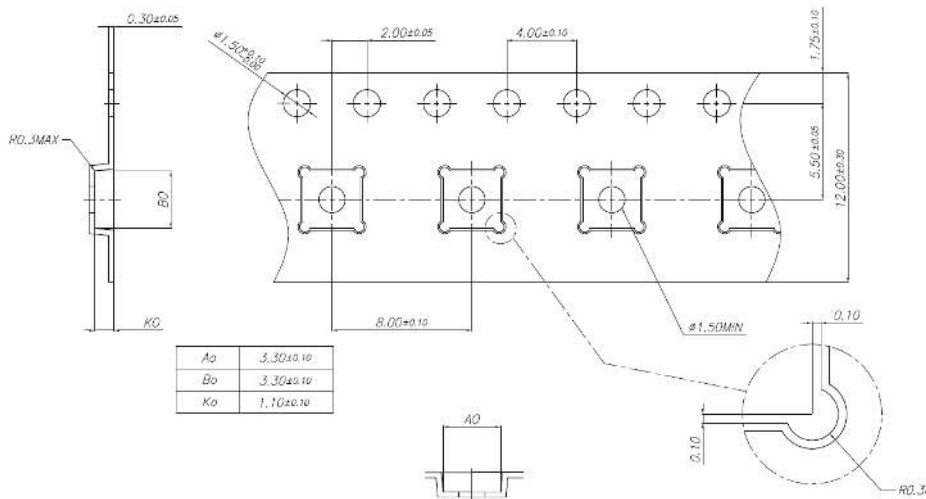

Packaging information :

Tape width(mm) : 12

Reel Size (inches) : 7

Device Cavity Pitch(mm) : 8

Devices Per Reel : 1000

Lead plating finish

100% Tin Matte finish

(All BeRex products undergoes a 1 hour, 150 degree C, Anneal bake to eliminate thin whisker growth concerns.)

MSL / ESD Rating

ESD Rating:	Class 1C
Value:	Passes $\geq 1000V$ to $< 2000 V$
Test:	Human Body Model (HBM)
Standard:	JEDEC Standard JS-001-2014
ESD Rating:	Class C3
Value:	Passes $>1000V$
Test:	Charged Device Model (CDM)
Standard:	JEDEC Standard JESD22-C101F
MSL Rating:	Level 1 at $+260^{\circ}C$ convection reflow
Standard:	JEDEC Standard J-STD-020



Proper ESD procedures should be followed when handling this device.

RoHS Compliance

This part is compliant with Restrictions on the Use of Certain Hazardous Substances in Electrical and Electronic Equipment (RoHS) Directive 2011/65/EU as amended by Directive 2015/863/EU.

This product also is compliant with a concentration of the Substances of Very High Concern (SVHC) candidate list which are contained in a quantity of less than 0.1%(w/w) in each components of a product and/or its packaging placed on the European Community market by the BeRex and Suppliers.

NATO CAGE code:

2	N	9	6	F
---	---	---	---	---