



Photocoupler
Product Data Sheet
LTV-M501

Spec No. :DS70-2013-0019
Effective Date: 01/10/2019
Revision: C

LITE-ON DCC

RELEASE

BNS-OD-FC001/A4

Photocoupler LTV-M501 series

Small Outline, 5Lead, High Speed Optocouplers

1. DESCRIPTION

The LTV-M501 series consists of a high efficient AlGaAs Light Emitting Diode and a high speed optical detector. This unique design provides excellent AC and DC isolation between the input and output sides of the Optocoupler. Connection for the bias of the photodiode improves the speed that of a conventional phototransistor coupler by reducing the base-collector capacitances. The internal shield ensures high common mode transient immunity. A guaranteed common mode transient immunity is up to 15kV/μs (Min.).

1.1 Features

- Surface mountable
- High speed – 1MBd typical
- Compatible with infrared vapor phase reflow and wave soldering process
- Very high common mode transient immunity: 15 kV/μs at $V_{CM} = 1500$ V guaranteed
- TTL compatible
- Open collector output
- Lead free option
- MSL Level 1
- Worldwide Safety approval :
UL/ cUL 1577, Cert. No.E113898.
3750 Vrms/1 min
VDE DIN EN60747-5-5, Cert. No. 138213
 $V_{IORM} = 560 V_{peak}$

1.2 Applications

- Ground loop elimination
- Feedback Element in Switching Mode Power Supplier
- High Speed Logic Ground Isolation – TTL/TTL, TTL/LTTL, TTL/CMOS, TTL/LSTTL
- Pulse transformer replacement: save board space and weight
- Analog signal ground isolation: Integrated photon detector provides improved linearity over phototransistor type.

Functional Diagram

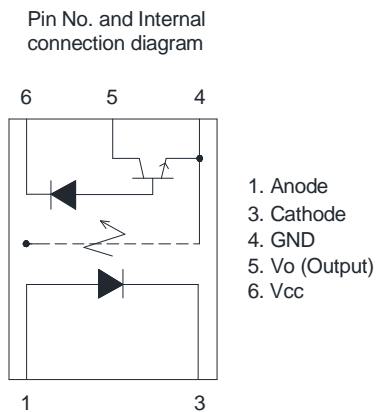

Truth Table (Positive Logic)

LED	OUT
ON	L
OFF	H

A 0.1μF bypass Capacitor must be connected between Pin4 and Pin6

Photocoupler LTV-M501 series

2. PACKAGE DIMENSIONS

2.1 LTV-M501 series

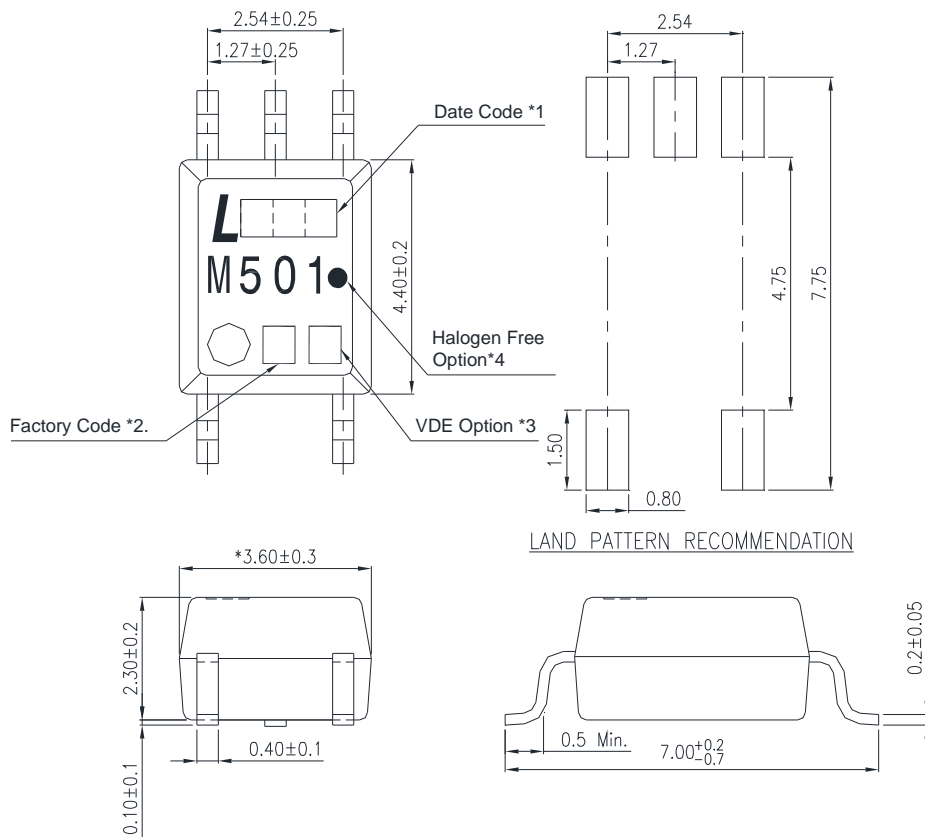

Notes :

1. The first digit is year date code, second and third digit is work week
2. Factory identification mark (W :China-CZ)
3. VDE option
4. Halogen free option

* Dimensions are in Millimeters and (Inches).

* Mold flash on each side is 0.15mm maximum

Photocoupler LTV-M501 series

3. TAPING DIMENSIONS

3.1 LTV-M501

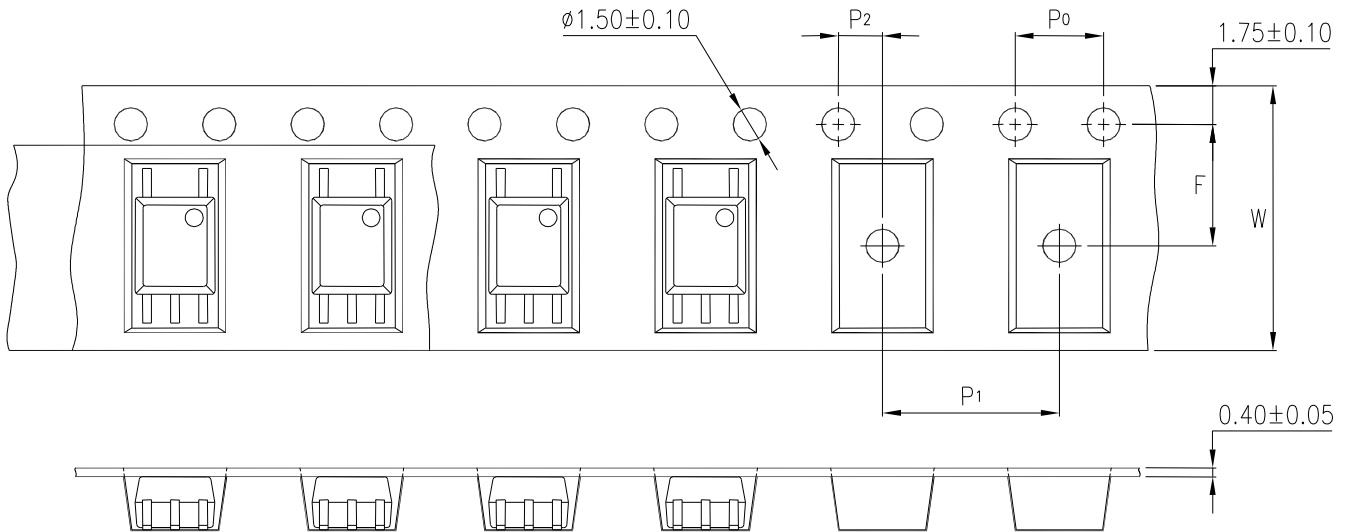

Description	Symbol	Dimension in mm (inch)
Tape wide	W	12 ± 0.3 (.472)
Pitch of sprocket holes	P ₀	4 ± 0.1 (.157)
Distance of compartment	F	5.5 ± 0.1 (.217)
	P ₂	2 ± 0.1 (.079)
Distance of compartment to compartment	P ₁	8 ± 0.1 (.315)

3.3 Quantities Per Reel

Package Type	LTV-M501 series
Quantities (pcs)	3000

Photocoupler LTV-M501 series

4. RATING AND CHARACTERISTICS

4.1 Absolute Maximum Ratings at Ta=25°C *

Parameter	Symbol	Min	Max	Units	Note
Storage Temperature	T _{ST}	-55	125	°C	
Operating Temperature	T _A	-55	100	°C	
Isolation Voltage	V _{ISO}	3750		V _{RMS}	
Supply Voltage	V _{CC}	-0.5	30	V	
Lead Solder Temperature **			260	°C	
Input					
Average Forward Input Current	I _F		25	mA	
Peak Input Current (50% duty cycle, 1 ms pulse width)	I _F		50	mA	
Peak Transient Input Current (1 μs pulse width, 300 pps)	I _F		1.0	A	
Reverse Input Voltage	V _R		5	V	
Input Power Dissipation	P _I		45	mW	
Output					
Output Collector Current	I _O		8	mA	
Peak Output Current	I _O		16	mA	
Output Collector Voltage	V _O	-0.5	20	V	
Output Collector Power Dissipation	P _O		100	mW	

*Ambient temperature = 25°C, unless otherwise specified. Stresses exceeding the absolute maximum ratings can cause permanent damage to the device. Exposure to absolute maximum ratings for long periods of time can adversely affect reliability.

**260°C for 10 seconds. Refer to Lead Free Reflow Profile.

Photocoupler LTV-M501 series

4.2 ELECTRICAL OPTICAL CHARACTERISTICS

Parameters	Test Condition	Symbol	Min	Typ	Max	Units	Fig.	Note
Input								
Input Forward Voltage	$I_F = 16\text{mA}$, $T_A = 25^\circ\text{C}$	V_F	1.2	1.4	1.8	V	2	
Input Reverse Voltage	$I_R = 10\mu\text{A}$	BV_R	5			V		
Detector								
Current transfer ratio	$I_F = 16\text{mA}$; $V_{CC} = 4.5\text{V}$; $T_A = 25^\circ\text{C}$; $V_O = 0.4\text{V}$	CTR	20	36	50	%	4,5	2
	$I_F = 16\text{mA}$; $V_{CC} = 4.5\text{V}$; $T_A = 25^\circ\text{C}$; $V_O = 0.5\text{V}$		15	38				
Logic low output voltage output voltage	$I_F = 16\text{mA}$; $V_{CC} = 4.5\text{V}$; $I_O = 3.0\text{mA}$; $T_A = 25^\circ\text{C}$	V_{OL}		0.2	0.4	V		
	$I_F = 16\text{mA}$; $V_{CC} = 4.5\text{V}$; $I_O = 2.4\text{mA}$; $T_A = 25^\circ\text{C}$				0.5			
Logic high output current	$I_F = 0\text{mA}$, $V_O = V_{CC} = 5.5\text{V}$, $T_A = 25^\circ\text{C}$	I_{OH}		0.002	0.5	μA	7	
	$I_F = 0\text{mA}$, $V_O = V_{CC} = 15\text{V}$ $T_A = 25^\circ\text{C}$			0.005	1			
	$T_A = 0 \sim 70^\circ\text{C}$				50			
Logic low supply current	$I_F = 16\text{mA}$, $V_O = \text{open}$ ($V_{CC} = 15\text{V}$)	I_{CCL}		185				1
Logic high supply current	$I_F = 0\text{mA}$, $V_O = \text{open}$; $T_A = 25^\circ\text{C}$ ($V_{CC} = 15\text{V}$)	I_{CCH}		0.002	1			1

*Over recommended temperature ($T_A = 0^\circ\text{C}$ to 70°C) unless otherwise specified.

*All Typical at $T_A = 25^\circ\text{C}$

Photocoupler LTV-M501 series

5. SWITCHING SPECIFICATION

Parameters	Test Condition	Symbol	Min	Typ	Max	Units	Fig.	Note
Propagation Delay Time to Low Output Level	$T_A = 25^\circ\text{C}$	t_{PHL}		190	800	ns	3.6,9	3, 4
	0 ~ 100°C				800			
Propagation Delay Time to High Output Level	$T_A = 25^\circ\text{C}$	t_{PLH}		150	800	ns	3.6,9	3, 4
	0 ~ 100°C				800			
Logic High Common Mode Transient Immunity	$I_F = 0\text{mA}; V_{\text{CM}} = 1500\text{Vp-p};$ $C_L = 15\text{ pF}; T_A = 25^\circ\text{C},$ $R_L = 1.9\text{K}\Omega$	$ CM_H $	15			kV/ μs	10	3, 4
Logic Low Common Mode Transient Immunity	$I_F = 16\text{mA}; V_{\text{CM}} = 1500\text{Vp-p}$ $C_L = 15\text{ pF}; T_A = 25^\circ\text{C},$ $R_L = 1.9\text{K}\Omega$	$ CM_L $	15			kV/ μs	10	3, 4

*Over recommended temperature ($T_A = 0^\circ\text{C}$ to 70°C) $V_{\text{CC}} = 5\text{ V}$, $I_F = 16\text{mA}$ unless otherwise specified.

*All Typical at $T_A = 25^\circ\text{C}$

Photocoupler LTV-M501 series

6. ISOLATION CHARACTERISTIC

Parameter	Symbol	Min.	Typ.	Max.	Unit	Test Condition	Note
Input-Output Insulation Leakage Current	I_{I-O}	—	—	1.0	μA	45% RH, $t = 5s$, $V_{I-O} = 3kV DC$, $T_A = 25^\circ C$	5
Withstand Insulation Test Voltage	V_{ISO}	3750	—	—	V_{RMS}	RH $\leq 50\%$, $t = 1min$, $T_A = 25^\circ C$	5, 6
Input-Output Resistance	R_{I-O}	—	10^{12}	—	Ω	$V_{I-O} = 500V DC$	5

Typical values applies to $T_A = 25^\circ C$

Note

1. Use of a 0.1 μf bypass capacitor connected between pins 4 and 6 is recommended.
2. Current Transfer Ratio is defined as the ratio of output collector current I_o , to the forward LED input current I_F , times 100.
3. The 1.9K Ω load represents 1TTL unit load of 1.6mA and the 5.6K Ω pull-up resistor.
4. The 4.1K Ω load represents 1LSTTL unit load of 0.36mA and the 6.1K Ω pull-up resistor.
5. Device considered a two-terminal device: Pins 1 and 3 shorted together and Pins 4, 5 and 6 shorted together.
6. In accordance with UL1577, each optocoupler is proof tested by applying an insulation test voltage 4500Vrms for one second (leakage current less than 10 μA). This test is performed before the 100% production test for partial discharge

Photocoupler LTV-M501 series

7. TYPICAL PERFORMANCE CURVES

Figure 1: DC and Pulsed Transfer Characteristics.

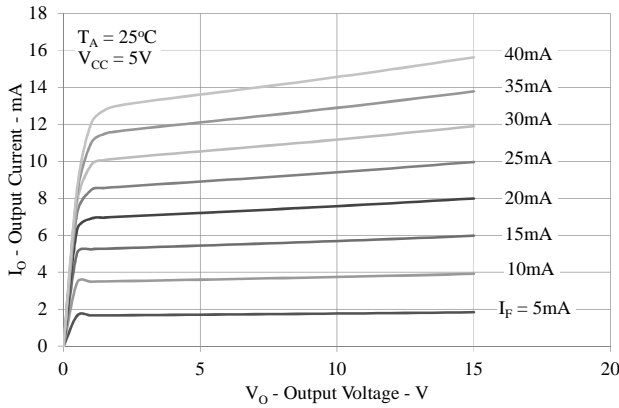

Figure 2: Current Transfer Ratio vs. Input Current.

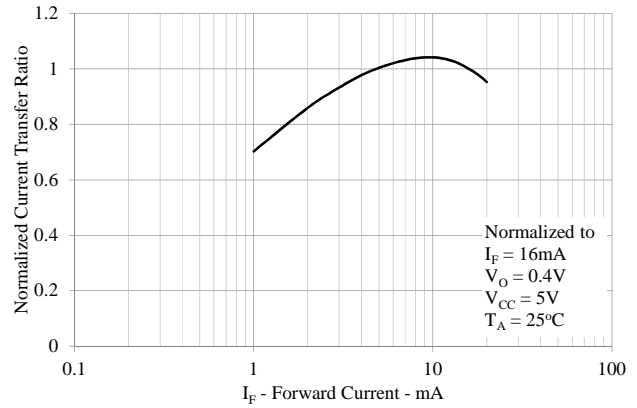

Figure 3: Input Current vs. Forward Voltage.

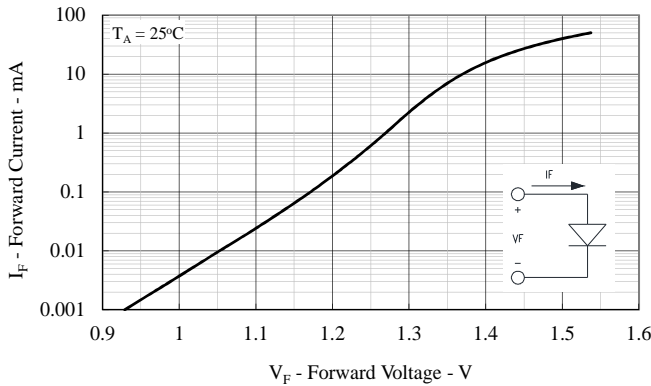

Figure 4: Current Transfer Ratio vs. Temperature.

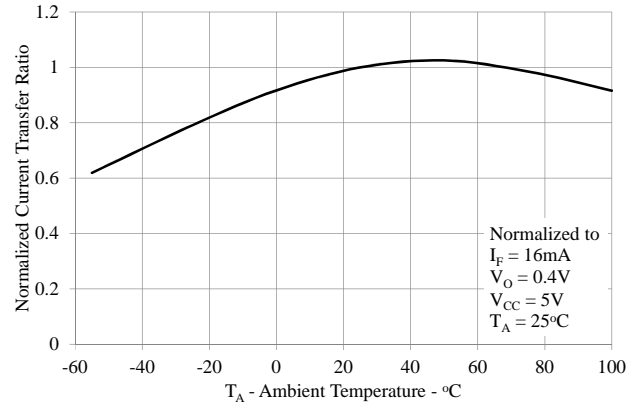

Figure 5: Propagation Delay vs. Load Resistance.

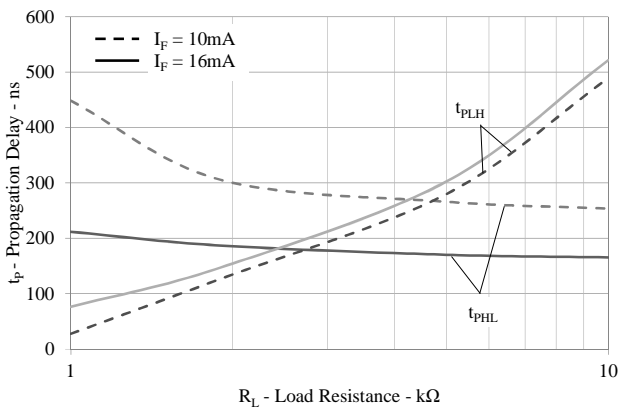
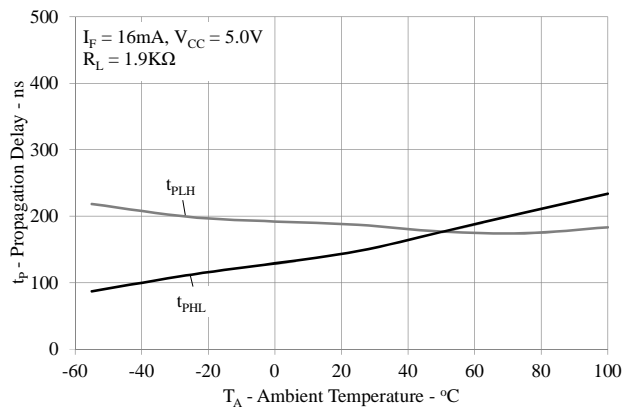

Figure 6: Propagation Delay Time vs. Temperature.



Photocoupler LTV-M501 series

Figure 7: Logic High Output Current vs. Temperature.

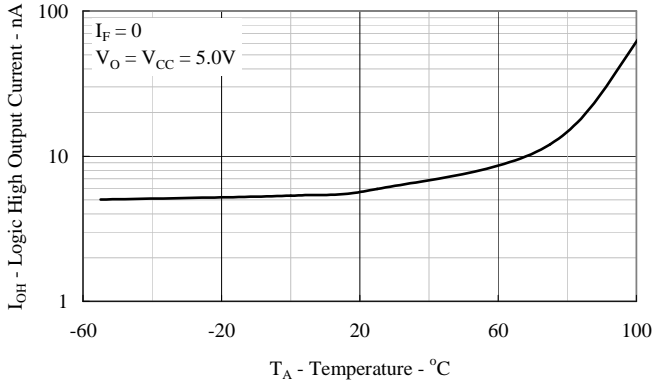

Figure 8: Frequency Response.

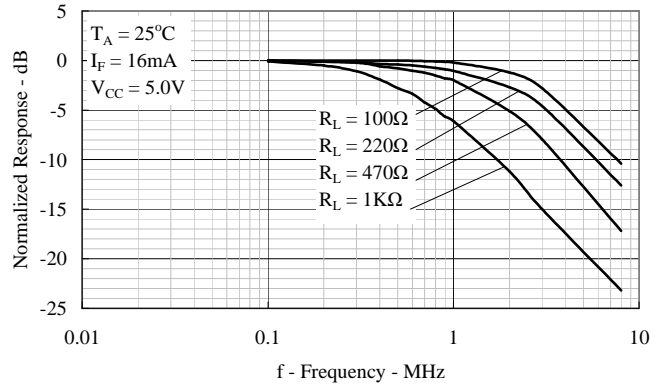

Figure 9: Switching Test Circuit.

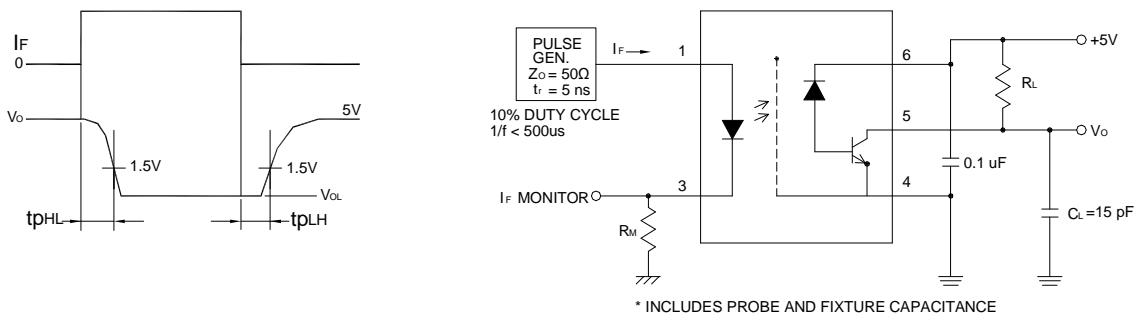
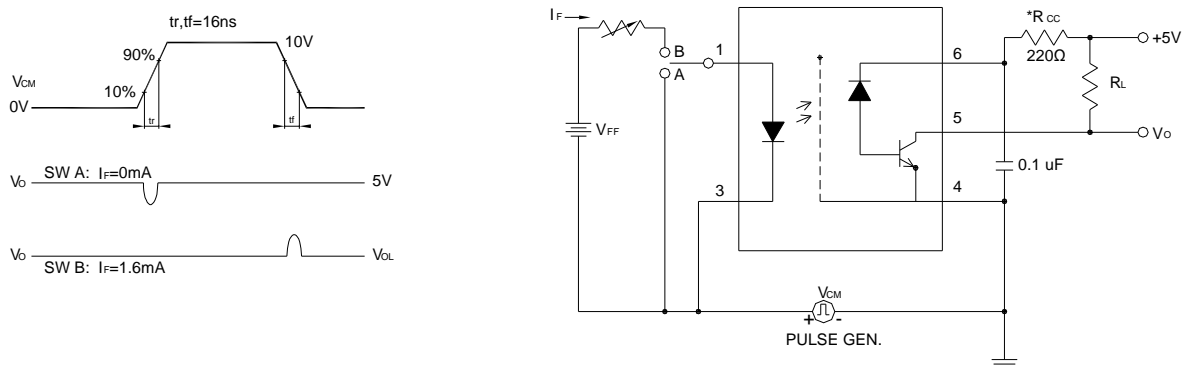

Figure 10: Test Circuit for Transient Immunity and Typical Waveforms.



Photocoupler LTV-M501 series

8. TEMPERATURE PROFILE OF SOLDERING

8.1 IR Reflow soldering (JEDEC-STD-020C compliant)

One time soldering reflow is recommended within the condition of temperature and time profile shown below. Do not solder more than three times.

Profile item	Conditions
Preheat	
- Temperature Min (T_{Smin})	150°C
- Temperature Max (T_{Smax})	200°C
- Time (min to max) (ts)	90±30 sec
Soldering zone	
- Temperature (T_L)	217°C
- Time (t_L)	60 ~ 100sec
Peak Temperature (T_P)	260°C
Ramp-up rate	3°C / sec max.
Ramp-down rate	3~6°C / sec

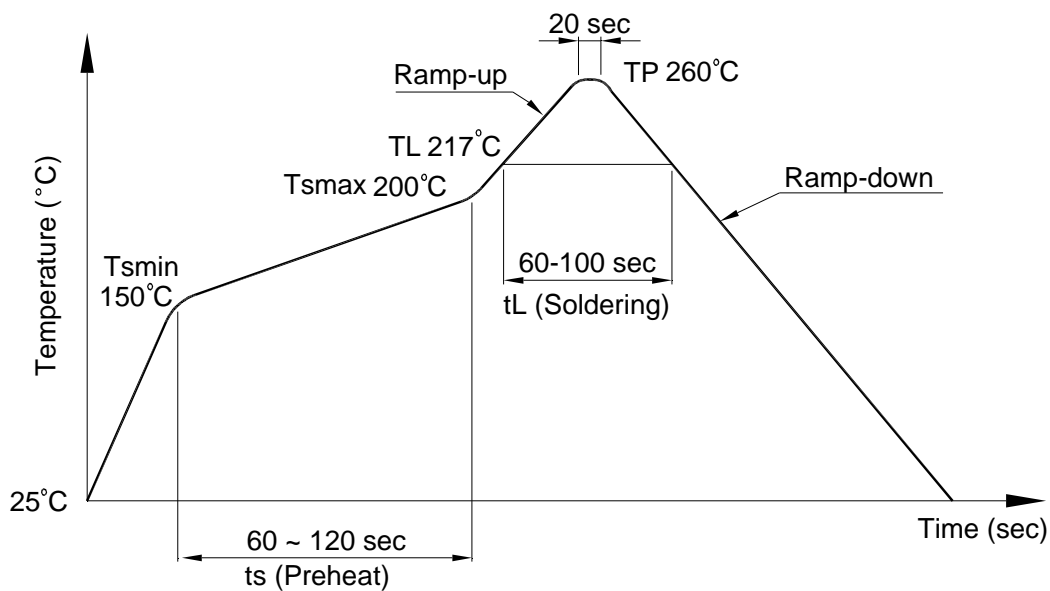

Photocoupler LTV-M501 series

8.2 Wave soldering (JEDEC22A111 compliant)

One time soldering is recommended within the condition of temperature.

Temperature: $260 \pm 0 / -5^{\circ}\text{C}$

Time: 10 sec.

Preheat temperature: 25 to 140°C

Preheat time: 30 to 80 sec.

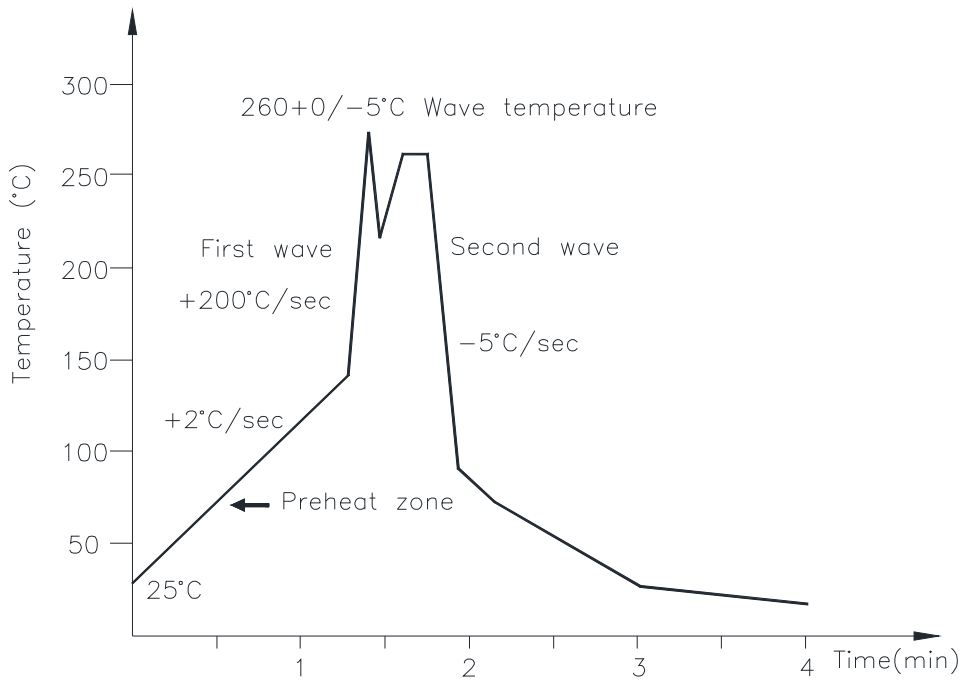

8.3 Hand soldering by soldering iron

Allow single lead soldering in every single process. One time soldering is recommended.

Temperature: $380 \pm 0 / -5^{\circ}\text{C}$

Time: 3 sec max.

**Photocoupler
LTV-M501 series**

9. NAMING RULE

Part Number Options
LTV-M501
LTV-M501-G
LTVM501-V-G

Definition of Suffix	Remark
"M501"	LiteOn model name
"no suffix"	Pin 1 location at upper right of the tape
"V"	VDE approved option
"G"	Halogen free option

10. NOTES

LiteOn is continually improving the quality, reliability, function or design and LiteOn reserves the right to make changes without further notices.

The products shown in this publication are designed for the general use in electronic applications such as office automation equipment, communications devices, audio/visual equipment, electrical application and instrumentation.

For equipment/devices where high reliability or safety is required, such as space applications, nuclear power control equipment, medical equipment, etc, please contact our sales representatives.

When requiring a device for any "specific" application, please contact our sales in advice.

If there are any questions about the contents of this publication, please contact us at your convenience.

The contents described herein are subject to change without prior notice.

Immerge unit's body in solder paste is not recommended.