

## FEATURES

**Gain: 13 dB typical**  
**High 1 dB compression (P1dB) output power: 29 dBm typical**  
**High output third-order intercept (IP3): 40 dBm typical**  
**Regulated supply and bias sequencing**  
**Subminiature Version A (SMA) connectors**  
**Operating temperature range:  $-40^{\circ}\text{C}$  to  $+70^{\circ}\text{C}$**

## APPLICATIONS

**Telecom infrastructure**  
**Test instrumentation**  
**Military and space**  
**Electronic warfare (EW)**  
**Electronic countermeasures (ECM)**  
**Radars**  
**Test equipment**

## GENERAL DESCRIPTION

The [HMC-C074](#) is a single stage power amplifier that operates between 10 MHz and 6 GHz. The amplifier provides 13 dB of gain, 40 dBm output IP3, and 29 dBm of output power at 1 dB gain compression while only consuming 450 mA from a 15 V supply.

The  $\pm 0.75$  dB gain flatness is excellent from 10 MHz to 6 GHz, making the [HMC-C074](#) ideal for EW, ECM, radar, and test equipment applications.

## FUNCTIONAL BLOCK DIAGRAM

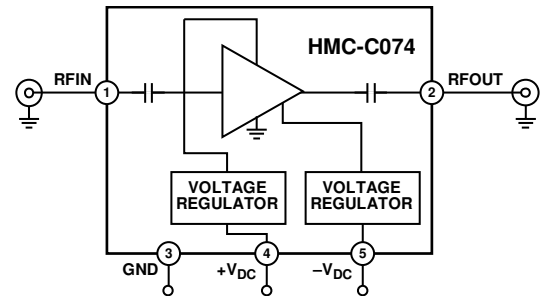

Figure 1.

14614-001

The amplifier inputs/outputs are dc blocked and internally matched to 50  $\Omega$ . Integrated voltage regulators allow for flexible biasing of both the negative and positive supply pins, while internal bias sequencing and active bias control allows for robust operation and stable performance over temperature.

**TABLE OF CONTENTS**

Features ..... 1  
Applications..... 1  
Functional Block Diagram ..... 1  
General Description ..... 1  
Revision History ..... 2  
Specifications..... 3  
Absolute Maximum Ratings..... 4  
    ESD Caution..... 4

Pin Configuration and Function Descriptions.....5  
Typical Performance Characteristics .....6  
Theory of Operation .....8  
Applications Information .....9  
Outline Dimensions ..... 10  
    Ordering Guide ..... 10

**REVISION HISTORY**

**8/2016—v02.0711 to Rev. C**

This Hittite Microwave Products data sheet has been reformatted to meet the styles and standards of Analog Devices, Inc.  
Updated Format..... Universal  
Changes to Specifications and Table 1 ..... 3  
Changes to Table 2..... 4

Changes to Figure 3 to Figure 8.....6  
Changes to Figure 9 to Figure 14.....7  
Added Theory of Operation Section .....8  
Added Applications Information Section .....9

## SPECIFICATIONS

Bias voltages = +15 V and -5 V, and baseplate temperature = 25°C, unless otherwise noted.

Table 1.

Parameter	Min	Typ	Max	Unit	Test Conditions/Comments
FREQUENCY RANGE	0.01		6	GHz	
GAIN	11	13		dB	
Gain Flatness		±0.75		dB	
Gain Variation over Temperature		0.02		dB/°C	
NOISE FIGURE		5		dB	
1 dB COMPRESSION (P1dB)					
0.01 GHz to 1 GHz	24	29		dBm	
1 GHz to 3 GHz	26	29		dBm	
3 GHz to 6 GHz	24	28		dBm	
OUTPUT THIRD-ORDER INTERCEPT (IP3)					
0.01 GHz to 1 GHz		35		dBm	
1 GHz to 3 GHz		40		dBm	
3 GHz to 6 GHz		40		dBm	
OUTPUT SATURATED POWER (P <sub>SAT</sub> )		29		dBm	
RETURN LOSS					
Input		-15		dB	
Output		-17		dB	
SUPPLY INPUT					
+V <sub>DC</sub>		+15		V	
-V <sub>DC</sub>		-5		V	
CURRENT					
+V <sub>DC</sub>		475	575	mA	+V <sub>DC</sub> = +15 V, -V <sub>DC</sub> = -5 V
-V <sub>DC</sub>		4	20	mA	

## ABSOLUTE MAXIMUM RATINGS

Table 2.

Parameter	Rating
Positive (15 V) Bias Supply (+V <sub>DC</sub> )	16 V
Negative (-5 V) Bias Supply (-V <sub>DC</sub> )	-16 V
Radio Frequency (RF) Input (RFIN) Power	25 dBm
Operating Temperature Range	-40°C to +70°C
Storage Temperature Range	-55°C to +150°C
ESD Sensitivity, Human Body Model (HBM)	Class IA

Stresses at or above those listed under Absolute Maximum Ratings may cause permanent damage to the product. This is a stress rating only; functional operation of the product at these or any other conditions above those indicated in the operational section of this specification is not implied. Operation beyond the maximum operating conditions for extended periods may affect product reliability.

### ESD CAUTION



**ESD (electrostatic discharge) sensitive device.** Charged devices and circuit boards can discharge without detection. Although this product features patented or proprietary protection circuitry, damage may occur on devices subjected to high energy ESD. Therefore, proper ESD precautions should be taken to avoid performance degradation or loss of functionality.

## PIN CONFIGURATION AND FUNCTION DESCRIPTIONS

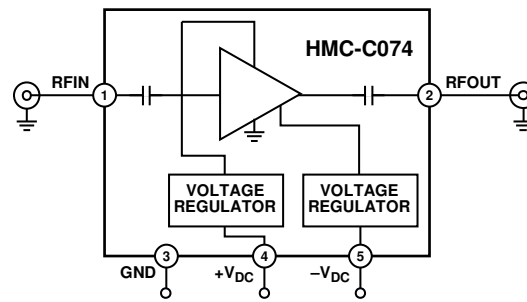

Figure 2. Pin Configuration

14614-002

Table 3. Pin Function Descriptions

Pin No.	Mnemonic	Description
1	RFIN	RF Input Connector, SMA Female. This pin is ac-coupled and matched to 50 $\Omega$ .
2	RFOUT	RF Output Connector, SMA Female. This pin is ac-coupled and matched to 50 $\Omega$ .
3	GND	Power Supply Ground.
4	+V <sub>DC</sub>	Positive Supply Voltage for the Amplifier, 14 V to 16 V.
5	-V <sub>DC</sub>	Negative Supply Voltage for the Amplifier, -5 V to -16 V.

# TYPICAL PERFORMANCE CHARACTERISTICS

Bias voltages = +15 V and -5 V, and the baseplate temperature = 25°C, unless otherwise noted.

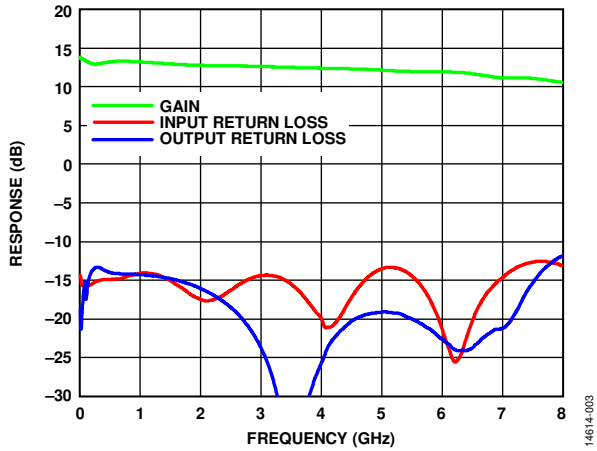

Figure 3. Response (Gain, Input Return Loss, and Output Return Loss) vs. Frequency (Linear Scale)

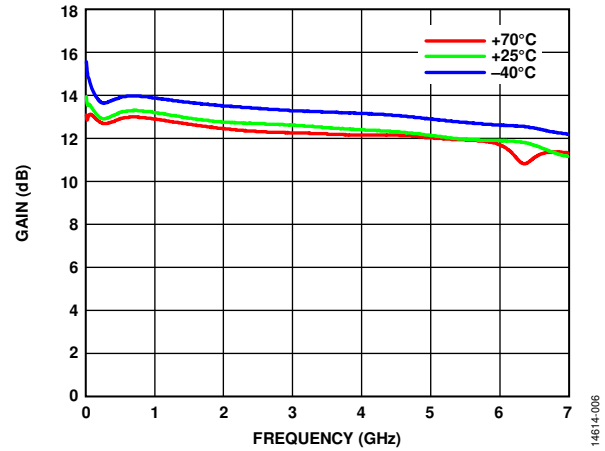

Figure 6. Gain vs. Frequency for Various Temperatures (Linear Scale)

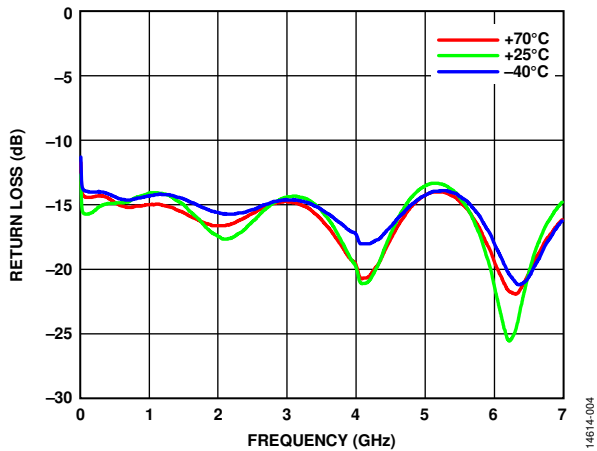

Figure 4. Input Return Loss vs. Frequency for Various Temperatures (Linear Scale)

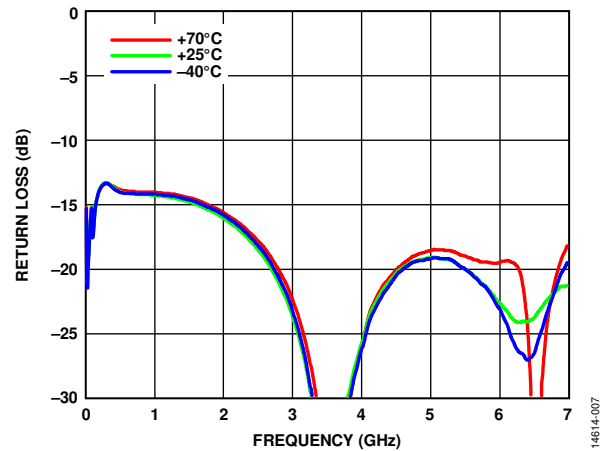

Figure 7. Output Return Loss vs. Frequency for Various Temperatures (Linear Scale)

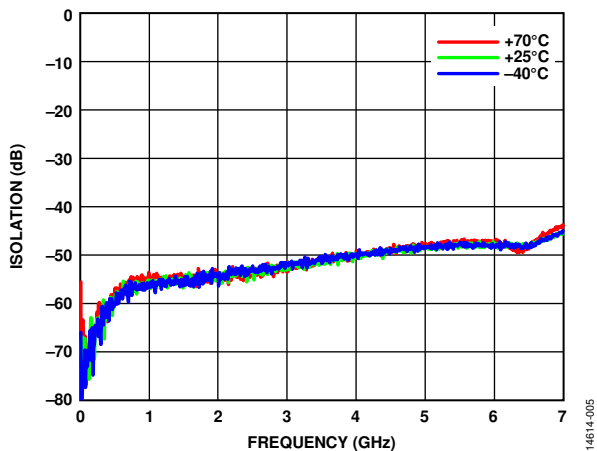

Figure 5. Isolation vs. Frequency for Various Temperatures (Linear Scale)

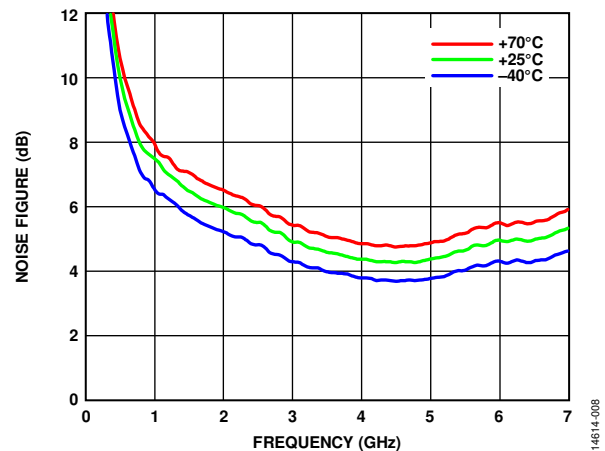

Figure 8. Noise Figure vs. Frequency for Various Temperatures (Linear Scale)

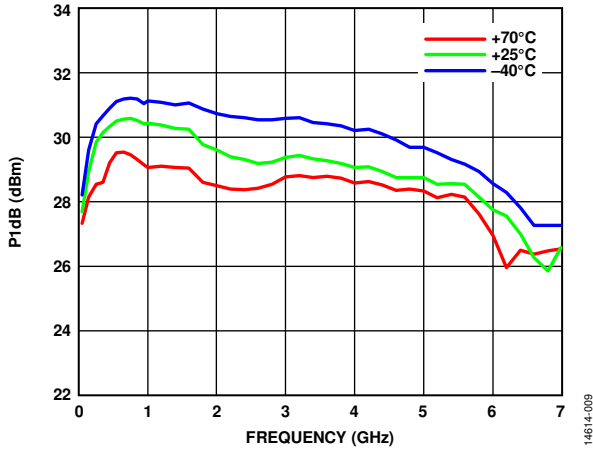

Figure 9. Output P1dB vs. Frequency for Various Temperatures (Linear Scale)

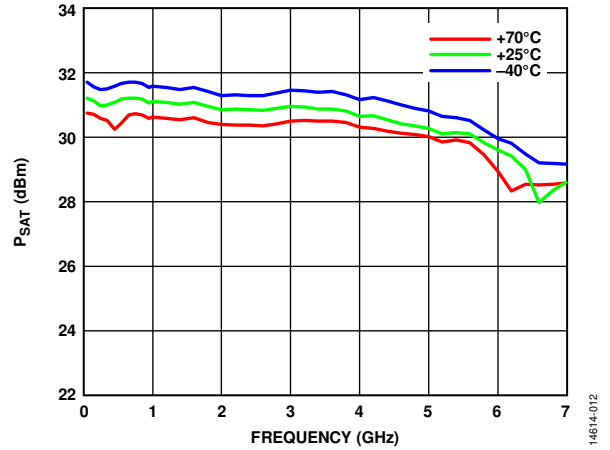

Figure 12.  $P_{SAT}$  vs. Frequency for Various Temperatures (Linear Scale)

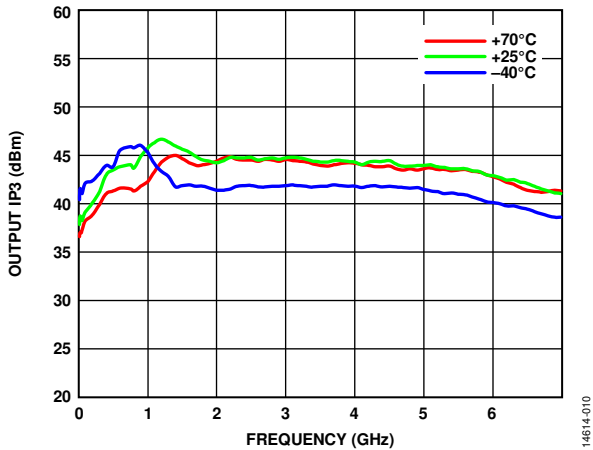

Figure 10. Output IP3 vs. Frequency for Various Temperatures (Linear Scale)

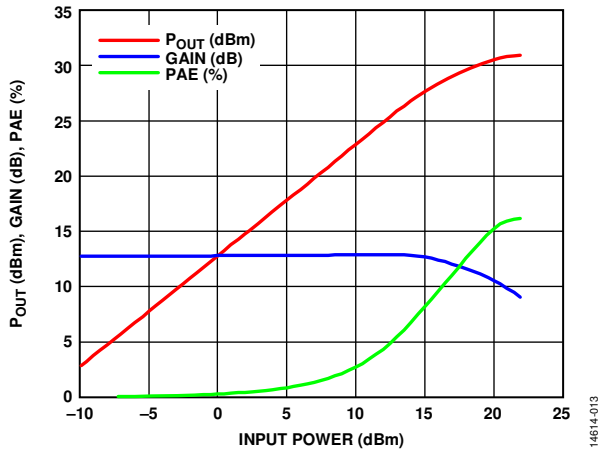

Figure 13. Output Power ( $P_{OUT}$ ), Gain, and Power Added Efficiency (PAE) vs. Input Power (Linear Scale)

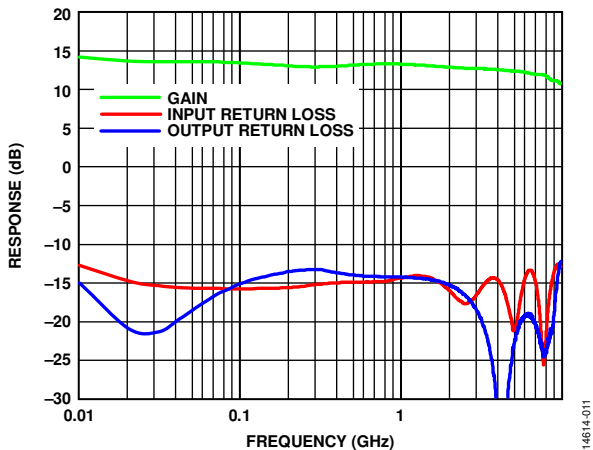

Figure 11. Response (Gain, Input Return Loss, and Output Return Loss) vs. Frequency (Log Scale)

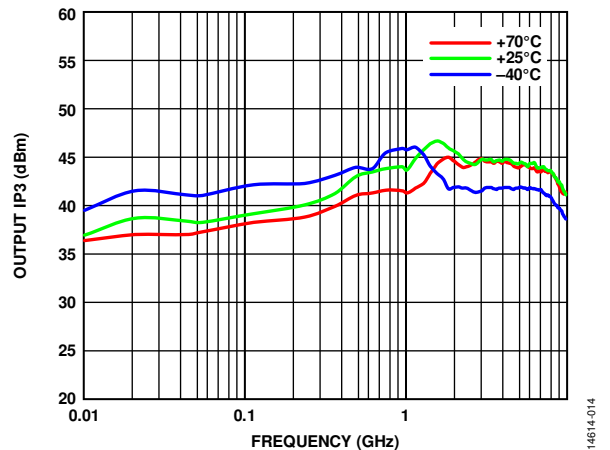

Figure 14. Output IP3 vs. Frequency for Various Temperatures (Log Scale)

## THEORY OF OPERATION

The [HMC-C074](#) package contains four mounting locations for screws that can secure the amplifier package in dynamic applications and for thermal contact. Ensure that the backside case temperature never exceeds 70°C during operation by attaching the amplifier to a heat sink of suitable size. When

operating with the backside case temperatures greater than 70°C, the lifetime of the device reduces.

Prior to applying dc voltages, terminate both the RF input and RF output to 50 Ω. If dc voltages are applied to the device, do not disconnect the RF output.



## APPLICATIONS INFORMATION

The [HMC-C074](#) is a connectorized amplifier module designed with a single stage amplifier to deliver 29 dBm typical power with a 13 dB gain from 0.01 GHz to 6 GHz. The bias of internal amplifiers is supplied by +15 V and -5 V dc sources that power internal voltage regulators. The [HMC-C074](#) features built-in bias sequencing and active bias control to prevent damage to the amplifiers and to maintain stable performance over temperature.

The [HMC-C074](#) is a miniature module that has SMA connectors for the RF input and output, and robust feed through for the bias and ground returns. Although the [HMC-C074](#) contains bias sequencing circuitry, apply the negative voltage before the positive voltage for optimal performance. This bias sequencing order is especially important in a system where voltages turn off and on rapidly.

For optimal performance, turn on the amplifier as follows:

1. Verify that the dc connections are correct.
2. Apply  $-V_{DC}$  to the supply pin.
3. Apply  $+V_{DC}$  to the supply pin.
4. Apply the RF input and ensure that the power level is correct.

For optimal performance, turn off the amplifier as follows:

1. Turn off the  $+V_{DC}$  supply.
2. Turn off the  $-V_{DC}$  supply.

OUTLINE DIMENSIONS

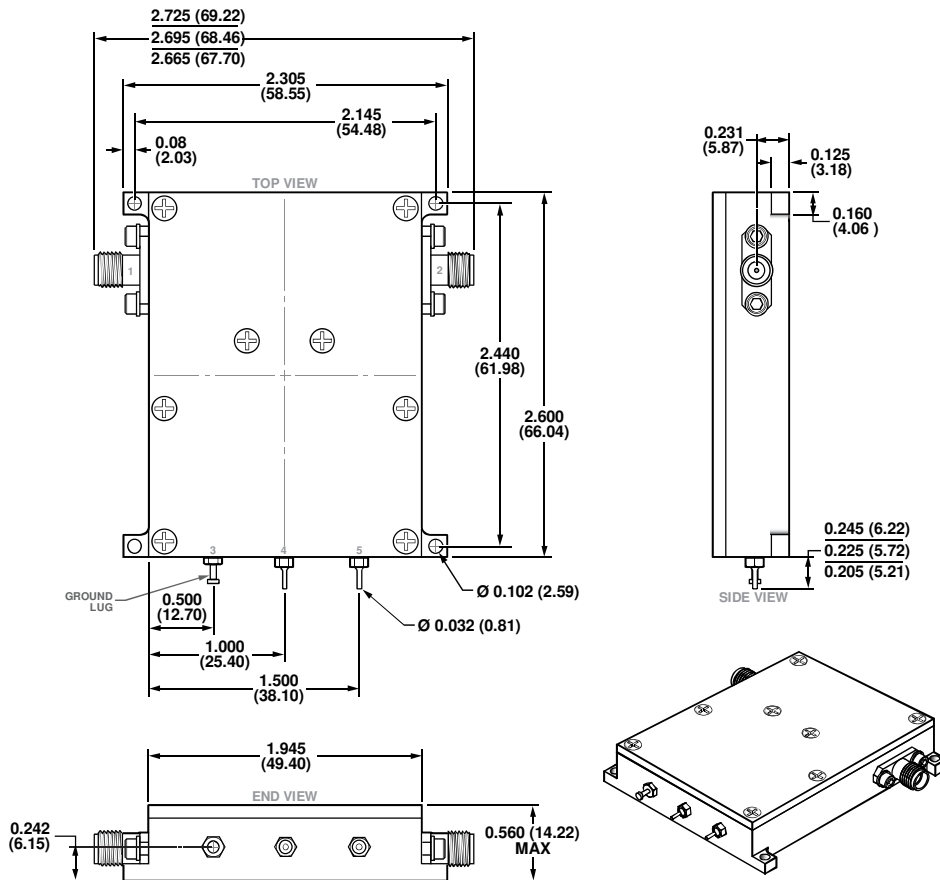

CONTROLLING DIMENSIONS ARE IN INCHES; MILLIMETER DIMENSIONS (IN PARENTHESES) ARE ROUNDED-OFF INCH EQUIVALENTS FOR REFERENCE ONLY AND ARE NOT APPROPRIATE FOR USE IN DESIGN.

Figure 15. 5-Lead Module with Connector Interface [MODULE] (ML-5-2)

Dimensions shown in inches and (millimeters)

ORDERING GUIDE

Model	Temperature Range	Package Description	Package Option
HMC-C074	-40°C to +70°C	5-Lead Module with Connector Interface [MODULE]	ML-5-2