

8A, 50V, 0.300 Ohm, P-Channel Power MOSFETs

These products are P-Channel power MOSFETs manufactured using the MegaFET process. This process, which uses feature sizes approaching those of LSI circuits, gives optimum utilization of silicon, resulting in outstanding performance. They were designed for use in applications such as switching regulators, switching converters, motor drivers, and relay drivers. These transistors can be operated directly from integrated circuits.

Formerly developmental type TA09832.

Ordering Information

PART NUMBER	PACKAGE	BRAND
RFD8P05	TO-251AA	D8P05
RFD8P05SM	TO-252AA	D8P05
RFP8P05	TO-220AB	RFP8P05

NOTE: When ordering, use the entire part number. Add the suffix 9A to obtain the TO-252AA variant in tape and reel, i.e., RFD8P05SM9A.

Features

- 8A, 50V
- $r_{DS(ON)} = 0.300\Omega$
- UIS SOA Rating Curve
- SOA is Power Dissipation Limited
- Nanosecond Switching Speeds
- Linear Transfer Characteristics
- High Input Impedance
- Related Literature
 - TB334 "Guidelines for Soldering Surface Mount Components to PC Boards"

Symbol

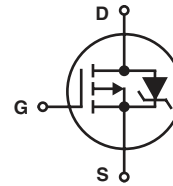

Packaging

JEDEC TO-220AB

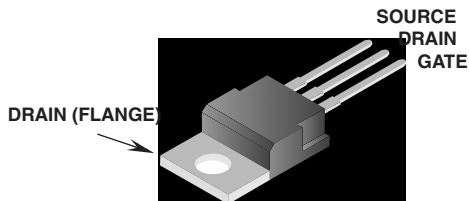

JEDEC TO-251AA

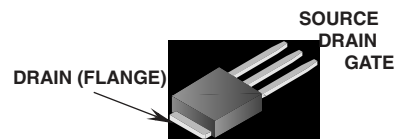

JEDEC TO-252AA

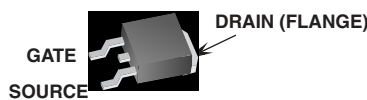

RFD8P05, RFD8P05SM, RFP8P05

Absolute Maximum Ratings $T_C = 25^{\circ}\text{C}$ Unless Otherwise Specified

	RFD8P05, RFD8P05SM, RFP8P05	UNITS
Drain to Source Voltage (Note 1)	-50	V
Drain to Gate Voltage ($R_{GS} = 20\text{K}\Omega$) (Note 1)	-50	V
Continuous Drain Current	-8	A
Pulsed Drain Current (Note 3)	-20	A
Gate to Source Voltage	± 20	V
Maximum Power Dissipation	48	W
Dissipation Derating Factor	0.27	W/ $^{\circ}\text{C}$
Single Pulse Avalanche Energy Rating	See Figure 6	
Operating and Storage Temperature	-55 to 175	$^{\circ}\text{C}$
Maximum Temperature for Soldering		
Leads at 0.063in (1.6mm) from Case for 10s.	300	$^{\circ}\text{C}$
Package Body for 10s, See Techbrief 334	260	$^{\circ}\text{C}$

CAUTION: Stresses above those listed in "Absolute Maximum Ratings" may cause permanent damage to the device. This is a stress only rating and operation of the device at these or any other conditions above those indicated in the operational sections of this specification is not implied.

NOTE:

1. $T_J = 25^{\circ}\text{C}$ to 150°C .

Electrical Specifications $T_C = 25^{\circ}\text{C}$ Unless Otherwise Specified

PARAMETER	SYMBOL	TEST CONDITIONS	MIN	TYP	MAX	UNITS
Drain to Source Breakdown Voltage	BV_{DSS}	$I_D = 250\mu\text{A}$, $V_{GS} = 0\text{V}$ (Figure 9)	-50	-	-	V
Gate Threshold Voltage	$V_{GS(TH)}$	$V_{GS} = V_{DS}$, $I_D = 250\mu\text{A}$ (Figure 8)	-2	-	-4	V
Zero Gate Voltage Drain Current	I_{DSS}	$V_{DS} = \text{Rated } BV_{DSS}$, $V_{GS} = 0\text{V}$	-	-	1	μA
		$V_{DS} = 0.8 \times \text{Rated } BV_{DSS}$, $T_J = 150^{\circ}\text{C}$	-	-	25	μA
Gate to Source Leakage Current	I_{GSS}	$V_{GS} = \pm 20\text{V}$	-	-	± 100	nA
Drain to Source On Resistance (Note 2)	$r_{DS(ON)}$	$I_D = 8\text{A}$, $V_{GS} = -10\text{V}$ (Figure 7)	-	-	0.300	Ω
Turn-On Time	t_{ON}	$V_{DD} = -25\text{V}$, $I_D \approx 4\text{A}$, $R_G = 9.1\Omega$, $R_L = 6.25\Omega$, $V_{GS} = -10\text{V}$	-	-	60	ns
Turn-On Delay Time	$t_{d(ON)}$		-	16	-	ns
Rise Time	t_r		-	30	-	ns
Turn-Off Delay Time	$t_{d(OFF)}$		-	42	-	ns
Fall Time	t_f		-	20	-	ns
Turn-Off Time	t_{OFF}		-	-	100	ns
Total Gate Charge	$Q_g(\text{TOT})$	$V_{GS} = 0$ to -20V	-	-	80	nC
Gate Charge at -5V	$Q_g(-10)$	$V_{GS} = 0$ to -10V				
Threshold Gate Charge	$Q_g(\text{TH})$	$V_{GS} = 0$ to -2V				
Thermal Resistance Junction to Case	$R_{\theta JC}$		-	-	3.125	$^{\circ}\text{C}/\text{W}$
Thermal Resistance Junction to Ambient	$R_{\theta JA}$	TO-251AA, TO-252AA	-	-	100	$^{\circ}\text{C}/\text{W}$
		TO-220AB	-	-	62.5	$^{\circ}\text{C}/\text{W}$

Source to Drain Diode Specifications $T_C = 25^{\circ}\text{C}$ Unless Otherwise Specified

PARAMETER	SYMBOL	TEST CONDITIONS	MIN	TYP	MAX	UNITS
Source to Drain Diode Voltage (Note 2)	V_{SD}	$I_{SD} = -8\text{A}$	-	-	-1.5	V
Reverse Recovery Time	t_{rr}	$I_{SD} = -8\text{A}$, $dI_{SD}/dt = 100\text{A}/\mu\text{s}$	-	-	125	ns

NOTE:

2. Pulse test: pulse width $\leq 300\mu\text{s}$, Duty Cycle $\leq 2\%$.
3. Repetitive rating: pulse width is limited by maximum junction temperature.

Typical Performance Curves Unless Otherwise Specified

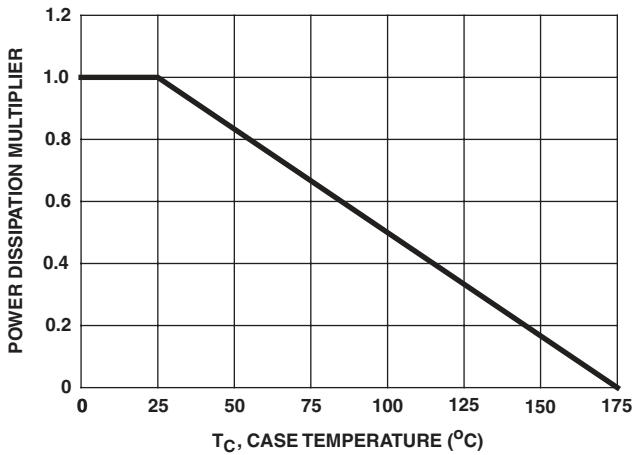

FIGURE 1. NORMALIZED POWER DISSIPATION vs CASE TEMPERATURE

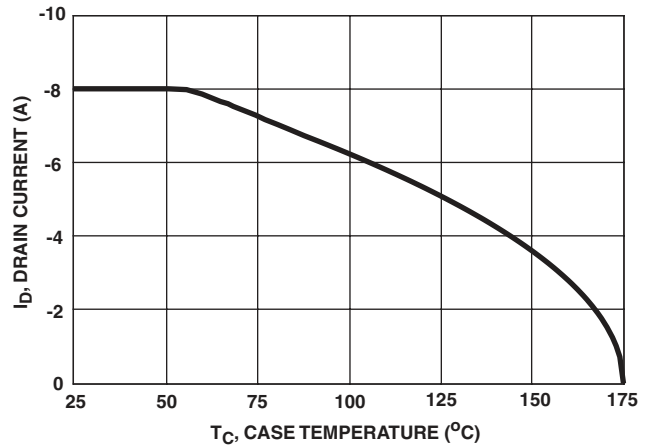

FIGURE 2. MAXIMUM CONTINUOUS DRAIN CURRENT vs CASE TEMPERATURE

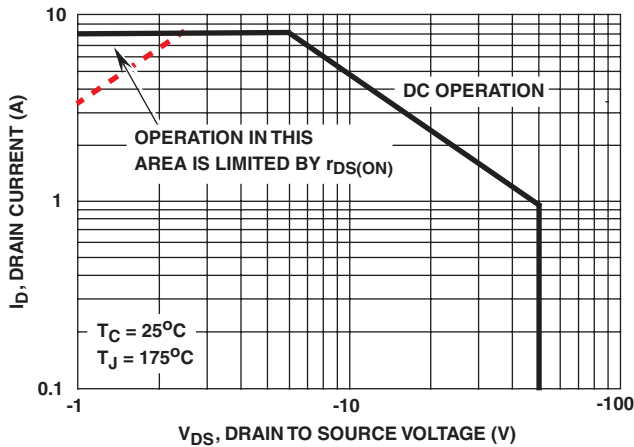

FIGURE 3. FORWARD BIAS SAFE OPERATING AREA

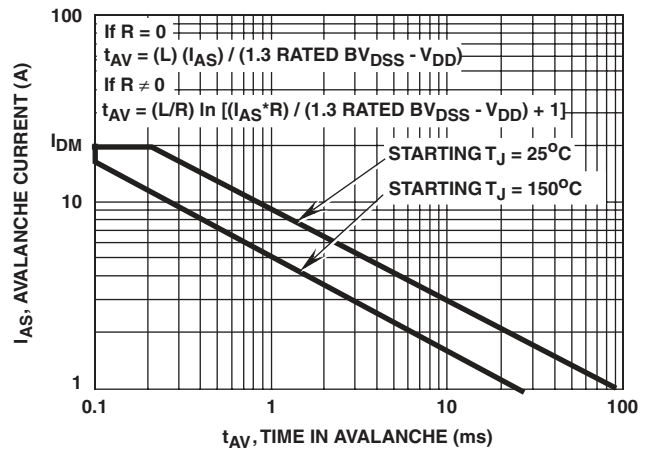

FIGURE 4. UNCLAMPED INDUCTIVE SWITCHING CAPABILITY

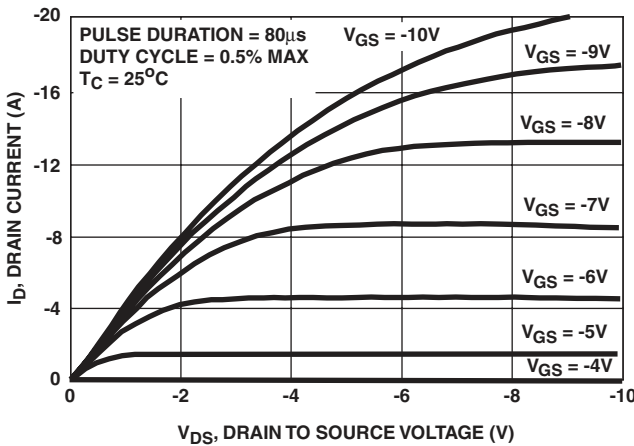

FIGURE 5. SATURATION CHARACTERISTICS

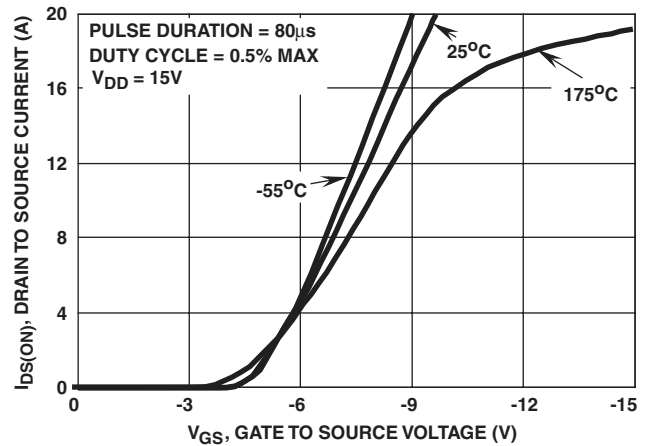

FIGURE 6. TRANSFER CHARACTERISTICS

Typical Performance Curves Unless Otherwise Specified

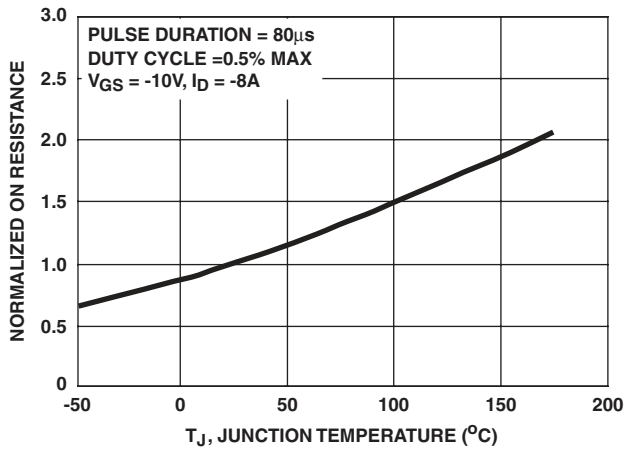

FIGURE 7. NORMALIZED DRAIN TO SOURCE ON RESISTANCE vs JUNCTION TEMPERATURE

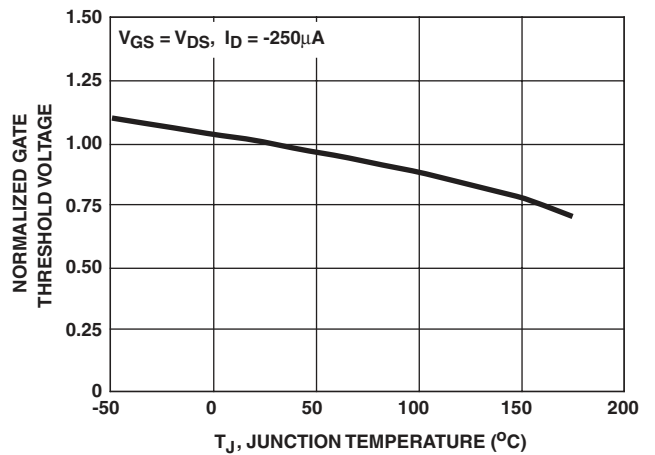

FIGURE 8. NORMALIZED GATE THRESHOLD VOLTAGE vs JUNCTION TEMPERATURE

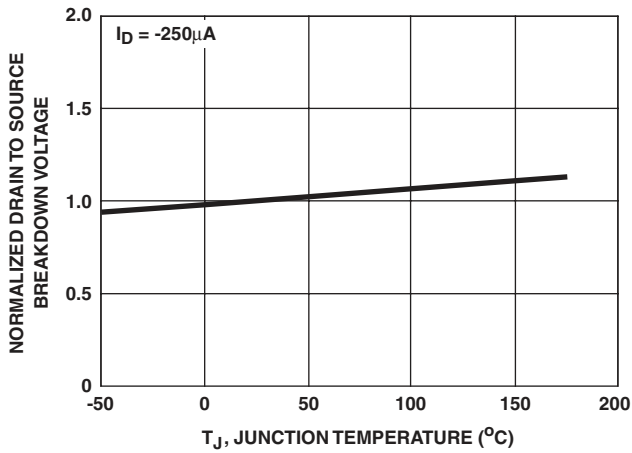

FIGURE 9. NORMALIZED DRAIN TO SOURCE BREAKDOWN VOLTAGE vs JUNCTION TEMPERATURE

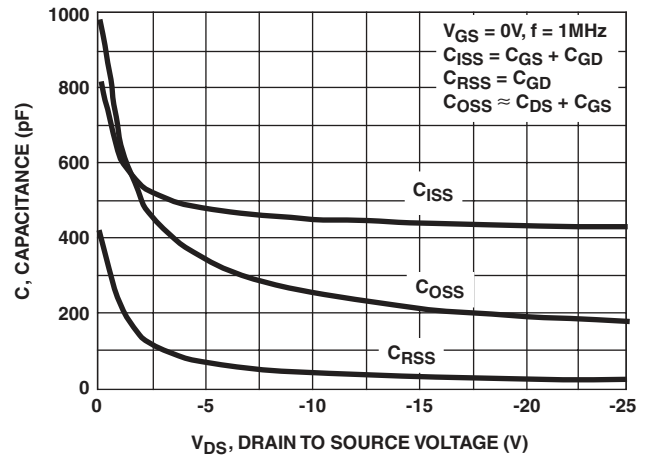
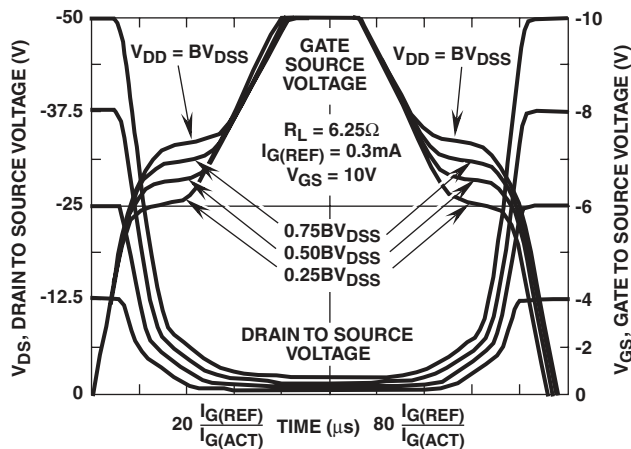

FIGURE 10. CAPACITANCE vs DRAIN TO SOURCE VOLTAGE



NOTE: Refer to Application Notes AN7254 and AN7260.

FIGURE 11. NORMALIZED SWITCHING WAVEFORMS FOR CONSTANT GATE CURRENT

Test Circuits and Waveforms

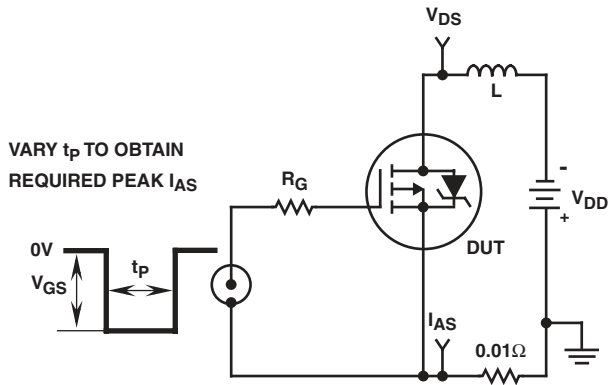

FIGURE 12. UNCLAMPED ENERGY TEST CIRCUIT

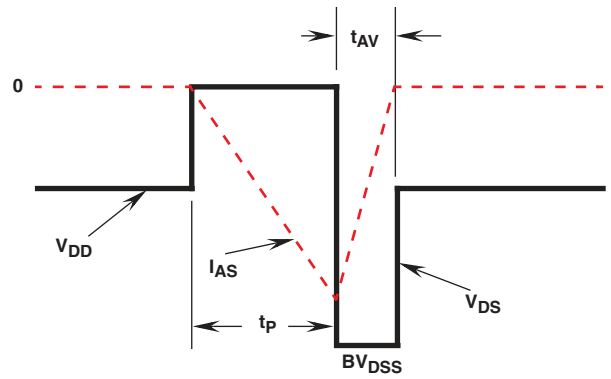

FIGURE 13. UNCLAMPED ENERGY WAVEFORMS

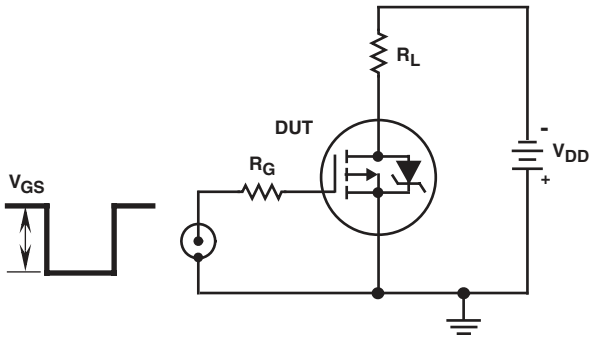

FIGURE 14. SWITCHING TIME TEST CIRCUIT

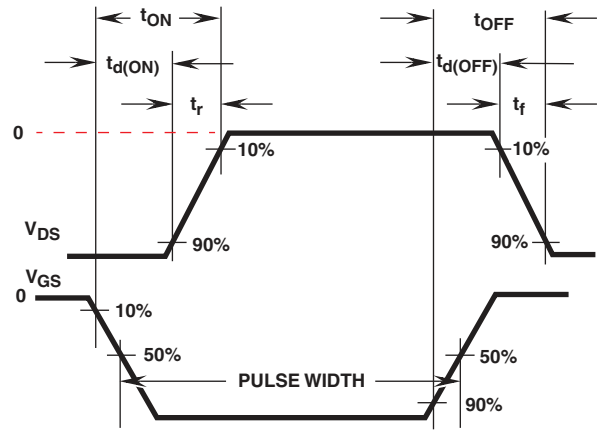

FIGURE 15. RESISTIVE SWITCHING WAVEFORMS

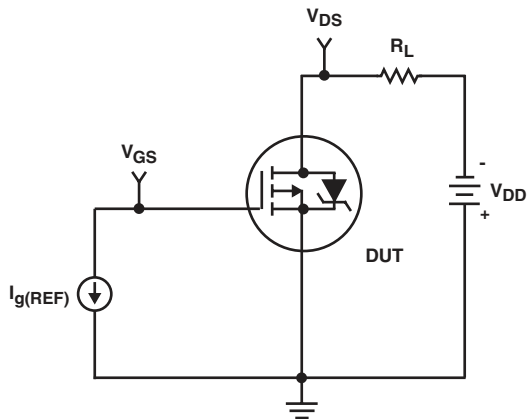

FIGURE 16. GATE CHARGE TEST CIRCUIT

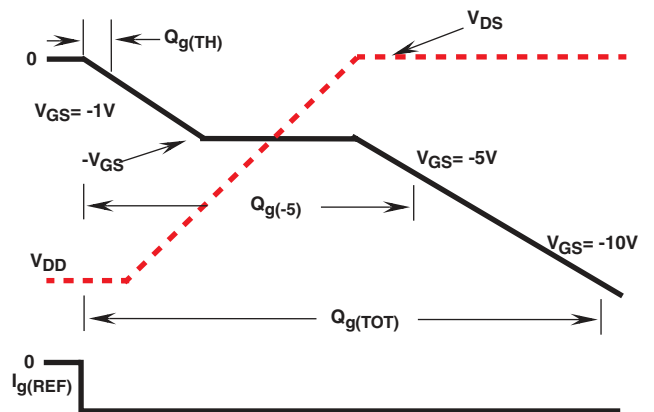

FIGURE 17. GATE CHARGE WAVEFORMS

TRADEMARKS

The following are registered and unregistered trademarks Fairchild Semiconductor owns or is authorized to use and is not intended to be an exhaustive list of all such trademarks.

ACE _x [™]	FAST [®]	OPTOLOGIC [™]	SMART START [™]	VCX [™]
Bottomless [™]	FAST _r [™]	OPTOPLANAR [™]	STAR*POWER [™]	
CoolFET [™]	FRFET [™]	PACMAN [™]	Stealth [™]	
CROSSVOLT [™]	GlobalOptoisolator [™]	POP [™]	SuperSOT [™] -3	
DenseTrench [™]	GTO [™]	Power247 [™]	SuperSOT [™] -6	
DOME [™]	HiSeC [™]	PowerTrench [®]	SuperSOT [™] -8	
EcoSPARK [™]	ISOPLANAR [™]	QFET [™]	SyncFET [™]	
E ² CMOS [™]	LittleFET [™]	QS [™]	TinyLogic [™]	
EnSigna [™]	MicroFET [™]	QT Optoelectronics [™]	TruTranslation [™]	
FACT [™]	MicroPak [™]	Quiet Series [™]	UHC [™]	
FACT Quiet Series [™]	MICROWIRE [™]	SILENT SWITCHER [®]	UltraFET [®]	

STAR*POWER is used under license

DISCLAIMER

FAIRCHILD SEMICONDUCTOR RESERVES THE RIGHT TO MAKE CHANGES WITHOUT FURTHER NOTICE TO ANY PRODUCTS HEREIN TO IMPROVE RELIABILITY, FUNCTION OR DESIGN. FAIRCHILD DOES NOT ASSUME ANY LIABILITY ARISING OUT OF THE APPLICATION OR USE OF ANY PRODUCT OR CIRCUIT DESCRIBED HEREIN; NEITHER DOES IT CONVEY ANY LICENSE UNDER ITS PATENT RIGHTS, NOR THE RIGHTS OF OTHERS.

LIFE SUPPORT POLICY

FAIRCHILD'S PRODUCTS ARE NOT AUTHORIZED FOR USE AS CRITICAL COMPONENTS IN LIFE SUPPORT DEVICES OR SYSTEMS WITHOUT THE EXPRESS WRITTEN APPROVAL OF FAIRCHILD SEMICONDUCTOR CORPORATION.

As used herein:

1. Life support devices or systems are devices or systems which, (a) are intended for surgical implant into the body, or (b) support or sustain life, or (c) whose failure to perform when properly used in accordance with instructions for use provided in the labeling, can be reasonably expected to result in significant injury to the user.
2. A critical component is any component of a life support device or system whose failure to perform can be reasonably expected to cause the failure of the life support device or system, or to affect its safety or effectiveness.

PRODUCT STATUS DEFINITIONS

Definition of Terms

Datasheet Identification	Product Status	Definition
Advance Information	Formative or In Design	This datasheet contains the design specifications for product development. Specifications may change in any manner without notice.
Preliminary	First Production	This datasheet contains preliminary data, and supplementary data will be published at a later date. Fairchild Semiconductor reserves the right to make changes at any time without notice in order to improve design.
No Identification Needed	Full Production	This datasheet contains final specifications. Fairchild Semiconductor reserves the right to make changes at any time without notice in order to improve design.
Obsolete	Not In Production	This datasheet contains specifications on a product that has been discontinued by Fairchild semiconductor. The datasheet is printed for reference information only.