



Connectors > Power Connectors > Circular Power > Circular Power Connectors > Circular Connector, Environmentally Sealed, CPC Series 6



Connector Product Type: **Housing**

Operating Voltage: **600 VDC**

Connector System: **Wire-to-Wire**

Number of Positions: **14**

Sealable: **Yes**

[All Circular Connector, Environmentally Sealed, CPC Series 6 \(19\)](#)

Features

Product Type Features

Connector Seal & Plug Type	Peripheral
Connector Product Type	Housing
Connector System	Wire-to-Wire
Sealable	Yes
Connector & Contact Terminates To	Wire & Cable
Connector & Housing Type	Receptacle
Circular Connector Shell Type	All Plastic

Configuration Features

Reverse Numbering	Without
Number of Positions	14
Number of Power Positions	0
Number of Signal Positions	14



Electrical Characteristics

Operating Voltage	600 VAC
-------------------	---------

Contact Features

Reverse Gender	Yes
Contact Type	Socket
Contact Protection	With

Mechanical Attachment

Mating Alignment Type	Keyed
Mating Alignment	With
Panel Mount Feature Type	Flange with Mounting Holes
Mating Retention Type	Threaded Coupling
Thread Size	15/16-20 UNEF – 2A
Polarization Code	A
Connector Mounting Type	Panel Mount
Mating Retention	With
Panel Mount Feature	With

Housing Features

Body Orientation	Straight
Housing Color	Black
Housing Material	Thermoplastic
Circular Connector Shell Size	17

Usage Conditions

Operating Temperature Range	-55 – 105 °C[-67 – 221 °F]
Fluid Resistance	Immersion

Operation/Application

Circuit Application	Power & Signal
Shielded	No

Industry Standards

UL Flammability Rating	UL 94V-0
------------------------	----------

Packaging Features

Packaging Quantity	1
Packaging Method	Standard



Product Compliance

[For compliance documentation, visit the product page on TE.com>](#)

EU RoHS Directive 2011/65/EU	Compliant
EU ELV Directive 2000/53/EC	Compliant
China RoHS 2 Directive MIIT Order No 32, 2016	No Restricted Materials Above Threshold
EU REACH Regulation (EC) No. 1907/2006	Current ECHA Candidate List: JUNE 2023 (235) Candidate List Declared Against: JUNE 2023 (235) Does not contain REACH SVHC
Halogen Content	BFR/CFR/PVC Free, but Br/Cl >900 ppm in other sources.
Solder Process Capability	Not applicable for solder process capability

Product Compliance Disclaimer

This information is provided based on reasonable inquiry of our suppliers and represents our current actual knowledge based on the information they provided. This information is subject to change. The part numbers that TE has identified as EU RoHS compliant have a maximum concentration of 0.1% by weight in homogenous materials for lead, hexavalent chromium, mercury, PBB, PBDE, DBP, BBP, DEHP, DIBP, and 0.01% for cadmium, or qualify for an exemption to these limits as defined in the Annexes of Directive 2011/65/EU (RoHS2). Finished electrical and electronic equipment products will be CE marked as required by Directive 2011/65/EU. Components may not be CE marked. Additionally, the part numbers that TE has identified as EU ELV compliant have a maximum concentration of 0.1% by weight in homogenous materials for lead, hexavalent chromium, and mercury, and 0.01% for cadmium, or qualify for an exemption to these limits as defined in the Annexes of Directive 2000/53/EC (ELV). Regarding the REACH Regulation, the information TE provides on SVHC in articles for this part number is based on the latest European Chemicals Agency (ECHA) 'Guidance on requirements for substances in articles' posted at this URL: <https://echa.europa.eu/guidance-documents/guidance-on-reach>

Compatible Parts

<p>TE Part # CAT-AM71-C83998 CPC Heat Shrink Strain Reliefs</p>	<p>TE Part # 81665-2 FLANGE GASKET CPC</p>	<p>TE Part # 206044-1 CPC PLUG ASSEMBLY SIZE 17-14</p>	<p>TE Part # 208652-1 SEALING CAP ASSY,SZ 17,CPC</p>



TE Part # 207445-3
SEALING CAP ASSY, 17, CPC ROHS

Compliant



TE Part # 4-2407269-2
CAP, CPC, SIZE 17 RECP, BLACK



TE Part # 4-2407269-3
CAP, CPC, SIZE 17 RECP, RED



TE Part # 4-2407269-4
CAP, CPC, SIZE 17 RECP, YELLOW



TE Part # 4-2407269-1
CAP, CPC, SIZE 17 RECP, ORANGE

Also in the Series | AMP CPC



Circular Connector Adapters(7)



Circular Connector Caps & Covers(16)



Circular Connector Hardware(3)



Circular Connector Keying Plugs(2)



Circular Connector Seals(36)



Circular Power Connectors(459)



Connector Backshells(56)



Connector Strain Relief(6)



Insertion & Extraction Tools(1)



Power Contacts(6)



Sealing Sleeves(2)

Customers Also Bought

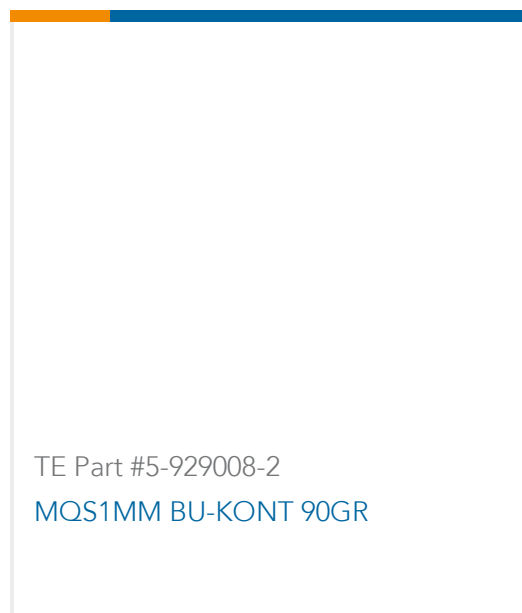
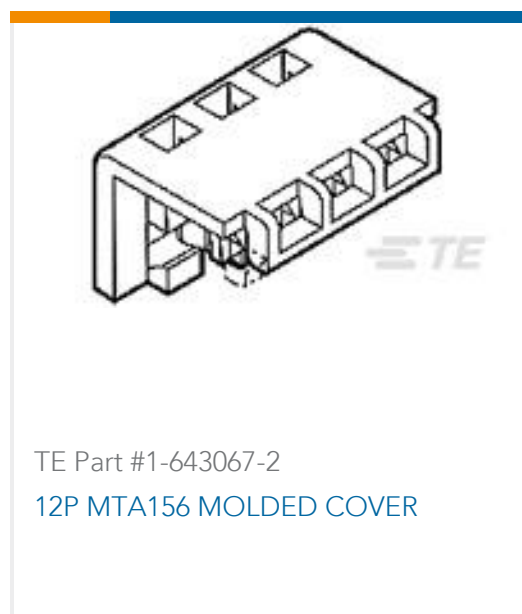

Documents

CAD Files

3D PDF

3D

Customer View Model

[ENG_CVM_CVM_206043-4_AN.2d_dxf.zip](#)

English

Customer View Model

[ENG_CVM_CVM_206043-4_AN.3d_igs.zip](#)

English

Customer View Model

[ENG_CVM_CVM_206043-4_AN.3d_stp.zip](#)

English

By downloading the CAD file I accept and agree to the [Terms and Conditions](#) of use.

Datasheets & Catalog Pages

[AMP Circular Connectors for Commercial Signal & Power Applications](#)

English

Product Specifications



Application Specification

English

Product Environmental Compliance

MD_206043-4_05052014648_dmtec

English

MD_206043-4_05052014648_dmtec

English

Instruction Sheets

Instruction Sheet (U.S.)

English

Agency Approvals

UL Report

English