

PART NO. SEE CHART
 DRG. NO. SDA-90298

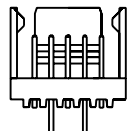

FOR CCTS 2 THRU 5

WAFER: POLYESTER 94V-0
 PIN (0.635) / .025 SQ. BRASS
 PREPLATED ELECTRO-TIN
 (5UM) / .0002 MIN. OVER (2.5UM) / .0001
 COPPER MIN.

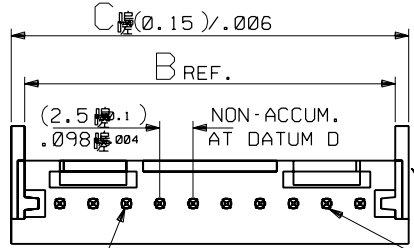
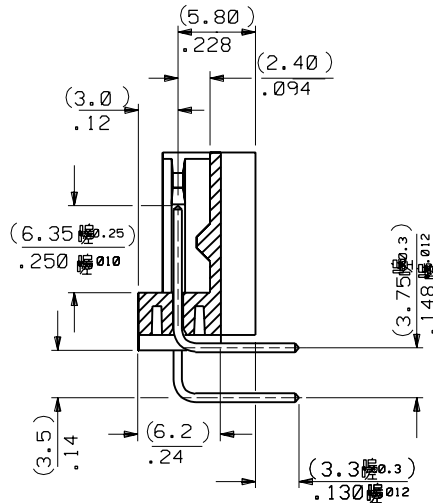
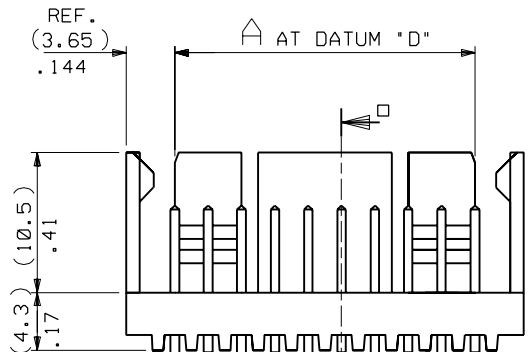
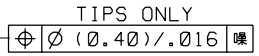

SECTION X-X

PIN NO 1
 SEE NOTE 1

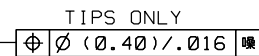

- NOTES:
- PIN 1 TO BE POSITIONED AS SHOWN FOR ALL CCT. SIZES.
 - PIN PUSH OUT FORCE (0.907)/2 LBS MIN.
 - SOLDERABILITY TO MOLEX SPEC. ES-152.
 - RECOMMENDED PCB THICKNESS (1.5) / .060

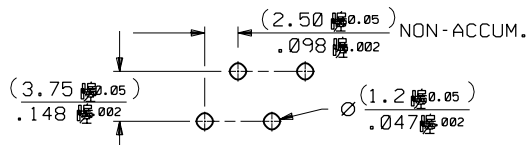

RECOMMENDED PCB HOLE DIMNS.
 VIEWED FROM COMPONENT SIDE

CCTS	DRG. NO	DIMN. A	DIMN. B	DIMN. C	TOOLING
2	90298-0002	2.50 ± 0.10 .098 ± .004	7.80 .307	9.80 .386	TOOLED
3	0003	5.00 ± 0.10 .197 ± .004	10.30 .406	12.30 .484	
4	0004	7.50 ± 0.10 .295 ± .004	12.80 .504	14.80 .583	
5	0005	10.00 ± 0.10 .394 ± .004	15.30 .602	17.30 .681	
6	0006	12.50 ± 0.10 .492 ± .004	17.80 .701	19.80 .780	
7	0007	15.00 ± 0.10 .591 ± .004	20.30 .799	22.30 .878	
8	0008	17.50 ± 0.10 .689 ± .004	22.80 .898	24.80 .976	
9	0009	20.00 ± 0.10 .787 ± .004	25.30 .996	27.30 1.075	
10	0010	22.50 ± 0.13 .886 ± .005	27.80 1.094	29.80 1.173	
11	0011	25.00 ± 0.13 .984 ± .005	30.30 1.193	32.30 1.272	
12	0012	27.50 ± 0.13 1.083 ± .005	32.80 1.291	34.80 1.370	
13	0013	30.00 ± 0.15 1.181 ± .006	35.30 1.390	37.30 1.469	
14	0014	32.50 ± 0.15 1.280 ± .006	37.80 1.488	39.80 1.567	
15	0015	35.00 ± 0.15 1.378 ± .006	40.30 1.587	42.30 1.665	
16	0016	37.50 ± 0.15 1.476 ± .006	42.80 1.685	44.80 1.764	
17	0017	40.00 ± 0.15 1.575 ± .006	45.30 1.783	47.30 1.862	
18	0018	42.50 ± 0.18 1.673 ± .007	47.80 1.882	49.80 1.961	
19	0019	45.00 ± 0.18 1.772 ± .007	50.30 1.980	52.30 2.059	
20	90298-0020	47.50 ± 0.18 1.870 ± .007	52.80 2.079	54.80 2.157	TOOLED

REVISE ONLY ON CAD SYSTEM SHL REV.

CAD/CAM FILENAME: S490298X1 DGN
 THIS DRAWING CONTAINS INFORMATION THAT IS PROPRIETARY TO MOLEX INC. & SHOULD NOT BE USED WITHOUT WRITTEN PERMISSION

TITLE: RIGHT ANGLE, STAGGERED, SHROUDED WAFER ASSY, MULTI-PURPOSE, (2.5)/.098 CTRS.

MOLEX EUROPE SHEET NO. DATE: 10F1 13/8 /86

PART NO. SEE CHART DWG. NO. SDA-90298 SIZE B

FOR PREVIOUS DRAWING ISSUES SEE MRI.

MODIFIED ECO MEML 701 MC 13.8.86

DRWG BY: MCC
 CHK'D BY:
 APP'D BY:
 SCALE: 3:1

DIMENSIONS SHOWN (METRIC) INCH UNLESS OTHERWISE SPECIFIED TOLERANCES: ANGULAR ± 1/2°

3 PLACE	± .006		
2 PLACE	± .015	± .015	
1 PLACE			± .038

DRAFT WHERE APPLICABLE MUST REMAIN WITHIN DIMENSIONS

DESIGN DIMENSION (MM) (INCH)
 (PRIMARY) IN.

EQUIVALENT DIMENSION (MM) (INCH)
 (SECONDARY) IN.