

## 电源产品规格书

### Power supply product specification

产品名称：75W—LED 驱动条形电源

Product Name: 75W—LED Strip Power Supply

产品型号：AD-EL-1200/2400750-B

Product Item: AD-EL-1200/2400750-B

Shanghai Edgelight Industry Co.,Ltd.

TEL:+86-21-64412288

FAX:+86-21-64412266

E-mail: [info@edgelight.com](mailto:info@edgelight.com)

## 1、产品简介 Product Introductions

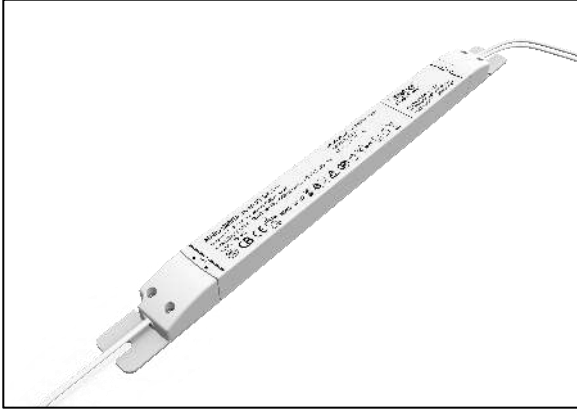

**AD-EL-1200750-B**

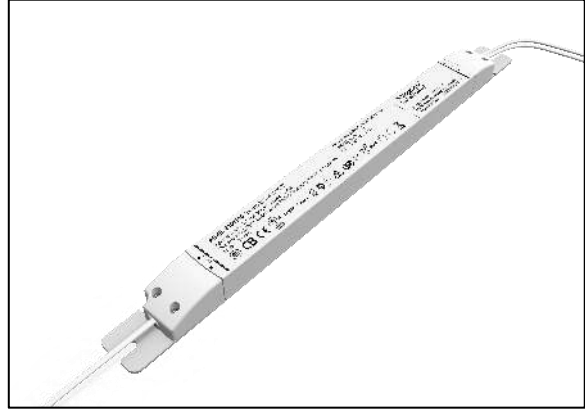

**AD-EL-2400750-B**

- 电气类型：隔离电源

Electrical type: Isolated power supply

- 功能说明：全电压（半电压）无频闪

Function description: Full voltage (half voltage) without stroboscopic

- 产品特性：class 2 & SELV 全电压范围内满载输出，高性能，高效率，可以连接我司 three-in-one 调光控制器构成 pwm/0-10v/resistor 调光电源

Product features: Class 2 & SELV full-load output in full voltage range, high performance, high efficiency, can be connected to our three-in-one dimming controller to form pwm/0-10v/resistor dimming power supply

- 应用领域：LED 照明领域

Application area: LED lighting field

- 质保：参见产品寿命曲线

Warranty: To refer product life curve

- 认证：

Certification:             

## 2、电气规格 Electrical specifications

指标 Index	型号全称 Full name of model	AD-EL-1200750-B	AD-EL-2400750-B
输出特性 Output characteristic	输出电压 Output voltage	12V	24V
	输出电流 Output current	6.25A	3.125A
	纹波电压+噪音 (峰值) Ripple voltage + noise(peak-to-peak)	300mV ( Vp-p )	200mV ( Vp-p )
	电压精度 Voltage accuracy	±2%	±1%
	启动时间 (最大值) Start time (maximum)	400ms	700ms
	温度漂移 Temperature drift	±0.03%/°C ( 0-60°C )	±0.03%/°C ( 0-60°C )
	输出线性调整率 Output linear adjustment rate	±2%	±2%
	负载调整率 Load regulation rate	±2%	±2%
	保持时间 Preserve time	40ms	40ms
	输入特性 Input characteristics	输入电压 Input voltage	100VAC~240VAC
输入频率 Input frequency		50HZ/60HZ	50HZ/60HZ
输入电流 (最大值) Input current (maximum)		0.9A	0.9A
漏电流 Leakage current		0.8mA	0.8mA

	总谐波 Total harmonic	< 20%	< 20%
	功率因数 Power factor	> 0.9	> 0.9
	效率 Efficiency	92%	92%
	浪涌电流 Surge current	冷启动 40A @230Vac Cold start 40A @230Vac	
	空载功耗/待机功耗 No-load power consumption / standby power consumption	1W	1.1W
保护特性 Protection characteristics	过流保护 Over current protection	10A	5A
	短路保护 Short circuit protection	有 yes	有 yes
环境描述 Environmental description	工作温度 Operating temperature	Tcase = -20°C-50°C	
	工作湿度 Working humidity	20-95%RH, 无冷凝	
	存储温度-湿度 Storage temperature-humidity	-20°C-50°C 10-95%RH	
	大气压强 Atmospheric pressure	86-106KPa	
安全及规范 Safety and regulation	认证 Certification	CE、CB、UL-8750+Class P	
	耐压 Pressure resistant	I/P-O/P:3KVAC	
	绝缘阻抗 Insulation resistance	I/P-O/P, I/P-FG,O/P-FG:100MΩ/500Vdc/70%RH	

	电磁兼容干扰 Electromagnetic compatibility interference	符合 EN55015、EN61000-3-2、EN61000-3-3 , EN61547 标准要求 Meets EN55015, EN61000-3-2, EN61000-3-3, EN61547 requirements	
	电磁兼容抗干扰 Electromagnetic compatibility anti-jamming	EN61000-3-2 , EN61000-3-3 , EN61547 标准要求 EN61000-3-2, EN61000-3-3, EN61547 standard requirements	
其他 others	包装 Package	净重量约 201g , 包装 230g*80pcs ; 18.4kg The net weight is about 201g, and the package is 230g*80pcs; 18.4kg	净重量 204g , 包装 230*80pcs;18.4kg Net weight 204g, packaging 230*80pcs; 18.4kg
	尺寸 size	377*30*20mm	
	IP 等级说明 IP Level description	IP20	
	质保说明 Warranty description	≥2 年 , 参见寿命曲线 ≥ 2 years, refer to life curve	≥2 年 , 参见寿命曲线 ≥ 2 years, refer to life curve
	测试设备 Test Equipment	LCR METER: TH2830, fluke 数字万用表, 电子负载 : PEL-3041 , 交流源 : 远方 PPS1010、功率分析仪 : Ainuo , 数字示波器 : SDS3034E , 传导分析仪 : 远方 LS-3、FFT3030 , 接地电阻测试仪 : MS2520C 型 , 耐压测试仪 : TH9320 , 烤箱 , 电脑监控老化测试系统。 LCR METER: TH2830, fluke digital multimeter, electronic load: PEL-3041, AC source: remote PPS1010, power analyzer: Ainuo, digital oscilloscope: SDS3034E, conduction analyzer: remote LS-3, FFT3030, ground resistance tester: MS2520C Type, withstand voltage tester: TH9320, oven, computer monitoring aging test system.	
测试说明 Test instruction	纹波电压测试方法 : 示波器探头设置 AC , 带宽设置 20M , 在输出端并接 10uF 电解电容/100nF 贴片电容。除温升测试项目外 , 其余测试温度均在 25°C , 230Vac 条件下。 Ripple voltage test method: The oscilloscope probe is set to AC, the bandwidth is set to 20M, and 10uF electrolytic capacitor/100nF chip capacitor is connected at the output end. Except for the temperature rise test project, the rest of the test temperature is at 25°C, 230 Vac.		

### 3、产品寿命 Product life span

在一个密闭空间内，当环境温度达到 30°C，40°C，50°C，60°C，70°C时，计算产品使用寿命

In a confined space, when the ambient temperature reaches 30 ° C, 40 ° C, 50 ° C, 60 ° C, 70 ° C, Calculate product life

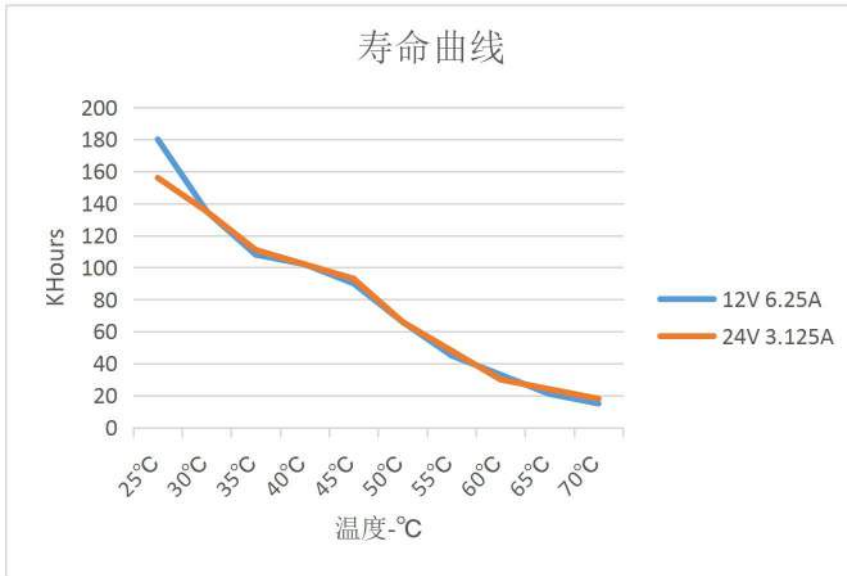

### 4、输出负载 VS 环境温度

Output load VS ambient temperature

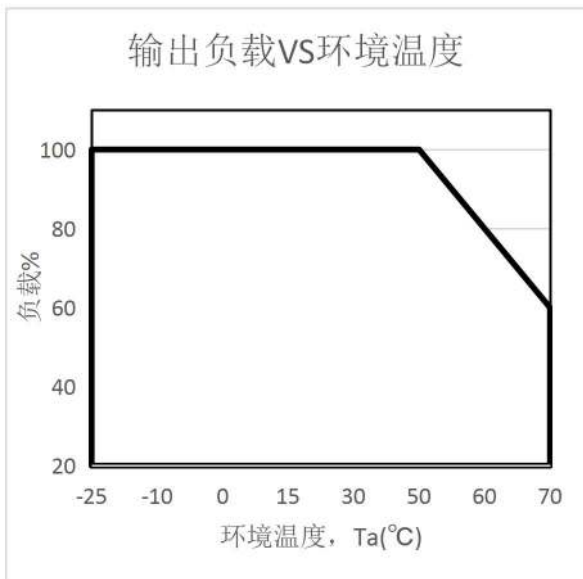

### 5、静态特性曲线

Static characteristic curve

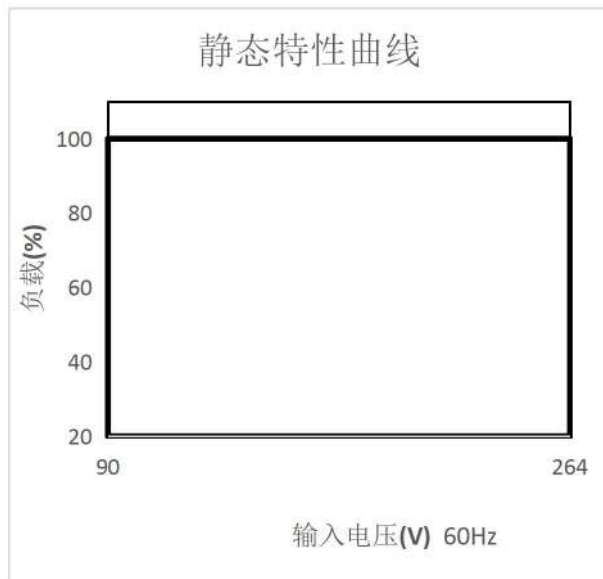

### 6、功率因素特性曲线

Power factor characteristic curve

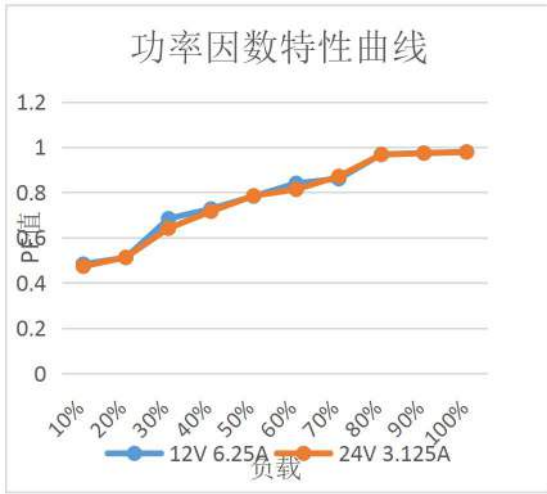

### 7、总谐波失真特性曲线

Total harmonic distortion characteristic curve

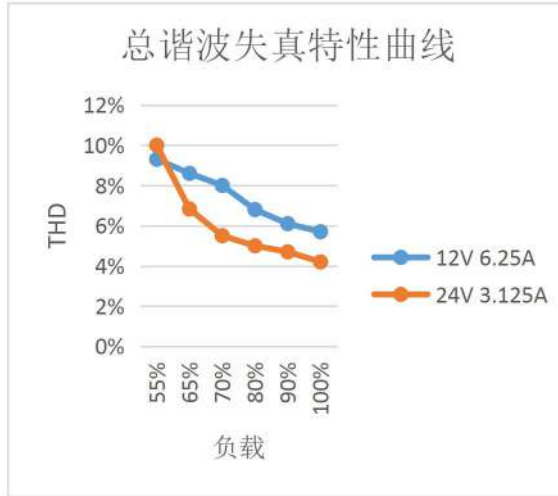

### 8、效率 VS 负载

Efficiency vs load

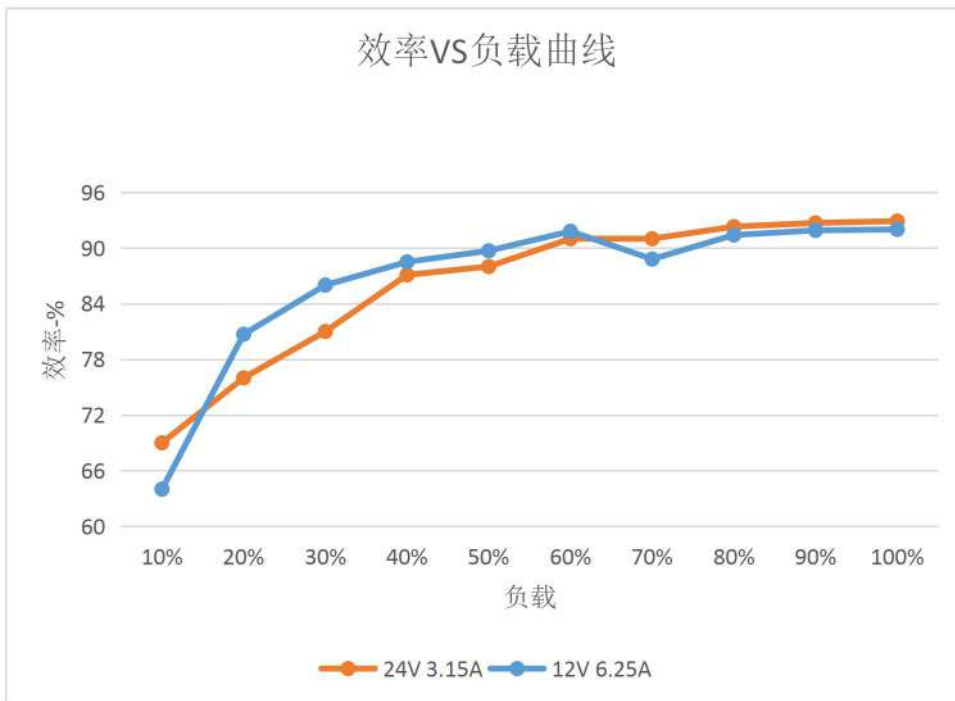



### 9、结合调光器使用连接图

Use the connection diagram with the dimmer

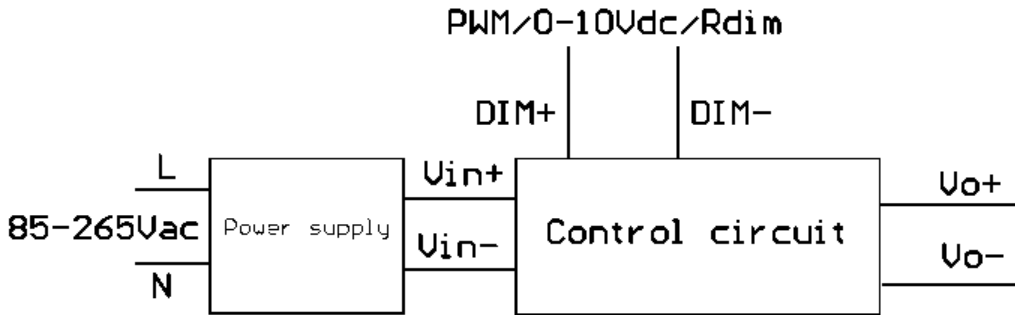

三合一调光功能：

在 DIM+和 DIM-间连接一个电阻或连接 0-10V 直流电压或 PWM 信号，即可调整输出恒电流的数值。  
Vo+和 Vo-之间直接连接 12V 或者 24V 的 LED 灯条或灯带。

Three-in-one dimming function:

The output constant current value can be adjusted by connecting a resistor or connecting a 0-10V DC voltage or PWM signal between DIM+ and DIM-.

A 12V or 24V LED strip or strip is directly connected between Vo+ and Vo-.

实物图连接如下：

The material is connected in the picture as follows:



调光功能说明：

Dimming function description:



1.0-10V 调光：调光范围 0%-100%

0-10V light modulator: light modulator range 0%-100%

调光电压 Dimming voltage	0V	1V	2V	3V	4V	5V	6V	7V	8V	9V	10V	OPEN
额定电流百分比 Rated current percentage	关断	12.5%	17%	30%	40%	49%	61%	73%	80%	83%	91%	95%-105%

2.电阻调光：调光范围 10%-100%，电阻阻值范围：2KΩ-20kΩ

Resistance dimming: Dimming range 10%-100%, resistance range: 2KΩ-20kΩ

调光电阻阻值 Light modulator resistance	2kΩ	4kΩ	6kΩ	8kΩ	10kΩ	12kΩ	14kΩ	16kΩ	18kΩ	20kΩ	OPEN
额定电流百分比 Rated current percentage	6%	17%	26%	37%	46%	57%	68%	79%	95%	99.5%	95%-105%

3.PWM 调光：调光范围 10%-100%，采用幅值为 10V，频率为 500Hz-5KHz 的 PWM 信号调节

PWM dimming: dimming range 10%-100%, PWM signal adjustment with amplitude of 10V and frequency of 500Hz-5KHz

PWM 信号占空比 PWM signal duty cycle	10%	20%	30%	40%	50%	60%	70%	80%	90%	100%	OPEN
额定电流百分比 Rated current percentage	5%	17%	30%	40%	50%	60%	70%	80%	90%	100%	95%-105%

## 8、外观尺寸 Exterior dimension

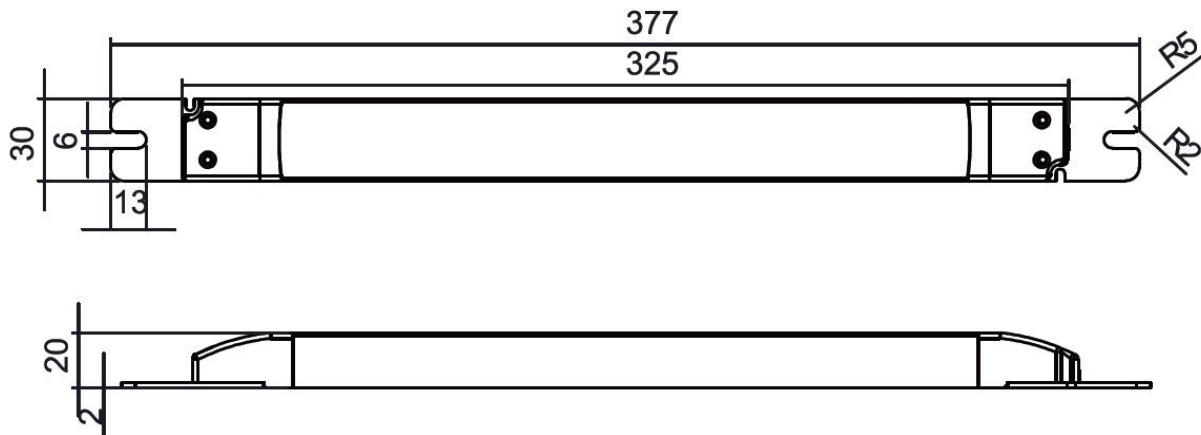

## 9、铭牌 Label

<p><b>AD-EL-1200750</b> (model/型号/品番/모델) Input (输入/入力/입력): 100-240VAC, 50/60Hz <math>\lambda &gt; 0.9</math> Output (输出/出力/출력): 12VDC, Max. (最大电流值/最大電流値/최대전류값) 6.25A 75W Tc: 85°C Ta: 45°C</p>	<p>LED POWER SUPPLY (LED控制装置 恒压型/ LED制御装置定圧タイプ/ LED 제어 장치 정압 타입)</p> <p>UL US ROHS Class P</p>	<p><b>EdgeLight®</b> Shift Lighting Technology</p> <p>Shanghai Edgelight Industry Co., Ltd. Add: 55 Beimin Rd. Songjiang District, Shanghai 上海边光实业有限公司 上海市松江区北闵路55号</p>
<p><b>AD-EL-2400750</b> (model/型号/品番/모델) Input (输入/入力/입력): 100-240VAC, 50/60Hz <math>\lambda &gt; 0.9</math> Output (输出/出力/출력): 24VDC, Max. (最大电流值/最大電流値/최대전류값) 3.125A 75W Tc: 85°C Ta: 45°C</p>	<p>LED POWER SUPPLY (LED控制装置 恒压型/ LED制御装置定圧タイプ/ LED 제어 장치 정압 타입)</p> <p>UL US ROHS Class P</p>	<p><b>EdgeLight®</b> Shift Lighting Technology</p> <p>Shanghai Edgelight Industry Co., Ltd. Add: 55 Beimin Rd. Songjiang District, Shanghai 上海边光实业有限公司 上海市松江区北闵路55号</p>