

## Sensor/actuator box - SACB- 6/3-C QO-0,34 - 1548367

Please be informed that the data shown in this PDF Document is generated from our Online Catalog. Please find the complete data in the user's documentation. Our General Terms of Use for Downloads are valid (<http://download.phoenixcontact.com>)



Sensor/actuator box, Connection method: QUICKON, 0.14 mm<sup>2</sup> ... 0.34 mm<sup>2</sup>, Number of slots: 6, Number of positions: 3, Slot assignment: Single, Status indication: No, Universal; Master cable connection: Pluggable screw connection 180°, Shielding: No

### Product Features

- ✓ Safety in the field, thanks to molded housing and high degree of protection
- ✓ Flexible, distributed bundling of signals in one master cable
- ✓ Innovative and time-saving assembly with insulation displacement connection
- ✓ Flexible: distributor box with connector hood for on-site assembly



### Key commercial data

|                                      |           |
|--------------------------------------|-----------|
| Packing unit                         | 1 PCE     |
| Weight per Piece (excluding packing) | 298.0 GRM |
| Custom tariff number                 | 85366990  |
| Country of origin                    | Germany   |

### Technical data

#### General

|  |                                   |
|--|-----------------------------------|
| Rated voltage                            | 48 V                              |
|  | 60 V DC                           |
| Current carrying capacity per I/O signal | 2 A                               |
| Current carrying capacity per slot       | 4 A                               |
| Total rated current                      | 10 A                              |
|  | 2x 8 A (For electrical isolation) |
| Number of positions                      | 3                                 |
| Number of slots                          | 6                                 |
| Inflammability class according to UL 94  | V0                                |
| Sensor/actuator connection system        | QUICKON                           |

# Sensor/actuator box - SACB- 6/3-C QO-0,34 - 1548367

## Technical data

### Ambient conditions

|                                 |                  |
|---------------------------------|------------------|
| Degree of protection            | IP65             |
|                                 | IP67             |
|                                 | IP69K            |
| Ambient temperature (operation) | -30 °C ... 80 °C |

### Master cable data/connection data

|   |                            |
|---|----------------------------|
| Connection method                         | Pluggable screw connection |
| Conductor cross section min. (signal)     | 0.14 mm <sup>2</sup>       |
| Conductor cross section max. (signal)     | 1.5 mm <sup>2</sup>        |
| Conductor cross section AWG min. (signal) | 26                         |
| Conductor cross section AWG max. (signal) | 16                         |
| Stripping length (signal)                 | 7 mm                       |
| Conductor cross section min. (energy)     | 0.14 mm <sup>2</sup>       |
| Conductor cross section max. (energy)     | 1.5 mm <sup>2</sup>        |
| Conductor cross section AWG min. (energy) | 26                         |
| Conductor cross section AWG max. (energy) | 16                         |
| External cable diameter min.              | 7 mm                       |
| External cable diameter max.              | 12 mm                      |
| Stripping length                          | 50 mm (Master cable)       |
| Tightening torque, cover screw            | 0.35 Nm                    |
| Tightening torque, union nut              | 2.5 Nm                     |

### Conductor data

|   |                      |
|---|----------------------|
| Structure of individual litz in acc. with VDE 0295 / smallest wire diameter | Class 2-6            |
| Wire insulation material  | PVC/PE/PP            |
| Wire diameter including insulation  | 0.7 mm ... 1.3 mm    |
| Minimum external conductor diameter   | 3.5 mm               |
| Maximum external conductor diameter   | 6 mm                 |
| Tightening torque, union nut  | 2 Nm                 |
| Wrench size, union nut  | 13 mm                |
| Conductor cross section stranded min.                                       | 0.14 mm <sup>2</sup> |
| Conductor cross section stranded max.                                       | 0.34 mm <sup>2</sup> |
| Conductor cross section AWG/kcmil min.                                      | 26                   |
| Conductor cross section AWG/kcmil max.                                      | 22                   |

### Insulation material

|                               |              |
|-------------------------------|--------------|
| Housing material              | PBT          |
| Material of the moulding mass | PUR          |
| Contact material              | Steel/copper |

# Sensor/actuator box - SACB- 6/3-C QO-0,34 - 1548367

## Technical data

### Insulation material

|  |             |
|--|-------------|
| Contact surface material                                 | Sn          |
| Material of contact, master cable side                   | CU alloy    |
| Material of contact surface, master cable side           | Gold-plated |
| Material of the contact carrier on the master cable side | PA 66 V0    |

### Pin assignment

|  |                                   |
|--|-----------------------------------|
| Slot/position = Wire color or connection | 1 / 4 (A) = 1 / 4                 |
|  | 2 / 4 (A) = 2 / 4                 |
|  | 3 / 4 (A) = 3 / 4                 |
|  | 4 / 4 (A) = 4 / 4                 |
|  | 5 / 4 (A) = 5 / 4                 |
|  | 6 / 4 (A) = 6 / 4                 |
|  | 1-6 / 1 (+ 48 V) = U <sub>N</sub> |
|  | 1-6 / 3 (0 V) = 0 V               |

## Classifications

### eCl@ss

|            |          |
|------------|----------|
| eCl@ss 4.0 | 27250313 |
| eCl@ss 4.1 | 27250313 |
| eCl@ss 5.0 | 27143423 |
| eCl@ss 5.1 | 27143423 |
| eCl@ss 6.0 | 27143423 |
| eCl@ss 7.0 | 27449001 |
| eCl@ss 8.0 | 27449001 |

### ETIM

|          |          |
|----------|----------|
| ETIM 3.0 | EC001856 |
| ETIM 4.0 | EC002585 |
| ETIM 5.0 | EC002585 |

### UNSPSC

|               |          |
|---------------|----------|
| UNSPSC 6.01   | 31261501 |
| UNSPSC 7.0901 | 31261501 |
| UNSPSC 11     | 31261501 |
| UNSPSC 12.01  | 31261501 |
| UNSPSC 13.2   | 31261501 |

# Sensor/actuator box - SACB- 6/3-C QO-0,34 - 1548367

## Approvals

Approvals

---

Approvals

UL Recognized / cUL Recognized / GOST / cULus Recognized

---

Ex Approvals

---

Approvals submitted

---

## Approval details

|  |      |
|--|------|
| UL Recognized  |      |
|  |      |
| Nominal voltage UN   | 48 V |

|  |      |
|--|------|
| cUL Recognized  |      |
|  |      |
| Nominal voltage UN   | 48 V |

|  |  |
|--|--|
| GOST  |  |
|--|--|

|  |  |
|--|--|
| cULus Recognized  |  |
|--|--|

## Accessories

Accessories

Cable by the meter

## Sensor/actuator box - SACB- 6/3-C QO-0,34 - 1548367

### Accessories

Master cable ring - SACB- 6X0,34/2X0,75-50 PUR - 1517589



Master cable for sensor/actuator boxes, without PE conductor, unshielded, material PUR/PVC, 8-pos., 6 x 0.34 mm<sup>2</sup> and 2 x 0.75 mm<sup>2</sup>, length: 50 m

---

### Connector hood without master cable

Connector hood - SACB-C-H180 8/4 QO-0,34 - 1560235



Connector hood, For use in Sensor/actuator box, Connection method: QUICKON, Number of slots: 8, Slot assignment: Double, Status indication: No; Master cable connection: Pluggable screw connection 180°, Shielding: No

---

### Device marking

Contact marker – zack marker strip - SS-ZB 17,5 WH - 0804963



Contact marker – zack marker strip, Strip, white, Unlabeled, Can be labeled with: Plotter, Mounting type: Snap into flat marker groove, Lettering field: 17.5 x 8 mm

---

### Pressure nut

Connector - QO-SET - 1548626



QUICKON set for replacement purposes, consisting of splice ring, pressure nut and line seal

---

### Protective cap

## Sensor/actuator box - SACB- 6/3-C QO-0,34 - 1548367

### Accessories

Filler plugs - Q-PROT 9/11 - 1670235



Closing cap for Pg9/Pg11 to close unoccupied connections

---

### Screwdriver tools

Philips screwdriver - SZK PZ1 VDE - 1206450



Screwdriver, PZ crosshead, VDE insulated, size: PZ 1 x 80 mm, 2-component grip, with non-slip grip

---

Tool - SAC BIT QUICKON-W13 - 1212033



Nut for assembling QUICKON pressure nuts with 13 mm wrench size, for 4 mm hexagonal drive

---

### Torque tool

Torque screwdriver - TSD 20 SAC - 1212020



Torque screwdriver, with preset torque of 2.0 Nm and 4 mm hexagonal drive for the pressure nut of the fast connection

---

### Drawings

# Sensor/actuator box - SACB- 6/3-C QO-0,34 - 1548367

Schematic diagram

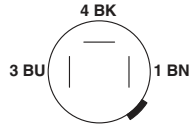

QUICKON connection, 3-pos.

Schematic diagram

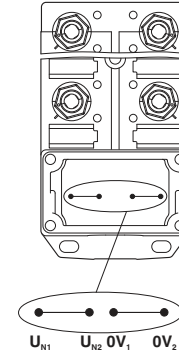

Potential  $U_{N1}$  and  $U_{N2}$  bridged. Potential assignment:  $U_{N1} = U_{N2} =$  slots 1,2,3,4,5,6.

Schematic diagram

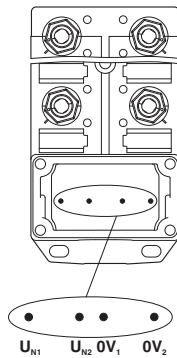

Electrically isolated. Potential assignment:  $U_{N1} =$  slots 1,3,5 and  $U_{N2} =$  slots 2,4,6.

Dimensioned drawing

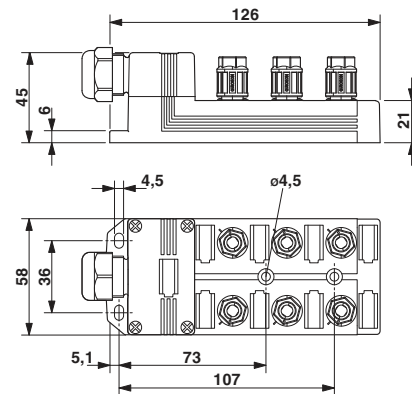

Circuit diagram

