



Ultrasonic sensor

UB1000-18GM75-E5-V15

- Switching output
- 5 different output functions can be set
- Selectable sound lobe width
- Program input
- Synchronization options
- Deactivation option
- Temperature compensation
- Very small unusable area

Single head system



Dimensions

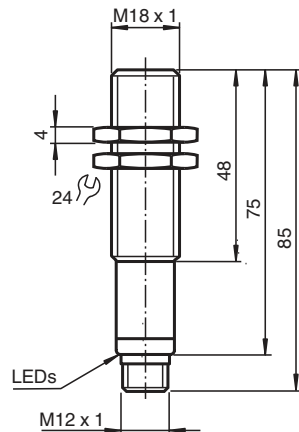

Technical Data

General specifications

Sensing range	70 ... 1000 mm
Adjustment range	90 ... 1000 mm
Dead band	0 ... 70 mm
Standard target plate	100 mm x 100 mm
Transducer frequency	approx. 255 kHz
Response delay	approx. 125 ms

Indicators/operating means

LED yellow	indication of the switching state flashing: program function object detected
------------	---

Release date: 2023-02-15 Date of issue: 2023-02-15 Filename: 204530_eng.pdf

Refer to "General Notes Relating to Pepperl+Fuchs Product Information".

Pepperl+Fuchs Group
www.pepperl-fuchs.com

USA: +1 330 486 0001
fa-info@us.pepperl-fuchs.com

Germany: +49 621 776 1111
fa-info@de.pepperl-fuchs.com

Singapore: +65 6779 9091
fa-info@sg.pepperl-fuchs.com

PEPPERL+FUCHS

Technical Data

LED red	solid red: Error red, flashing: program function, object not detected	
Electrical specifications		
Operating voltage	U_B	10 ... 30 V DC , ripple 10 % _{SS}
No-load supply current	I_0	≤ 50 mA
Input/Output		
Synchronization	1 synchronous connection, bi-directional 0-level: $-U_B \dots +1$ V 1-level: $+4$ V... $+U_B$ input impedance: > 12 kΩ synchronization pulse: ≥ 100 μs, synchronization interpulse period: ≥ 2 ms	
Synchronization frequency		
Common mode operation	max. 40 Hz	
Multiplex operation	≤ 40 Hz / n, n = number of sensors, n ≤ 5	
Input		
Input type	1 program input, operating range 1: $-U_B \dots +1$ V, operating range 2: $+4$ V ... $+U_B$ input impedance: > 4.7 kΩ; program pulse: ≥ 1 s	
Output		
Output type	1 switch output PNP Normally open/closed , programmable	
Rated operating current	I_e	200 mA , short-circuit/overload protected
Voltage drop	U_d	≤ 3 V
Repeat accuracy	≤ 1 %	
Switching frequency	f	max. 3 Hz
Range hysteresis	H	1 % of the set operating distance
Temperature influence	± 1.5 % of full-scale value	
Compliance with standards and directives		
Standard conformity		
Standards	EN IEC 60947-5-2:2020 IEC 60947-5-2:2019	
Approvals and certificates		
UL approval	cULus Listed, Class 2 Power Source	
CCC approval	CCC approval / marking not required for products rated ≤36 V	
Ambient conditions		
Ambient temperature	-25 ... 70 °C (-13 ... 158 °F)	
Storage temperature	-40 ... 85 °C (-40 ... 185 °F)	
Mechanical specifications		
Connection type	Connector plug M12 x 1 , 5-pin	
Housing diameter	18 mm	
Degree of protection	IP67	
Material		
Housing	brass, nickel-plated	
Transducer	epoxy resin/hollow glass sphere mixture; foam polyurethane, cover PBT	
Mass	60 g	
Factory settings		
Output	Switch point A1: 90 mm Switch point A2: 1000 mm output function: Window mode output behavior: NO contact	
Beam width	wide	

Connection

Standard symbol/Connections:
(version E5, pnp)

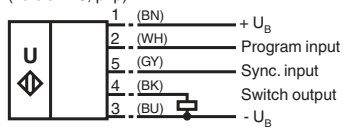

Wire colors in accordance with EN 60947-5-2.

Connection Assignment

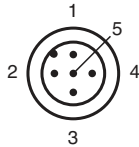

Wire colors in accordance with EN 60947-5-2

1	BN	(brown)
2	WH	(white)
3	BU	(blue)
4	BK	(black)
5	GY	(gray)

Characteristic Curve

Characteristic response curve

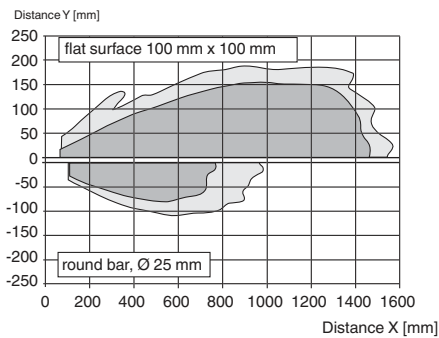







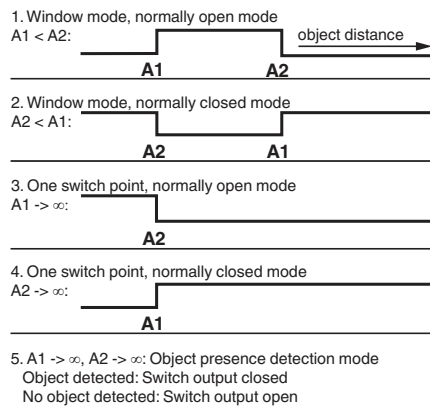

Release date: 2023-02-15 Date of issue: 2023-02-15 Filename: 204530_eng.pdf

Characteristic Curve

Programmable output modes



Accessories

	UB-PROG2	Programming unit
	OMH-04	Mounting aid for round steel \varnothing 12 mm or sheet 1.5 mm ... 3 mm
	BF 18	Mounting flange, 18 mm
	BF 18-F	Plastic mounting adapter, 18 mm
	BF 5-30	Universal mounting bracket for cylindrical sensors with a diameter of 5 ... 30 mm
	UVW90-K18	Ultrasonic -deflector
	M18K-VE	Plastic nuts with centering ring for the vibration-free mounting of cylindrical sensors
	V15-G-2M-PVC	Female cordset single-ended M12 straight A-coded, 5-pin, PVC cable grey
	V15-W-2M-PVC	Female cordset single-ended M12 angled A-coded, 5-pin, PVC cable grey

Release date: 2023-02-15 Date of issue: 2023-02-15 Filename: 204530_eng.pdf

Programming

Programming procedure

The sensor features a programmable switch output with two programmable switch points. Programming the switch points and the operating mode is done by applying the supply voltage $-U_B$ or $+U_B$ to the Teach-In input. The supply voltage must be applied to the Teach-In input for at least 1 s. LEDs indicate whether the sensor has recognized the target during the programming procedure.

Note:

Switching points may only be specified directly after Power on. A time lock secures the adjusted switching points against unintended modification 5 minutes after Power on. To modify the switching points later, the user may specify the desired values only after a new Power On.

Note:

If a programming adapter UB-PROG2 is used for the programming procedure, button A1 is assigned to $-U_B$ and button A2 is assigned to $+U_B$.

Programming of the switch output

Window Modes

Normally open (NO) output

1. Place the target at the near end of the desired switch window
2. Program the window boundary by applying $-U_B$ to the Teach-In input (yellow LED flashes)
3. Disconnect the Teach-In input from $-U_B$ to save the switch point
4. Place the target at the far end of the desired switch window
5. Program the window boundary by applying $+U_B$ to the Teach-In input (yellow LED flashes)
6. Disconnect the Teach-In input from $+U_B$ to save the switch point

Normally closed (NC) output

1. Place the target at the near end of the desired switch window
2. Program the window boundary by applying $+U_B$ to the Teach-In input (yellow LED flashes)
3. Disconnect the Teach-In input from $+U_B$ to save the switch point
4. Place the target at the far end of the desired switch window
5. Program the window boundary by applying $-U_B$ to the Teach-In input (yellow LED flashes)
6. Disconnect the Teach-In input from $-U_B$ to save the switch point

Switch Point Modes

Normally open (NO) output

1. Place the target at the desired switch point position
2. Program the switch point by applying $+U_B$ to the Teach-In input (yellow LED flashes)
3. Disconnect the Teach-In input from $+U_B$ to save the switch point
4. Cover the sensor face with hand or remove all objects from sensing range
5. Apply $-U_B$ to the Teach-In input (red LED flashes)
6. Disconnect the Teach-In input from $-U_B$ to save the setting

Normally closed (NC) output

1. Place the target at the desired switch point position
2. Program the switch point by applying $-U_B$ to the Teach-In input (yellow LED flashes)
3. Disconnect the Teach-In input from $-U_B$ to save the switch point
4. Cover the sensor face with hand or remove all objects from sensing range
5. Apply $+U_B$ to the Teach-In input (red LED flashes)
6. Disconnect the Teach-In input from $+U_B$ to save the setting

Object Detection Mode

1. Cover the sensor face with hand or remove all objects from sensing range
2. Apply $-U_B$ to the Teach-In input (red LED flashes)
3. Disconnect the Teach-In input from $-U_B$ to save the setting
4. Apply $+U_B$ to the Teach-In input (red LED flashes)
5. Disconnect the Teach-In input from $+U_B$ to save the setting

Adjusting the sound cone characteristics:

The ultrasonic sensor enables two different shapes of the sound cone, a wide angle sound cone and a small angle sound cone.

1. Small angle sound cone

- switch off the power supply
- connect the Teach-In input wire to $-U_B$
- switch on the power supply
- the red LED flashes once with a pause before the next.
- yellow LED: permanently on: indicates the presence of an object or disturbing object within the sensing range
- disconnect the Teach-In input wire from $-U_B$ and the changing is saved

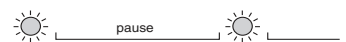

2. Wide angle sound cone

- switch off the power supply
- connect the Teach-In input wire with $+U_B$

- switch on the power supply
- the red LED double-flashes with a long pause before the next.
- yellow LED: permanently on: indicates an object or disturbing object within the sensing range
- disconnect the Teach-In input wire from +U_B and the changing is saved



Factory Setting

Factory settings

See technical data.

Indication

The sensor provides LEDs to indicate various conditions.

	Red LED	Yellow LED
During Normal operation		
Proper operation	Off	Switching state remains in previous state
Interference (e.g. compressed air)	On	
During sensor programming		
Object detected	Off	Flashes
No object detected	Flashes	Off
Object uncertain (programming invalid)	On	Off

Commissioning

Synchronization

This sensor features a synchronization input for suppressing ultrasonic mutual interference ("cross talk"). If this input is not connected, the sensor will operate using internally generated clock pulses. It can be synchronized by applying an external square wave. The pulse duration must be $\geq 100 \mu s$. Each falling edge of the synchronization pulse triggers transmission of a single ultrasonic pulse. If the synchronization signal remains low for ≥ 1 second, the sensor will revert to normal operating mode. Normal operating mode can also be activated by opening the signal connection to the synchronization input (see note below).

If the synchronization input goes to a high level for > 1 second, the sensor will switch to standby mode. In this mode, the outputs will remain in the last valid output state.

Note:

If the option for synchronization is not used, the synchronization input has to be connected to ground (0 V) or the sensor must be operated via a V1 cordset (4-pin).

The synchronization function cannot be activated during programming mode and vice versa.

The following synchronization modes are possible:

1. Several sensors (max. number see technical data) can be synchronized together by interconnecting their respective synchronization inputs. In this case, each sensor alternately transmits ultrasonic pulses in a self multiplexing mode. No two sensors will transmit pulses at the same time (see note below).
2. Multiple sensors can be controlled by the same external synchronization signal. In this mode the sensors are triggered in parallel and are synchronized by a common external synchronization pulse.
3. A separate synchronization pulse can be sent to each individual sensor. In this mode the sensors operate in external multiplex mode (see note below).
4. A high level (+U_B) on the synchronization input switches the sensor to standby mode.

Note:

Sensor response times will increase proportionally to the number of sensors that are in the synchronization string. This is a result of the multiplexing of the ultrasonic transmit and receive signal and the resulting increase in the measurement cycle time.

Installation Conditions

If the sensor is installed at places, where the environment temperature can fall below 0 °C, for the sensors fixation, one of the mounting flanges BF18, BF18-F or BF 5-30 must be used.

In case of direct mounting of the sensor in a through hole using the steel nuts, it has to be fixed at the middle of the housing thread. If a fixation at the front end of the threaded housing is required, plastic nuts with centering ring (accessories) must be used.

Release date: 2023-02-15 Date of issue: 2023-02-15 Filename: 204530_eng.pdf