

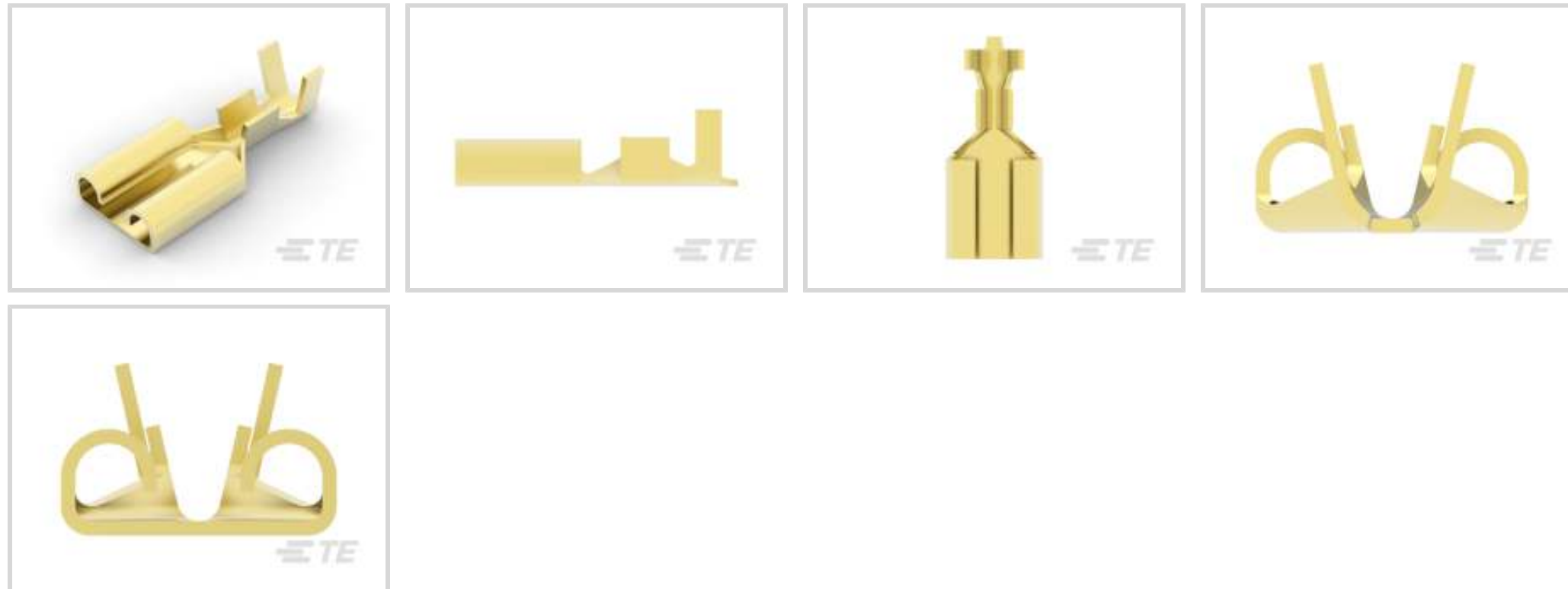

Terminals & Splices > Quick Disconnects



Quick Disconnect Terminal Type: **Receptacle**

Wire Size: .51 – 1.03 mm²

Mating Tab Width: 6.35 mm [.25 in]

Mating Tab Thickness: .81 mm [.032 in]

Features

Product Type Features

Insertion Force	Normal
-----------------	--------

Configuration Features

Compatible With Wire & Cable Type	Discrete Wire
-----------------------------------	---------------

Contact Features

Quick Disconnect Terminal Type	Receptacle
Mating Tab Width	6.35 mm [.25 in]
Mating Tab Thickness	.81 mm [.032 in]
Terminal Orientation	Straight
Contact Base Material	Brass
Terminal Plating Material	Unplated
Crimp Type	F-Crimp
Barrel Type	Open

Termination Features

Product Terminates To	Wire & Cable
-----------------------	--------------



Mechanical Attachment

Wire Insulation Support	With
Mating Retention Type	Dimple

Dimensions

Terminal Material Thickness	.41 mm[.016 in]
Product Length	16.3 mm[.642 in]
Compatible Insulation Diameter Range	2.01 – 3.3 mm[.079 – .13 in]
Wire Size	.51 – 1.03 mm ²

Usage Conditions

Insulation Option	Uninsulated
-------------------	-------------

Industry Standards

Agency/Standard	UL
-----------------	----

Packaging Features

Packaging Quantity	10000
Packaging Method	Reel

Other

Line	Budget
------	--------

Product Compliance

[For compliance documentation, visit the product page on TE.com>](#)

EU RoHS Directive 2011/65/EU	Compliant
EU ELV Directive 2000/53/EC	Compliant
China RoHS 2 Directive MIIT Order No 32, 2016	No Restricted Materials Above Threshold
EU REACH Regulation (EC) No. 1907/2006	Current ECHA Candidate List: JUNE 2023 (235) Candidate List Declared Against: JUNE 2023 (235) Does not contain REACH SVHC
Halogen Content	Low Halogen - Br, Cl, F, I < 900 ppm per homogenous material. Also BFR/CFR/PVC Free
Solder Process Capability	Not applicable for solder process capability

Product Compliance Disclaimer

This information is provided based on reasonable inquiry of our suppliers and represents our current actual knowledge based on the information they provided. This information is subject to change. The part numbers that TE has identified as EU RoHS compliant have a maximum concentration of 0.1% by weight in homogenous materials for lead, hexavalent chromium, mercury, PBB, PBDE, DBP, BBP, DEHP, DIBP, and 0.01% for cadmium, or qualify for an exemption to these limits as defined in the Annexes of Directive 2011/65/EU (RoHS2). Finished electrical and electronic equipment products will be CE marked as required by Directive 2011/65/EU. Components may not be CE marked. Additionally, the part numbers that TE has identified as EU ELV compliant have a maximum concentration of 0.1% by weight in homogenous materials for lead, hexavalent chromium, and mercury, and 0.01% for cadmium, or qualify for an exemption to these limits as defined in the Annexes of Directive 2000/53/EC (ELV). Regarding the REACH Regulation, the information TE provides on SVHC in articles for this part number is based on the latest European Chemicals Agency (ECHA) 'Guidance on requirements for substances in articles' posted at this URL: <https://echa.europa.eu/guidance-documents/guidance-on-reach>

Compatible Parts



Also in the Series | FASTON 250

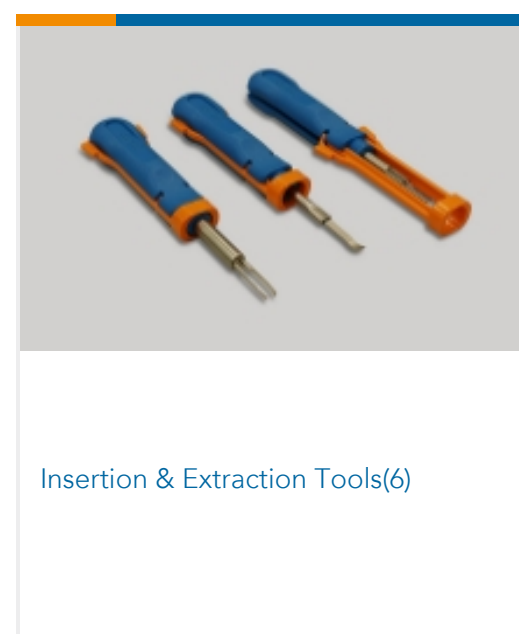
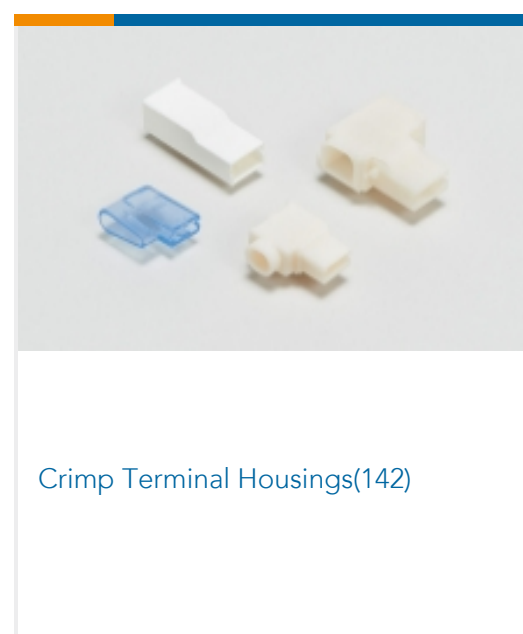
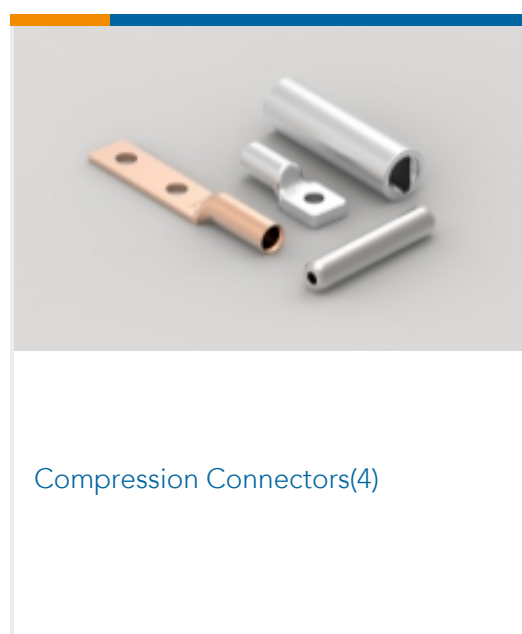



PCB Terminals(135)



Quick Disconnects(445)



Splices(4)

Customers Also Bought



TE Part #1-2112780-9
AMP MCP, SEALED CONNECTOR
HOUSING

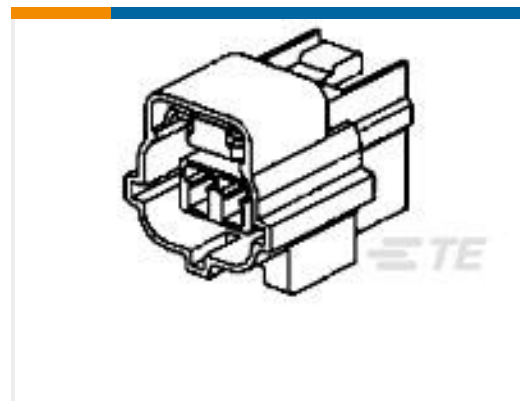

TE Part #881773-1
KIT ECONOSEAL J I P



TE Part #170002-5
SHUR PLUG 20-14 AWG 0.5 X 11.44
TPBR

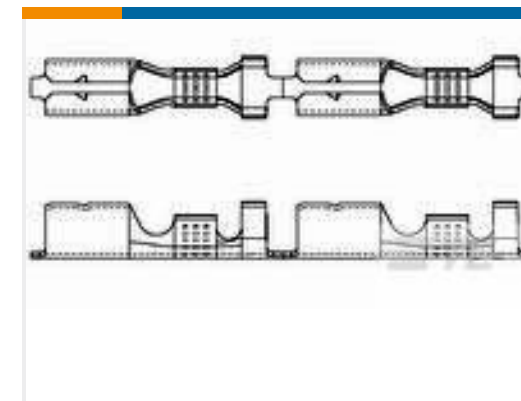

TE Part #626399-1
.140 SHUR PLUG REC.



TE Part #880622-1
TERMINAL REC., SPECIAL TAB

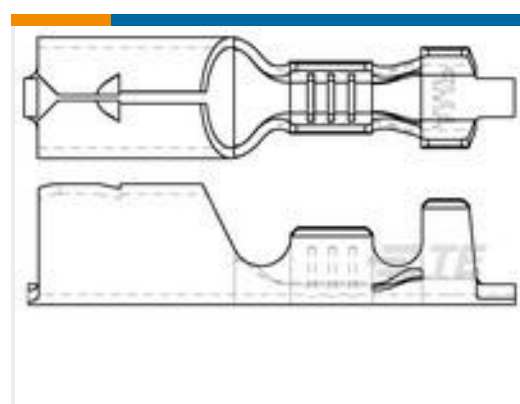

TE Part #881724-1
.156 DIA SHUR PWG R



TE Part #1989960-1
FASTIN-ON .312 FLAG REC. SPECIAL



TE Part #CV16686001
RNF-3000-NR553-0-17MM

Documents

Product Drawings

[.250 SERIES FASTON](#)

English

CAD Files

[3D PDF](#)

3D

Customer View Model

[ENG_CVM_CVM_880683-1_A1.2d_dxf.zip](#)

English

Customer View Model

[ENG_CVM_CVM_880683-1_A1.3d_igs.zip](#)

English

Customer View Model

[ENG_CVM_CVM_880683-1_A1.3d_stp.zip](#)

English

By downloading the CAD file I accept and agree to the [Terms and Conditions](#) of use.

880683-1

Quick Disconnects, Receptacle, 20 – 17 AWG Wire Size, .51 – 1.03 mm² Wire Size,
Mating Tab Width 6.35 mm [.25 in], Straight, Brass, FASTON 250

