



EVQ4315-R-01A

45V, 5A, Low- I_Q , Synchronous Step-Down Converter with Frequency Spread Spectrum Evaluation Board, AEC-Q100 Qualified

DESCRIPTION

The EVQ4315-R-01A evaluation board is designed to demonstrate the capabilities of the MPQ4315, a synchronous, step-down switching converter with a configurable frequency and integrated, internal high-side MOSFET (HS-FET) and low-side MOSFET (LS-FET). It provides up to 5A of highly efficient output current (I_{OUT}), with current mode control for fast loop response.

The wide 3.3V to 45V input voltage (V_{IN}) range accommodates a variety of step-down applications in automotive input environments. A 1.7 μ A quiescent current (I_Q) in shutdown mode allows the device to be used in battery-powered applications. High power conversion efficiency across a wide load range is achieved

by scaling down the switching frequency (f_{sw}) under light-load conditions to reduce the switching and gate driver losses.

Frequency foldback helps prevent inductor current runaway during start-up. Thermal shutdown provides reliable, fault-tolerant operation. High duty cycle and low-dropout (LDO) mode are provided for automotive cold crank conditions.

The EVQ4315-R-01A is fully assembled and tested. The MPQ4315 is available in a QFN-20 (4mmx4mm) wettable flank package, and is AEC-Q100 Grade 1 qualified.

PERFORMANCE SUMMARY

Specifications are at $T_A = 25^\circ\text{C}$, unless otherwise noted.

Parameter	Condition	Value
Input voltage (V_{IN}) range		3.3V to 45V
Output voltage (V_{OUT})	$V_{IN} = 3.3\text{V to }45\text{V}$, $I_{OUT} = 0\text{A to }5\text{A}$	$V_{OUT} = 3.3\text{V}$
Maximum output current (I_{OUT})	$V_{IN} = 3.3\text{V to }45\text{V}$	5A
Typical efficiency	$V_{IN} = 12\text{V}$, $V_{OUT} = 3.3\text{V}$, $I_{OUT} = 5\text{A}$	91.9%
Switching frequency (f_{sw})		410kHz

EVQ4315-R-01A EVALUATION BOARD



LxWxH (8.3cmx8.3cmx1.3cm)

Board Number	MPS IC Number
EVQ4315-R-01A	MPQ4315GRE-AEC1

QUICK START GUIDE

1. Preset the power supply (V_{IN}) between 3.3V and 45V. Electronic loads represent a negative impedance to the regulator, and setting a current too high triggers hiccup mode.
2. Turn off V_{IN} . If longer cables are used between the source and the evaluation board (>0.5m total), then install a damping capacitor at the input terminals, especially if $V_{IN} \geq 24V$.
3. Connect the power supply terminals to (see Figure 2 on page 3):
 - a. Positive (+): VEMI
 - b. Negative (-): GND
4. Connect the load terminals to (see Figure 2 on page 3):
 - a. Positive (+): VOUT
 - b. Negative (-): GND
5. After making the connections, turn on the power supply. The board should automatically start up.
6. To use the enable function, apply a digital input to the EN pin. Drive EN above 1V to turn the regulator on; drive EN below 0.85V to turn the regulator off.
7. The MPQ4315's oscillating (switching) frequency can be configured by an external frequency resistor (R3). R3 can be estimated based on the switching frequency (f_{sw}) vs. frequency resistance (R_{FREQ}) curve (see Figure 1).

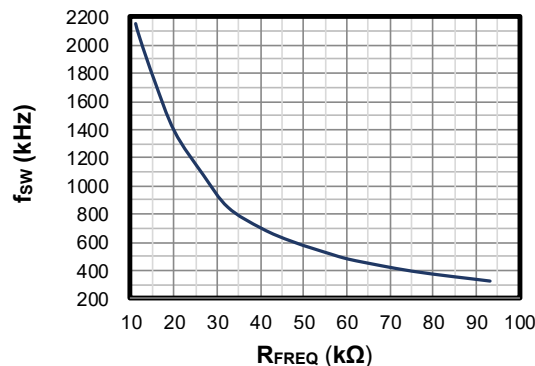

Figure 1: R3 Frequency Resistance

8. To use the sync function, apply a 350kHz to 1000kHz external clock to the SYNCIN pin to synchronize the internal clock's rising edge.
9. The output voltage (V_{OUT}) is set by the external resistor divider. If $R7 = 100k\Omega$, then $R8$ can be calculated using Equation (1):

$$R8 = \frac{R7}{\frac{V_{OUT}}{0.815V} - 1} \quad (1)$$

Table 1 shows the recommended $R7$ and $R8$ values for common output voltages.

Table 1: Resistor Selection for Output Voltages

V_{OUT} (V)	$R7$ (k Ω)	$R8$ (k Ω)
3.3	100 (1%)	32.4 (1%)
5	100 (1%)	19.1 (1%)

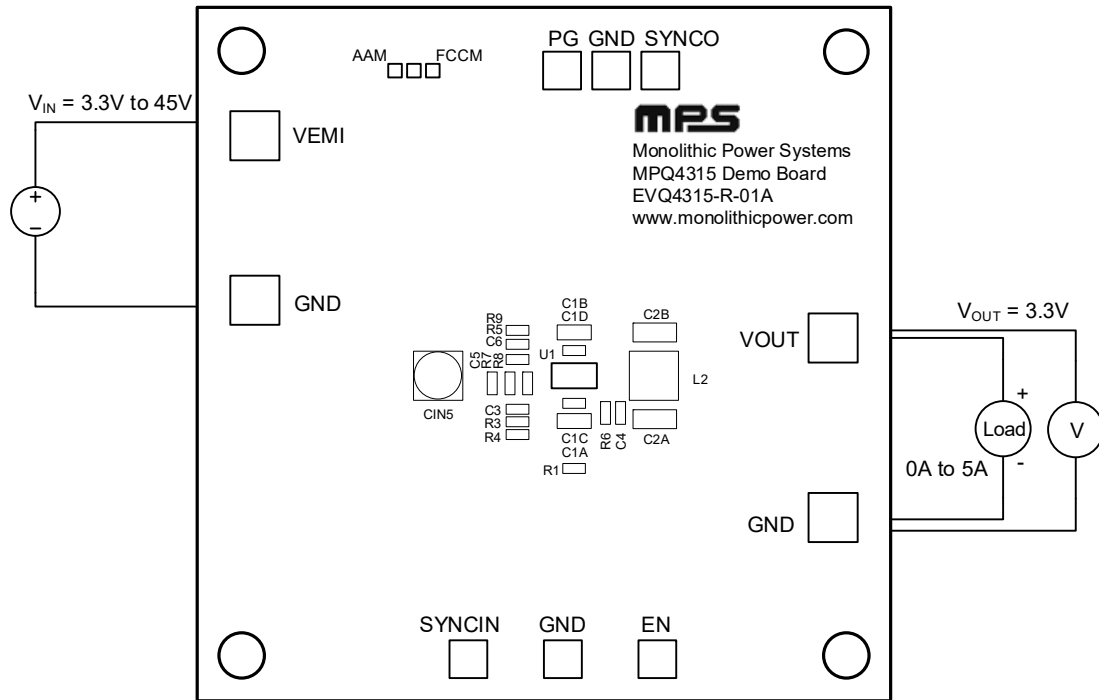

Figure 2: Measurement Equipment Set-Up

EVALUATION BOARD SCHEMATIC

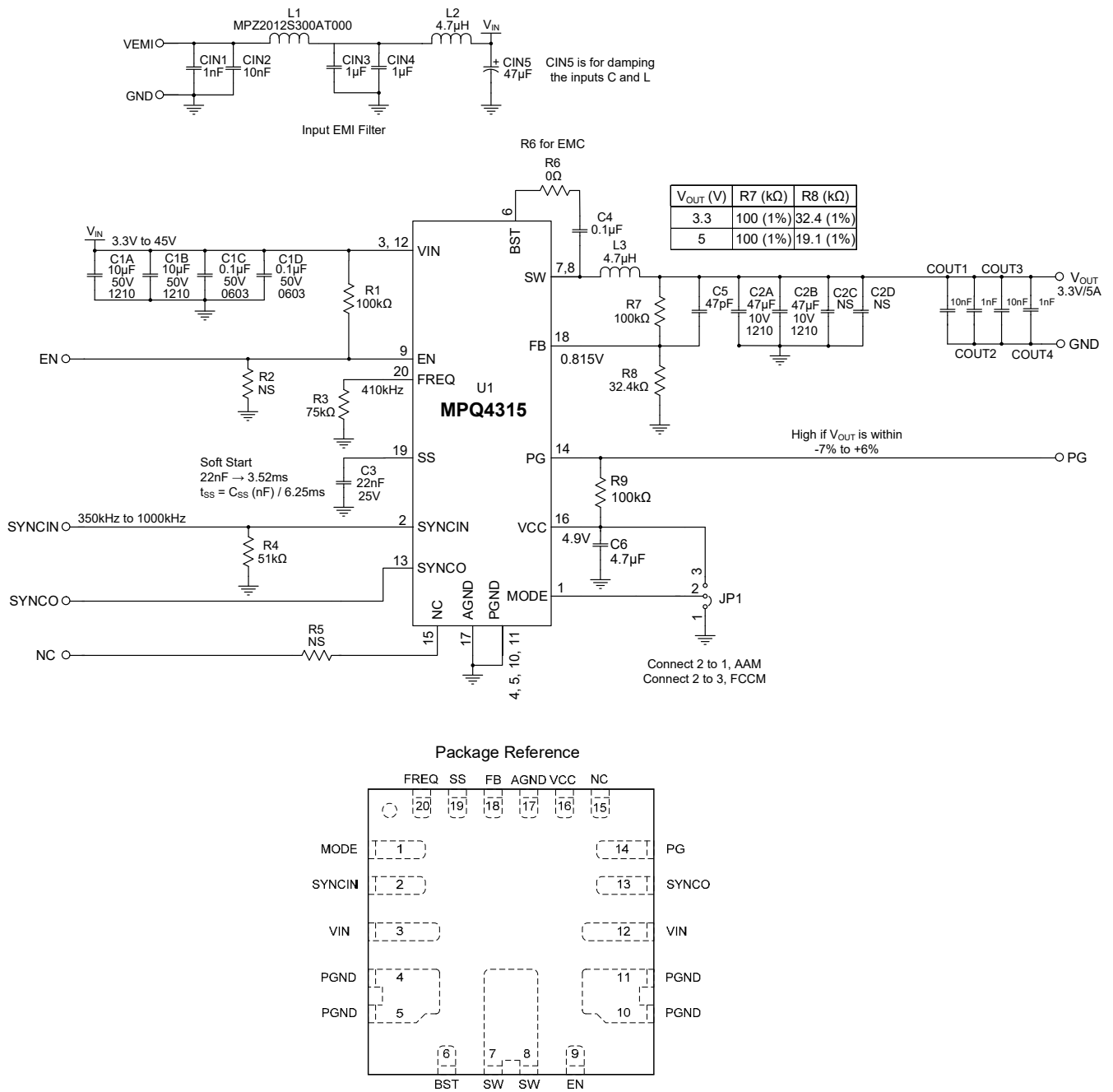

Figure 3: Evaluation Board Schematic and Package Reference

EVQ4315-R-01A BILL OF MATERIALS

Qty	Ref	Value	Description	Package	Manufacturer	Manufacturer PN
3	CIN1, COUT2, COUT4	1nF	Ceramic capacitor, 50V, X7R	0603	Murata	GRM216R71H102KA01
3	CIN2, COUT1, COUT3	10nF	Ceramic capacitor, 50V, X7R	0603	Murata	GRM188R71H103KA01D
2	CIN3, CIN4	1 μ F	Ceramic capacitor, 50V, X7R	1206	TDK	C3216X7R1H105K
1	CIN5	47 μ F	Aluminum capacitor, 63V	SMD	Panasonic	EEHZA1J470P
2	C1A, C1B	10 μ F	Ceramic capacitor, 50V, X7R	1210	Murata	GRM32ER71H106KA12L
2	C1C, C1D	0.1 μ F	Ceramic capacitor, 50V, X7R	0603	Murata	GCJ188R71H104KA12D
2	C2A, C2B	47 μ F	Ceramic capacitor, 10V, X5R	1210	Murata	GRM32ER61A476KE20L
1	C3	22nF	Ceramic capacitor, 25V, X7R	0603	Murata	GRM188R71E223JA01D
1	C4	0.1 μ F	Ceramic capacitor, 50V, X7R	0603	Murata	GRM188R71H104KA93D
1	C5	47pF	Ceramic capacitor, 50V, C0G	0603	TDK	C1608C0G1H470J
1	C6	4.7 μ F	Ceramic capacitor, 10V, X5R	0603	Murata	GRM188R61A475KE15D
1	L1	10m Ω	Magnetic bead, 6A	0805	TDK	MPZ2012S300AT000
1	L2	4.7 μ H	Inductor, 31.5m Ω , 6A	SMD	Cyntec	VCMT063T-4R7MN5T
1	L3	4.7 μ H	Inductor, 15.02m Ω , 12.1A	SMD	Coilcraft	XAL6060-472MEC
3	R1, R7, R9	100k Ω	Film resistor, 1%	0603	Yageo	RC0603FR-07100KL
1	R3	75k Ω	Film resistor, 1%	0603	Yageo	RC0603FR-0775KL
1	R4	51k Ω	Film resistor, 1%	0603	Yageo	RC0603FR-0751KL
1	R6	0 Ω	Film resistor, 1%	0603	Yageo	RC0603FR-070RL
1	R8	32.4k Ω	Film resistor, 1%	0603	Yageo	RC0603FR-0732K4L
4	C2C, C2D, R2, R5	NS				
1	JP1	2.54mm	Test pin, 3-pin	DIP	Any	
4	VEMI, GND, VOUT, GND	2mm	Golden test pin	DIP	Custom ⁽¹⁾	
7	SYNCIN, ICS, PG, SYNCO, EN, GND, GND	1mm	Golden test pin	DIP	Custom ⁽¹⁾	
1	U1	MPQ4315	45V/5A, step-down converter, AEC-Q100	QFN-20 (4mmx4mm)	MPS	MPQ4315GRE-AEC1

Note:

1) Contact an MPS FAE for more information regarding custom pins.

EVB TEST RESULTS

Performance curves and waveforms are tested on the evaluation board, $V_{IN} = 12V$, $V_{OUT} = 3.3V$, $C_{OUT} = 2 \times 47\mu F$, $L = 4.7\mu H$, $f_{SW} = 410kHz$, $T_A = 25^\circ C$, unless otherwise noted.

Input Current vs. Load Current

AAM mode, $V_{OUT} = 3.3V$

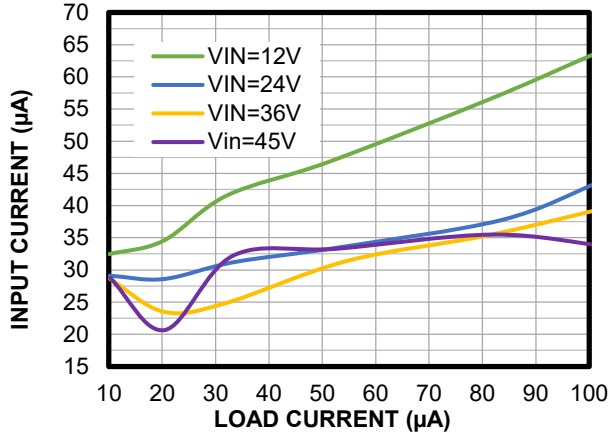

Input Current vs. Load Current

AAM mode, $V_{OUT} = 5V$

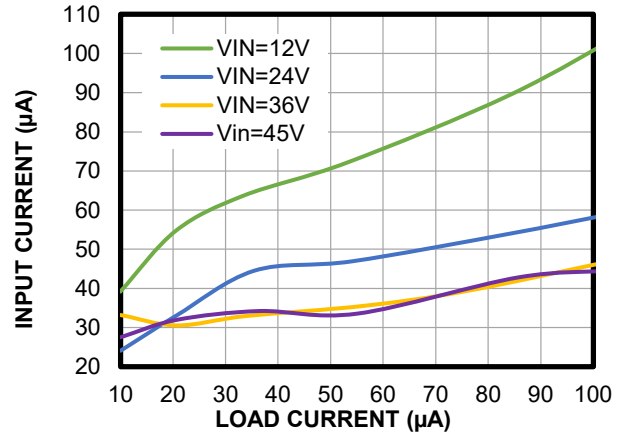

Efficiency vs. Load Current

AAM mode, $V_{OUT} = 3.3V$, 0.1mA to 10mA

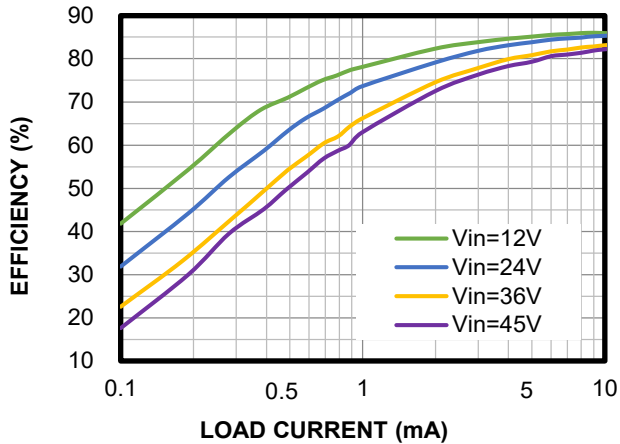

Efficiency vs. Load Current

AAM mode, $V_{OUT} = 3.3V$, 10mA to 1000mA

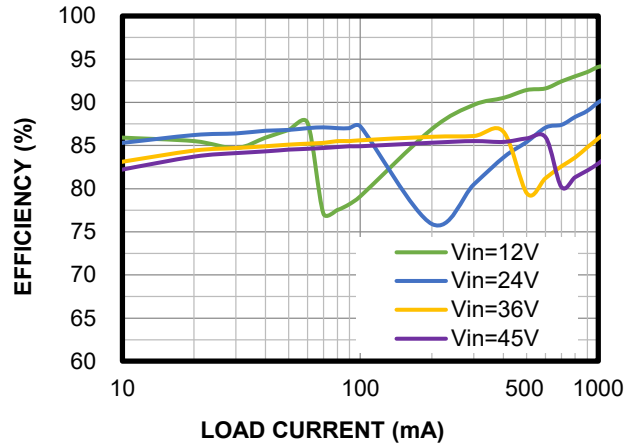

Efficiency vs. Load Current

AAM mode, $V_{OUT} = 3.3V$, 1A to 5A

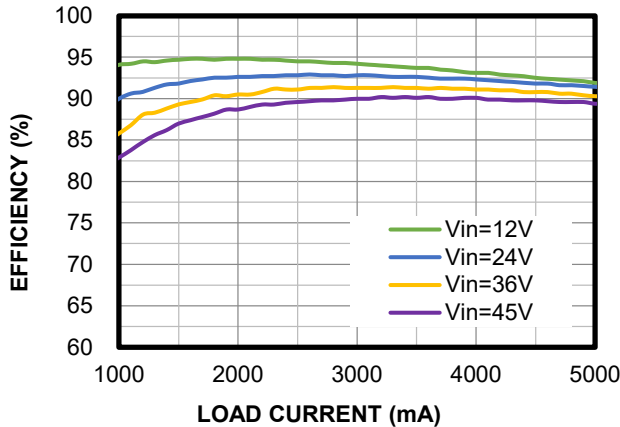

Efficiency vs. Load Current

FCCM, $V_{OUT} = 3.3V$, 0.1mA to 10mA

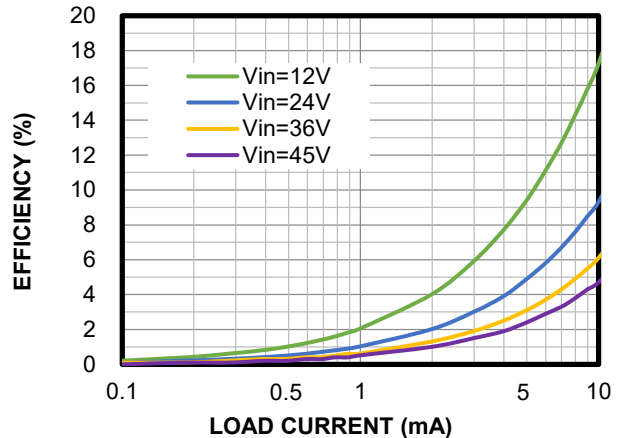

EVB TEST RESULTS (continued)

Performance curves and waveforms are tested on the evaluation board, $V_{IN} = 12V$, $V_{OUT} = 3.3V$, $C_{OUT} = 2 \times 47\mu F$, $L = 4.7\mu H$, $f_{SW} = 410kHz$, $T_A = 25^\circ C$, unless otherwise noted.

Efficiency vs. Load Current

FCCM, $V_{OUT} = 3.3V$, 10mA to 1000mA

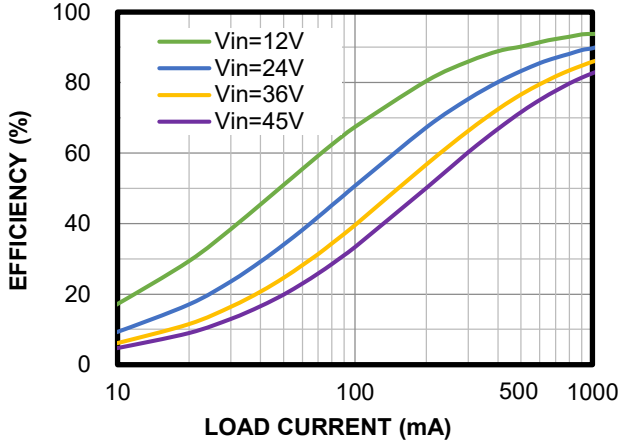

Efficiency vs. Load Current

FCCM, $V_{OUT} = 3.3V$, 1A to 5A

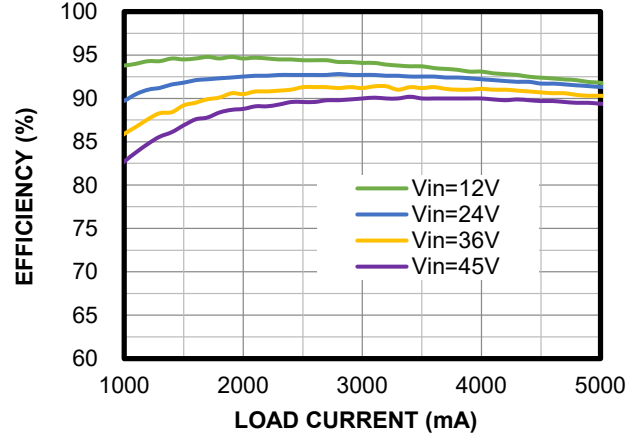

Efficiency vs. Load Current

AAM mode, $V_{OUT} = 5V$, 0.1mA to 10mA

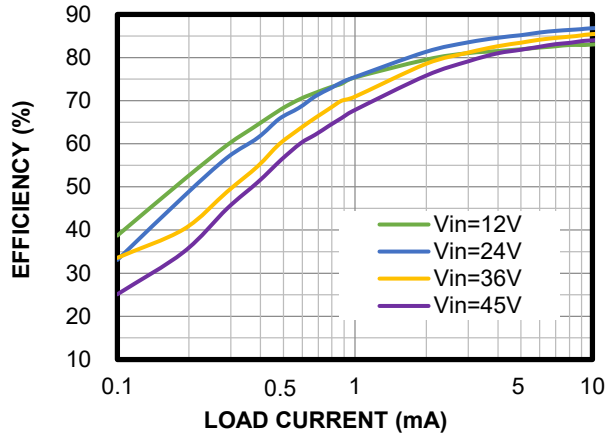

Efficiency vs. Load Current

AAM mode, $V_{OUT} = 5V$, 10mA to 1000mA

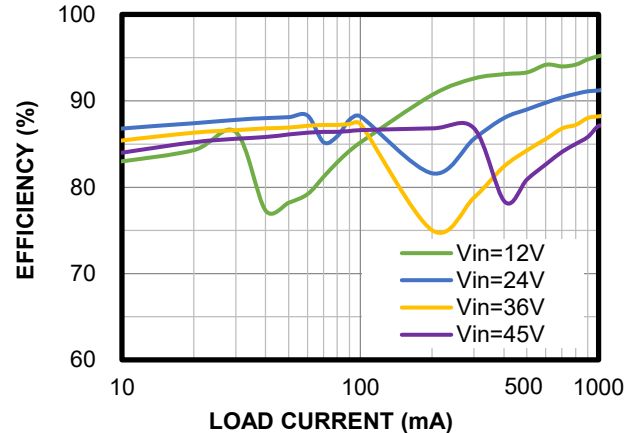

Efficiency vs. Load Current

AAM mode, $V_{OUT} = 5V$, 1A to 5A

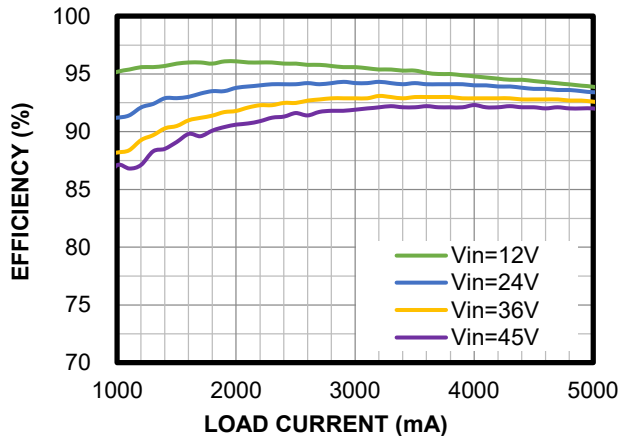

Efficiency vs. Load Current

FCCM, $V_{OUT} = 5V$, 0.1mA to 10mA

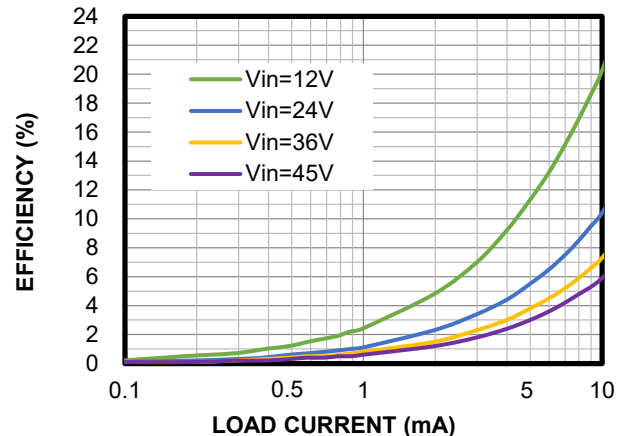

EVB TEST RESULTS (continued)

Performance curves and waveforms are tested on the evaluation board, $V_{IN} = 12V$, $V_{OUT} = 3.3V$, $C_{OUT} = 2 \times 47\mu F$, $L = 4.7\mu H$, $f_{SW} = 410kHz$, $T_A = 25^\circ C$, unless otherwise noted.

Efficiency vs. Load Current

FCCM, $V_{OUT} = 5V$, 10mA to 1000mA

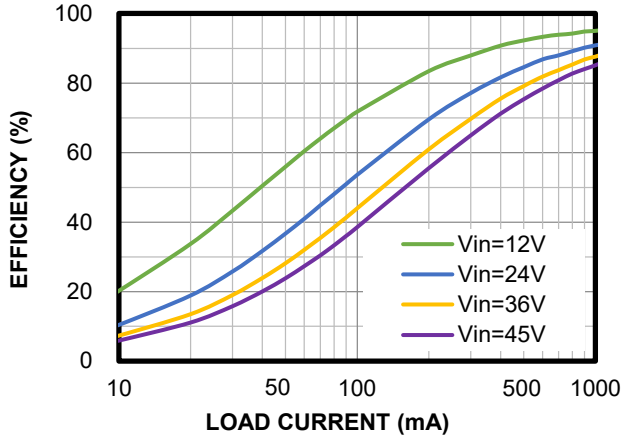

Efficiency vs. Load Current

FCCM, $V_{OUT} = 5V$, 1A to 5A

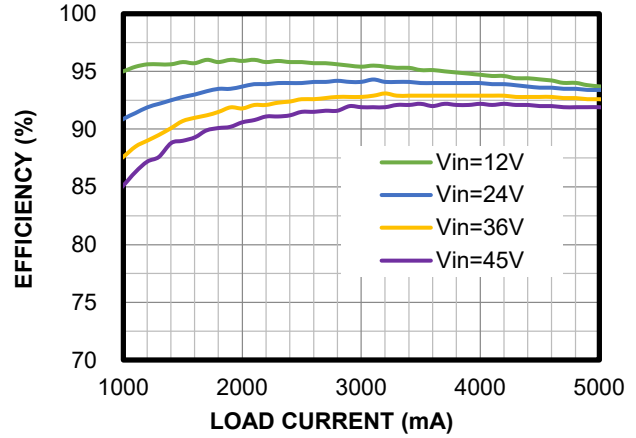

Load Regulation

$V_{OUT} = 3.3V$, AAM mode

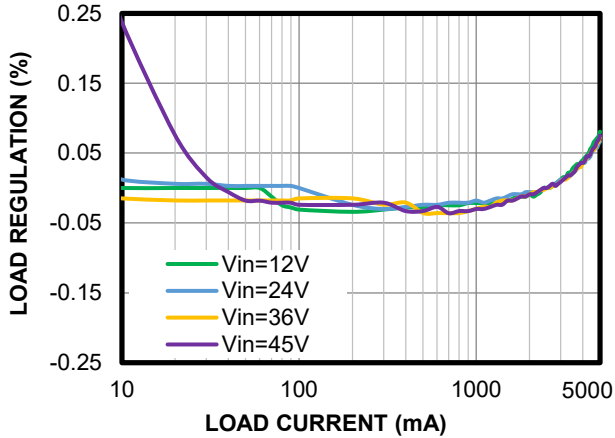

Load Regulation

$V_{OUT} = 3.3V$, FCCM

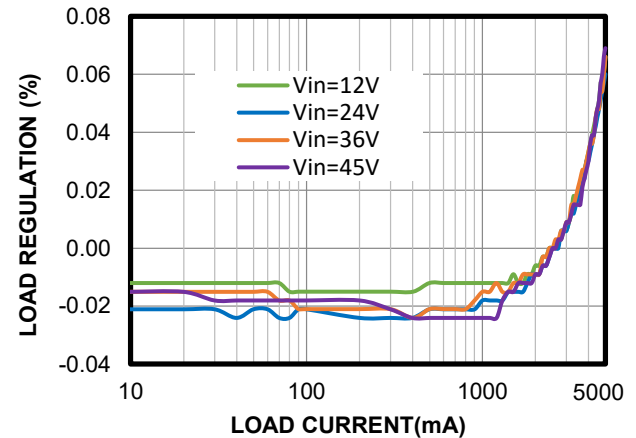

Line Regulation

$V_{OUT} = 3.3V$, AAM mode

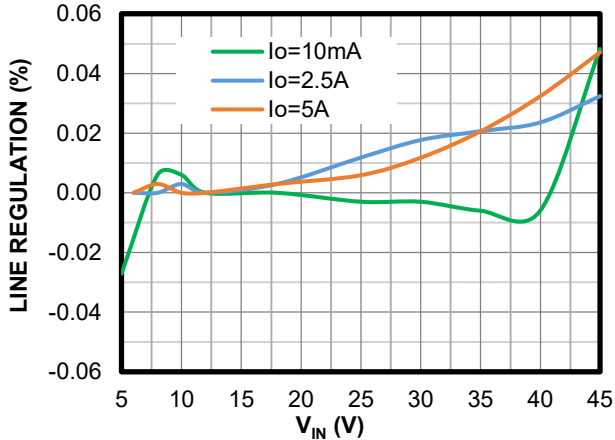

Line Regulation

$V_{OUT} = 3.3V$, FCCM

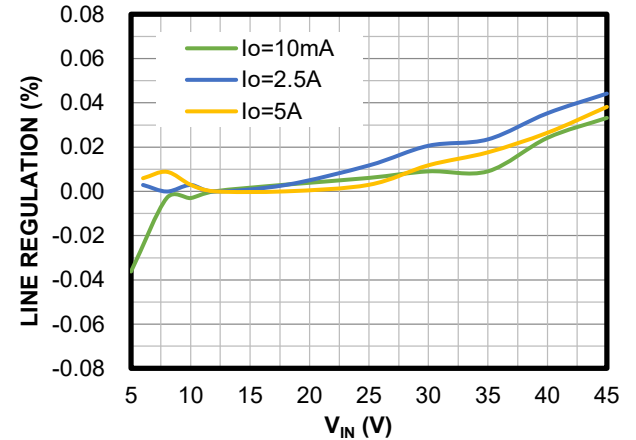

EVB TEST RESULTS (continued)

Performance curves and waveforms are tested on the evaluation board, $V_{IN} = 12V$, $V_{OUT} = 3.3V$, $C_{OUT} = 2 \times 47\mu F$, $L = 4.7\mu H$, $f_{SW} = 410kHz$, $T_A = 25^\circ C$, unless otherwise noted.

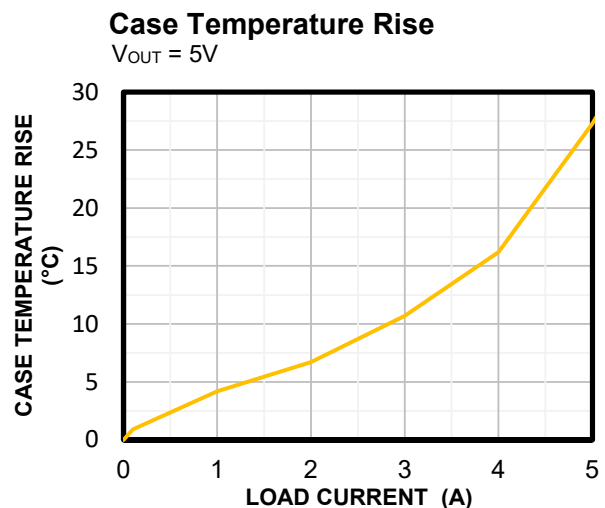
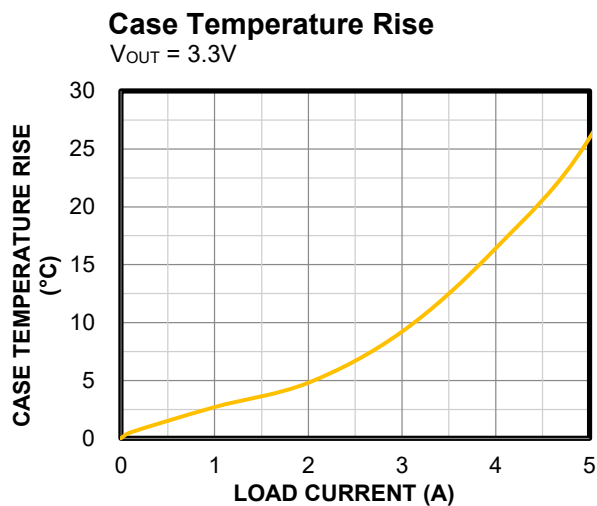
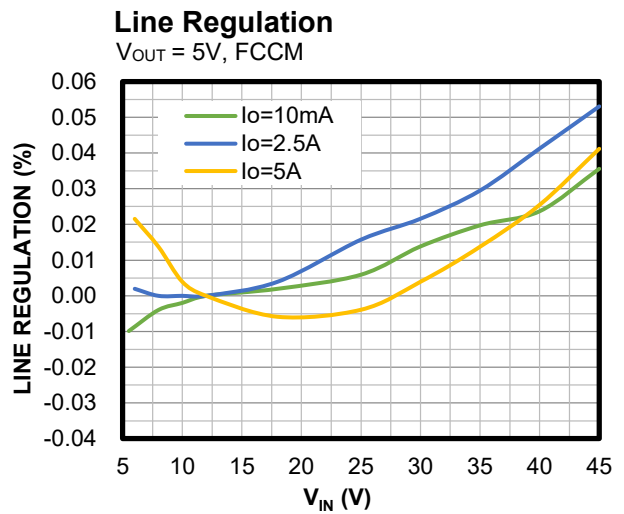
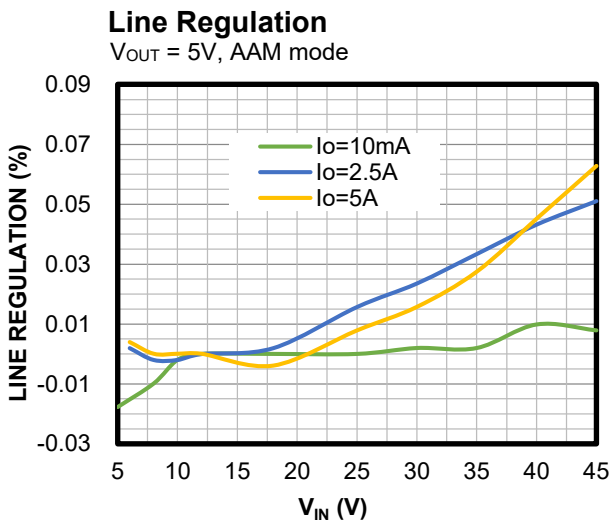
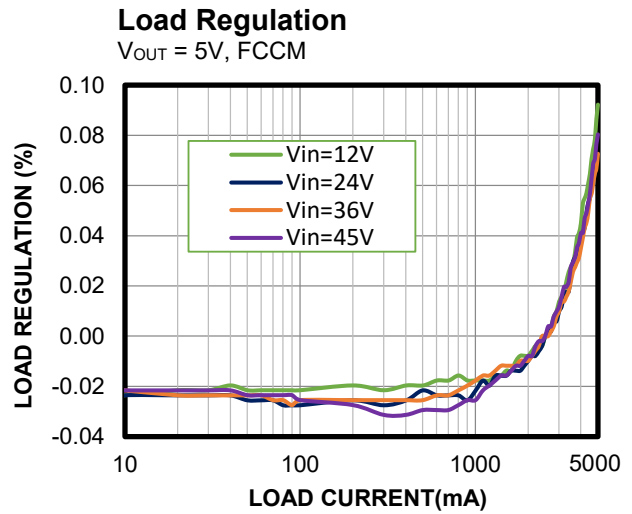
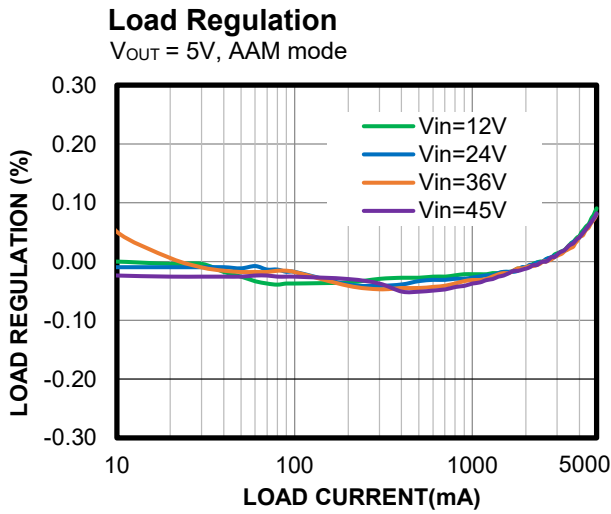

EVB TEST RESULTS *(continued)*

Performance curves and waveforms are tested on the evaluation board, $V_{IN} = 12V$, $V_{OUT} = 3.3V$, $C_{OUT} = 2 \times 47\mu F$, $L = 4.7\mu H$, $f_{SW} = 410kHz$, $T_A = 25^\circ C$, unless otherwise noted.

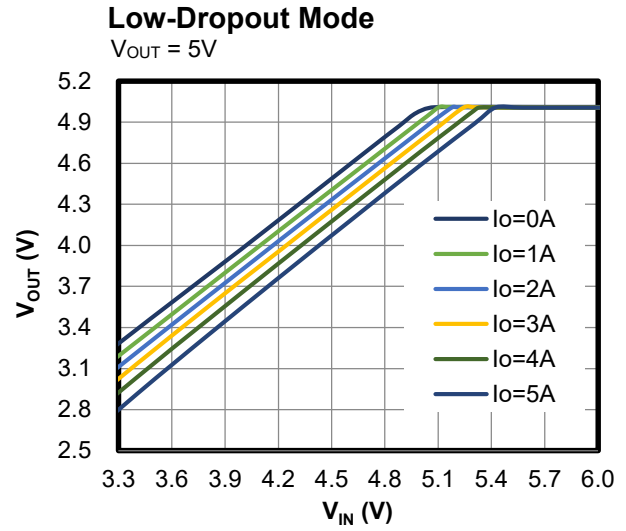
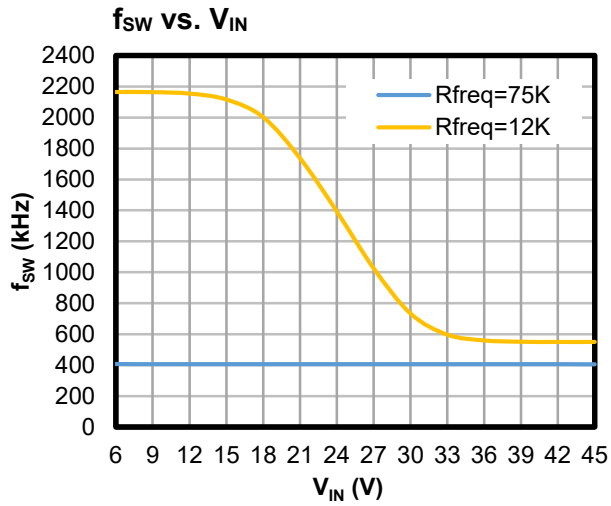

EVB TEST RESULTS (continued)

Performance curves and waveforms are tested on the evaluation board, $V_{IN} = 12V$, $V_{OUT} = 3.3V$, $C_{OUT} = 2 \times 47\mu F$, $L = 4.7\mu H$, $f_{SW} = 410kHz$, $T_A = 25^\circ C$, unless otherwise noted.

CISPR25 Class 5 Peak Conducted Emissions

150kHz to 108MHz

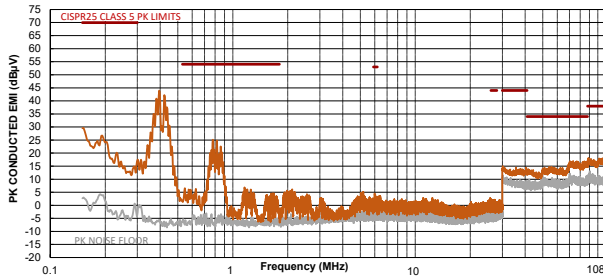

CISPR25 Class 5 Average Conducted Emissions

150kHz to 108MHz

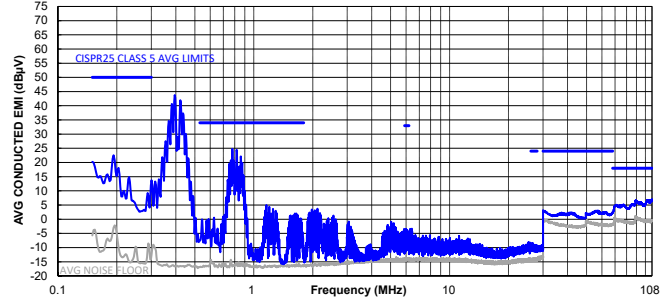

CISPR25 Class 5 Peak Radiated Emissions

150kHz to 30MHz

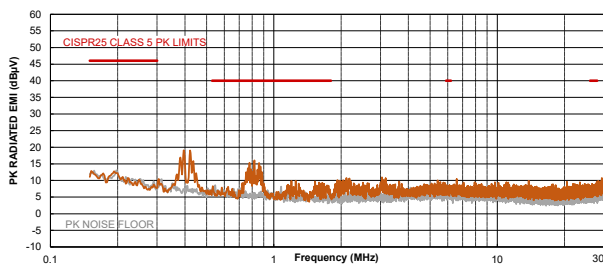

CISPR25 Class 5 Average Radiated Emissions

150kHz to 30MHz

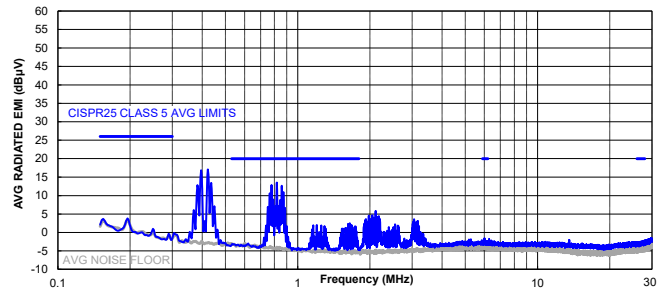

CISPR25 Class 5 Peak Radiated Emissions

Horizontal, 30MHz to 1GHz

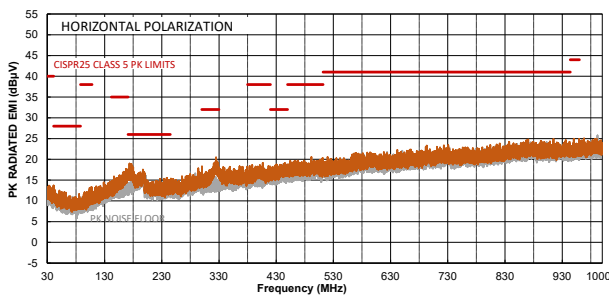

CISPR25 Class 5 Average Radiated Emissions

Horizontal, 30MHz to 1GHz

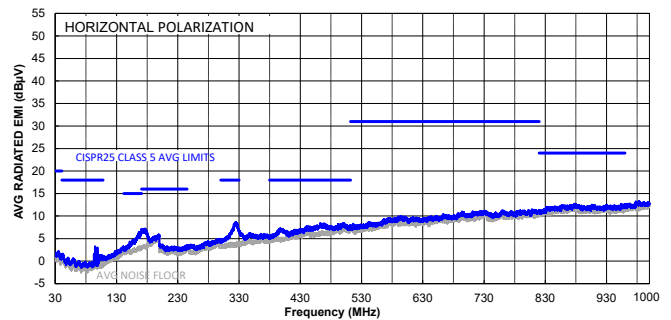

EVB TEST RESULTS *(continued)*

Performance curves and waveforms are tested on the evaluation board, $V_{IN} = 12V$, $V_{OUT} = 3.3V$, $C_{OUT} = 2 \times 47\mu F$, $L = 4.7\mu H$, $f_{SW} = 410kHz$, $T_A = 25^\circ C$, unless otherwise noted.

CISPR25 Class 5 Peak Radiated Emissions

Vertical, 30MHz to 1GHz

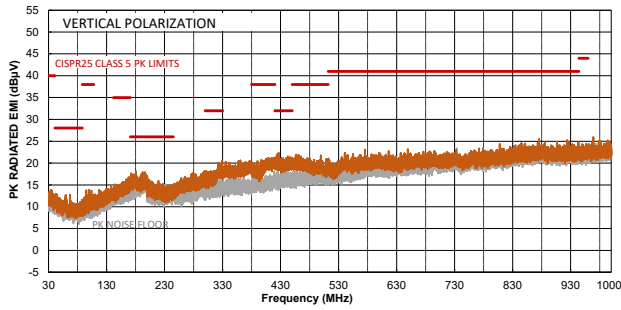

CISPR25 Class 5 Average Radiated Emissions

Vertical, 30MHz to 1GHz

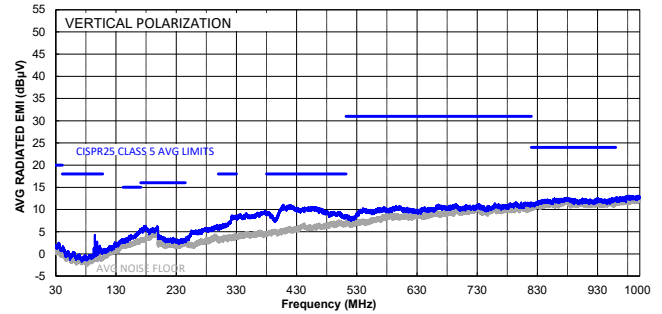

EVB TEST RESULTS (continued)

Performance curves and waveforms are tested on the evaluation board, $V_{IN} = 12V$, $V_{OUT} = 3.3V$, $C_{OUT} = 2 \times 47\mu F$, $L = 4.7\mu H$, $f_{sw} = 410kHz$, $T_A = 25^\circ C$, unless otherwise noted.

Steady State

$I_{OUT} = 0A$, AAM mode

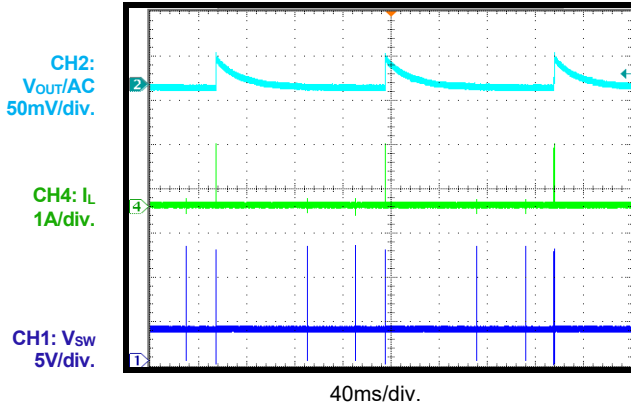

Steady State

$I_{OUT} = 0A$, FCCM

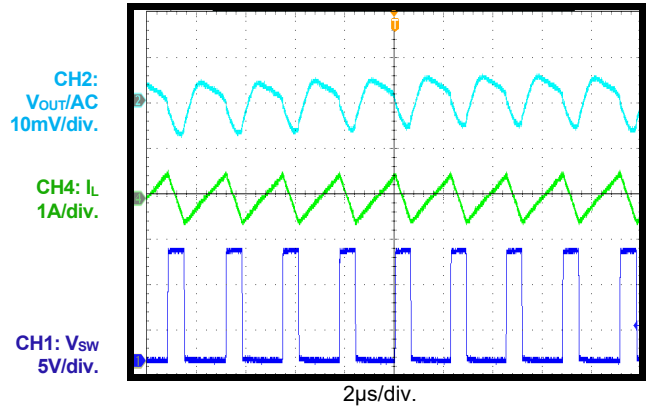

Steady State

$I_{OUT} = 5A$

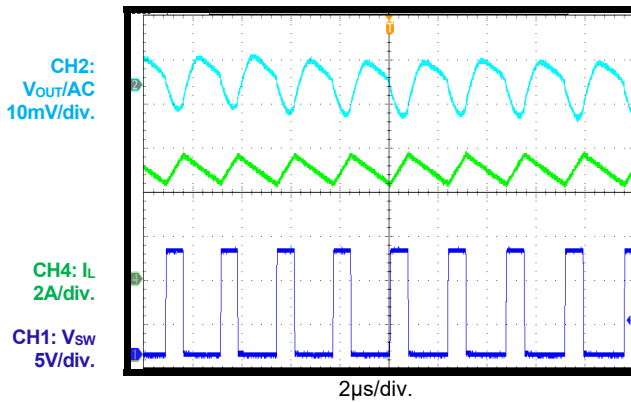

Start-Up through VIN

$I_{OUT} = 0A$, AAM mode

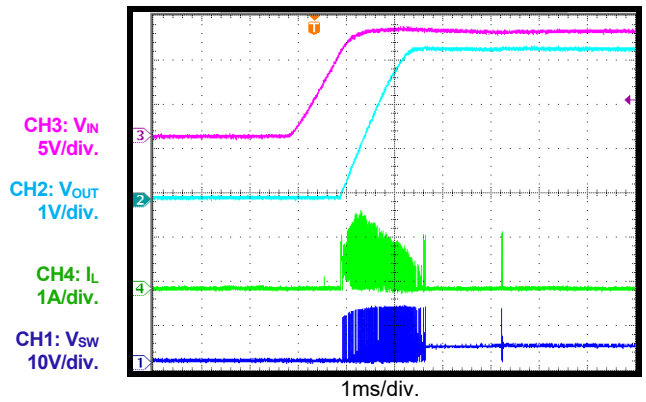

Start-Up through VIN

$I_{OUT} = 0A$, FCCM

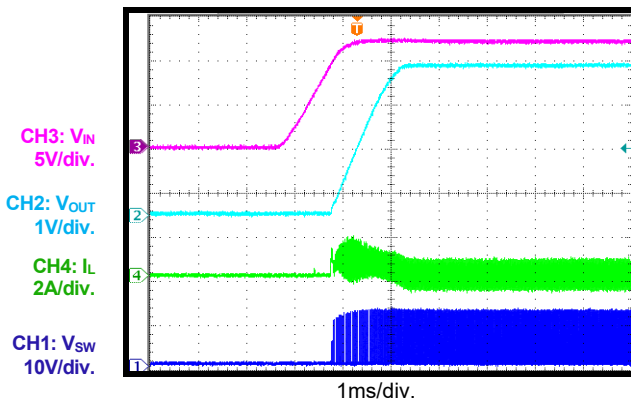

Start-Up through VIN

$I_{OUT} = 5A$

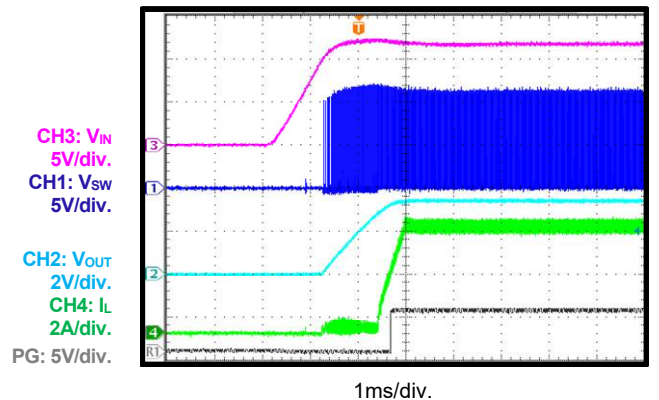

EVb TEST RESULTS (continued)

Performance curves and waveforms are tested on the evaluation board, $V_{IN} = 12V$, $V_{OUT} = 3.3V$, $C_{OUT} = 2 \times 47\mu F$, $L = 4.7\mu H$, $f_{SW} = 410kHz$, $T_A = 25^\circ C$, unless otherwise noted.

Shutdown through VIN

$I_{OUT} = 0A$, AAM mode

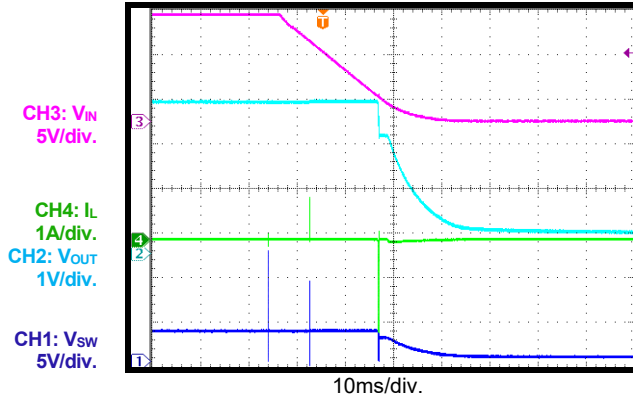

Shutdown through VIN

$I_{OUT} = 0A$, FCCM

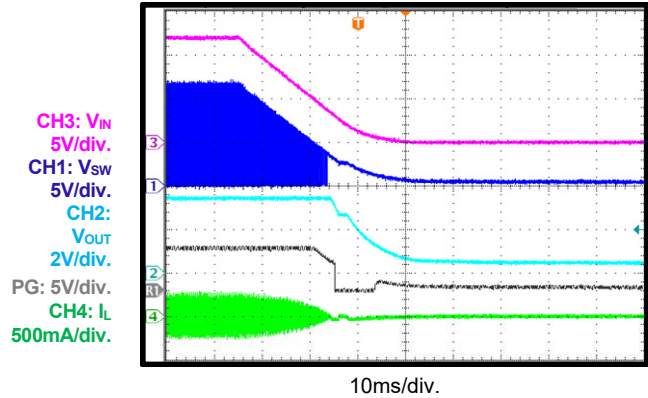

Shutdown through VIN

$I_{OUT} = 5A$

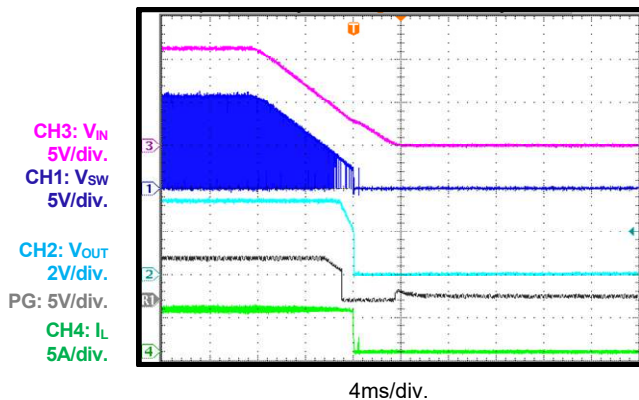

Start-Up through EN

$I_{OUT} = 0A$, AAM mode

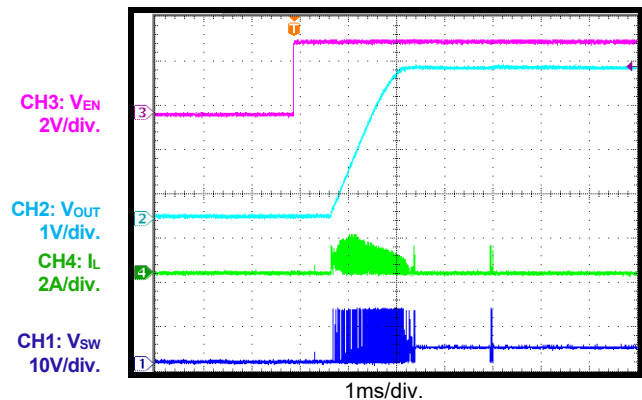

Start-Up through EN

$I_{OUT} = 0A$, FCCM

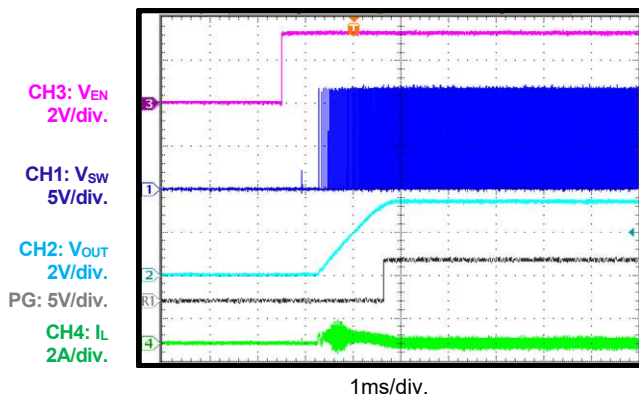

Start-Up through EN

$I_{OUT} = 5A$

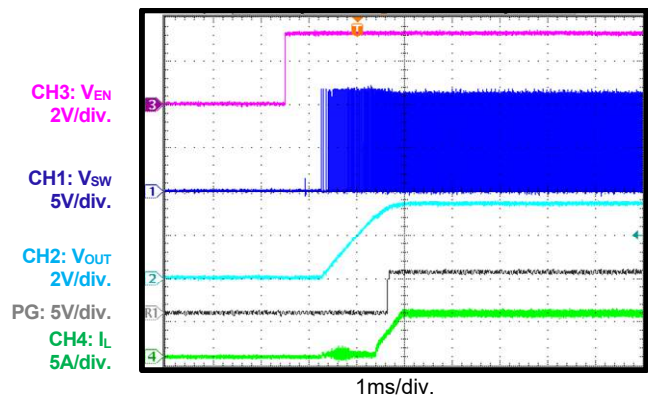

EVB TEST RESULTS (continued)

Performance curves and waveforms are tested on the evaluation board, $V_{IN} = 12V$, $V_{OUT} = 3.3V$, $C_{OUT} = 2 \times 47\mu F$, $L = 4.7\mu H$, $f_{sw} = 410kHz$, $T_A = 25^\circ C$, unless otherwise noted.

Shutdown through EN

$I_{OUT} = 0A$, AAM mode

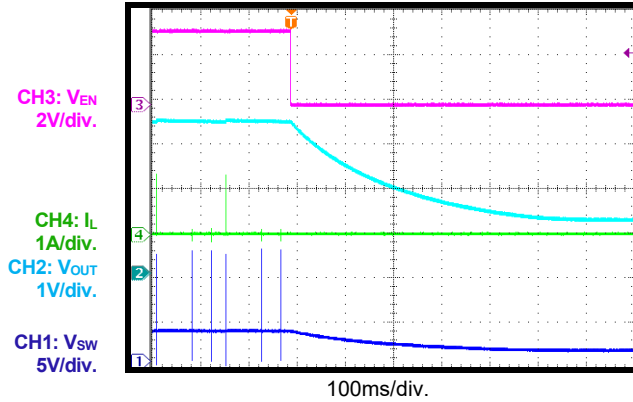

Shutdown through EN

$I_{OUT} = 0A$, FCCM

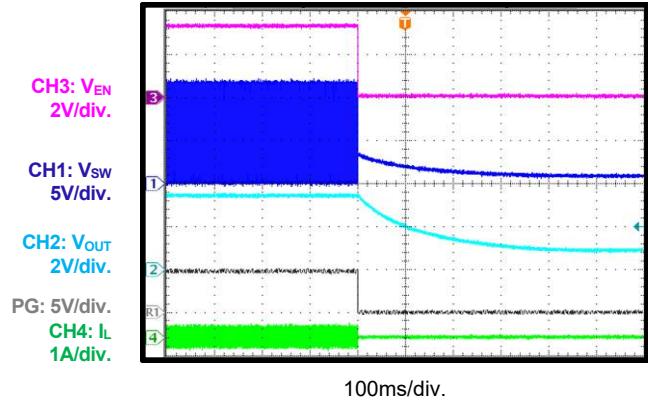

Shutdown through EN

$I_{OUT} = 5A$

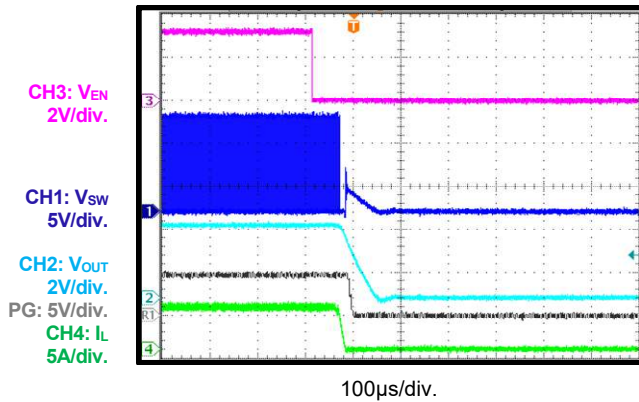

SCP Entry

$I_{OUT} = 0A$, AAM mode

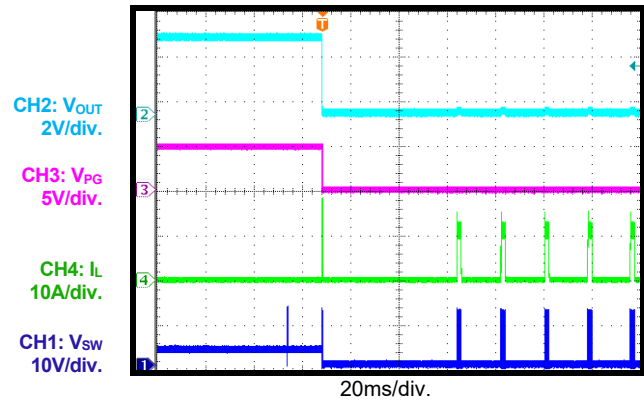

SCP Entry

$I_{OUT} = 0A$, FCCM

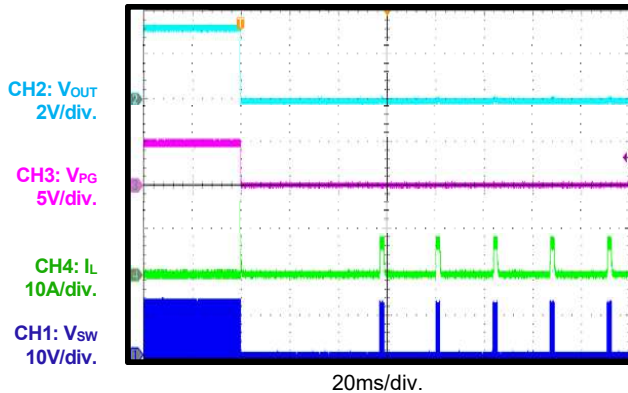

SCP Entry

$I_{OUT} = 5A$

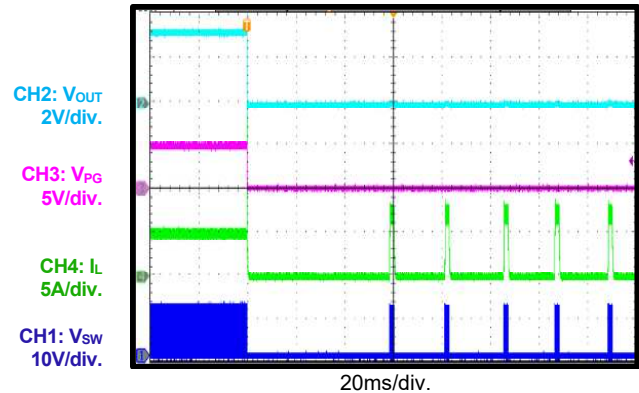

EVB TEST RESULTS (continued)

Performance curves and waveforms are tested on the evaluation board, $V_{IN} = 12V$, $V_{OUT} = 3.3V$, $C_{OUT} = 2 \times 47\mu F$, $L = 4.7\mu H$, $f_{SW} = 410kHz$, $T_A = 25^\circ C$, unless otherwise noted.

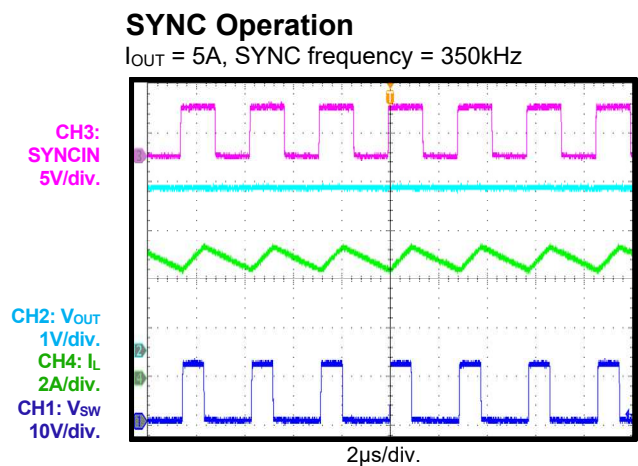
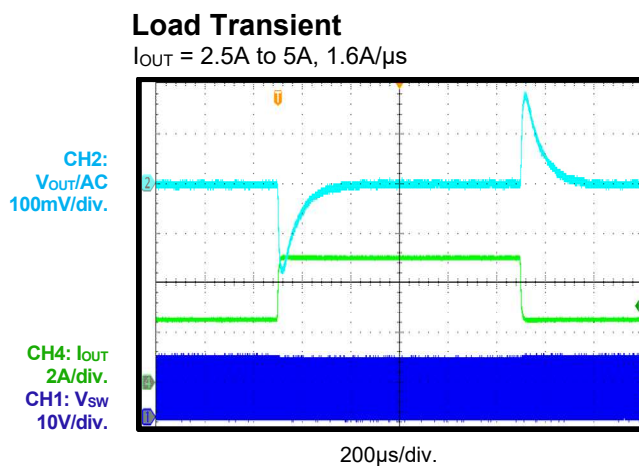
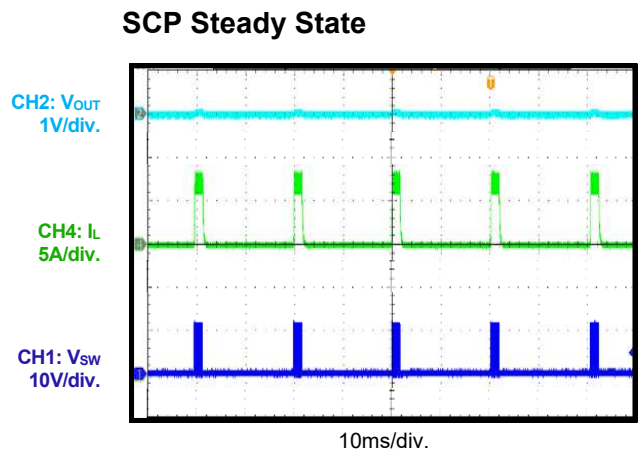
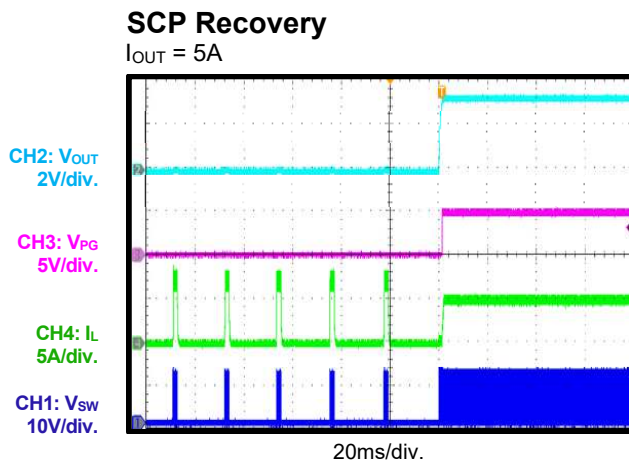
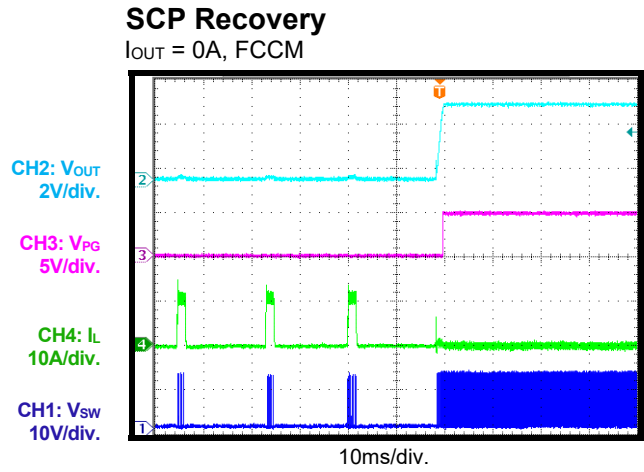
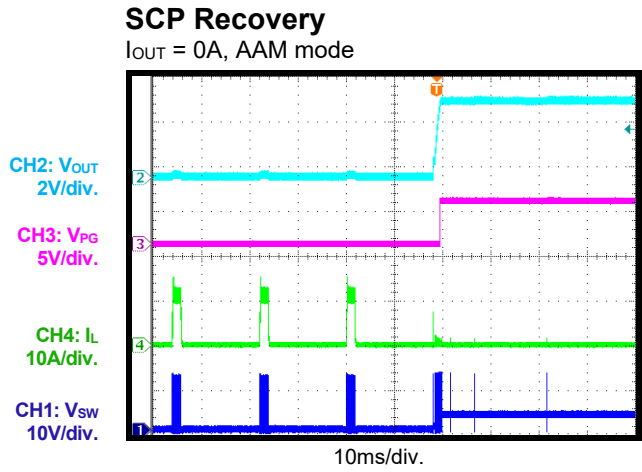

EVB TEST RESULTS (continued)

Performance curves and waveforms are tested on the evaluation board, $V_{IN} = 12V$, $V_{OUT} = 3.3V$, $C_{OUT} = 2 \times 47\mu F$, $L = 4.7\mu H$, $f_{sw} = 410kHz$, $T_A = 25^\circ C$, unless otherwise noted.

PG in Shutdown through EN

$I_{OUT} = 0A$, AAM mode

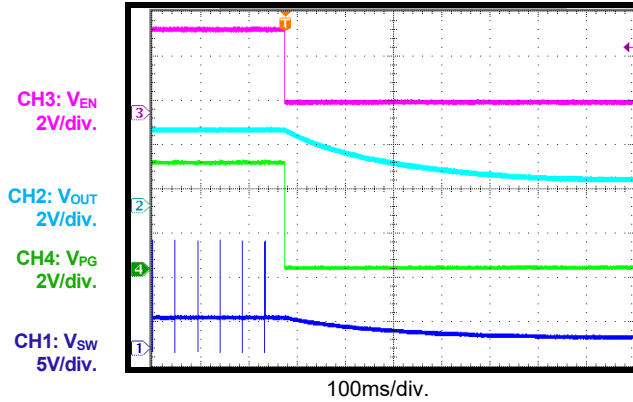

Low-Dropout Mode

$V_{IN} = 3.3V$, V_{OUT} set to 3.3V, $I_{OUT} = 0A$

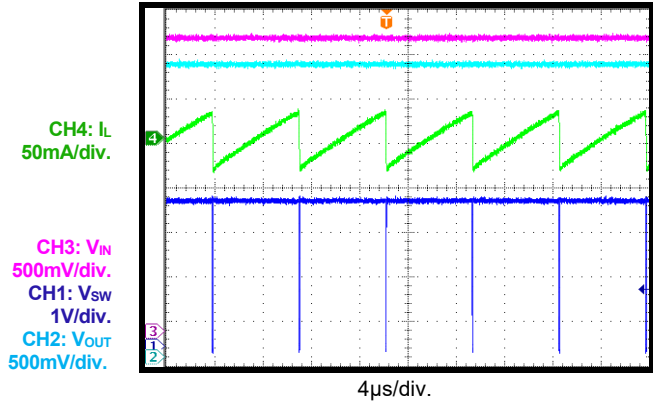

Low-Dropout Mode

$V_{IN} = 3.3V$, V_{OUT} set to 3.3V, $I_{OUT} = 5A$

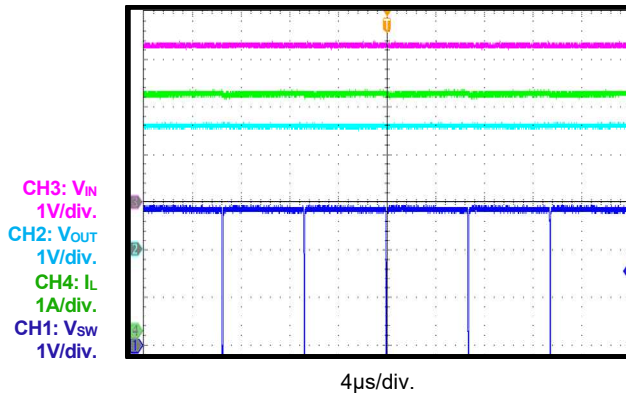

Load Dump

$V_{IN} = 12V$ to 36V, $I_{OUT} = 5A$

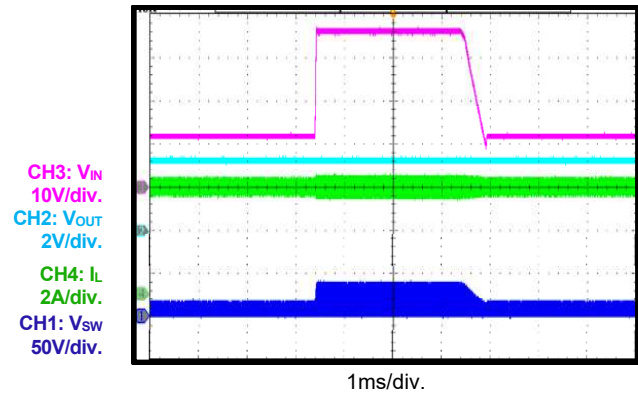

Cold Crank

$V_{IN} = 12V$ to 3.3V to 5V, $I_{OUT} = 5A$

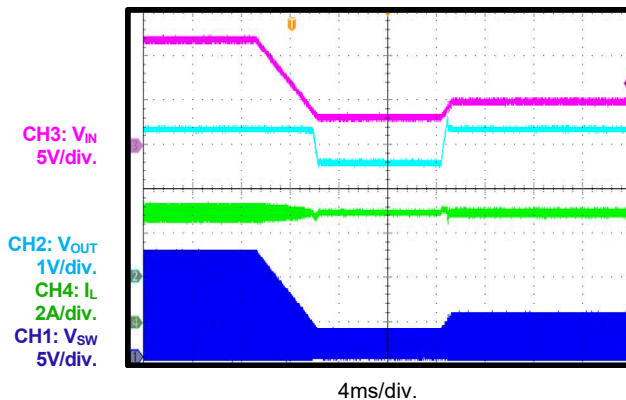

V_{IN} Ramping Up and Down

$I_{OUT} = 0.1A$

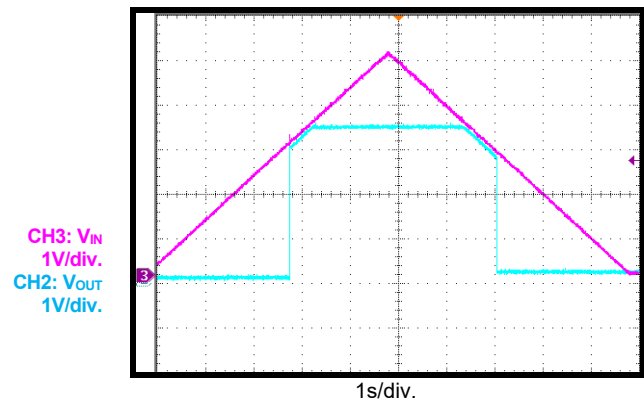

EVB TEST RESULTS *(continued)*

Performance curves and waveforms are tested on the evaluation board, $V_{IN} = 12V$, $V_{OUT} = 3.3V$, $C_{OUT} = 2 \times 47\mu F$, $L = 4.7\mu H$, $f_{sw} = 410kHz$, $T_A = 25^\circ C$, unless otherwise noted.

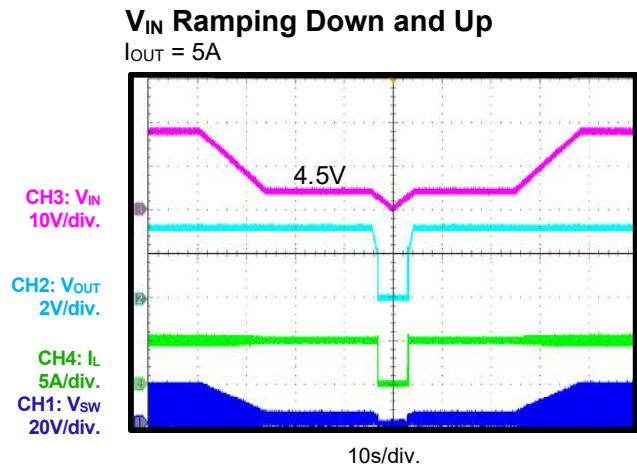
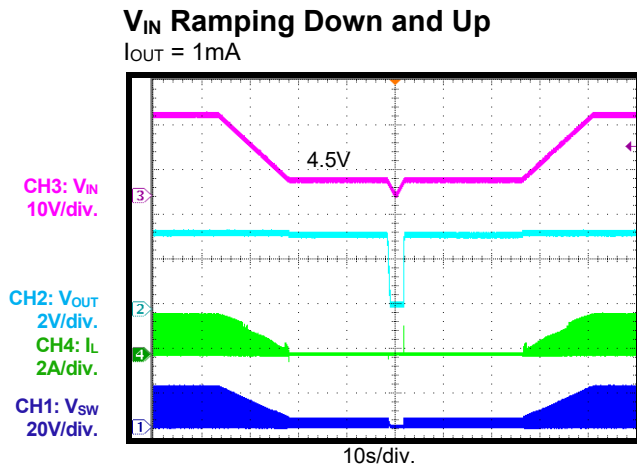

PCB LAYOUT (2)

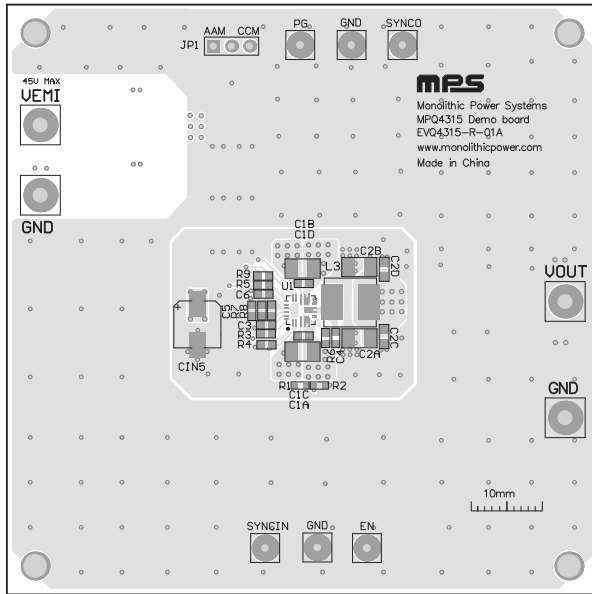

Figure 4: Top Silk and Top Layer

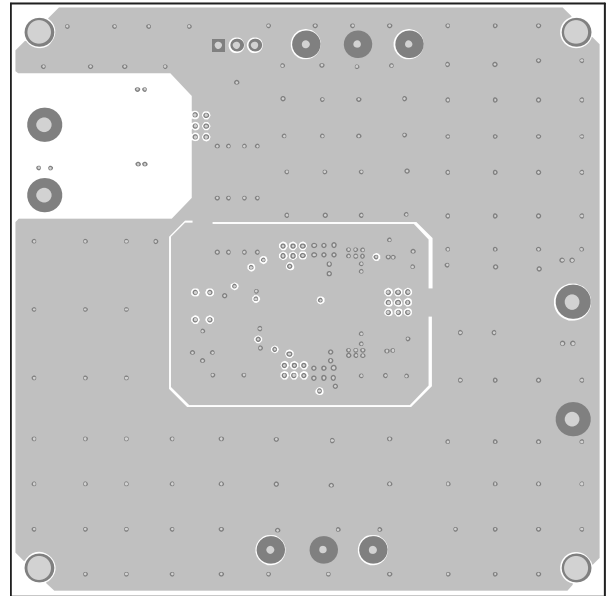

Figure 5: Mid-Layer 1

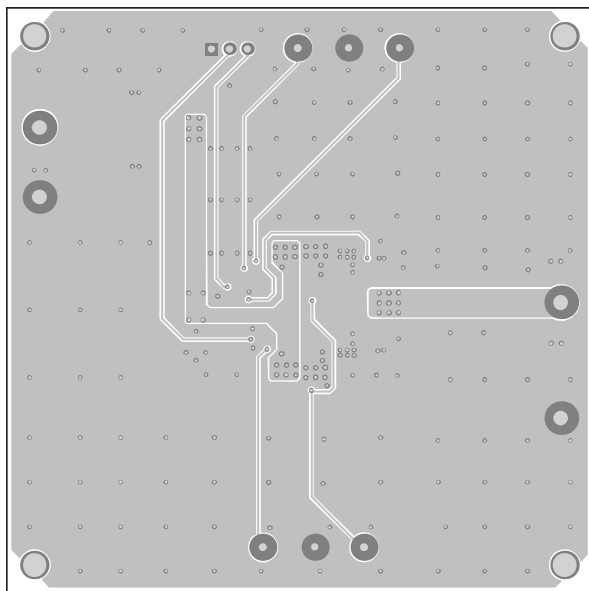

Figure 6: Mid-Layer 2

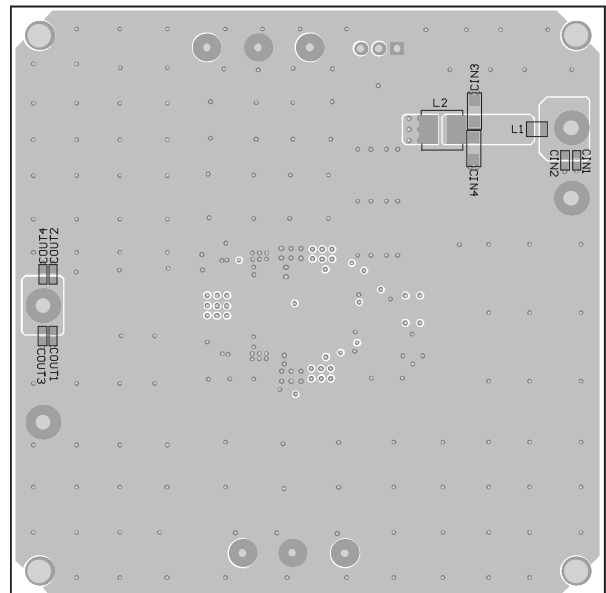

Figure 7: Bottom Layer and Bottom Silk

Note:

2) The copper thickness is 2oz.

REVISION HISTORY

Revision #	Revision Date	Description	Pages Updated
1.0	3/21/2022	Initial Release	-

Notice: The information in this document is subject to change without notice. Please contact MPS for current specifications. Users should warrant and guarantee that third-party Intellectual Property rights are not infringed upon when integrating MPS products into any application. MPS will not assume any legal responsibility for any said applications.