



One-Time Digitally Programmable 32-Tap Potentiometer

FEATURES

- Wiper position stored after one-time non-volatile programming
- User-defined Power-On wiper position
- 32-tap positions
- Wiper position programmed through simple 2-wire serial interface
- Low 0.35µA (typ) static supply current
- 2.5V to 5.5V single-supply operation
- 10kΩ, 50kΩ, and 100kΩ end-to-end resistances
- 50ppm/°C end-to-end temperature coefficient and 5ppm/°C ratiometric temperature coefficient
- TDFN 8-pad (2 x 3mm) and MSOP 8-lead packages

APPLICATIONS

- Mechanical potentiometer replacement
- Products using one-time factory calibration
- Contrast, brightness, volume controls
- Programmable analog functions

DESCRIPTION

The CAT5126 is a digital programmable potentiometer. The wiper position is controlled with a simple 2-wire digital interface. This digital potentiometer is unique in that it has an optional one-time programmable feature that either sets the wiper's position upon power-on to a user-defined value, or the wiper can be set and the interface also disabled to prevent further adjustment.

The CAT5126 has an end-to-end resistance of 10kΩ, 50kΩ, and 100kΩ. All CAT5126 devices have 32-wiper positions and operate from a single 2.5V to 5.5V supply.

The CAT5126 is available in TDFN 8-pad and MSOP 8-lead packages. Each device is guaranteed over the industrial temperature range of -40°C to +85°C.

For Ordering Information details, see page 10.

PIN CONFIGURATION

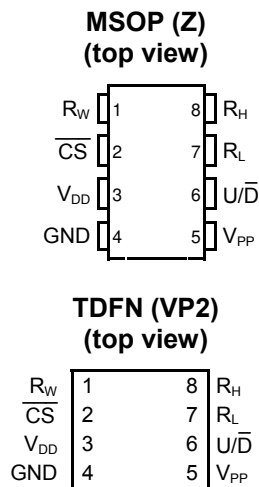

FUNCTIONAL DIAGRAM

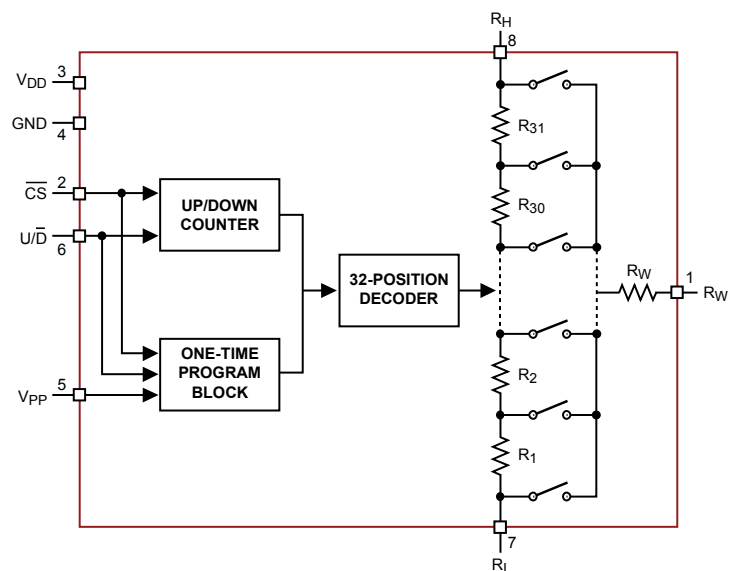

PIN DESCRIPTION

| Pin | Name | Function |
|-----|-------------------|--|
| 1 | R _W | Wiper Connection |
| 2 | \overline{CS} | Chip-Select Input. A high-to-low \overline{CS} transition determines the mode: increment if U/ \overline{D} is high, or decrement if U/ \overline{D} is low. \overline{CS} is also used for one-time programming (see the One-Time Programming section). |
| 3 | V _{DD} | Power-Supply Voltage |
| 4 | GND | Ground |
| 5 | V _{PP} | Programming Voltage for One-Time Programming. Connect V _{PP} to 10V supply when one-time programming the device. For normal operation, connect to ground or let float. |
| 6 | U/ \overline{D} | Up/Down Control Input. With \overline{CS} low, a low-to-high transition increments or decrements the wiper position. |
| 7 | R _L | Low Terminal of Resistor |
| 8 | R _H | High Terminal of Resistor |

ABSOLUTE MAXIMUM RATINGS ⁽¹⁾

| Parameters | Ratings | Units |
|---|------------------------------|----------|
| V _{DD} to GND | -0.5 to +7.0 | V |
| V _{PP} to GND | -0.5 to +12.0 | V |
| All other pins to GND | -0.5 to V _{DD} +0.5 | V |
| Maximum Continuous Current into H, L, and W | ±1.5 | mA |
| Continuous Power Dissipation (T _A = +70°C) MSOP 8-Lead (derate 4.5mW/°C above +70°C) TDFN 8-Pad (derate 24.4mW/°C above +70°C) | 362 1951 | mW mW |
| Operating Temperature Range | -40 to +85 | °C |
| Junction Temperature | +150 | °C |
| Storage Temperature Range | -65 to +150 | °C |
| Lead Temperature (soldering, 10s) | +300 | °C |

Notes:

- (1) Stresses above those listed under “Absolute Maximum Ratings” may cause permanent damage to the device. These are stress ratings only, and functional operation of the device at these or any other conditions outside of those listed in the operational sections of this specification is not implied. Exposure to any absolute maximum rating for extended periods may affect device performance and reliability.

ELECTRICAL CHARACTERISTICS

$V_{DD} = 2.5V$ to $5.5V$, $V_{PP} = GND$, $R_H = V_{DD}$, $R_L = GND$, $T_A = -40^{\circ}C$ to $+85^{\circ}C$, unless otherwise noted. Typical values are at $V_{DD} = 5.0V$, $T_A = +25^{\circ}C$, unless otherwise noted.⁽¹⁾

| Symbol | Parameter | Conditions | Min | Typ | Max | Units |
|---|-------------------------------|--------------------------------------|---------------------|------|---------------------|--------|
| DC PERFORMANCE | | | | | | |
| RES | Resolution | | | 3.2 | | % |
| R _{POT} | End-to-End Resistance | -10 Device | 8 | 10 | 12 | kΩ |
| | | -50 Device | 40 | 50 | 60 | |
| | | -00 Device | 80 | 100 | 120 | |
| TC _{R_{POT}} | TC of Pot Resistance | | | ±50 | ±300 | ppm/°C |
| TC _{R_{RATIO}} | Ratiometric Resistance TC | | | ±5 | ±20 | ppm/°C |
| INL | Integral Nonlinearity | Potentiometer configuration, no load | | 0.5 | 1 | LSB |
| DNL | Differential Nonlinearity | Potentiometer configuration, no load | | 0.25 | 0.5 | LSB |
| R _W | Wiper Resistance | $V_{DD} = 5V$ | | 70 | 100 | Ω |
| | | $V_{DD} = 2.5V$ | | 150 | 200 | Ω |
| DIGITAL INPUTS (\overline{CS}, U/\overline{D}) | | | | | | |
| V _{IH} | Input High Voltage | | $0.7 \times V_{DD}$ | | | V |
| V _{IL} | Input Low Voltage | | | | $0.3 \times V_{DD}$ | V |
| I _{IN} | Input Leakage Current | | | ±0.1 | ±1 | μA |
| C _{IN} | Input Capacitance | | | 5 | | pF |
| POWER SUPPLY | | | | | | |
| V _{DD} | Supply Voltage | | 2.5 | | 5.5 | V |
| I _{DD} | Stand by Current | (Note 2) | | 0.35 | 1 | μA |
| I _{DDW} | Programming Current | | | 0.25 | 1 | mA |
| V _{PP} | Programming Voltage | $V_{DD} = 5V$ | | 8.5 | 10 | V |
| | | $V_{DD} = 2.5V$ | | 6.0 | 10 | |
| I _{PP} | V _{PP} Input Current | $V_{PP} = 10V$ | | | 5 | μA |

Notes:

- (1) All devices are production tested at $T_A = +25^{\circ}C$ and are guaranteed by design for $T_A = -40^{\circ}C$ to $+85^{\circ}C$.
- (2) Digital inputs \overline{CS} and U/\overline{D} are connected to GND or V_{DD} .

ELECTRICAL CHARACTERISTICS (continued)

$V_{DD} = 2.5V$ to $5.5V$, $V_{PP} = GND$, $V_H = V_{DD}$, $V_L = GND$, $T_A = -40^{\circ}C$ to $+85^{\circ}C$, unless otherwise noted. Typical values are at $V_{DD} = 5.0V$, $T_A = +25^{\circ}C$, unless otherwise noted. ⁽¹⁾

| TIMING CHARACTERISTICS ⁽²⁾ | | | | | | |
|---------------------------------------|---|---|-----|------|-----|---------|
| Symbol | Parameter | Conditions | Min | Typ | Max | Units |
| t_{CU} | U/D Mode to \overline{CS} Setup | Figures 1, 2 | 50 | | | ns |
| t_{CI} | \overline{CS} Hold to U/D Mode | Figures 1, 2 | 50 | | | ns |
| t_{C} | U/D Step Hold to \overline{CS} | Figures 1, 2 | 0 | | | ns |
| t_{IL} | U/D Step Low Time | Figures 1, 2 | 100 | | | ns |
| t_{IH} | U/D Step High Time | Figures 1, 2 | 100 | | | ns |
| t_{W} | Wiper Switching Time | $C_L = 0pF$, Figures 1, 2 | | 100 | | ns |
| t_{PC} | V_{PP} Rising Edge to \overline{CS} Falling Edge | Figure 3 | 1 | | | ms |
| t_{CP} | \overline{CS} Falling Edge to V_{PP} Falling Edge | Figure 3 | 5 | | | ms |
| t_{CL} | \overline{CS} Step Low Time | Figure 3 | 5 | | | ms |
| t_{CH} | \overline{CS} Step High Time | Figure 3 | 5 | | | ms |
| t_{PH} | V_{PP} Falling Edge to \overline{CS} Rising Edge | Figure 3 | 1 | | | ms |
| $f_{U/DMAX}$ | U/D Frequency | | | | 5 | MHz |
| t_{UP} | Power-Up Time | (Note 3) | | | 1 | ms |
| t_{SETTLE} | Output Settling Time | 100k Ω variable resistor configuration, $C_L = 10pF$ | | 1 | | μs |
| | | 100k Ω potentiometer configuration, $C_L = 10pF$ | | 0.25 | | |

Notes:

- (1) All devices are production tested at $T_A = +25^{\circ}C$ and are guaranteed by design for $T_A = -40^{\circ}C$ to $+85^{\circ}C$.
- (2) Digital timing is guaranteed by design, not production tested.
- (3) Power-up time is the period of time from when the power supply is applied until the serial interface is ready for writing.

TYPICAL OPERATING CHARACTERISTICS

$V_{DD} = 2.5V$ to $5.5V$, $V_{PP} = GND$, $V_H = V_{DD}$, $V_L = GND$, $T_A = +25^\circ C$.

V_{PP} vs. V_{DD}

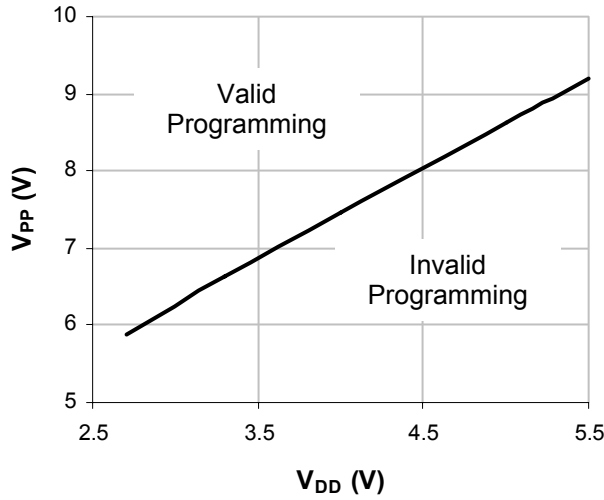

I_{DD} programming vs. V_{DD}

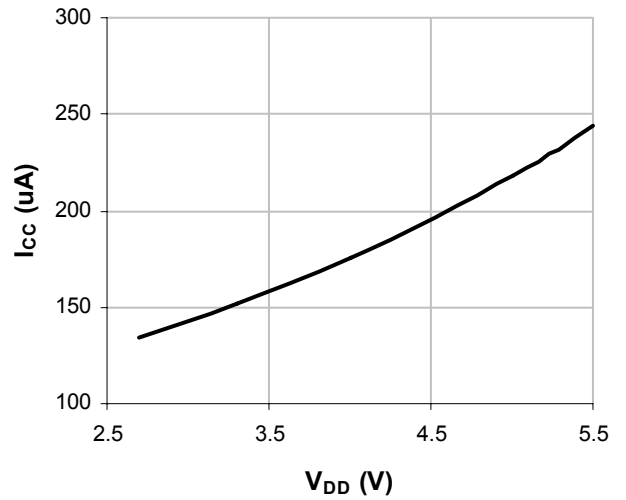

Wiper Resistance vs. Tap Position @ 25°C

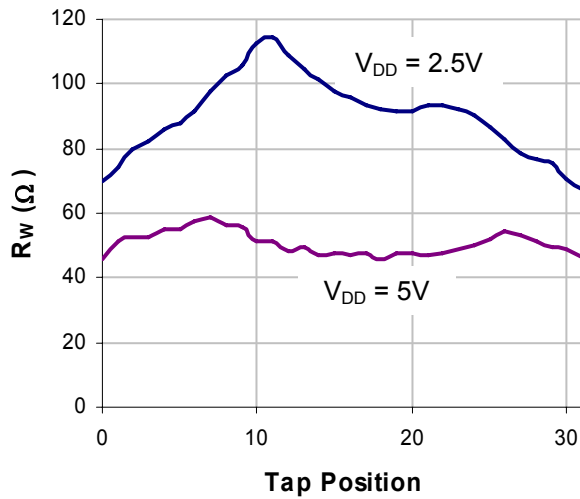

Wiper Voltage vs. Tap Position

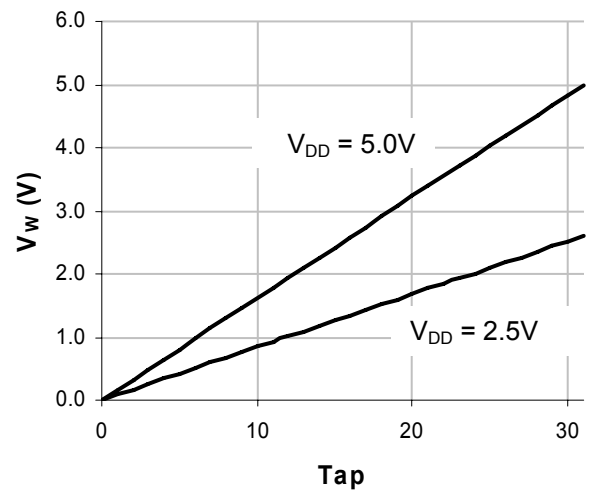

DETAILED DESCRIPTION

The CAT5126 devices are 10kΩ/50kΩ/100kΩ (end-to-end resistance) digitally controlled potentiometers. They have 32-tap positions that are accessible to the wiper along the resistor array between R_H and R_L .

The wiper (R_W) position is adjusted sequentially through the tap positions using a simple I²C interface. These digital potentiometers have an optional one-time programmable feature that sets the POR position of the wiper. The I²C interface can then be disabled, permanently preventing unwanted adjustment.

DIGITAL INTERFACE OPERATION

The CAT5126 devices have two modes of operation when the serial interface is active: increment mode and decrement mode. The serial interface is only active when \overline{CS} is low.

The \overline{CS} and U/\overline{D} inputs control the position of the wiper along the resistor array. When \overline{CS} transitions from high to low, the part goes into increment mode if U/\overline{D} is high (Figure 1), and into decrement mode if U/\overline{D} is low (Figure 2). Once the mode is set, the device remains in that mode until \overline{CS} goes high. A low-to-high transition at the U/\overline{D} increments or

decrements the wiper position depending on the current mode.

The value of the counter is then stored and the wiper position is maintained till the device is Powered down.

The wiper performs a make-before-break transition, ensuring that there is never an open circuit during a transition from one resistor tap to another. When the wiper is at either end (max/min) of the resistor array, additional transitions in the direction of the endpoint do not change the counter value (the counter does not wrap around).

One-Time Programming

The factory-set default position of the wiper on power-up is tap 16. However, the power-up position can be changed once using the one-time programming feature. After the wiper is moved to the desired position, the programming sequence is initiated by setting U/\overline{D} high, applying 10V to V_{PP} , and then taking \overline{CS} low. Five pulses on \overline{CS} (consisting of \overline{CS} starting from low and going high for t_{CH} and then low for t_{CL}) program the device (Figure 3). The programming voltage should then be taken to zero. After the device is programmed, V_{PP} can be set to zero or be allowed to float. The wiper position is still adjustable, but always returns to this programmed position on power-up.

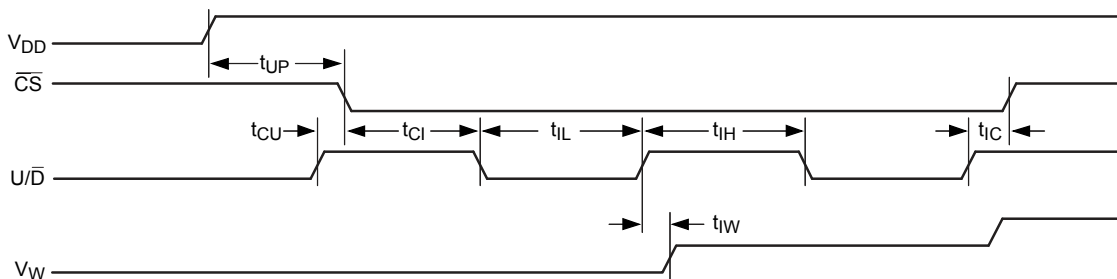

Figure 1. Increment Mode Serial Interface Timing Diagram

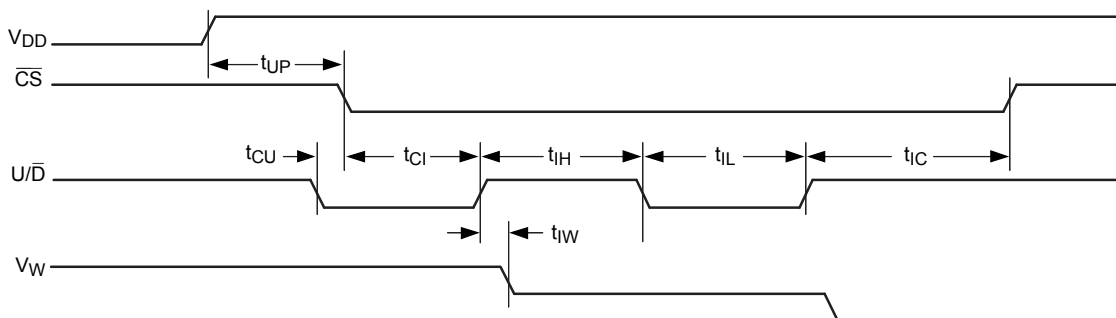

Figure 2. Decrement Mode Serial Interface Timing Diagram

If the intent is to program the device to a specific wiper position and not to allow further adjustments, then six programming pulses are required (as opposed to five), as shown in Figure 3. The sixth pulse locks the wiper position and disables the serial interface. This also allows $\overline{U/D}$ and \overline{CS} to float without any increase in supply current. Once the lockout bit is set, no further adjustment to the potentiometer is possible, effectively changing the potentiometer into a fixed resistor-divider (Table 1).

pulses (program the initial power-up value of the device, but still be able to adjust the wiper). If the device is programmed with five pulses and later it is desired to disable the interface (convert to a fixed voltage-divider), then care must be taken to ensure that the wiper is in the same position as it was originally set to (when programmed with five pulses). The full six programming pulses must be applied. Note that once the six-pulse program occurs, no further programming is possible.

It is recommended that the user either use six \overline{CS} pulses (convert to a fixed voltage-divider) or five

Table 1. One-Time Programming Mode

| Mode | Power Up Position | Interface | Operation |
|---|-------------------------------------|---|--|
| Factory Default | At midscale | Active | Programming allowed |
| Programming with 5 pulses at the midscale position | At midscale | Active | Programming allowed |
| Programming with 5 pulses different from midscale position – only once | At the new programmed position | Active | No further change in power-up position allowed |
| Programming with 5 pulses if the power up position was changed before | At the previous programmed position | Active | None |
| Programming with 6 pulses if the tap position is at midscale | Midscale position forever | I ² C interface active till power down | I ² C interface disable after next power-up |
| Programming ONLY with 6 pulses if the tap position is different from midscale position | At the new programmed position | I ² C interface active till power down | I ² C interface disable after next power-up |

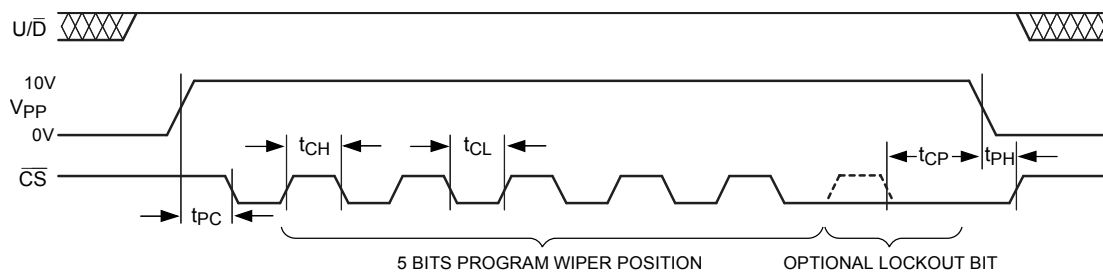

Figure 3. One Time Program Mode Serial Interface Timing Diagram

Notes:

- (1) If CAT5126 is Programmed with less than 5 pulses, it does not change the Power-up recall position.
- (2) During internal power-up the wiper is forced to midscale; thereafter the wiper is set at the stored position.

CAT5126

PACKAGE OUTLINE DRAWINGS

MSOP 8-Lead 3 x 3mm (Z) ⁽¹⁾⁽²⁾

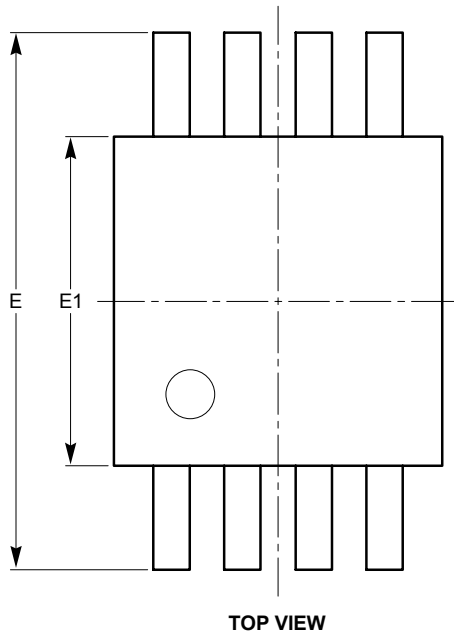

| SYMBOL | MIN | NOM | MAX |
|----------|----------|------|------|
| A | | | 1.10 |
| A1 | 0.05 | 0.10 | 0.15 |
| A2 | 0.75 | 0.85 | 0.95 |
| b | 0.22 | | 0.38 |
| c | 0.13 | | 0.23 |
| D | 2.90 | 3.00 | 3.10 |
| E | 4.80 | 4.90 | 5.00 |
| E1 | 2.90 | 3.00 | 3.10 |
| e | 0.65 BSC | | |
| L | 0.40 | 0.60 | 0.80 |
| L1 | 0.95 REF | | |
| L2 | 0.25 BSC | | |
| θ | 0° | | 6° |

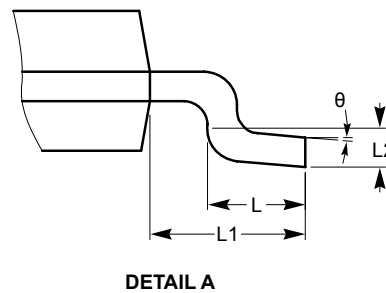
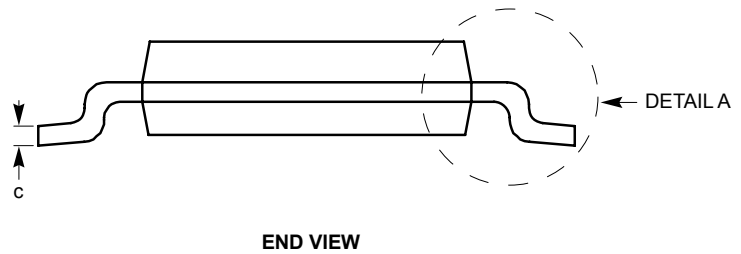
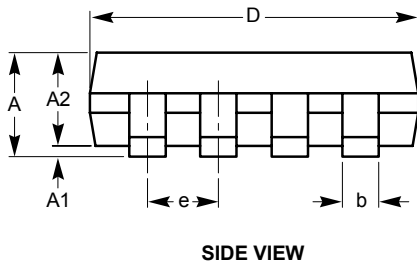

For current Tape and Reel information, download the PDF file from:
<http://www.catsemi.com/documents/tapeandreeel.pdf>.

Notes:

- (1) All dimensions are in millimeters. Angles in degrees.
- (2) Complies with JEDEC Specification MO-187.

TDFN 8-Pad 2mm x 3mm (VP2) ⁽¹⁾⁽²⁾

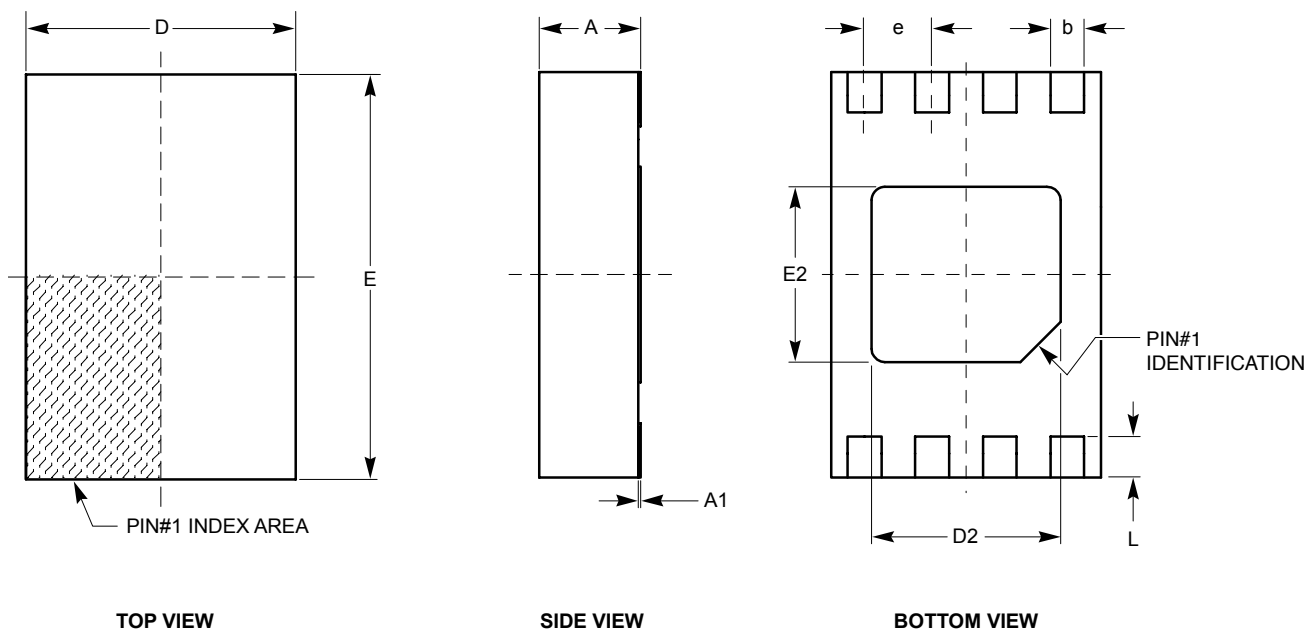

| SYMBOL | MIN | NOM | MAX |
|--------|----------|------|------|
| A | 0.70 | 0.75 | 0.80 |
| A1 | 0.00 | 0.02 | 0.05 |
| A2 | 0.45 | 0.55 | 0.65 |
| A3 | 0.20 REF | | |
| b | 0.20 | 0.25 | 0.30 |
| D | 1.90 | 2.00 | 2.10 |
| D2 | 1.30 | 1.40 | 1.50 |
| E | 2.90 | 3.00 | 3.10 |
| E2 | 1.20 | 1.30 | 1.40 |
| e | 050 TYP | | |
| L | 0.20 | 0.30 | 0.40 |

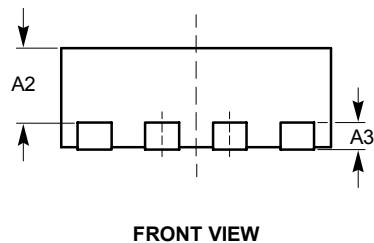

For current Tape and Reel information, download the PDF file from:
<http://www.catsemi.com/documents/tapeandreeel.pdf>

Notes:

- (1) All dimensions are in millimeters. Angles in degrees.
- (2) Complies with JEDEC Specification MO-229.

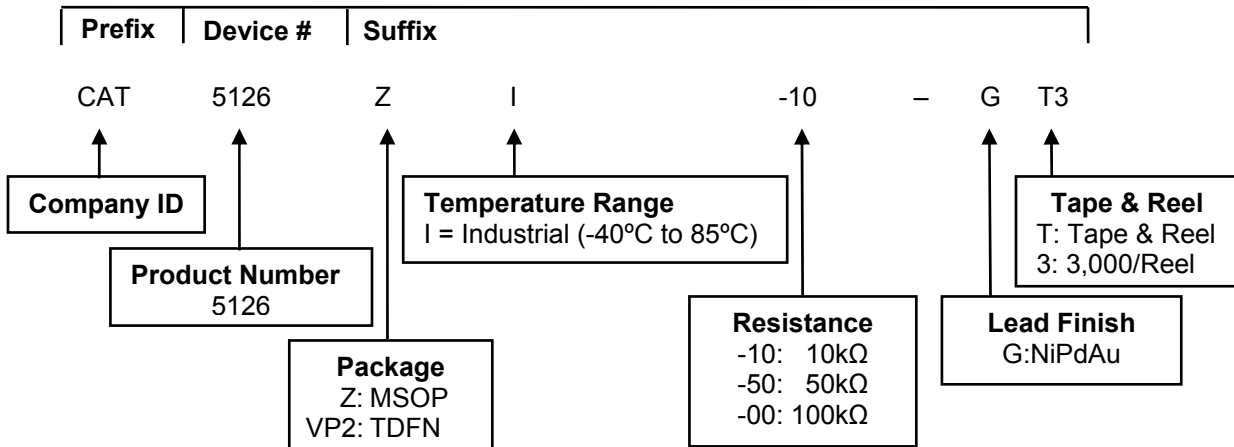
EXAMPLE OF ORDERING INFORMATION

ORDERING INFORMATION

| Ordering Part Number | Resistor [kΩ] | Package-Pin | Part Per Reel |
|-----------------------------------|---------------|-------------|---------------|
| CAT5126VP2I-10-GT3 | 10 | TDFN | 3000 |
| CAT5126VP2I-50-GT3 ⁽⁴⁾ | 50 | TDFN | 3000 |
| CAT5126VP2I-00-GT3 ⁽⁴⁾ | 100 | TDFN | 3000 |
| CAT5126ZI-10-GT3 | 10 | MSOP | 3000 |
| CAT5126ZI-50-GT3 ⁽⁴⁾ | 50 | MSOP | 3000 |
| CAT5126ZI-00-GT3 ⁽⁴⁾ | 100 | MSOP | 3000 |

For Product Top Mark Codes, click here:
<http://www.catsemi.com/techsupport/producttopmark.asp>

Notes:

- (1) All packages are RoHS-compliant (Lead-free, Halogen-free).
- (2) The standard lead finish is NiPdAu.
- (3) The device used in the above example is a CAT5126ZI-10-GT3 (MSOP, Industrial Temperature range, 10kΩ, NiPdAu, Tape & Reel, 3,000/Reel).
- (4) For additional package and temperature options, please contact your nearest Catalyst Semiconductor Sales office.

REVISION HISTORY

| Date | Rev. | Reason |
|----------|------|--|
| 03/14/07 | A | Initial Issue |
| 03/12/08 | B | Add Top Mark Code link Add -MD to document number |

Copyrights, Trademarks and Patents

© Catalyst Semiconductor, Inc.

Trademarks and registered trademarks of Catalyst Semiconductor include each of the following:

Adaptive Analog™, Beyond Memory™, DPP™, EZDim™, LDD™, MiniPot™, Quad-Mode™ and Quantum Charge Programmable™

Catalyst Semiconductor has been issued U.S. and foreign patents and has patent applications pending that protect its products.

CATALYST SEMICONDUCTOR MAKES NO WARRANTY, REPRESENTATION OR GUARANTEE, EXPRESS OR IMPLIED, REGARDING THE SUITABILITY OF ITS PRODUCTS FOR ANY PARTICULAR PURPOSE, NOR THAT THE USE OF ITS PRODUCTS WILL NOT INFRINGE ITS INTELLECTUAL PROPERTY RIGHTS OR THE RIGHTS OF THIRD PARTIES WITH RESPECT TO ANY PARTICULAR USE OR APPLICATION AND SPECIFICALLY DISCLAIMS ANY AND ALL LIABILITY ARISING OUT OF ANY SUCH USE OR APPLICATION, INCLUDING BUT NOT LIMITED TO, CONSEQUENTIAL OR INCIDENTAL DAMAGES.

Catalyst Semiconductor products are not designed, intended, or authorized for use as components in systems intended for surgical implant into the body, or other applications intended to support or sustain life, or for any other application in which the failure of the Catalyst Semiconductor product could create a situation where personal injury or death may occur.

Catalyst Semiconductor reserves the right to make changes to or discontinue any product or service described herein without notice. Products with data sheets labeled "Advance Information" or "Preliminary" and other products described herein may not be in production or offered for sale.

Catalyst Semiconductor advises customers to obtain the current version of the relevant product information before placing orders. Circuit diagrams illustrate typical semiconductor applications and may not be complete.



Catalyst Semiconductor, Inc.
Corporate Headquarters
2975 Stender Way
Santa Clara, CA 95054
Phone: 408.542.1000
Fax: 408.542.1200
1Hwww.catsemi.com

Document No: MD-2129
Revision: B
Issue date: 03/12/08