



Bridgelux® Vero® SE 10 Array

Product Data Sheet DS120



Introduction

Vero SE



Vero® SE Series is a revolutionary light source system that integrates Bridgelux's seventh generation COB technology with poke-in connectivity enabling solder-free installation. Vero SE LED light sources streamline assembly processes, lower manufacturing cost, simplify luminaire design, improve light quality and increase design flexibility.

Vero SE is available in four different light emitting surface (LES) configurations that operate reliably over a broad current range. With Vero SE, secondary connector and holder components are not required, allowing for rapid integration of arrays into fixtures and an efficient field replaceable solution. Vero SE arrays deliver increased lumen density for improved beam control and precision lighting with 2 and 3 SDCM color control standards for clean and consistent uniform lighting.

Bridgelux Décor Series is our state of the art color line designed specifically for premium applications, producing unmatched LED light quality with brilliant color-rendering options and offer pleasing and inspiring lighting palettes. Bridgelux Décor Series color points are available on Vero® SE Series, Vero® Series, V Series™ and V Series™ HD.

Décor Series™ Class A is based on human response testing, providing color points with a combined GAI and CRI metric.

Décor Series™ Ultra products provide a high CRI of 97 and a minimum Rg value of 93, which emphasizes the reds and color tones to which the human eye is most receptive - perfect for the most luxurious retail shops and world renowned museums. Décor Series Ultra is also a good replacement for halogen lamps.

Décor Series™ Street and Landmark is designed to be a direct replacement for high pressure sodium lamps.

Décor Series™ Showcase is the optimal solution for replacing ceramic metal halide lamps, incorporating the same pure white light with enhanced spectrum coverage and higher efficacy.

Features

- Poke-in connectivity
- Efficacy of 150 lm/W typical
- Broad range of CCT options from 2700K to 6500K
- CRI options: minimum 65, 70, 80, and 90
- Color control: 2 and 3 SDCM for 2700K-4000K CCT
- Reliable operation at up to 2X nominal drive current
- Radial die pattern and improved lumen density
- Top side part number markings
- No exposed solder pads or electrical connections
- V_f bin code backside marking

Benefits

- Poke-in connectivity enables solderless, connector free installation
- Broad application coverage for interior and exterior lighting
- Flexibility for application driven lighting design requirements
- High quality, true color reproduction
- Uniform consistent white light
- Flexibility in design optimization
- Enhanced ease of use and assembly
- Ability to configure multiple Vero SE arrays in series and parallel reduces customer driver cost
- Improved inventory management and quality control

Contents

Product Feature Map	2
Product Nomenclature	2
Product Selection Guide	3
Performance at Commonly Used Drive Currents	10
Electrical Characteristics	19
Eye Safety	20
Absolute Maximum Ratings	21
Performance Curves	22
Typical Radiation Pattern	25
Typical Color Spectrum	26
Mechanical Dimensions	27
Color Binning Information	28
Packaging and Labeling	29
Design Resources	31
Precautions	31
Disclaimers	31
About Bridgelux	32

Product Feature Map

Vero SE 10 is the smallest form factor in the product family of next generation solid state light sources. In addition to delivering the performance and light quality required for many lighting applications.

Vero SE incorporates several features to simplify the design integration and manufacturing process, accelerate time to market and reduce system costs. Please visit www.bridgelux.com for more information on the Vero SE family of products.

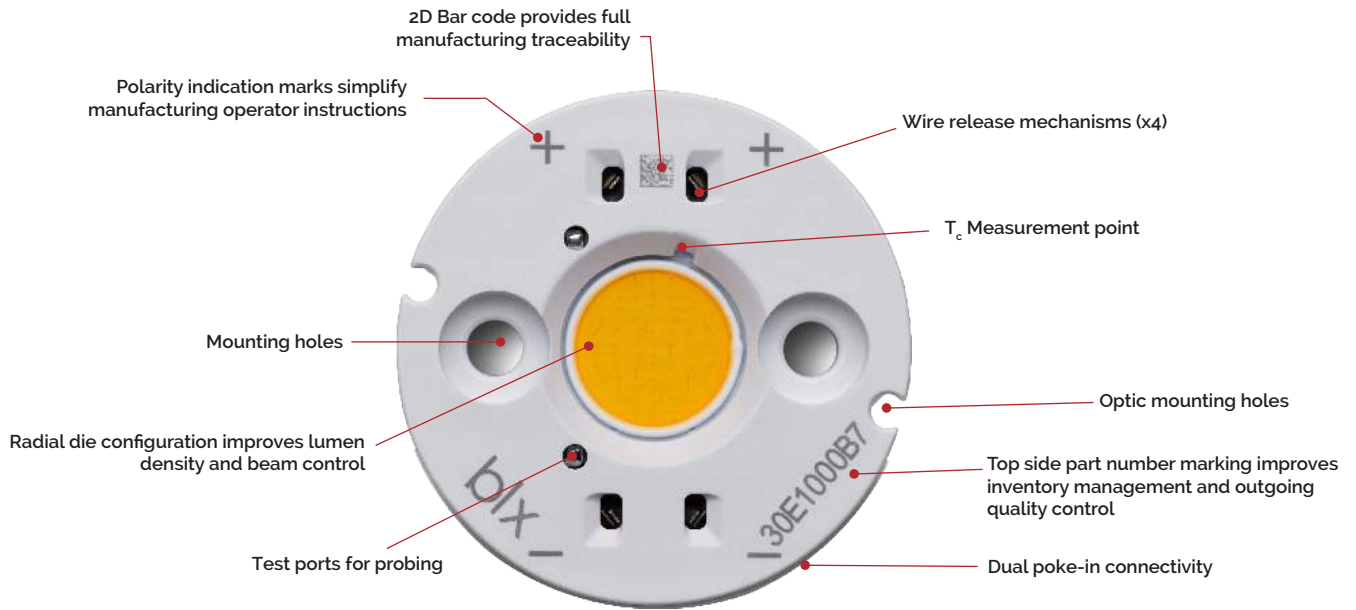

Product Nomenclature

The part number designation for Bridgelux Vero SE LED arrays is explained as follows:

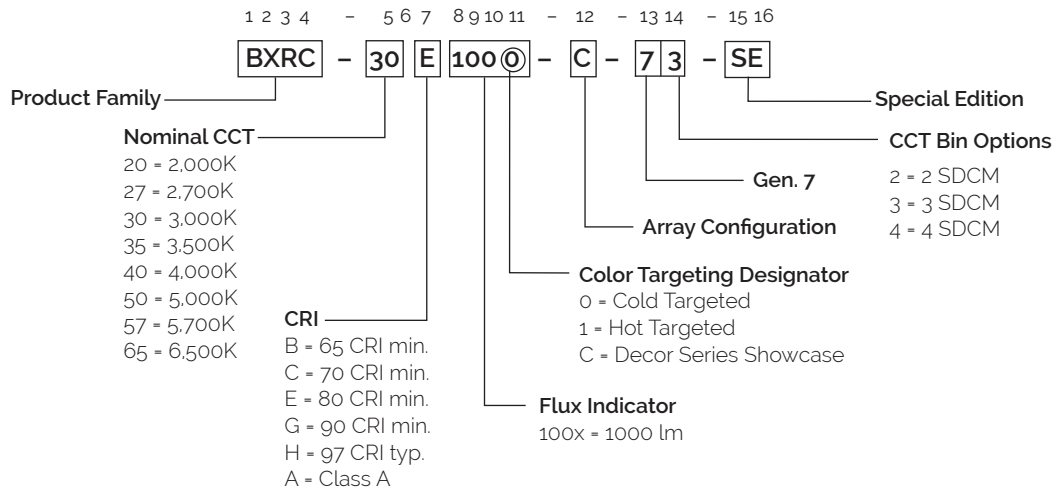

Product Selection Guide

The following product configurations are available:

Table 1: Selection Guide, Pulsed Measurement Data ($T_j = T_c = 25^\circ\text{C}$)

Part Number	Nominal CCT ¹ (K)	CRI ²	Nominal Drive Current ³ (mA)	Typical Pulsed Flux ^{4,5,6} $T_c = 25^\circ\text{C}$ (lm)	Minimum Pulsed Flux ^{6,7} $T_c = 25^\circ\text{C}$ (lm)	Typical V_f (V)	Typical Power (W)	Typical Efficacy (lm/W)
BXRC-20B1001-B-73-SE	2000	65	270	1325	1166	34.8	9.4	141
BXRC-20B1001-D-73-SE	2000	65	350	1283	1129	26.0	9.1	141
BXRC-27E1000-B-7x-SE	2700	80	270	1353	1191	34.8	9.4	144
BXRC-27E1000-C-7x-SE	2700	80	360	1804	1588	34.8	12.5	144
BXRC-27E1000-D-7x-SE	2700	80	350	1310	1153	26.0	9.1	144
BXRC-27G10H0-B-7x-SE	2700	90	270	1165	1025	34.8	9.4	124
BXRC-27G10H0-C-7x-SE	2700	90	360	1553	1367	34.8	12.5	124
BXRC-27G10H0-D-7x-SE	2700	90	350	1128	993	26.0	9.1	124
BXRC-27G1000-B-7x-SE	2700	90	270	1128	992	34.8	9.4	120
BXRC-27G1000-C-7x-SE	2700	90	360	1503	1323	34.8	12.5	120
BXRC-27G1000-D-7x-SE	2700	90	350	1092	961	26.0	9.1	120
BXRC-27H1000-B-7x-SE	2700	97	270	977	860	34.8	9.4	104
BXRC-27H1000-C-7x-SE	2700	97	360	1303	1147	34.8	12.5	104
BXRC-27H1000-D-7x-SE	2700	97	350	946	833	26.0	9.1	104
BXRC-30C1001-B-74-SE	3000	70	270	1550	1364	34.8	9.4	165
BXRC-30C1001-C-74-SE	3000	70	360	2067	1819	34.8	12.5	165
BXRC-30C1001-D-74-SE	3000	70	350	1502	1321	26.0	9.1	165
BXRC-30E1000-B-7x-SE	3000	80	270	1409	1240	34.8	9.4	150
BXRC-30E1000-C-7x-SE	3000	80	360	1879	1654	34.8	12.5	150
BXRC-30E1000-D-7x-SE	3000	80	350	1365	1201	26.0	9.1	150
BXRC-30G10H0-B-7x-SE	3000	90	270	1221	1075	34.8	9.4	130
BXRC-30G10H0-C-7x-SE	3000	90	360	1629	1433	34.8	12.5	130
BXRC-30G10H0-D-7x-SE	3000	90	350	1183	1041	26.0	9.1	130
BXRC-30G1000-B-7x-SE	3000	90	270	1175	1034	34.8	9.4	125
BXRC-30G1000-C-7x-SE	3000	90	360	1566	1378	34.8	12.5	125
BXRC-30G1000-D-7x-SE	3000	90	350	1138	1001	26.0	9.1	125
BXRC-30G100C-B-73-SE	3000	90	270	1090	959	34.8	9.4	116
BXRC-30G100C-D-73-SE	3000	90	350	1056	929	26.0	9.1	116
BXRC-30H1000-B-7x-SE	3000	97	270	1052	926	34.8	9.4	112
BXRC-30H1000-C-7x-SE	3000	97	360	1403	1235	34.8	12.5	112
BXRC-30H1000-D-7x-SE	3000	97	350	1019	897	26.0	9.1	112
BXRC-30A1001-B-73-SE ^{8,9}	3000	93	270	1062	934	34.8	9.4	113
BXRC-30A1001-C-73-SE ^{8,9}	3000	93	360	1416	1246	34.8	12.5	113
BXRC-30A1001-D-73-SE ^{8,9}	3000	93	350	1028	905	26.0	9.1	113

Notes for Table 1:

- Nominal CCT as defined by ANSI C78.377-2011. Products with a CCT of 5000K-6500K are hot targeted to $T_c = 85^\circ\text{C}$.
- CRI values are typical for Decor Series Ultra, Decor Series Street and Landmark and Decor Series Class A products. CRI values are minimums for all other products. Minimum Rg value for 80 CRI products is 0, the minimum Rg values for 90 CRI products is 50, the minimum Rg values for 97 CRI products is 93. Bridgelux maintains a ± 3 tolerance on CRI and Rg values.
- Drive current is referred to as nominal drive current.
- Products tested under pulsed condition (10ms pulse width) at nominal test current where T_j (junction temperature) - T_c (case temperature) = 25°C .
- Typical performance values are provided as a reference only and are not a guarantee of performance.
- Bridgelux maintains a $\pm 7\%$ tolerance on flux measurements.
- Minimum flux values at the nominal test current are guaranteed by 100% test.
- Nominal CCT is defined by the Lighting Research Center's Class A definition. The center of the Class A color bin is on the corresponding isothermal line.
- GAI value is 80. To help ensure optimal fixture level performance, GAI is measured at the fixture level, on axis, at a case temperature of 70°C . GAI may vary depending on fixture design and performance.

Product Selection Guide

Table 1: Selection Guide, Pulsed Measurement Data ($T_j = T_c = 25^\circ\text{C}$) (continued)

Part Number	Nominal CCT ¹ (K)	CRI ²	Nominal Drive Current ³ (mA)	Typical Pulsed Flux ^{4,5,6} $T_c = 25^\circ\text{C}$ (lm)	Minimum Pulsed Flux ^{6,7} $T_c = 25^\circ\text{C}$ (lm)	Typical V_f (V)	Typical Power (W)	Typical Efficacy (lm/W)
BXRC-35E1000-B-7x-SE	3500	80	270	1456	1282	34.8	9.4	155
BXRC-35E1000-C-7x-SE	3500	80	360	1942	1709	34.8	12.5	155
BXRC-35E1000-D-7x-SE	3500	80	350	1411	1241	26.0	9.1	155
BXRC-35G1000-B-7x-SE	3500	90	270	1212	1067	34.8	9.4	129
BXRC-35G1000-C-7x-SE	3500	90	360	1616	1422	34.8	12.5	129
BXRC-35G1000-D-7x-SE	3500	90	350	1174	1033	26.0	9.1	129
BXRC-35A1001-B-73-SE ^{8,9}	3500	93	270	1146	1009	34.8	9.4	122
BXRC-35A1001-C-73-SE ^{8,9}	3500	93	360	1528	1345	34.8	12.5	122
BXRC-35A1001-D-73-SE ^{8,9}	3500	93	350	1110	977	26.0	9.1	122
BXRC-40C1001-B-74-SE	4000	70	270	1579	1389	34.8	9.4	168
BXRC-40C1001-C-74-SE	4000	70	360	2105	1852	34.8	12.5	168
BXRC-40C1001-D-74-SE	4000	70	350	1529	1345	26.0	9.1	168
BXRC-40E1000-B-7x-SE	4000	80	270	1466	1290	34.8	9.4	156
BXRC-40E1000-C-7x-SE	4000	80	360	1954	1720	34.8	12.5	156
BXRC-40E1000-D-7x-SE	4000	80	350	1420	1249	26.0	9.1	156
BXRC-40G1000-B-7x-SE	4000	90	270	1259	1108	34.8	9.4	134
BXRC-40G1000-C-7x-SE	4000	90	360	1679	1477	34.8	12.5	134
BXRC-40G1000-D-7x-SE	4000	90	350	1219	1073	26.0	9.1	134
BXRC-40H1000-B-7x-SE	4000	97	270	1081	951	34.8	9.4	115
BXRC-40H1000-C-7x-SE	4000	97	360	1441	1268	34.8	12.5	115
BXRC-40H1000-D-7x-SE	4000	97	350	1047	921	26.0	9.1	115
BXRC-40A1001-B-73-SE ^{8,9}	4000	93	270	1212	1067	34.8	9.4	129
BXRC-40A1001-C-73-SE ^{8,9}	4000	93	360	1616	1422	34.8	12.5	129
BXRC-40A1001-D-73-SE ^{8,9}	4000	93	350	1174	1033	26.0	9.1	129
BXRC-50C1001-B-7x-SE	5000	70	270	1607	1414	34.8	9.4	171
BXRC-50C1001-C-7x-SE	5000	70	360	2142	1885	34.8	12.5	171
BXRC-50C1001-D-7x-SE	5000	70	350	1556	1369	26.0	9.1	171
BXRC-50E1001-B-7x-SE	5000	80	270	1513	1331	34.8	9.4	161
BXRC-50E1001-C-7x-SE	5000	80	360	2017	1775	34.8	12.5	161
BXRC-50E1001-D-7x-SE	5000	80	350	1465	1289	26.0	9.1	161
BXRC-50G1001-B-7x-SE	5000	90	270	1278	1125	34.8	9.4	136
BXRC-50G1001-C-7x-SE	5000	90	360	1704	1499	34.8	12.5	136
BXRC-50G1001-D-7x-SE	5000	90	350	1238	1089	26.0	9.1	136

Notes for Table 1:

- Nominal CCT as defined by ANSI C78.377-2011. Products with a CCT of 5000K-6500K are hot targeted to $T_c = 85^\circ\text{C}$.
- CRI values are typical for Decor Series Ultra, Decor Series Street and Landmark and Decor Series Class A products. CRI values are minimums for all other products. Minimum R9 value for 80 CRI products is 0, the minimum R9 values for 90 CRI products is 50, the minimum R9 values for 97 CRI products is 93. Bridgelux maintains a ± 3 tolerance on CRI and R9 values.
- Drive current is referred to as nominal drive current.
- Products tested under pulsed condition (10ms pulse width) at nominal test current where T_j (junction temperature) - T_c (case temperature) = 25°C .
- Typical performance values are provided as a reference only and are not a guarantee of performance.
- Bridgelux maintains a $\pm 7\%$ tolerance on flux measurements.
- Minimum flux values at the nominal test current are guaranteed by 100% test.
- Nominal CCT is defined by the Lighting Research Center's Class A definition. The center of the Class A color bin is on the corresponding isothermal line.
- GAI value is 80. To help ensure optimal fixture level performance, GAI is measured at the fixture level, on axis, at a case temperature of 70°C . GAI may vary depending on fixture design and performance.

Product Selection Guide

Table 1: Selection Guide, Pulsed Measurement Data ($T_j = T_c = 25^\circ\text{C}$) (continued)

Part Number	Nominal CCT ¹ (K)	CRI ²	Nominal Drive Current ³ (mA)	Typical Pulsed Flux ^{4,5,6} $T_c = 25^\circ\text{C}$ (lm)	Minimum Pulsed Flux ^{6,7} $T_c = 25^\circ\text{C}$ (lm)	Typical V_f (V)	Typical Power (W)	Typical Efficacy (lm/W)
BXRC-57C1001-B-7x-SE	5700	70	270	1550	1364	34.8	9.4	165
BXRC-57C1001-C-7x-SE	5700	70	360	2067	1819	34.8	12.5	165
BXRC-57C1001-D-7x-SE	5700	70	350	1502	1321	26.0	9.1	165
BXRC-57E1001-B-7x-SE	5700	80	270	1494	1315	34.8	9.4	159
BXRC-57E1001-C-7x-SE	5700	80	360	1992	1753	34.8	12.5	159
BXRC-57E1001-D-7x-SE	5700	80	350	1447	1273	26.0	9.1	159
BXRC-65C1001-B-7x-SE	6500	70	270	1579	1389	34.8	9.4	168
BXRC-65C1001-C-7x-SE	6500	70	360	2105	1852	34.8	12.5	168
BXRC-65C1001-D-7x-SE	6500	70	350	1529	1345	26.0	9.1	168
BXRC-65E1001-B-7x-SE	6500	80	270	1522	1339	34.8	9.4	162
BXRC-65E1001-C-7x-SE	6500	80	360	2030	1786	34.8	12.5	162
BXRC-65E1001-D-7x-SE	6500	80	350	1474	1297	26.0	9.1	162

Notes for Table 1:

- Nominal CCT as defined by ANSI C78.377-2011. Products with a CCT of 5000K-6500K are hot targeted to $T_c = 85^\circ\text{C}$.
- CRI values are typical for Decor Series Ultra, Decor Series Street and Landmark and Decor Series Class A products. CRI values are minimums for all other products. Minimum Rg value for 80 CRI products is 0, the minimum Rg value for 90 CRI products is 50, the minimum Rg values for 97 CRI products is 93. Bridgelux maintains a ± 3 tolerance on CRI and Rg values.
- Drive current is referred to as nominal drive current.
- Products tested under pulsed condition (10ms pulse width) at nominal test current where T_j (junction temperature) - T_c (case temperature) = 25°C .
- Typical performance values are provided as a reference only and are not a guarantee of performance.
- Bridgelux maintains a $\pm 7\%$ tolerance on flux measurements.
- Minimum flux values at the nominal test current are guaranteed by 100% test.
- Nominal CCT is defined by the Lighting Research Center's Class A definition. The center of the Class A color bin is on the corresponding isothermal line.
- GAI value is 80. To help ensure optimal fixture level performance, GAI is measured at the fixture level, on axis, at a case temperature of 70°C . GAI may vary depending on fixture design and performance.

Product Selection Guide

Table 2: Selection Guide, Stabilized DC Performance ($T_c = 70^\circ\text{C}$) ^{7,8}

Part Number	Nominal CCT ¹ (K)	GAI ²	CRI ³	Nominal Drive Current ⁴ (mA)	Typical DC Flux ^{5,6} $T_c = 70^\circ\text{C}$ (lm)	Minimum DC Flux ^{6,9} $T_c = 70^\circ\text{C}$ (lm)	Typical V_f (V)	Typical Power (W)	Typical Efficacy (lm/W)
BXRC-30A1001-B-73	3000	80	93	270	987	869	34.3	9.3	107
BXRC-30A1001-C-73	3000	80	93	360	1317	1159	34.3	12.3	107
BXRC-30A1001-D-73	3000	80	93	350	956	842	25.5	8.9	107
BXRC-35A1001-B-73	3500	80	93	270	1066	938	34.3	9.3	115
BXRC-35A1001-C-73	3500	80	93	360	1421	1251	34.3	12.3	115
BXRC-35A1001-D-73	3500	80	93	350	1032	909	25.5	8.9	116
BXRC-40A1001-B-73	4000	80	93	270	1127	992	34.3	9.3	122
BXRC-40A1001-C-73	4000	80	93	360	1503	1323	34.3	12.3	122
BXRC-40A1001-D-73	4000	80	93	350	1092	961	25.5	8.9	122

Notes for Table 2:

- Nominal CCT is defined by the Lighting Research Center's Class A definition. The center of the Class A color bin is on the corresponding isothermal line.
- To help ensure optimal fixture level performance, GAI is measured at the fixture level, on axis, at a case temperature of 70°C . GAI may vary depending on fixture design and performance.
- CRI Values are specified as typical.
- Drive current is referred to as nominal drive current.
- Typical performance values are provided as a reference only and are not a guarantee of performance.
- Bridgelux maintains a $\pm 7\%$ tolerance on flux measurements.
- Typical stabilized DC performance values are provided as reference only and are not a guarantee of performance.
- Typical performance is estimated based on operation under DC (direct current) with LED array mounted onto a heat sink with thermal interface material and the case temperature maintained at specified temperature. Based on Bridgelux test setup, values may vary depending on the thermal design of the luminaire and/or the exposed environment to which the product is subjected.
- Minimum flux values at elevated temperatures are provided for reference only and are not guaranteed by 100% production testing. Based on Bridgelux test setup, values may vary depending on the thermal design of the luminaire and/or the exposed environment to which the product is subjected.

Product Selection Guide

Table 3: Selection Guide, Stabilized DC Performance ($T_c = 85^\circ\text{C}$)^{4,5}

Part Number	Nominal CCT ¹ (K)	CRI ²	Nominal Drive Current ³ (mA)	Typical DC Flux ^{4,5} $T_c = 85^\circ\text{C}$ (lm)	Minimum DC Flux ⁶ $T_c = 85^\circ\text{C}$ (lm)	Typical V_f (V)	Typical Power (W)	Typical Efficacy (lm/W)
BXRC-20B1001-B-73-SE	2000	65	270	1192	1049	33.8	9.1	131
BXRC-20B1001-D-73-SE	2000	65	350	1155	1016	25.3	8.9	130
BXRC-27E1000-B-7x-SE	2700	80	270	1218	1072	33.8	9.1	133
BXRC-27E1000-C-7x-SE	2700	80	360	1624	1429	33.8	12.2	133
BXRC-27E1000-D-7x-SE	2700	80	350	1179	1038	25.3	8.9	133
BXRC-27G10H0-B-7x-SE	2700	90	270	1049	923	33.8	9.1	115
BXRC-27G10H0-C-7x-SE	2700	90	360	1398	1230	33.8	12.2	115
BXRC-27G10H0-D-7x-SE	2700	90	350	1016	894	25.3	8.9	115
BXRC-27G1000-B-7x-SE	2700	90	270	1015	893	33.8	9.1	111
BXRC-27G1000-C-7x-SE	2700	90	360	1353	1191	33.8	12.2	111
BXRC-27G1000-D-7x-SE	2700	90	350	983	865	25.3	8.9	111
BXRC-27H1000-B-7x-SE	2700	97	270	879	774	33.8	9.1	96
BXRC-27H1000-C-7x-SE	2700	97	360	1173	1032	33.8	12.2	96
BXRC-27H1000-D-7x-SE	2700	97	350	852	750	25.3	8.9	96
BXRC-30C1001-B-74-SE	3000	70	270	1395	1228	33.8	9.1	153
BXRC-30C1001-C-74-SE	3000	70	360	1860	1637	33.8	12.2	153
BXRC-30C1001-D-74-SE	3000	70	350	1351	1189	25.3	8.9	153
BXRC-30E1000-B-7x-SE	3000	80	270	1268	1116	33.8	9.1	139
BXRC-30E1000-C-7x-SE	3000	80	360	1691	1488	33.8	12.2	139
BXRC-30E1000-D-7x-SE	3000	80	350	1229	1081	25.3	8.9	139
BXRC-30G10H0-B-7x-SE	3000	90	270	1099	967	33.8	9.1	120
BXRC-30G10H0-C-7x-SE	3000	90	360	1466	1290	33.8	12.2	120
BXRC-30G10H0-D-7x-SE	3000	90	350	1065	937	25.3	8.9	120
BXRC-30G1000-B-7x-SE	3000	90	270	1057	930	33.8	9.1	116
BXRC-30G1000-C-7x-SE	3000	90	360	1409	1240	33.8	12.2	116
BXRC-30G1000-D-7x-SE	3000	90	350	1024	901	25.3	8.9	116
BXRC-30G100C-B-73-SE	3000	90	270	981	863	34.0	9.2	107
BXRC-30G100C-D-73-SE	3000	90	350	950	836	25.3	8.9	107
BXRC-30H1000-B-7x-SE	3000	97	270	947	833	33.8	9.1	104
BXRC-30H1000-C-7x-SE	3000	97	360	1263	1111	33.8	12.2	104
BXRC-30H1000-D-7x-SE	3000	97	350	917	807	25.3	8.9	104
BXRC-30A1001-B-73-SE ^{7,8}	3000	93	270	956	841	33.8	9.1	105
BXRC-30A1001-C-73-SE ^{7,8}	3000	93	360	1274	1121	33.8	12.2	105
BXRC-30A1001-D-73-SE ^{7,8}	3000	93	350	925	814	25.3	8.9	105

Notes for Table 3:

- Nominal CCT as defined by ANSI C78.377-2011. Products with a CCT of 5000K-6500K are hot targeted to $T_c = 85^\circ\text{C}$.
- All CRI values are measured at $T_j = T_c = 25^\circ\text{C}$. CRI values are typical for Decor Series Ultra, Decor Series Street and Landmark and Decor Series Class A products. CRI values are minimums for all other products. Minimum Rg value for 80 CRI products is 0, the minimum Rg values for 90 CRI products is 50, the minimum Rg values for 97 CRI products is 93. Bridgelux maintains a ± 3 tolerance on CRI and Rg values.
- Drive current is referred to as nominal drive current.
- Typical stabilized DC performance values are provided as reference only and are not a guarantee of performance.
- Typical performance is estimated based on operation under DC (direct current) with LED array mounted onto a heat sink with thermal interface material and the case temperature maintained at 85°C . Based on Bridgelux test setup, values may vary depending on the thermal design of the luminaire and/or the exposed environment to which the product is subjected.
- Minimum flux values at elevated temperatures are provided for reference only and are not guaranteed by 100% production testing. Based on Bridgelux test setup, values may vary depending on the thermal design of the luminaire and/or the exposed environment to which the product is subjected.
- Nominal CCT is defined by the Lighting Research Center's Class A definition. The center of the Class A color bin is on the corresponding isothermal line.
- GAI value is 80. To help ensure optimal fixture level performance, GAI is measured at the fixture level, on axis, at a case temperature of 70°C . GAI may vary depending on fixture design and performance.

Product Selection Guide

Table 3: Selection Guide, Stabilized DC Performance ($T_c = 85^\circ\text{C}$)^{4,5} (continued)

Part Number	Nominal CCT ¹ (K)	CRI ²	Nominal Drive Current ³ (mA)	Typical DC Flux ^{4,5} $T_c = 85^\circ\text{C}$ (lm)	Minimum DC Flux ⁶ $T_c = 85^\circ\text{C}$ (lm)	Typical V_f (V)	Typical Power (W)	Typical Efficacy (lm/W)
BXRC-35E1000-B-7x-SE	3500	80	270	1311	1153	33.8	9.1	143
BXRC-35E1000-C-7x-SE	3500	80	360	1748	1538	33.8	12.2	143
BXRC-35E1000-D-7x-SE	3500	80	350	1269	1117	25.3	8.9	143
BXRC-35G1000-B-7x-SE	3500	90	270	1091	960	33.8	9.1	119
BXRC-35G1000-C-7x-SE	3500	90	360	1455	1280	33.8	12.2	119
BXRC-35G1000-D-7x-SE	3500	90	350	1057	930	25.3	8.9	119
BXRC-35A1001-B-73-SE ^{7,8}	3500	93	270	1032	908	33.8	9.1	113
BXRC-35A1001-C-73-SE ^{7,8}	3500	93	360	1376	1211	33.8	12.2	113
BXRC-35A1001-D-73-SE ^{7,8}	3500	93	350	999	879	25.3	8.9	113
BXRC-40C1001-B-74-SE	4000	70	270	1421	1250	33.8	9.1	156
BXRC-40C1001-C-74-SE	4000	70	360	1894	1667	^{7,8} 33.8	12.2	156
BXRC-40C1001-D-74-SE	4000	70	350	1376	1211	25.3	8.9	155
BXRC-40E1000-B-7x-SE	4000	80	270	1319	1161	33.8	9.1	144
BXRC-40E1000-C-7x-SE	4000	80	360	1759	1548	33.8	12.2	144
BXRC-40E1000-D-7x-SE	4000	80	350	1278	1124	25.3	8.9	144
BXRC-40G1000-B-7x-SE	4000	90	270	1133	997	33.8	9.1	124
BXRC-40G1000-C-7x-SE	4000	90	360	1511	1330	33.8	12.2	124
BXRC-40G1000-D-7x-SE	4000	90	350	1097	966	25.3	8.9	124
BXRC-40H1000-B-7x-SE	4000	97	270	972	856	33.8	9.1	106
BXRC-40H1000-C-7x-SE	4000	97	360	1297	1141	33.8	12.2	106
BXRC-40H1000-D-7x-SE	4000	97	350	942	829	25.3	8.9	106
BXRC-40A1001-B-73-SE ^{7,8}	4000	93	270	1091	960	33.8	9.1	119
BXRC-40A1001-C-73-SE ^{7,8}	4000	93	360	1455	1280	33.8	12.2	119
BXRC-40A1001-D-73-SE ^{7,8}	4000	93	350	1057	930	25.3	8.9	119
BXRC-50C1001-B-7x-SE	5000	70	270	1446	1273	33.8	9.1	158
BXRC-50C1001-C-7x-SE	5000	70	360	1928	1697	33.8	12.2	158
BXRC-50C1001-D-7x-SE	5000	70	350	1400	1232	25.3	8.9	158
BXRC-50E1001-B-7x-SE	5000	80	270	1361	1198	33.8	9.1	149
BXRC-50E1001-C-7x-SE	5000	80	360	1815	1597	33.8	12.2	149
BXRC-50E1001-D-7x-SE	5000	80	350	1319	1160	25.3	8.9	149
BXRC-50G1001-B-7x-SE	5000	90	270	1150	1012	33.8	9.1	126
BXRC-50G1001-C-7x-SE	5000	90	360	1533	1349	33.8	12.2	126
BXRC-50G1001-D-7x-SE	5000	90	350	1114	980	25.3	8.9	126

Notes for Table 3:

- Nominal CCT as defined by ANSI C78.377-2011. Products with a CCT of 5000K-6500K are hot targeted to $T_c = 85^\circ\text{C}$.
- All CRI values are measured at $T_s = T_c = 25^\circ\text{C}$. CRI values are typical for Decor Series Ultra, Decor Series Street and Landmark and Decor Series Class A products. CRI values are minimums for all other products. Minimum R_g value for 80 CRI products is 0, the minimum R_g values for 90 CRI products is 50, the minimum R_g values for 97 CRI products is 93. Bridgelux maintains a ± 3 tolerance on CRI and R_g values.
- Drive current is referred to as nominal drive current.
- Typical stabilized DC performance values are provided as reference only and are not a guarantee of performance.
- Typical performance is estimated based on operation under DC (direct current) with LED array mounted onto a heat sink with thermal interface material and the case temperature maintained at 85°C . Based on Bridgelux test setup, values may vary depending on the thermal design of the luminaire and/or the exposed environment to which the product is subjected.
- Minimum flux values at elevated temperatures are provided for reference only and are not guaranteed by 100% production testing. Based on Bridgelux test setup, values may vary depending on the thermal design of the luminaire and/or the exposed environment to which the product is subjected.
- Nominal CCT is defined by the Lighting Research Center's Class A definition. The center of the Class A color bin is on the corresponding isothermal line.
- GAI value is 80. To help ensure optimal fixture level performance, GAI is measured at the fixture level, on axis, at a case temperature of 70°C . GAI may vary depending on fixture design and performance.

Product Selection Guide

Table 3: Selection Guide, Stabilized DC Performance ($T_c = 85^\circ\text{C}$)^{4,5} (continued)

Part Number	Nominal CCT ¹ (K)	CRI ²	Nominal Drive Current ³ (mA)	Typical DC Flux ^{4,5} $T_c = 85^\circ\text{C}$ (lm)	Minimum DC Flux ⁶ $T_c = 85^\circ\text{C}$ (lm)	Typical V_f (V)	Typical Power (W)	Typical Efficacy (lm/W)
BXRC-57C1001-B-7x-SE	5700	70	270	1395	1228	33.8	9.1	153
BXRC-57C1001-C-7x-SE	5700	70	360	1860	1637	33.8	12.2	153
BXRC-57C1001-D-7x-SE	5700	70	350	1351	1189	25.3	8.9	153
BXRC-57E1001-B-7x-SE	5700	80	270	1345	1183	33.8	9.1	147
BXRC-57E1001-C-7x-SE	5700	80	360	1793	1578	33.8	12.2	147
BXRC-57E1001-D-7x-SE	5700	80	350	1302	1146	25.3	8.9	147
BXRC-65C1001-B-7x-SE	6500	70	270	1421	1250	33.8	9.1	156
BXRC-65C1001-C-7x-SE	6500	70	360	1894	1667	33.8	12.2	156
BXRC-65C1001-D-7x-SE	6500	70	350	1376	1211	25.3	8.9	155
BXRC-65E1001-B-7x-SE	6500	80	270	1370	1206	33.8	9.1	150
BXRC-65E1001-C-7x-SE	6500	80	360	1827	1607	33.8	12.2	150
BXRC-65E1001-D-7x-SE	6500	80	350	1327	1168	25.3	8.9	150

Notes for Table 3:

- Nominal CCT as defined by ANSI C78.377-2011. Products with a CCT of 5000K-6500K are hot targeted to $T_c = 85^\circ\text{C}$.
- All CRI values are measured at $T_c = T_a = 25^\circ\text{C}$. CRI values are typical for Decor Series Ultra, Decor Series Street and Landmark and Decor Series Class A products. CRI values are minimums for all other products. Minimum Rg value for 80 CRI products is 0, the minimum Rg values for 90 CRI products is 50, the minimum Rg values for 97 CRI products is 93. Bridgelux maintains a ± 3 tolerance on CRI and Rg values.
- Drive current is referred to as nominal drive current.
- Typical stabilized DC performance values are provided as reference only and are not a guarantee of performance.
- Typical performance is estimated based on operation under DC (direct current) with LED array mounted onto a heat sink with thermal interface material and the case temperature maintained at 85°C . Based on Bridgelux test setup, values may vary depending on the thermal design of the luminaire and/or the exposed environment to which the product is subjected.
- Minimum flux values at elevated temperatures are provided for reference only and are not guaranteed by 100% production testing. Based on Bridgelux test setup, values may vary depending on the thermal design of the luminaire and/or the exposed environment to which the product is subjected.
- Nominal CCT is defined by the Lighting Research Center's Class A definition. The center of the Class A color bin is on the corresponding isothermal line.
- GAI value is 80. To help ensure optimal fixture level performance, GAI is measured at the fixture level, on axis, at a case temperature of 70°C . GAI may vary depending on fixture design and performance.

Performance at Commonly Used Drive Currents

Vero SE LED arrays are tested to the specifications shown using the nominal drive currents in Table 1. Vero SE may also be driven at other drive currents dependent on specific application design requirements. The performance at any drive current can be derived from the current vs. voltage characteristics shown in Figures 1, 2 & 3 and the flux vs. current characteristics shown in Figures 4, 5 & 6. The performance at commonly used drive currents is summarized in Table 4.

Table 4: Product Performance at Commonly Used Drive Currents

Part Number	CRI	Drive Current ¹ (mA)	Typical V_f $T_c = 25^\circ\text{C}$ (V)	Typical Power $T_c = 25^\circ\text{C}$ (W)	Typical Flux ² $T_c = 25^\circ\text{C}$ (lm)	Typical DC Flux ³ $T_c = 85^\circ\text{C}$ (lm)	Typical Efficacy $T_c = 25^\circ\text{C}$ (lm/W)
BXRC-20B1001-B-73-SE	65	135	33.1	4.5	706	634	158
		180	33.6	6.1	926	830	153
		270	34.8	9.4	1325	1192	141
		405	36.2	14.7	1944	1729	132
		540	37.5	20.3	2490	2204	123
BXRC-20B1001-D-73-SE	65	175	24.9	4.4	685	623	157
		233	25.4	5.9	899	808	152
		350	26.0	9.1	1283	1155	141
		525	27.4	14.4	1889	1629	131
		700	28.4	19.9	2420	2038	122
BXRC-27E1000-B-7x-SE	80	135	33.1	4.5	721	648	162
		180	33.6	6.1	945	848	156
		270	34.8	9.4	1353	1218	144
		405	36.2	14.7	1985	1766	135
		540	37.5	20.3	2543	2251	125
BXRC-27E1000-C-7x-SE	80	180	33.1	6.0	959	856	161
		240	33.6	8.1	1257	1116	156
		360	34.8	12.5	1804	1624	144
		540	36.2	19.5	2627	2282	134
		720	37.5	27.0	3356	2872	124
BXRC-27E1000-D-7x-SE	80	175	24.9	4.4	700	636	160
		233	25.4	5.9	918	825	155
		350	26.0	9.1	1310	1179	144
		525	27.4	14.4	1929	1664	134
		700	28.4	19.9	2471	2081	124
BXRC-27G10H0-B-7x-SE	90	135	33.1	4.5	621	558	139
		180	33.6	6.1	814	730	134
		270	34.8	9.4	1165	1268	124
		405	36.2	14.7	1709	1521	116
		540	37.5	20.3	2190	1938	108
BXRC-27G10H0-C-7x-SE	90	180	33.1	6.0	826	737	139
		240	33.6	8.1	1082	961	134
		360	34.8	12.5	1553	1691	124
		540	36.2	19.5	2262	1965	116
		720	37.5	27.0	2890	2473	107
BXRC-27G10H0-D-7x-SE	90	175	24.9	4.4	602	548	138
		233	25.4	5.9	790	711	134
		350	26.0	9.1	1128	1229	124
		525	27.4	14.4	1661	1433	116
		700	28.4	19.9	2128	1792	107

Notes for Table 4:

1. Alternate drive currents are provided for reference only and are not a guarantee of performance.
2. Bridgelux maintains a $\pm 7\%$ tolerance on flux measurements.
3. Typical stabilized DC performance values are provided as reference only and are not a guarantee of performance.

Performance at Commonly Used Drive Currents

Table 4: Product Performance at Commonly Used Drive Currents (Continued)

Part Number	CRI	Drive Current ¹ (mA)	Typical V _f T _c = 25°C (V)	Typical Power T _c = 25°C (W)	Typical Flux ² T _c = 25°C (lm)	Typical DC Flux ³ T _c = 85°C (lm)	Typical Efficacy T _c = 25°C (lm/W)
BXRC-27G1000-B-7x-SE	90	135	33.1	4.5	601	540	135
		180	33.6	6.1	788	707	130
		270	34.8	9.4	1128	1015	120
		405	36.2	14.7	1654	1471	113
		540	37.5	20.3	2119	1876	105
BXRC-27G1000-C-7x-SE	90	180	33.1	6.0	799	713	134
		240	33.6	8.1	1047	930	130
		360	34.8	12.5	1503	1353	120
		540	36.2	19.5	2189	1902	112
BXRC-27G1000-D-7x-SE	90	720	37.5	27.0	2796	2394	104
		175	24.9	4.4	583	530	134
		233	25.4	5.9	765	688	129
		350	26.0	9.1	1092	983	120
BXRC-27G1000-D-7x-SE	90	525	27.4	14.4	1607	1386	112
		700	28.4	19.9	2059	1734	104
		135	33.1	4.5	521	468	117
		180	33.6	6.1	683	612	113
BXRC-27H1000-B-7x-SE	97	270	34.8	9.4	977	879	104
		405	36.2	14.7	1434	1275	98
		540	37.5	20.3	1837	1626	91
		180	33.1	6.0	693	618	116
		240	33.6	8.1	908	806	112
BXRC-27H1000-C-7x-SE	97	360	34.8	12.5	1303	1173	104
		540	36.2	19.5	1897	1648	97
		720	37.5	27.0	2423	2075	90
		175	24.9	4.4	505	459	116
BXRC-27H1000-D-7x-SE	97	233	25.4	5.9	663	596	112
		350	26.0	9.1	946	852	104
		525	27.4	14.4	1393	1201	97
		700	28.4	19.9	1785	1503	90
BXRC-30C1001-B-7x-SE	70	135	33.1	4.5	826	742	185
		180	33.6	6.1	1083	972	179
		270	34.8	9.4	1550	1395	165
		405	36.2	14.7	2274	2023	155
		540	37.5	20.3	2914	2579	144
BXRC-30C1001-C-7x-SE	70	180	33.1	6.0	1099	981	184
		240	33.6	8.1	1440	1279	178
		360	34.8	12.5	2067	1860	165
		540	36.2	19.5	3010	2615	154
		720	37.5	27.0	3845	3291	142
BXRC-30C1001-D-7x-SE	70	175	24.9	4.4	802	729	184
		233	25.4	5.9	1052	946	178
		350	26.0	9.1	1502	1351	165
		525	27.4	14.4	2210	1906	154
		700	28.4	19.9	2832	2384	142

Notes for Table 4:

1. Alternate drive currents are provided for reference only and are not a guarantee of performance.
2. Bridgelux maintains a ± 7% tolerance on flux measurements.
3. Typical stabilized DC performance values are provided as reference only and are not a guarantee of performance.

Performance at Commonly Used Drive Currents

Table 4: Product Performance at Commonly Used Drive Currents (Continued)

Part Number	CRI	Drive Current ¹ (mA)	Typical V _f T _c = 25°C (V)	Typical Power T _c = 25°C (W)	Typical Flux ² T _c = 25°C (lm)	Typical DC Flux ³ T _c = 85°C (lm)	Typical Efficacy T _c = 25°C (lm/W)
BXRC-30E1000-B-7x-SE	80	135	33.1	4.5	751	675	168
		180	33.6	6.1	985	883	163
		270	34.8	9.4	1409	1268	150
		405	36.2	14.7	2068	1839	141
		540	37.5	20.3	2649	2345	131
BXRC-30E1000-C-7x-SE	80	180	33.1	6.0	999	892	168
		240	33.6	8.1	1309	1163	162
		360	34.8	12.5	1879	1691	150
		540	36.2	19.5	2736	2377	140
		720	37.5	27.0	3495	2992	129
BXRC-30E1000-D-7x-SE	80	175	24.9	4.4	729	663	167
		233	25.4	5.9	956	860	162
		350	26.0	9.1	1365	1229	150
		525	27.4	14.4	2009	1733	140
		700	28.4	19.9	2574	2168	129
BXRC-30G10H0-B-7x-SE	90	135	33.1	4.5	651	585	146
		180	33.6	6.1	853	766	141
		270	34.8	9.4	1221	1099	130
		405	36.2	14.7	1792	1594	122
		540	37.5	20.3	2296	2032	113
BXRC-30G10H0-C-7x-SE	90	180	33.1	6.0	866	773	145
		240	33.6	8.1	1134	1008	141
		360	34.8	12.5	1629	1466	130
		540	36.2	19.5	2372	2060	121
		720	37.5	27.0	3029	2593	112
BXRC-30G10H0-D-7x-SE	90	175	24.9	4.4	632	574	145
		233	25.4	5.9	829	745	140
		350	26.0	9.1	1183	1065	130
		525	27.4	14.4	1741	1502	121
		700	28.4	19.9	2231	1879	112
BXRC-30G1000-B-7x-SE	90	135	33.1	4.5	626	562	140
		180	33.6	6.1	821	736	136
		270	34.8	9.4	1175	1057	125
		405	36.2	14.7	1723	1533	117
		540	37.5	20.3	2207	1954	109
BXRC-30G1000-C-7x-SE	90	180	33.1	6.0	833	743	140
		240	33.6	8.1	1091	969	135
		360	34.8	12.5	1566	1409	125
		540	36.2	19.5	2280	1981	117
		720	37.5	27.0	2913	2493	108
BXRC-30G1000-D-7x-SE	90	175	24.9	4.4	607	552	139
		233	25.4	5.9	797	716	135
		350	26.0	9.1	1138	1024	125
		525	27.4	14.4	1674	1444	117
		700	28.4	19.9	2145	1806	108

Notes for Table 4:

1. Alternate drive currents are provided for reference only and are not a guarantee of performance.
2. Bridgelux maintains a ± 7% tolerance on flux measurements.
3. Typical stabilized DC performance values are provided as reference only and are not a guarantee of performance.

Performance at Commonly Used Drive Currents

Table 4: Product Performance at Commonly Used Drive Currents (Continued)

Part Number	CRI	Drive Current ¹ (mA)	Typical V _f T _c = 25°C (V)	Typical Power T _c = 25°C (W)	Typical Flux ² T _c = 25°C (lm)	Typical DC Flux ³ T _c = 85°C (lm)	Typical Efficacy T _c = 25°C (lm/W)
BXRC-30G100C-B-73-SE	90	135	33.1	4.5	581	522	130
		180	33.6	6.1	762	683	126
		270	34.8	9.4	1090	981	116
		405	36.2	14.7	1599	1422	109
		540	37.5	20.3	2049	1813	101
BXRC-30G100C-D-73-SE	90	175	24.9	4.4	564	512	129
		233	25.4	5.9	739	665	125
		350	26.0	9.1	1056	950	116
		525	27.4	14.4	1554	1340	108
		700	28.4	19.9	1991	1676	100
BXRC-30H1000-B-7x-SE	97	135	33.1	4.5	561	504	126
		180	33.6	6.1	735	660	121
		270	34.8	9.4	1052	947	112
		405	36.2	14.7	1544	1373	105
		540	37.5	20.3	1978	1751	98
BXRC-30H1000-C-7x-SE	97	180	33.1	6.0	746	666	125
		240	33.6	8.1	977	868	121
		360	34.8	12.5	1403	1263	112
		540	36.2	19.5	2043	1775	105
		720	37.5	27.0	2610	2234	97
BXRC-30H1000-D-7x-SE	97	175	24.9	4.4	544	495	125
		233	25.4	5.9	714	642	121
		350	26.0	9.1	1019	917	112
		525	27.4	14.4	1500	1294	104
		700	28.4	19.9	1922	1618	97
BXRC-30A1001-B-73	93	135	33.1	4.5	566	508	127
		180	33.6	6.1	742	665	123
		270	34.8	9.4	1062	956	113
		405	36.2	14.7	1558	1386	106
		540	37.5	20.3	1996	1766	98
BXRC-30A1001-C-73	93	180	33.1	6.0	753	672	126
		240	33.6	8.1	986	876	122
		360	34.8	12.5	1416	1274	113
		540	36.2	19.5	2061	1791	105
		720	37.5	27.0	2633	2254	98
BXRC-30A1001-D-73	93	175	24.9	4.4	549	499	126
		233	25.4	5.9	720	648	122
		350	26.0	9.1	1028	925	113
		525	27.4	14.4	1514	1305	105
		700	28.4	19.9	1939	1633	97
BXRC-35E1000-B-7x-SE	80	135	33.1	4.5	776	697	174
		180	33.6	6.1	1018	913	168
		270	34.8	9.4	1456	1311	155
		405	36.2	14.7	2137	1901	146
		540	37.5	20.3	2737	2423	135

Notes for Table 4:

1. Alternate drive currents are provided for reference only and are not a guarantee of performance.
2. Bridgelux maintains a ± 7% tolerance on flux measurements.
3. Typical stabilized DC performance values are provided as reference only and are not a guarantee of performance.

Performance at Commonly Used Drive Currents

Table 4: Product Performance at Commonly Used Drive Currents (Continued)

Part Number	CRI	Drive Current ¹ (mA)	Typical V _f T _c = 25°C (V)	Typical Power T _c = 25°C (W)	Typical Flux ² T _c = 25°C (lm)	Typical DC Flux ³ T _c = 85°C (lm)	Typical Efficacy T _c = 25°C (lm/W)
BXRC-35E1000-C-7x-SE	80	180	33.1	6.0	1032	921	173
		240	33.6	8.1	1353	1202	168
		360	34.8	12.5	1942	1748	155
		540	36.2	19.5	2828	2456	145
		720	37.5	27.0	3612	3092	134
BXRC-35E1000-D-7x-SE	80	175	24.9	4.4	753	685	173
		233	25.4	5.9	988	888	167
		350	26.0	9.1	1411	1269	155
		525	27.4	14.4	2076	1791	144
		700	28.4	19.9	2660	2240	134
BXRC-35G1000-B-7x-SE	90	135	33.1	4.5	646	580	145
		180	33.6	6.1	847	760	140
		270	34.8	9.4	1212	1091	129
		405	36.2	14.7	1778	1582	121
		540	37.5	20.3	2278	2016	112
BXRC-35G1000-C-7x-SE	90	180	33.1	6.0	859	767	144
		240	33.6	8.1	1126	1000	139
		360	34.8	12.5	1616	1455	129
		540	36.2	19.5	2353	2044	120
		720	37.5	27.0	3006	2573	111
BXRC-35G1000-D-7x-SE	90	175	24.9	4.4	627	570	144
		233	25.4	5.9	822	739	139
		350	26.0	9.1	1174	1057	129
		525	27.4	14.4	1728	1490	120
		700	28.4	19.9	2214	1864	111
BXRC-35A1001-B-73-SE	93	135	33.1	4.5	611	549	137
		180	33.6	6.1	801	718	132
		270	34.8	9.4	1146	1032	122
		405	36.2	14.7	1682	1496	115
		540	37.5	20.3	2154	1907	106
BXRC-35A1001-C-73-SE	93	180	33.1	6.0	813	725	136
		240	33.6	8.1	1065	946	132
		360	34.8	12.5	1528	1376	122
		540	36.2	19.5	2226	1933	114
		720	37.5	27.0	2843	2434	105
BXRC-35A1001-D-73-SE	93	175	24.9	4.4	593	539	136
		233	25.4	5.9	778	699	131
		350	26.0	9.1	1110	999	122
		525	27.4	14.4	1634	1409	114
		700	28.4	19.9	2094	1763	105
BXRC-40C1001-B-7x-SE	70	135	33.1	4.5	841	756	188
		180	33.6	6.1	1103	989	182
		270	34.8	9.4	1579	1421	168
		405	36.2	14.7	2316	2060	158
		540	37.5	20.3	2967	2626	146

Notes for Table 4:

1. Alternate drive currents are provided for reference only and are not a guarantee of performance.
2. Bridgelux maintains a ± 7% tolerance on flux measurements.
3. Typical stabilized DC performance values are provided as reference only and are not a guarantee of performance.

Performance at Commonly Used Drive Currents

Table 4: Product Performance at Commonly Used Drive Currents (Continued)

Part Number	CRI	Drive Current ¹ (mA)	Typical V_f $T_c = 25^\circ\text{C}$ (V)	Typical Power $T_c = 25^\circ\text{C}$ (W)	Typical Flux ² $T_c = 25^\circ\text{C}$ (lm)	Typical DC Flux ³ $T_c = 85^\circ\text{C}$ (lm)	Typical Efficacy $T_c = 25^\circ\text{C}$ (lm/W)
BXRC-40E1000-C-7X-SE	70	180	33.1	6.0	1119	999	188
		240	33.6	8.1	1466	1302	182
		360	34.8	12.5	2105	1894	168
		540	36.2	19.5	3065	2662	157
BXRC-40E1000-D-7X-SE	70	720	37.5	27.0	3915	3351	145
		175	24.9	4.4	816	742	187
		233	25.4	5.9	1071	963	181
		350	26.0	9.1	1529	1376	168
BXRC-40G1000-B-7X-SE	80	525	27.4	14.4	2250	1941	157
		700	28.4	19.9	2883	2428	145
		135	33.1	4.5	781	702	175
		180	33.6	6.1	1024	919	169
BXRC-40G1000-C-7X-SE	80	270	34.8	9.4	1466	1319	156
		405	36.2	14.7	2150	1913	147
		540	37.5	20.3	2755	2438	136
		180	33.1	6.0	1039	927	174
BXRC-40G1000-D-7X-SE	80	240	33.6	8.1	1361	1209	169
		350	26.0	9.1	1420	1278	156
		525	27.4	14.4	2090	1802	145
		700	28.4	19.9	2677	2254	135
BXRC-40G1000-B-7X-SE	90	135	33.1	4.5	671	603	150
		180	33.6	6.1	880	789	145
		270	34.8	9.4	1259	1133	134
		405	36.2	14.7	1847	1643	126
BXRC-40G1000-C-7X-SE	90	540	37.5	20.3	2366	2094	117
		180	33.1	6.0	893	796	150
		240	33.6	8.1	1169	1039	145
		360	34.8	12.5	1679	1511	134
BXRC-40G1000-D-7X-SE	90	540	36.2	19.5	2444	2124	125
		720	37.5	27.0	3123	2673	116
		175	24.9	4.4	651	592	149
		233	25.4	5.9	854	768	144
BXRC-40H1000-B-7X-SE	97	350	26.0	9.1	1219	1097	134
		525	27.4	14.4	1795	1548	125
		700	28.4	19.9	2300	1936	116
		135	33.1	4.5	576	517	129
BXRC-40H1000-B-7X-SE	97	180	33.6	6.1	755	677	125
		270	34.8	9.4	1081	972	115
		405	36.2	14.7	1585	1410	108
		540	37.5	20.3	2031	1797	100

Notes for Table 4:

1. Alternate drive currents are provided for reference only and are not a guarantee of performance.
2. Bridgelux maintains a $\pm 7\%$ tolerance on flux measurements.
3. Typical stabilized DC performance values are provided as reference only and are not a guarantee of performance.

Performance at Commonly Used Drive Currents

Table 4: Product Performance at Commonly Used Drive Currents (Continued)

Part Number	CRI	Drive Current ¹ (mA)	Typical V_f $T_c = 25^\circ\text{C}$ (V)	Typical Power $T_c = 25^\circ\text{C}$ (W)	Typical Flux ² $T_c = 25^\circ\text{C}$ (lm)	Typical DC Flux ³ $T_c = 85^\circ\text{C}$ (lm)	Typical Efficacy $T_c = 25^\circ\text{C}$ (lm/W)
BXRC-40H1000-C-7x-SE	97	180	33.1	6.0	766	684	129
		240	33.6	8.1	1004	891	124
		360	34.8	12.5	1441	1297	115
		540	36.2	19.5	2098	1822	107
BXRC-40H1000-D-7x-SE	97	720	37.5	27.0	2680	2294	99
		175	24.9	4.4	559	508	128
		233	25.4	5.9	733	659	124
		350	26.0	9.1	1047	942	115
BXRC-40H1000-D-7x-SE	97	525	27.4	14.4	1540	1329	107
		700	28.4	19.9	1973	1662	99
		135	33.1	4.5	646	580	145
		180	33.6	6.1	847	760	140
BXRC-40A1001-B-73-SE	93	270	34.8	9.4	1212	1091	129
		405	36.2	14.7	1778	1582	121
		540	37.5	20.3	2278	2016	112
		180	33.1	6.0	859	767	144
BXRC-40A1001-C-73-SE	93	240	33.6	8.1	1126	1000	139
		360	34.8	12.5	1616	1455	129
		540	36.2	19.5	2353	2044	120
		720	37.5	27.0	3006	2573	111
BXRC-40A1001-D-73-SE	93	175	24.9	4.4	627	570	144
		233	25.4	5.9	822	739	139
		350	26.0	9.1	1174	1057	129
		525	27.4	14.4	1728	1490	120
BXRC-40A1001-D-73-SE	93	700	28.4	19.9	2214	1864	111
		135	33.1	4.5	856	769	192
		180	33.6	6.1	1123	1007	185
		270	34.8	9.4	1607	1446	171
BXRC-50C1001-B-7x-SE	70	405	36.2	14.7	2357	2097	161
		540	37.5	20.3	3020	2673	149
		180	33.1	6.0	1139	1016	191
		240	33.6	8.1	1492	1326	185
BXRC-50C1001-C-7x-SE	70	360	34.8	12.5	2142	1928	171
		540	36.2	19.5	3119	2710	160
		720	37.5	27.0	3985	3411	148
		175	24.9	4.4	831	755	190
BXRC-50C1001-D-7x-SE	70	233	25.4	5.9	1090	980	184
		350	26.0	9.1	1556	1400	171
		525	27.4	14.4	2290	1975	159
		700	28.4	19.9	2934	2471	148
BXRC-50E1001-B-7x-SE	80	135	33.1	4.5	806	724	181
		180	33.6	6.1	1057	948	175
		270	34.8	9.4	1513	1361	161
		405	36.2	14.7	2219	1974	151
BXRC-50E1001-B-7x-SE	80	540	37.5	20.3	2843	2516	140

Notes for Table 4:

1. Alternate drive currents are provided for reference only and are not a guarantee of performance.
2. Bridgelux maintains a $\pm 7\%$ tolerance on flux measurements.
3. Typical stabilized DC performance values are provided as reference only and are not a guarantee of performance.

Performance at Commonly Used Drive Currents

Table 4: Product Performance at Commonly Used Drive Currents (Continued)

Part Number	CRI	Drive Current ¹ (mA)	Typical V_f $T_c = 25^\circ\text{C}$ (V)	Typical Power $T_c = 25^\circ\text{C}$ (W)	Typical Flux ² $T_c = 25^\circ\text{C}$ (lm)	Typical DC Flux ³ $T_c = 85^\circ\text{C}$ (lm)	Typical Efficacy $T_c = 25^\circ\text{C}$ (lm/W)
BXRC-50E1001-C-7x-SE	80	180	33.1	6.0	1072	957	180
		240	33.6	8.1	1405	1248	174
		360	34.8	12.5	2017	1815	161
		540	36.2	19.5	2937	2551	150
BXRC-50E1001-D-7x-SE	80	720	37.5	27.0	3752	3212	139
		175	24.9	4.4	782	711	179
		233	25.4	5.9	1026	923	173
		350	26.0	9.1	1465	1319	161
BXRC-50G1001-B-7x-SE	90	525	27.4	14.4	2157	1860	150
		700	28.4	19.9	2763	2327	139
		135	33.1	4.5	681	612	153
		180	33.6	6.1	893	801	147
BXRC-50G1001-C-7x-SE	90	270	34.8	9.4	1278	1150	136
		405	36.2	14.7	1875	1668	128
		540	37.5	20.3	2402	2126	118
		180	33.1	6.0	906	808	152
BXRC-50G1001-D-7x-SE	90	240	33.6	8.1	1187	1054	147
		360	34.8	12.5	1704	1533	136
		540	36.2	19.5	2481	2155	127
		720	37.5	27.0	3169	2713	117
BXRC-50G1001-B-7x-SE	90	175	24.9	4.4	661	601	151
		233	25.4	5.9	867	779	146
		350	26.0	9.1	1238	1114	136
		525	27.4	14.4	1822	1571	127
BXRC-57C1001-B-7x-SE	70	700	28.4	19.9	2334	1965	117
		135	33.1	4.5	826	742	185
		180	33.6	6.1	1083	972	179
		270	34.8	9.4	1550	1395	165
BXRC-57C1001-C-7x-SE	70	405	36.2	14.7	2274	2023	155
		540	37.5	20.3	2914	2579	144
		180	33.1	6.0	1099	981	184
		240	33.6	8.1	1440	1279	178
BXRC-57C1001-D-7x-SE	70	360	34.8	12.5	2067	1860	165
		540	36.2	19.5	3010	2615	154
		720	37.5	27.0	3845	3291	142
		175	24.9	4.4	802	729	184
BXRC-57C1001-B-7x-SE	80	233	25.4	5.9	1052	946	178
		350	26.0	9.1	1502	1351	165
		525	27.4	14.4	2210	1906	154
		700	28.4	19.9	2832	2384	142
BXRC-57E1001-B-7x-SE	80	135	33.1	4.5	796	715	178
		180	33.6	6.1	1044	936	172
		270	34.8	9.4	1494	1345	159
		405	36.2	14.7	2192	1950	149
BXRC-57E1001-C-7x-SE	80	540	37.5	20.3	2808	2485	138

Notes for Table 4:

1. Alternate drive currents are provided for reference only and are not a guarantee of performance.
2. Bridgelux maintains a $\pm 7\%$ tolerance on flux measurements.
3. Typical stabilized DC performance values are provided as reference only and are not a guarantee of performance.

Performance at Commonly Used Drive Currents

Table 4: Product Performance at Commonly Used Drive Currents (Continued)

Part Number	CRI	Drive Current ¹ (mA)	Typical V_f $T_c = 25^\circ\text{C}$ (V)	Typical Power $T_c = 25^\circ\text{C}$ (W)	Typical Flux ² $T_c = 25^\circ\text{C}$ (lm)	Typical DC Flux ³ $T_c = 85^\circ\text{C}$ (lm)	Typical Efficacy $T_c = 25^\circ\text{C}$ (lm/W)
BXRC-57E1001-C-7x-SE	80	180	33.1	6.0	1059	945	178
		240	33.6	8.1	1387	1233	172
		360	34.8	12.5	1992	1793	159
		540	36.2	19.5	2901	2520	148
BXRC-57E1001-D-7x-SE	80	720	37.5	27.0	3705	3172	137
		175	24.9	4.4	773	702	177
		233	25.4	5.9	1014	911	171
		350	26.0	9.1	1447	1302	159
BXRC-65C1001-B-7x-SE	70	525	27.4	14.4	2130	1837	148
		700	28.4	19.9	2729	2298	137
		135	33.1	4.5	841	756	188
		180	33.6	6.1	1103	989	182
BXRC-65C1001-C-7x-SE	70	270	34.8	9.4	1579	1421	168
		405	36.2	14.7	2316	2060	158
		540	37.5	20.3	2967	2626	146
		180	33.1	6.0	1119	999	188
BXRC-65C1001-D-7x-SE	70	240	33.6	8.1	1466	1302	182
		350	26.0	9.1	1529	1376	168
		525	27.4	14.4	2250	1941	157
		700	28.4	19.9	2883	2428	145
BXRC-65E1001-B-7x-SE	80	175	24.9	4.4	816	742	187
		233	25.4	5.9	1071	963	181
		270	34.8	9.4	1522	1370	162
		405	36.2	14.7	2233	1987	152
BXRC-65E1001-C-7x-SE	80	540	37.5	20.3	2861	2532	141
		180	33.1	6.0	1079	963	181
		240	33.6	8.1	1414	1256	175
		360	34.8	12.5	2030	1827	162
BXRC-65E1001-D-7x-SE	80	540	36.2	19.5	2955	2567	151
		720	37.5	27.0	3775	3231	140
		175	24.9	4.4	787	716	180
		233	25.4	5.9	1033	928	174
BXRC-65E1001-D-7x-SE	80	350	26.0	9.1	1474	1327	162
		525	27.4	14.4	2170	1871	151
		700	28.4	19.9	2780	2341	140
		175	24.9	4.4	787	716	180

Notes for Table 4:

1. Alternate drive currents are provided for reference only and are not a guarantee of performance.
2. Bridgelux maintains a $\pm 7\%$ tolerance on flux measurements.
3. Typical stabilized DC performance values are provided as reference only and are not a guarantee of performance.

Electrical Characteristics

Table 5: Electrical Characteristics

Part Number	Drive Current (mA)	Forward Voltage Pulsed, $T_c = 25^\circ\text{C}$ (V) ^{1, 2, 3, 8}			Typical Coefficient of Forward Voltage ⁴ $\Delta V_f / \Delta T_c$ (mV/ $^\circ\text{C}$)	Typical Thermal Resistance Junction to Case ^{5,6} R_{j-c} ($^\circ\text{C}/\text{W}$)	Driver Selection Voltages ⁷ (V)	
		Minimum	Typical	Maximum			V_f Min. Hot $T_c = 105^\circ\text{C}$ (V)	V_f Max. Cold $T_c = -40^\circ\text{C}$ (V)
BXRC-xxx100x-B-7x-SE	270	32.2	34.8	37.4	-16.1	0.49	30.9	38.5
	540	34.7	37.5	40.3	-16.1	0.56	33.4	41.4
BXRC-xxx100x-C-7x-SE	360	32.2	34.8	37.4	-16.1	0.37	30.9	38.5
	720	34.7	37.5	40.3	-16.1	0.45	33.4	41.4
BXRC-xxx100x-D-7x-SE	350	24.1	26.0	28.0	-11.8	0.49	23.1	28.7
	700	26.3	28.4	30.5	-11.8	0.57	25.3	31.3

Notes for Table 5:

- Parts are tested in pulsed conditions, $T_c = 25^\circ\text{C}$. Pulse width is 10ms.
- Voltage minimum and maximum are provided for reference only and are not a guarantee of performance.
- Bridgelux maintains a tester tolerance of $\pm 0.10\text{V}$ on forward voltage measurements.
- Typical coefficient of forward voltage tolerance is $\pm 0.1\text{mV}$ for nominal current.
- Thermal resistance values are based from test data of a 3000K 80 CRI product.
- Thermal resistance value was calculated using total electrical input power; optical power was not subtracted from input power. The thermal interface material used during testing is not included in the thermal resistance value.
- V_f min hot and max cold values are provided as reference only and are not guaranteed by test. These values are provided to aid in driver design and selection over the operating range of the product.
- This product has been designed and manufactured per IEC 62031:2014. This product has passed dielectric withstand voltage testing at 1160 V. The working voltage designated for the insulation is 80V d.c. The maximum allowable voltage across the array must be determined in the end product application.

Eye Safety

Table 6: Eye Safety Risk Group (RG) Classifications

Part Number	Drive Current ⁵ (mA)	CCT ⁵			
		2700K/3000K	4000K ²	5000K ³	6500K ⁴
BXRC-xxx100x-B-7x-SE	270	RG1	RG1	RG1	RG1
	405	RG1	RG1	RG1	RG2
	540	RG1	RG1	RG2	RG2
BXRC-xxx100x-C-7x-SE	360	RG1	RG1	RG1	RG2
	540	RG1	RG1	RG2	RG2
	720	RG1	RG2	RG2	RG2
BXRC-xxx100x-D-7x-SE	350	RG1	RG1	RG1	RG1
	525	RG1	RG1	RG1	RG2
	700	RG1	RG1	RG2	RG2

Notes for Table 6:

1. Eye safety classification for the use of Bridgelux Vero SE Series LED arrays is in accordance with specification IEC/TR 62778: Application of IEC 62471 for the assessment of blue light hazard to light sources and luminaires.
2. For products classified as RG2 at 4000K, $E_{thr} = 1847.5$ lx.
3. For products classified as RG2 at 5000K $E_{thr} = 1315.8$ lx.
4. For products classified as RG2 at 6500K, $E_{thr} = 1124.5$ lx.
5. Please contact your Bridgelux sales representative for E_{thr} values at specific drive currents and CCTs not listed.

Absolute Maximum Ratings

Table 7: Maximum Ratings

Parameter	Maximum Rating		
LED Junction Temperature (T_j)	150°C		
Storage Temperature	-40°C to +105°C		
Operating Case Temperature ¹ (T_c)	105°C		
	BXRC-xxx100x-B-7x-SE	BXRC-xxx100x-C-7x-SE	BXRC-xxx100x-D-7x-SE
Maximum Drive Current ³	540mA	720mA	700mA
Maximum Peak Pulsed Drive Current ⁴	770mA	1030mA	1000mA
Maximum Reverse Voltage ⁵	-60V	-60V	-45V

Notes for Table 7:

1. For IEC 62717 requirement, please consult your Bridgelux sales representative.
2. Refer to Bridgelux Application Note AN120: Assembly Considerations for Bridgelux Vero SE LED Arrays.
3. Arrays may be driven at higher currents however lumen maintenance may be reduced.
4. Bridgelux recommends a maximum duty cycle of 10% and pulse width of 20 ms when operating LED Arrays at maximum peak pulsed current specified. Maximum peak pulsed currents indicate values where LED Arrays can be driven without catastrophic failures.
5. Light emitting diodes are not designed to be driven in reverse voltage and will not produce light under this condition. Maximum rating provided for reference only.

Performance Curves

Figure 1: Vero SE 10B Drive Current vs. Voltage

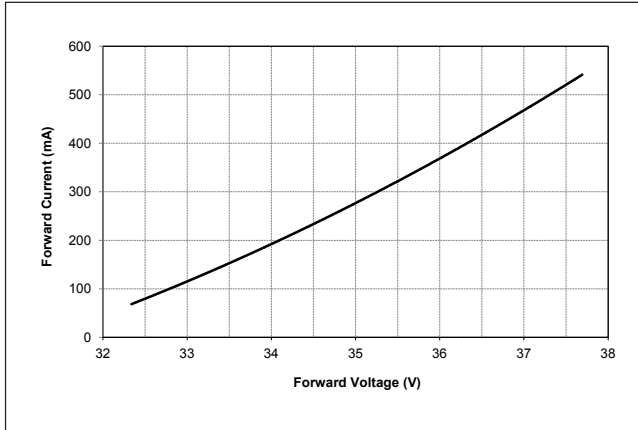

Figure 2: Vero SE 10C Drive Current vs. Voltage

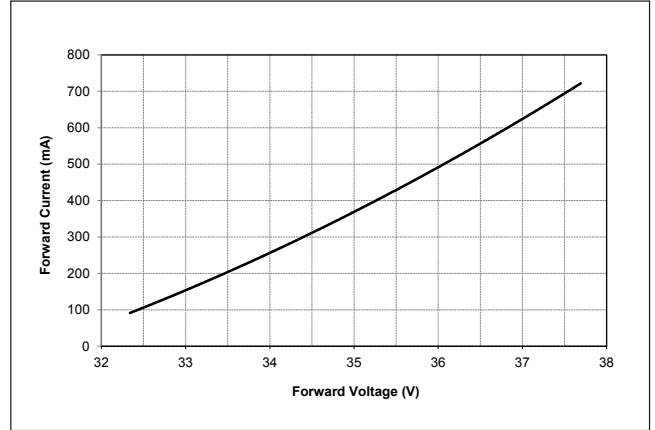

Figure 3: Vero SE 10D Drive Current vs. Voltage

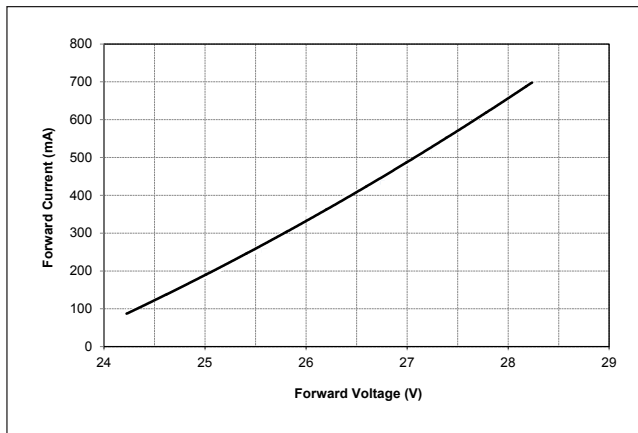

Figure 4: Vero 10B SE Typical Relative Flux vs. Current

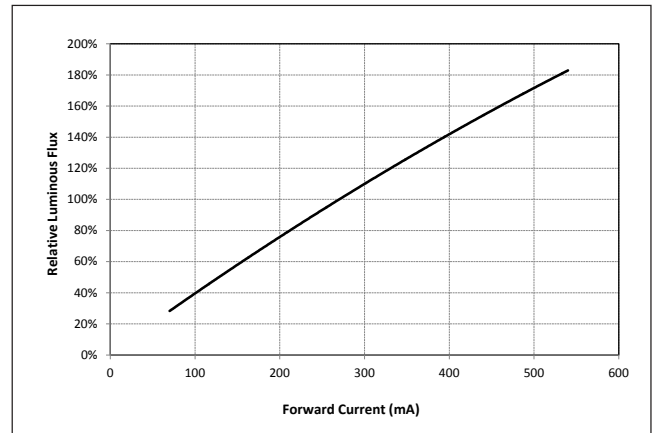

Figure 5: Vero 10C SE Typical Relative Flux vs. Current

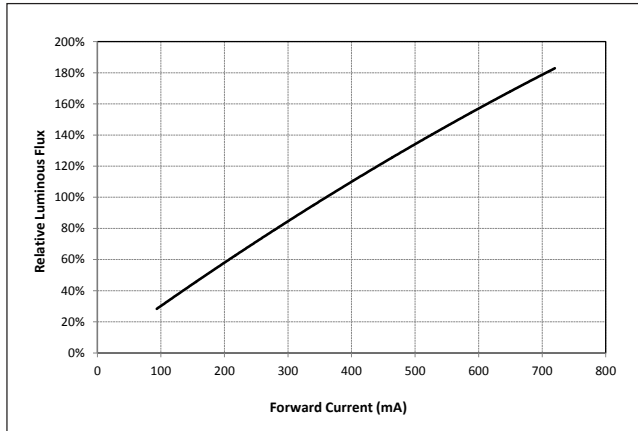
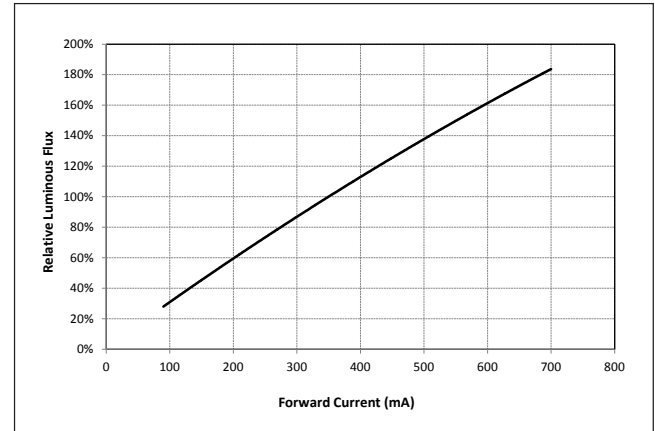

Figure 6 Vero 10D SE Typical Relative Flux vs. Current



Notes for Figure 1-6:

1. Bridgelux does not recommend driving high power LEDs at low currents. Doing so may produce unpredictable results. Pulse width modulation (PWM) is recommended for dimming effects.
2. Products tested under pulsed condition (10ms pulse width) at nominal test current where T_j (junction temperature) = T_c (case temperature) = 25°C.

Performance Curves

Figure 7: Typical DC Flux vs. Case Temperature

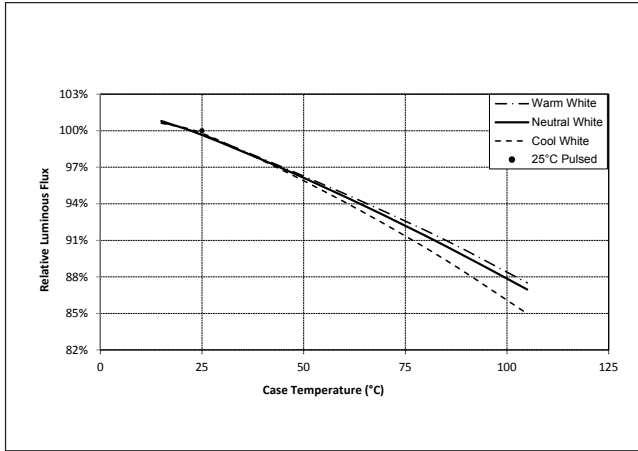

Figure 8: Typical DC ccy Shift vs. Case Temperature

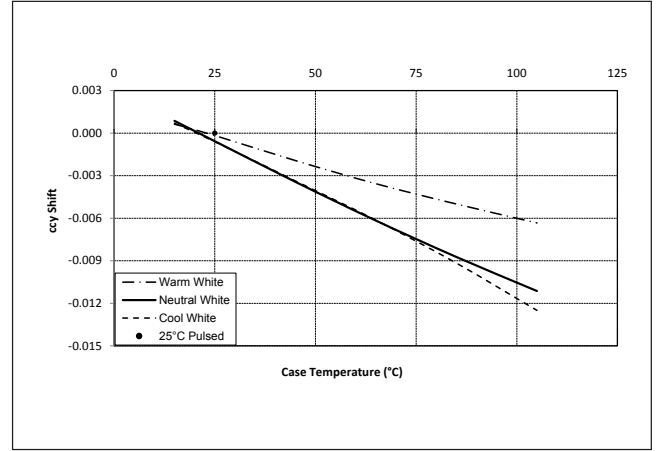

Figure 9: Typical DC ccx Shift vs. Case Temperature

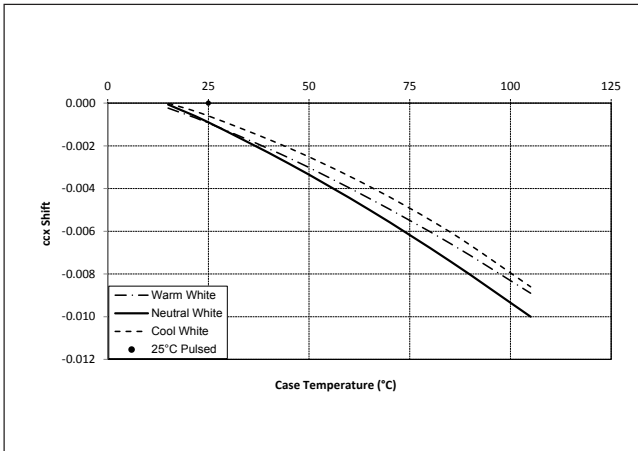
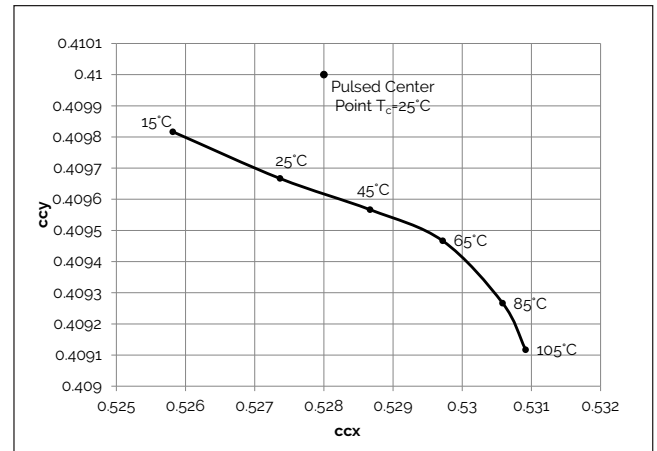

Figure 10: 2000K, 65 CRI Color Shift vs. Case Temperature



Notes for Figures 7 - 9:

1. Characteristics shown for warm white based on 3000K and 80 CRI.
2. Characteristics shown for neutral white based on 4000K and 80 CRI.
3. Characteristics shown for cool white based on 5000K and 70 CRI.
4. For other color SKUs, the shift in color will vary. Please contact your Bridgelux Sales Representative for more information.

Performance Curves

Figure 11: 2700K, 97 CRI Color Shift vs. Case Temperature¹

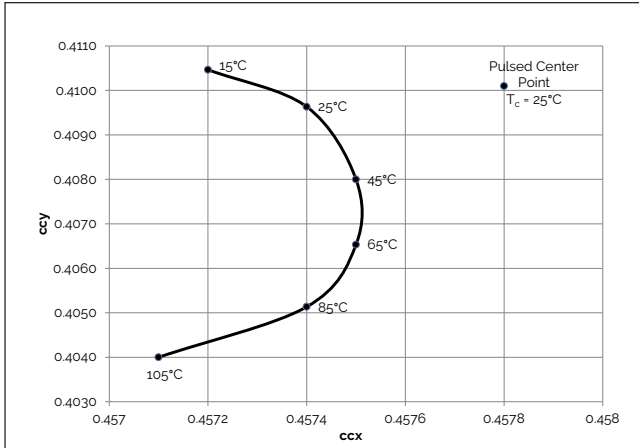

Figure 12: 3000K, 97 CRI Color Shift vs. Case Temperature¹

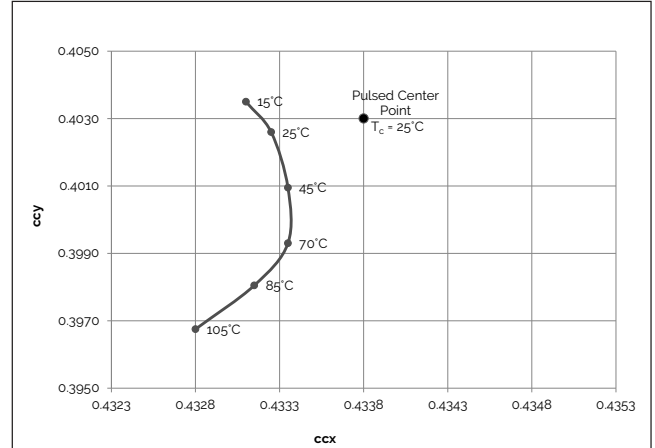

Figure 13: 3000K, 90 CRI Color Shift vs. Case Temperature^{1,3}

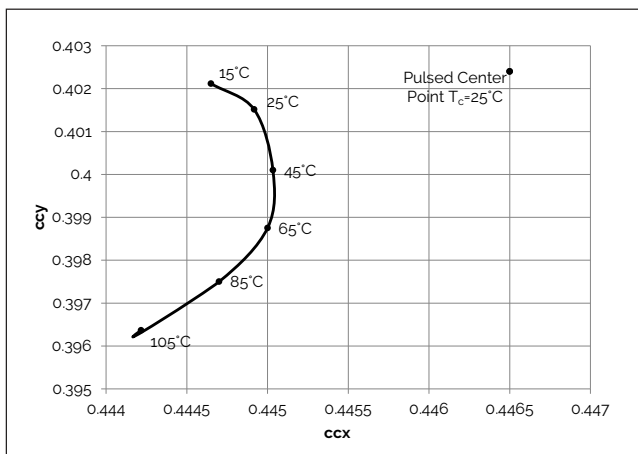

Figure 14: 3000K Class A Color Shift vs. Case Temperature¹

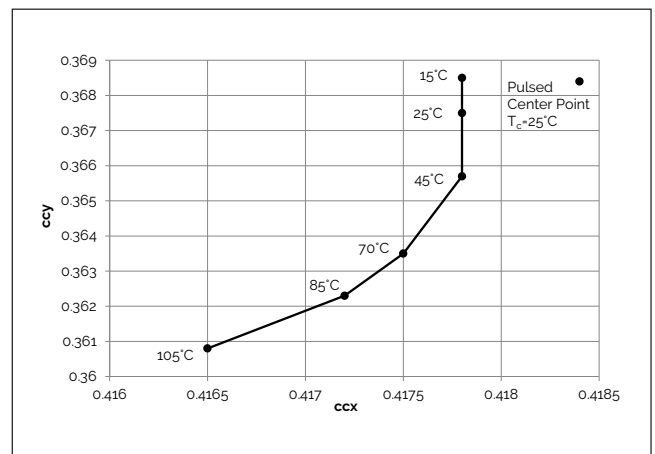

Figure 15: 3500K Class A Color Shift vs. Case Temperature¹

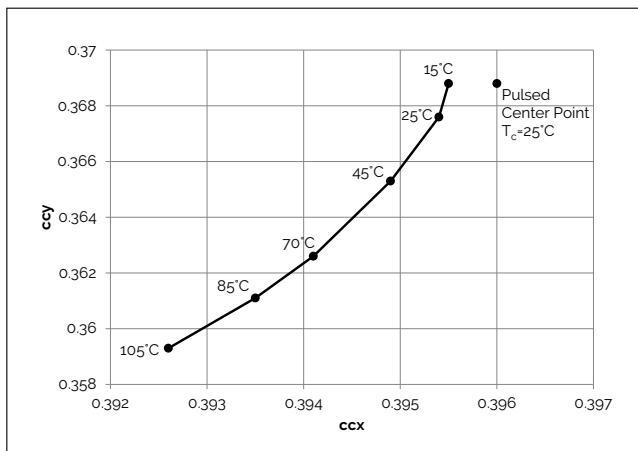
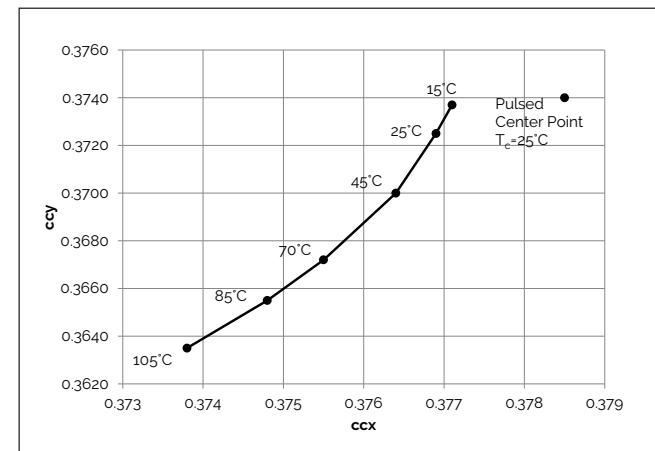

Figure 16: 4000K Class A Color Shift vs. Case Temperature¹



Note for Figures 10-16:

1. Measurements made under DC test conditions at the nominal drive current.
2. Typical color shift is shown with a tolerance of ± 0.002 .
3. Characteristics shown for Decor Series Showcase products, BXRC-30G100C-x-73-SE

Typical Radiation Pattern

Figure 17: Typical Spatial Radiation Pattern

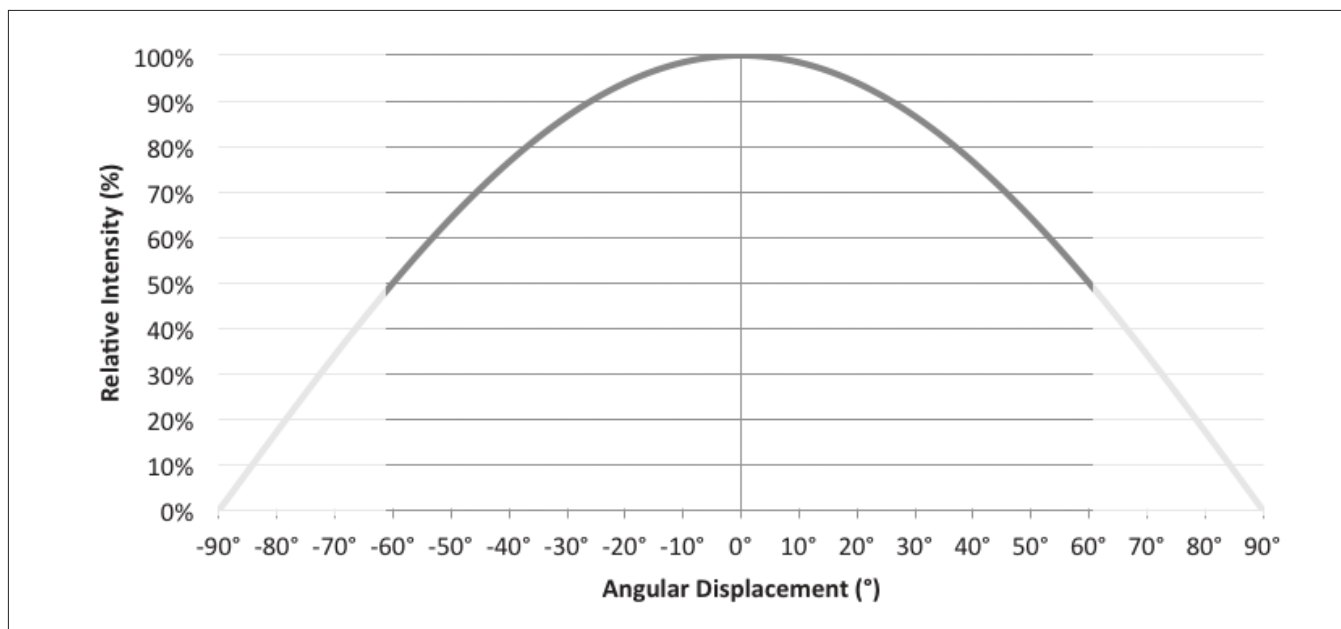

Note for Figure 17:

1. Typical viewing angle is 120°.
2. The viewing angle is defined as the off axis angle from the centerline where intensity is ½ of the peak value.

Figure 18: Typical Polar Radiation Pattern

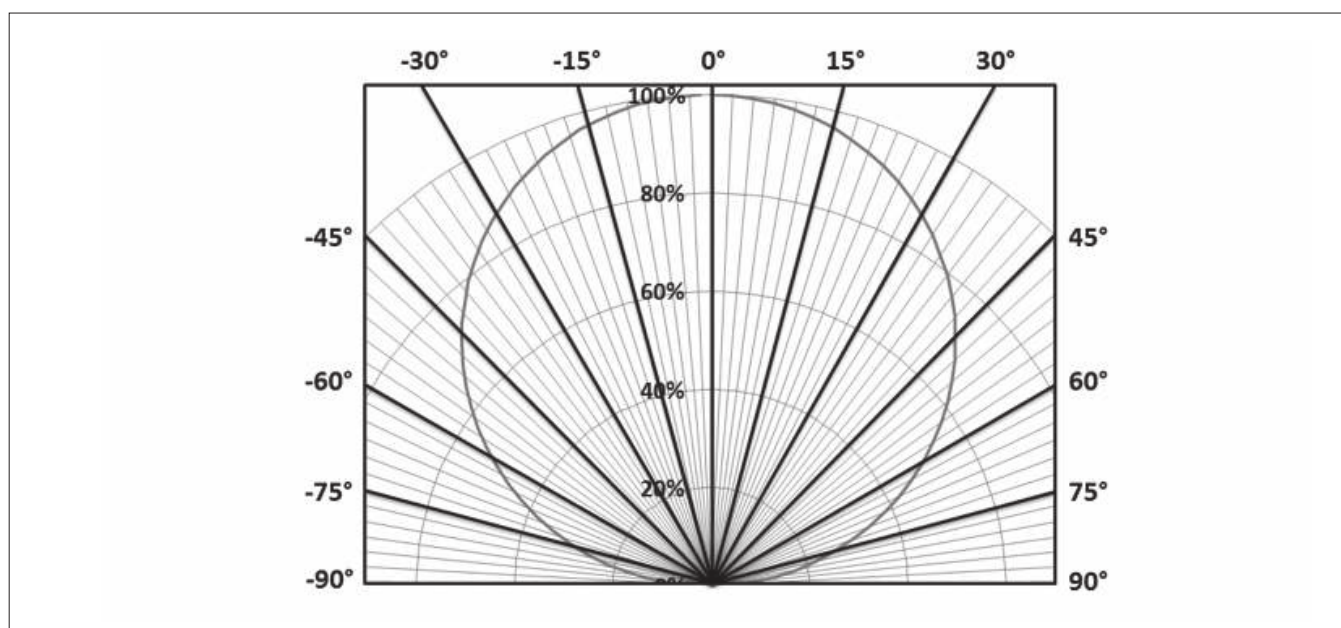

Typical Color Spectrum

Figure 19: Typical Color Spectrum

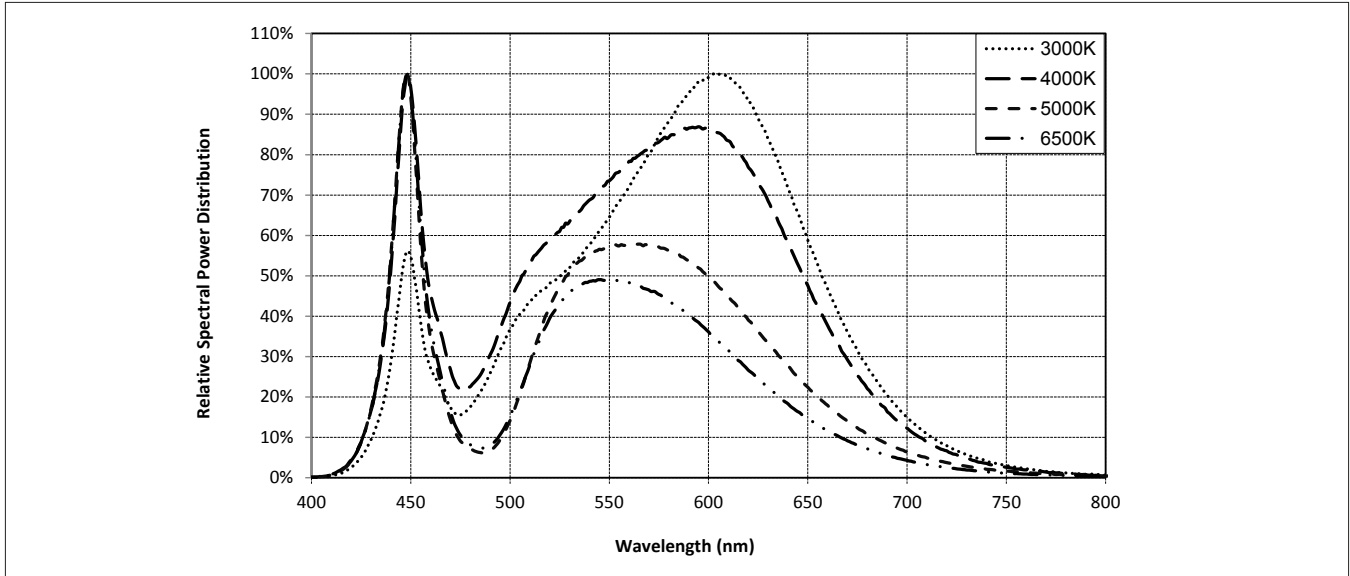

Note for Figure 19:

1. Color spectra measured at nominal current for $T_j = T_c = 25^\circ\text{C}$.
2. Color spectra shown is 3000K and 80 CRI.
3. Color spectra shown is 4000K and 80 CRI.
4. Color spectra shown is 5000K and 70 CRI.
4. Color spectra shown is 6500K and 70 CRI.

Figure 20: Typical Color Spectrum for Vero SE 10 with Décor Series

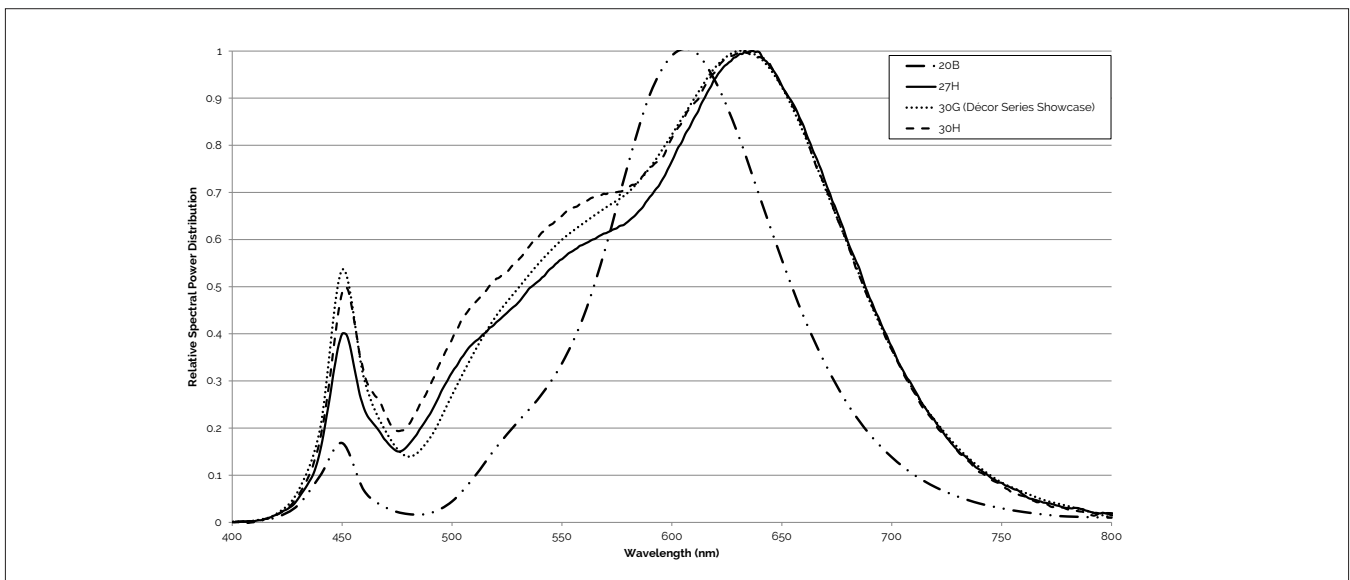

Note for Figure 20:

1. Color spectra measured at nominal current for $T_j = T_c = 25^\circ\text{C}$.

Mechanical Dimensions

Figure 21: Drawing for Vero SE 10 LED Array

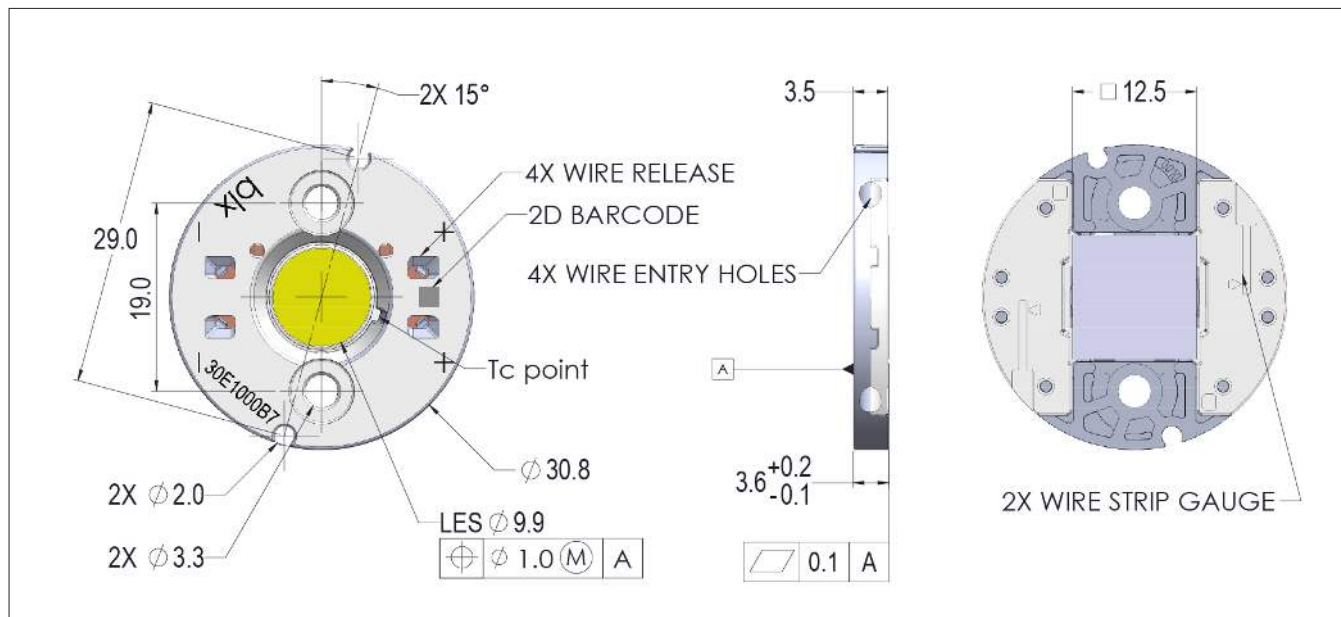

Notes for Figure 21:

1. Drawings are not to scale.
2. Dimensions are in mm.
3. Unless otherwise specified, tolerances are ± 0.10 mm.
4. Mounting holes (2X) are for M3 screws.
5. Bridgelux recommends two tapped holes for mounting screws with 19.0 ± 0.10 mm center-to-center spacing.
6. Screws with flat shoulders (pan, dome, button, round, truss, mushroom) provide optimal torque control. Do NOT use flat, countersink, or raised head screws.
7. The optical center of the LED Array is nominally defined by the mechanical center of the array to a tolerance of ± 0.2 mm.
8. Bridgelux maintains a flatness of 0.10mm across the mounting surface of the array.

Color Binning Information

Figure 22: Warm and Neutral White Test Bins in xy Color Space

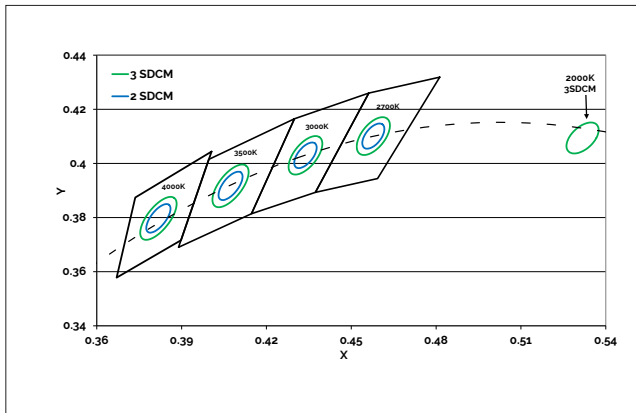

Note: Pulsed Test Conditions, $T_c = 25^\circ\text{C}$

Figure 23: Cool White Test Bins in xy Color Space

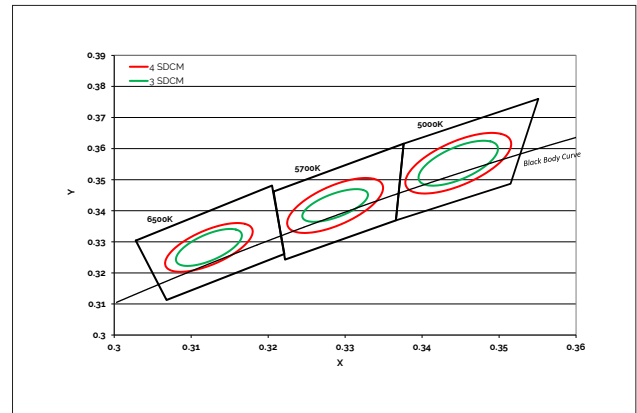

Note: Pulsed Test Conditions, $T_c = 25^\circ\text{C}$

Table 8: Warm and Neutral White xy Bin Coordinates and Associated Typical CCT

Bin Code ¹	2000K	2700K	3000K ²	3500K ¹	4000K ¹
ANSI Bin (for reference only)	-	(2580K - 2870K)	(2870K - 3220K)	(3220K - 3710K)	(3710K - 4260K)
73 (3 SDCM)	-	(2651K - 2794K)	(2968K - 3136K)	(3369K - 3586K)	(3851K - 4130K)
72 (2 SDCM)	-	(2674K - 2769K)	(2995K - 3107K)	(3404K - 3548K)	(3895K - 4081K)
Center Point (x,y)	(0.5280, 0.4100)	(0.4578, 0.4101)	(0.4338, 0.403) (0.4465, 0.4024) ²	(0.4073, 0.3917)	(0.3818, 0.3797)

Note for Table 8:

- Color Binning information excludes Decor Series Class A products. Please contact your Bridgelux Sales Representative for more information.
- Center Point for Decor Series Showcase.

Table 9: Cool White xy Bin Coordinates and Associated Typical CCT (product is hot targeted to $T_c = 85^\circ\text{C}$)

Bin Code	5000K	5700K	6500K
ANSI Bin (for reference only)	(4745K - 5311K)	(5312K - 6022K)	(6022K - 7042K)
74 (4 SDCM)	(4801K - 5282K)	(5481K - 5829K)	(6270K - 6765K)
73 (3 SDCM)	(4835K - 5215K)	(5490K - 5820K)	(6250K - 6745K)
Center Point (x,y)	(0.3447, 0.3553)	(0.3287, 0.3417)	(0.3123, 0.3282)

Packaging and Labeling

Figure 24: Drawing for Vero SE 10 Packaging Tray

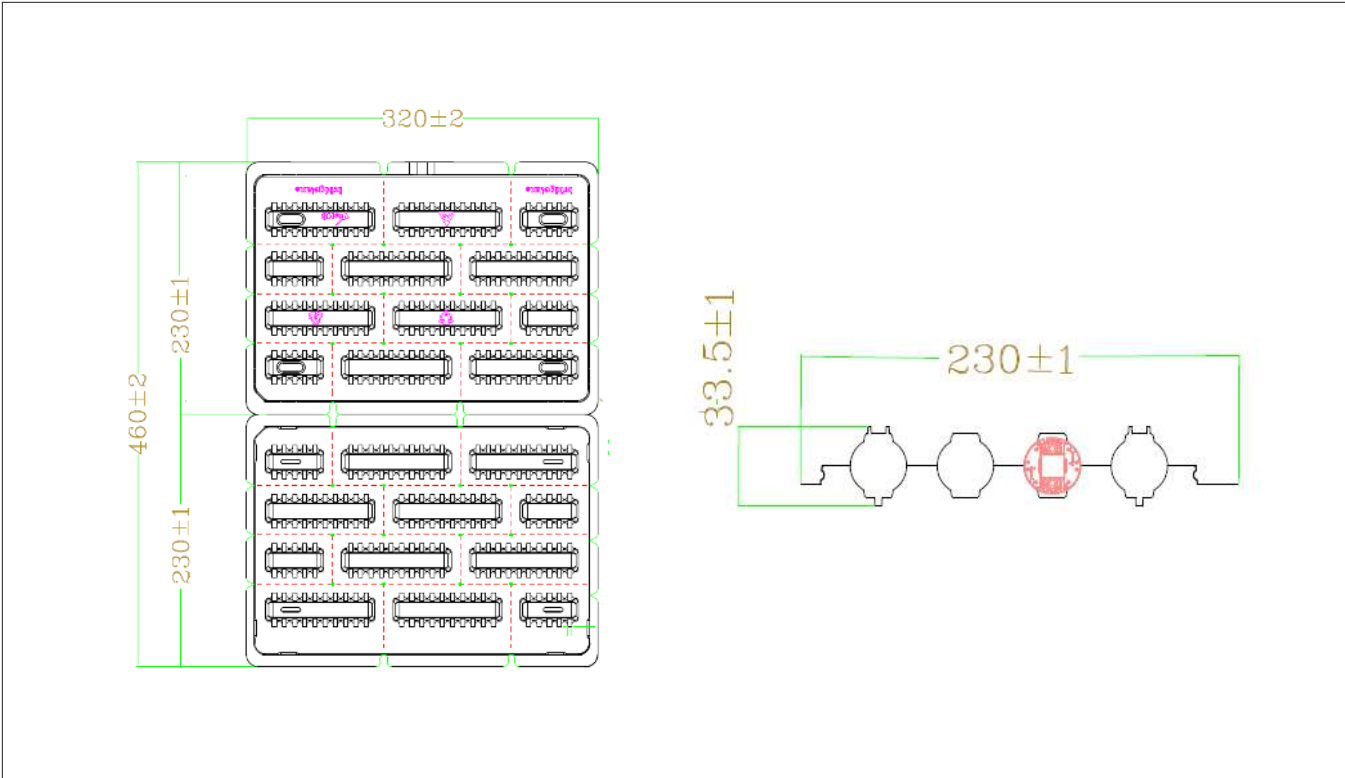

- Notes for Figure 24:
- 1. Dimensions are in millimeters.
 - 2. Drawings are not to scale.

Packaging and Labeling

Figure 25: Vero SE Series Packaging and Labeling

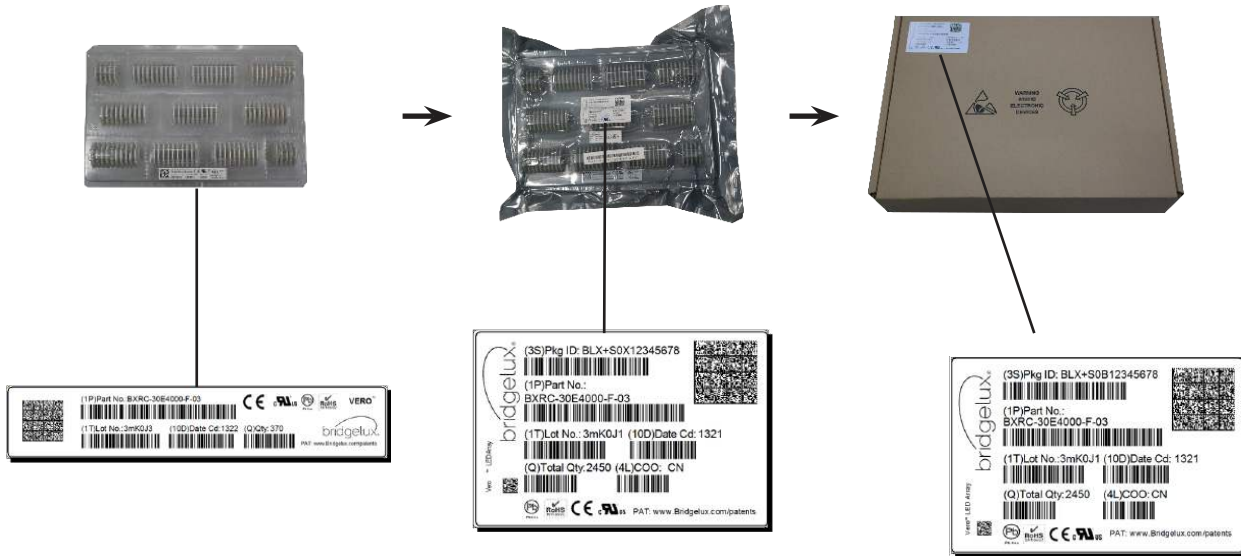

Notes for Figure 25:

1. Each tray holds 200 COBs.
2. Each tray is vacuum sealed in an anti-static bag and placed in its own box.
3. Each tray, bag and box is to be labeled as shown above.

Figure 26: Vero SE Product Labeling

Bridgelux COB arrays have laser markings on the back side of the substrate to help with product identification. In addition to the product identification markings, Bridgelux COB arrays also contain markings for internal Bridgelux manufacturing use only. The image below shows which markings are for customer use and which ones are for Bridgelux internal use only. The Bridgelux internal manufacturing markings are subject to change without notice, however these will not impact the form, function or performance of the COB array.



Customer Use- 2D Barcode
Scannable barcode provides product part number, V_i bin and other Bridgelux internal production information.

Customer Use- Product part number

30E1000C 72 2F

Customer Use- V_i Bin Code included to enable greater luminaire design flexibility. Refer to ANg2 for bin code definitions.

Design Resources

Application Notes

Bridgelux has developed a comprehensive set of application notes and design resources to assist customers in successfully designing with the Vero product family of LED array products. For all available application notes visit www.bridgelux.com.

Optical Source Models

Optical source models and ray set files are available for all Bridgelux products. For a list of available formats, visit www.bridgelux.com.

3D CAD Models

Three dimensional CAD models depicting the product outline of all Bridgelux Vero LED arrays are available in both IGS and STEP formats. Please contact your Bridgelux sales representative for assistance.

LM80

LM80 testing has been completed and the LM80 report is now available. Please contact your Bridgelux sales representative for LM-80 report.

Precautions

CAUTION: CHEMICAL EXPOSURE HAZARD

Exposure to some chemicals commonly used in luminaire manufacturing and assembly can cause damage to the LED array. Please consult Bridgelux Application Note AN121 for additional information.

CAUTION: RISK OF BURN

Do not touch the Vero LED array during operation. Allow the array to cool for a sufficient period of time before handling. The Vero LED array may reach elevated temperatures such that could burn skin when touched.

CAUTION

CONTACT WITH LIGHT EMITTING SURFACE (LES)

Avoid any contact with the LES. Do not touch the LES of the LED array or apply stress to the LES (yellow phosphor resin area). Contact may cause damage to the LED array.

Optics and reflectors must not be mounted in contact with the LES (yellow phosphor resin area). Optical devices may be mounted on the top surface of the plastic housing of the Vero LED array. Use the mechanical features of the LED array housing, edges and/or mounting holes to locate and secure optical devices as needed.

Disclaimers

MINOR PRODUCT CHANGE POLICY

The rigorous qualification testing on products offered by Bridgelux provides performance assurance. Slight cosmetic changes that do not affect form, fit, or function may occur as Bridgelux continues product optimization.

STANDARD TEST CONDITIONS

Unless otherwise stated, array testing is performed at the nominal drive current.

About Bridgelux: Bridging Light and Life™

At Bridgelux, we help companies, industries and people experience the power and possibility of light. Since 2002, we've designed LED solutions that are high performing, energy efficient, cost effective and easy to integrate. Our focus is on light's impact on human behavior, delivering products that create better environments, experiences and returns—both experiential and financial. And our patented technology drives new platforms for commercial and industrial luminaires.

For more information about the company, please visit
bridgelux.com
twitter.com/Bridgelux
facebook.com/Bridgelux
youtube.com/user/Bridgelux
linkedin.com/company/bridgelux-inc-_2
WeChat ID: BridgeluxInChina



46430 Fremont Boulevard
Fremont, CA 94538 U.S.A.
Tel (925) 583-8400
www.bridgelux.com

© 2016-2018 Bridgelux, Inc. All rights reserved 2018. Product specifications are subject to change without notice. Bridgelux, the Bridgelux stylized logo design, Vero, V Series, V Series HD and are registered trademarks, and Decor Series is a trademark of Bridgelux, Inc. All other trademarks are the property of their respective owners.

Bridgelux Vero SE 10 Array Series Product Data Sheet DS120 Rev. K (11/2018)