

## 30A and 50A, 48VDC EMI Filters

### Features

- ◆ High Attenuation
- ◆ Stud Terminal Connection
- ◆ Compact Size



Last time buy - June 1, 2014

Specifications			
Model		MBS4830	MBS4850
Rated Voltage	VDC	48VDC (72VDC Max)	
Rated Current	A	30A, 45A peak surge for 1 min	50A, 75A peak surge for 1 min
Test Voltage (For 1 min.)	V	Terminals to Case: 700VDC (20mA) at 25°C, 70% RH Between terminals 100VDC (20mA) at 25°C, 70% RH	
Isolation Resistance	MΩ	500MΩ minimum at 25°C, 70% RH	
Leakage Current	mA	Not Applicable	
DC Resistance	mΩ	8	4
Temperature Rise	°C	35	30
Operating Temperature	°C	-25° to +85°C (see derating curve)	
Storage Temperature	°C	-40° to +85°	
Operating Humidity	-	30 to 95% RH (non condensing)	
Storage Humidity	-	10 to 95% RH (non condensing)	
Vibration	-	10-55-10Hz, Amplitude 1.5mm (1 minute), X, Y, Z (2 hour each)	
Weight (Typ)	g	310	650
Warranty	-	1 Year	

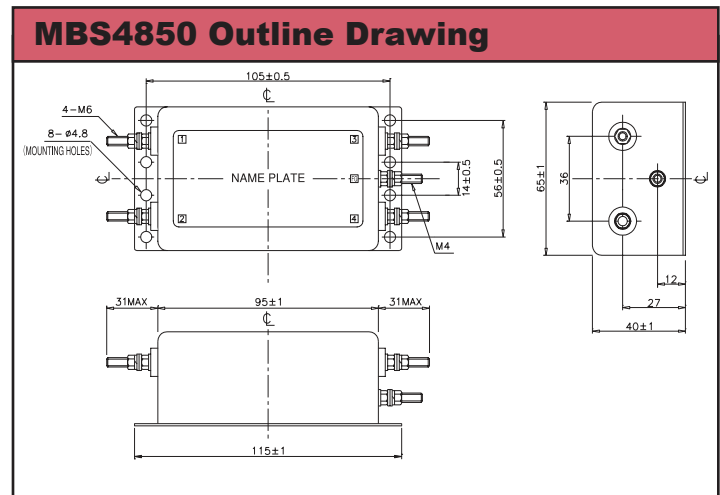
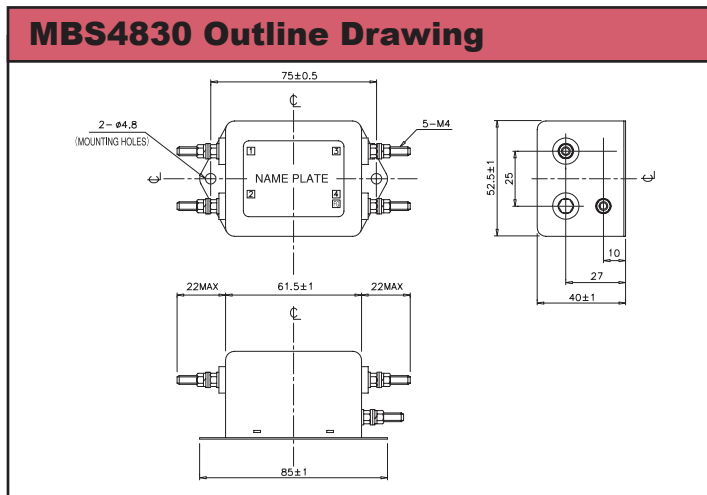

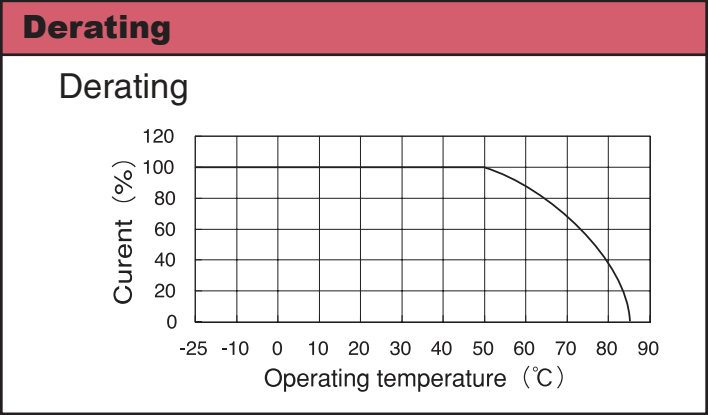
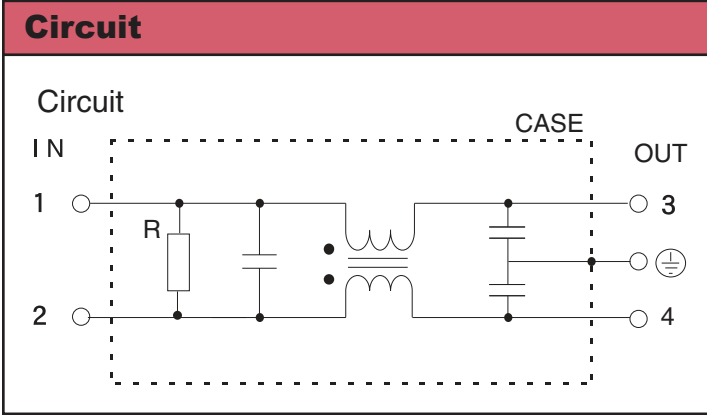

**Typ. Insertion Loss, Symmetrical**

(1) Asymmetrical

**MBS4830**

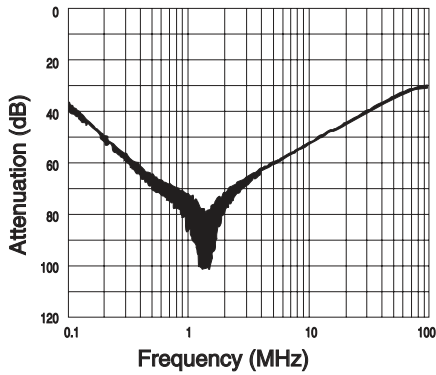

(2) Symmetrical

**MBS4830**

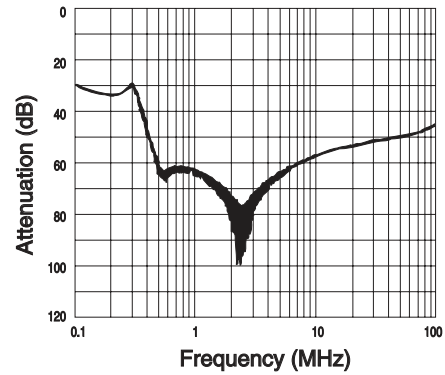

**MBS4850**

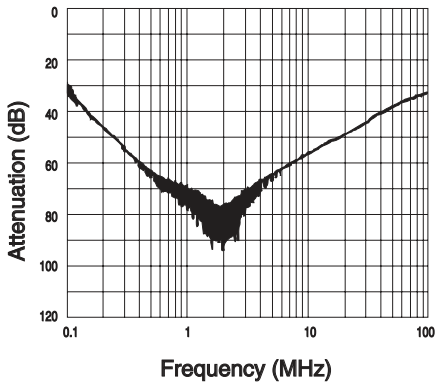

**MBS4850**

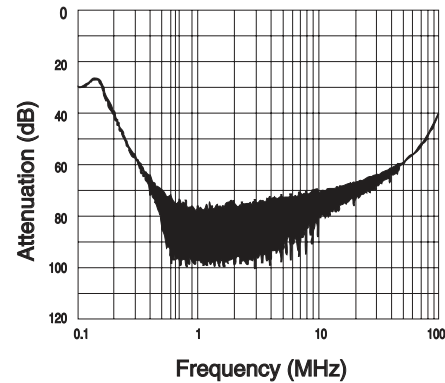

For Additional Information, please visit [us.tdk-lambda.com/lp/products/mbs-series.htm](http://us.tdk-lambda.com/lp/products/mbs-series.htm)



**Last time buy - June 1, 2014**