

ISL9241EVAL1Z

User's Manual: Evaluation Board

Battery and Optical

All information contained in these materials, including products and product specifications, represents information on the product at the time of publication and is subject to change by Renesas Electronics Corp. without notice. Please review the latest information published by Renesas Electronics Corp. through various means, including the Renesas Electronics Corp. website (<http://www.renesas.com>).

ISL9241EVAL1Z

Evaluation Board

The [ISL9241](#) is a configurable buck-boost Narrow Output Voltage DC (NVDC) and Hybrid Power Buck-Boost (HPBB) combo charger that uses the advanced Renesas R3™ Technology to provide high light-load efficiency, fast transient response, and seamless DCM/CCM transitions for a variety of mobile and industrial applications.

In Charge mode, the ISL9241 takes input power from a wide range (4V to 20V) of DC power sources (such as conventional AC/DC charger adapters, USB PD ports, travel adapters) and safely charges battery packs with up to four cells in a series configuration.

The ISL9241 supports On-the-Go (OTG) functionality for 2-cell and 4-cell battery applications. When OTG function is enabled, the ISL9241 operates in Reverse Buck mode to provide 5V at the USB port.

Serial communication through SMBus/I²C allows programming of many critical parameters to deliver a customized solution. These programming parameters include, but are not limited to, adapter current limit, charger current limit, system voltage setting, and trickle charging current limit.

The ISL9241EVAL1Z evaluation board is designed to demonstrate the performance of the ISL9241. From the PROG pin to GND, the resistor can be used to program the default value numbers of the battery in series, the switching frequency, and the adapter current limit charging function. The default value numbers can also be set by SMBus.

Key Features

- Buck-boost NVDC and HPBB charger for 2-, 3-, and 4-cell Li-ion batteries
- Autonomous End of Charge (EOC) option
- System power monitor PSYS output
- PROCHOT# open-drain output
- Allows trickle charging of depleted battery
- Supplemental power (Intel VMIN active protection)
- Ideal diode control in Turbo mode
- Reverse buck, boost, and buck-boost operation from battery
- Two-level adapter current limit available
- Battery Ship mode option
- SMBus and auto-increment I²C compatible

Specifications

- V_{IN} = 3.8V to 24V (no dead zone)
- V_{OUT} = 3.9V to 18.304V
- MAX I_{charge} up to 6A

Ordering Information

Part Number	Description
ISL9241EVAL1Z	ISL9241 buck-boost charger evaluation board

Related Literature

For a full list of related documents, visit our website:

- [ISL9241](#) device page

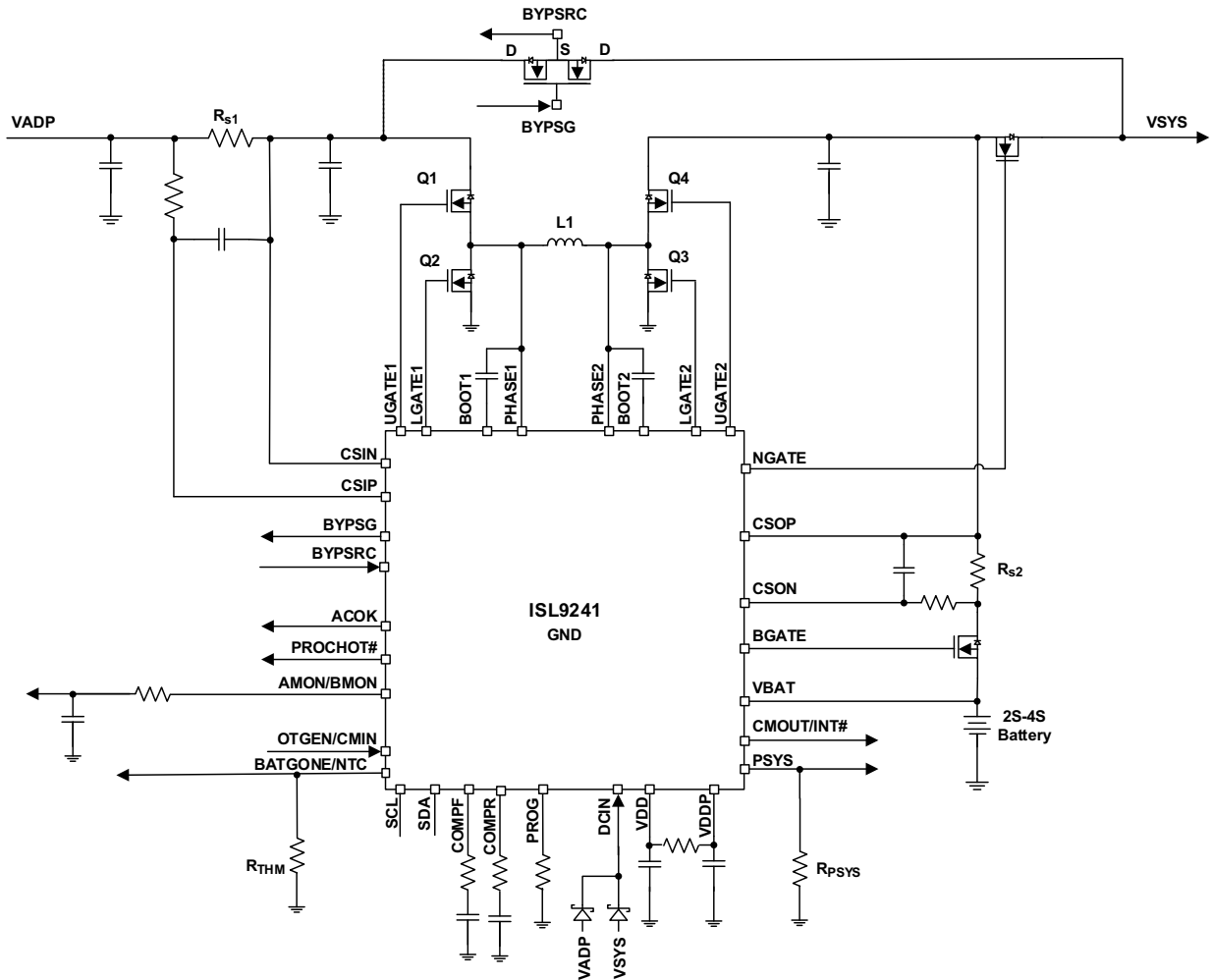

Figure 1. ISL9241EVAL1Z Block Diagram

Recommended Equipment

- 0V to 25V power supply with at least 6A source current capability
- Electronic load capable of sinking current up to 6A
- Battery emulator capable of sinking and sourcing current up to 6A
- Digital Multimeters (DMMs)
- 100MHz quad-trace oscilloscope

Note: You can use a power supply (that can source but cannot sink current) in parallel with an e-load Constant Current (CC) mode to emulate the battery. For example, when charging, set the charging current command lower than the CC mode e-load. If the e-load CC mode current is set at 3A, the charge current command is 2A and the e-load takes 2A from the charger and another 1A from the power supply in parallel with it. When discharging, the power supply acts just like the battery to discharge current. You can also use the e-load Constant Voltage (CV) mode to emulate the battery to take the charging current from the charger and set the e-load CV voltage below the MaxSysV register setting. However, this e-load CV mode cannot source current like a battery.

1. Installing the ISL9241 Software

The ISL9241 Control Software communicates with the ISL9241 controller using the USB to on-board SMBus Graphical User Interface (GUI). The GUI facilitates access to the ISL9241 SMBus registers.

This section describes how to install, start, and use the GUI.

1.1 Required Hardware

- ISL9241EVAL1Z evaluation board
- USB 2.0 A/B cable

1.2 Required Software

The software Installation Wizard package includes all three required components:

- ISL9241 SMBus Control Tool
- National Instruments Runtime VISA Engine
- USB interface module driver

1.3 Installing the GUI

Both the ISL9241 Control Software and the National Instruments Runtime Engine are installed automatically from the installation wizard.

Note: Close all other applications before this installation and reboot the computer when the installation is complete.

1. Extract the zip file to the local drive, not the network drive. The security of the network prohibits the **.inf** file from being copied onto the network.
2. Run **autorun.exe**. The menu in [Figure 2](#) appears.

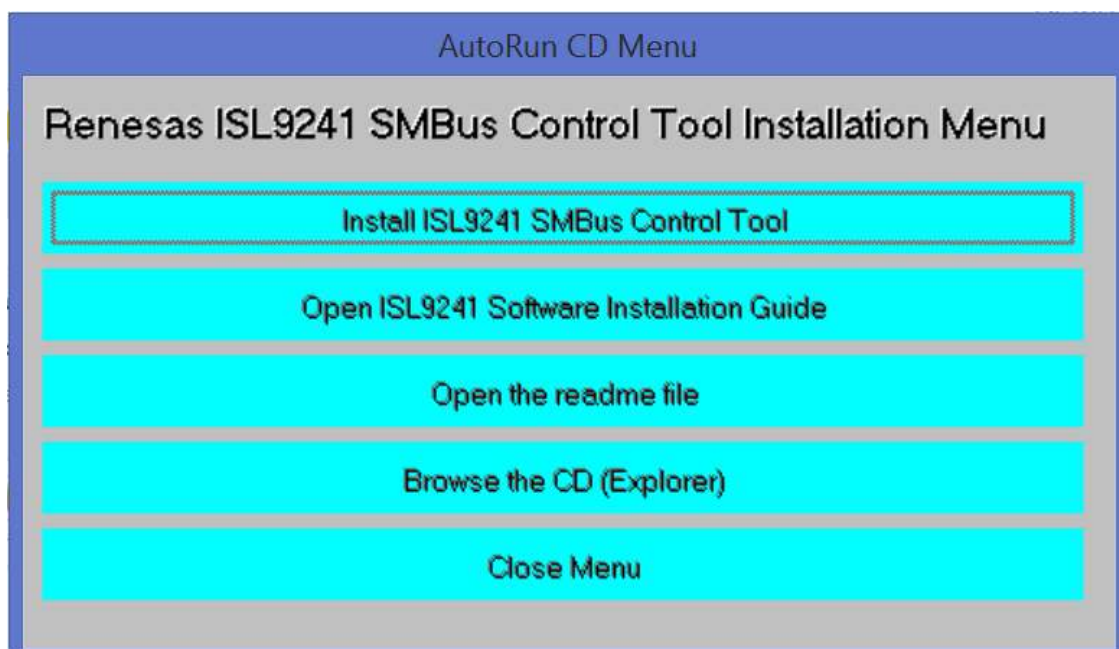

Figure 2. ISL9241 SMBus Control Tool Installation Wizard

3. Click **Install ISL9241 SMBus Control Tool**.
 - a. The window shown in [Figure 3](#) appears. Click **Next**.

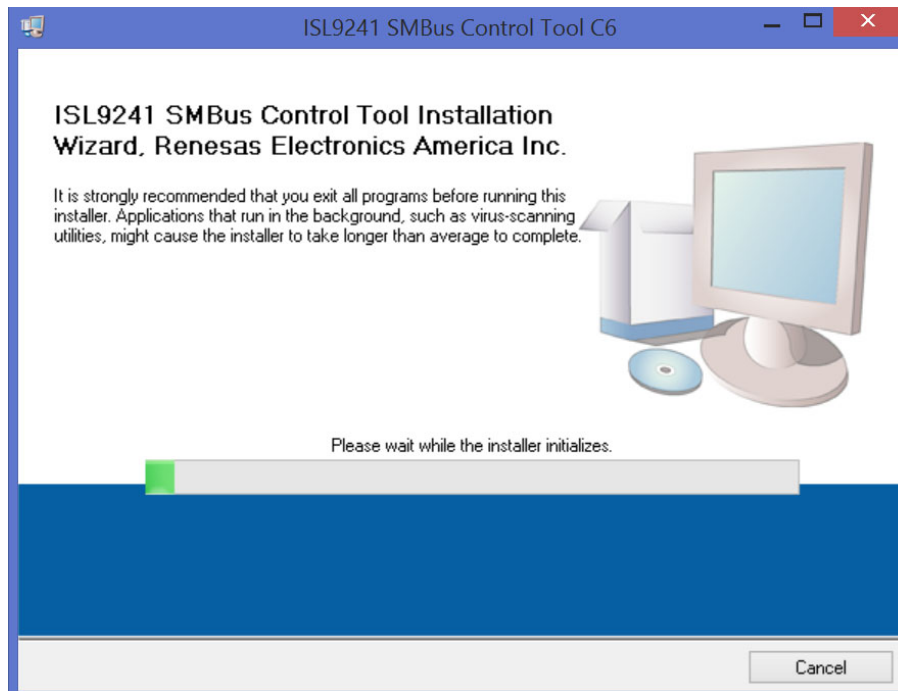

Figure 3. ISL9241 Control Software Installer

4. Follow the instructions to accept the two End User License Agreements to complete the software installation.
5. Click **Close Menu** from the installation wizard.

1.4 Installing the USB Driver

This process explains how to install the SMBus to USB interface driver.

The driver supports Microsoft Vista, Windows 7, Windows 8, and Windows 8.1 operating systems.

Note: If you installed the driver or certificate previously, skip this section.

1. Open the installation wizard package.
2. Navigate to **USB-SMBus Driver**. Right-click the **SMBus-USB-Win10.inf** file and select **Install**.

Note: Install the driver from the local drive. The driver installation fails due to network security if you install from the network drive.

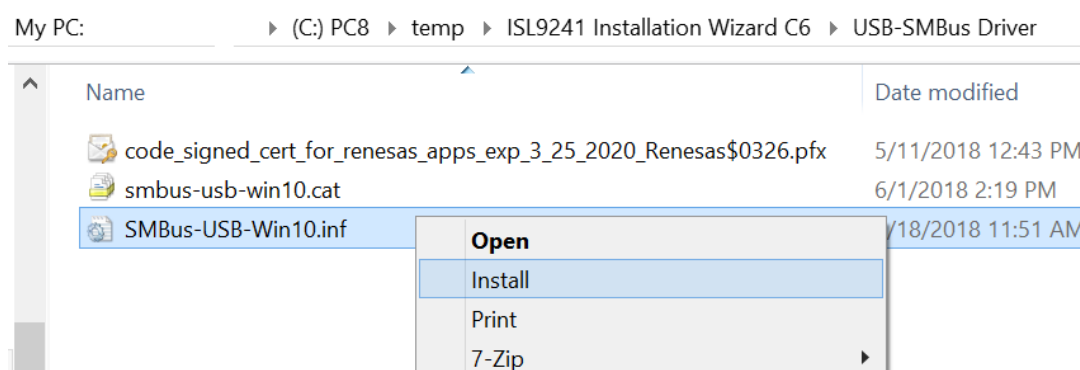

Figure 4. ISL9241 USB Driver Location

3. The message in [Figure 5](#) appears when the driver is successfully installed.

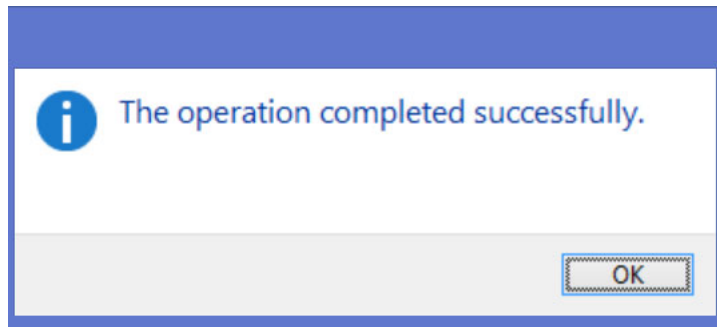

Figure 5. ISL9241 Successful Driver Installation

4. If the installation fails the Digital Signature required in Windows 10 or security settings, complete the following steps to bypass it.

Note: To complete the process, print and complete the steps below. The system restarts and these instructions are needed.

5. Open the Command Prompt from the **Start** menu.
6. Enter the command “shutdown /r /o /f /t 00” in the Command Prompt.
7. Click **OK**.
8. The system restarts to the **Choose an option** screen.
9. Select **Troubleshoot** from the **Choose an option** screen.
10. Select **Advanced options** from the **Troubleshoot** screen.
11. Select **Windows Startup Settings** from the **Advanced options** screen.
12. Click **Restart**.
13. The system restarts to the **Advanced Boot Options** screen.
14. Select **Disable Driver Signature Enforcement**.
15. Restart and install the drivers.

2. Using the GUI

The ISL9241 SMBus Control Tool Software must be installed to use the evaluation system. Do not connect the ISL9241EVAL1Z evaluation board to the USB port until installation is complete.

Connect the ISL9241EVAL1Z to a power supply before using the SMBus GUI.

2.1 Setting the USB Connection

Connect the USB cable from the USB of the computer port to the connector J₁₀ of the ISL9241EVAL1Z.

2.2 Starting the GUI

To start the GUI, navigate to the Start menu , then select **All Programs** → **Renesas** → **ISL9241 SMBus Control Tool**.

[Figure 6](#) shows the GUI.

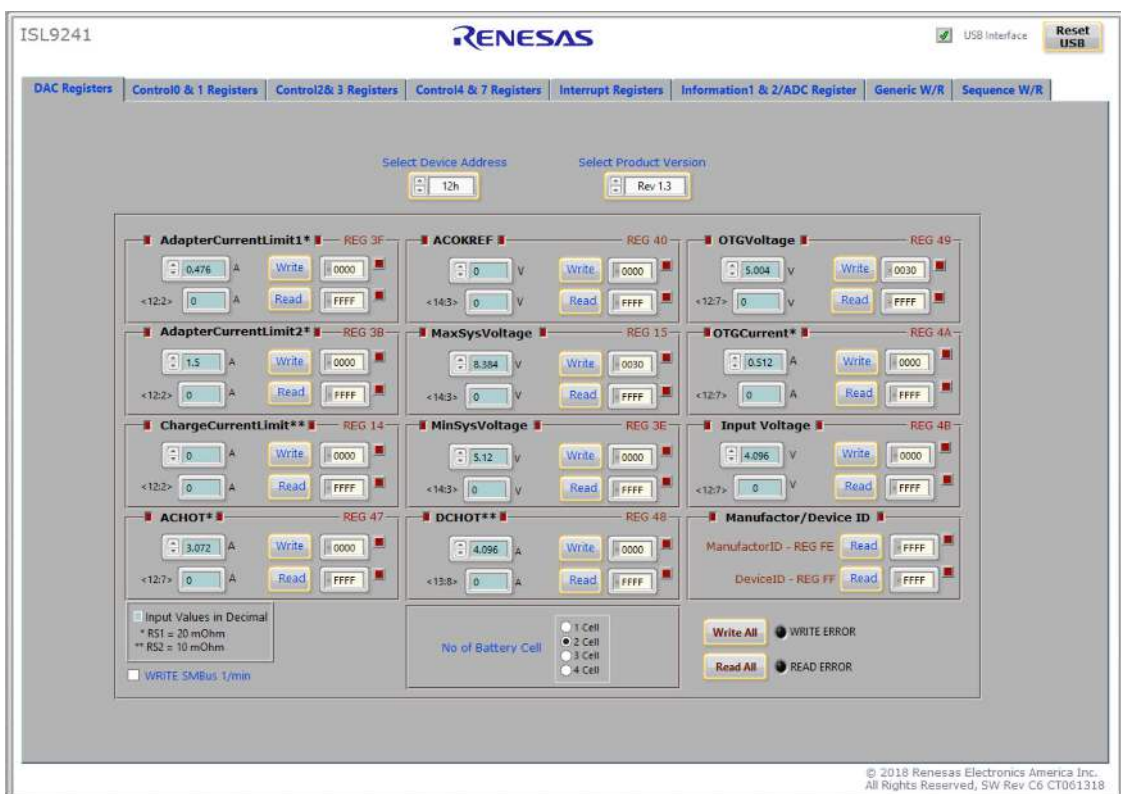

Figure 6. ISL9241 Graphical User Interface

2.3 Troubleshooting the GUI

Check the status of the USB interface at the top of the GUI. If the USB communication is OK, the **USB Interface** status shows a green check mark, as seen in [Figure 6](#).

If the **USB Interface** status shows a red X, the computer cannot establish the connection. Complete the following steps to troubleshoot:

1. Make sure the driver files for the USB interface are installed correctly. The driver files are in the **USB-I2C Driver** folder.
2. Check the USB cable connections from the ISL9241EVAL1Z to the USB port of the computer.
3. Try different sequences: plug in the ISL9241EVAL1Z first or start the GUI first.

If the problem continues, the USB driver may not be properly installed; therefore, the ISL9241EVAL1Z is not recognized. See [“Installing the USB Driver” on page 5](#) for driver installation instructions.

3. Functional Description

The ISL9241EVAL1Z evaluation board provides all circuits required to evaluate the features of the ISL9241. A majority of the features of the ISL9241 are available on the ISL9241EVAL1Z, such as adjustable output voltage, On-the-Go (OTG) mode, Trickle Charging mode for a depleted battery, and system power monitor at Buck, Boost, and Buck-Boost modes. The charger can be controlled through firmware to operate in Hybrid Power Buck-Boost or Bypass mode. See [AN1994](#), *ISL9241 Operation Modes* for detailed information about the operation modes.

3.1 Quick Start Guide

The number of battery cell and adapter current limit default values can be configured with a standard 1% 0603 resistor (R_{23}) from the PROG pin to GND. The *Prog Pin Programming Options* table in the [ISL9241](#) datasheet shows the programming options. After the default number of cells in series is set, the default values for MaxSystemVoltage and MinSystemVoltage are set accordingly. These values can also be changed through the SMBus control registers, which are implemented with the Renesas GUI shown in [Figure 8 on page 10](#).

The three LEDs indicate the ACOK, PROCHOT, and OTGPG/CMOUT status, respectively. For more details about the functions of these three pins, see the [ISL9241](#) datasheet.

Complete the following steps to evaluate the ISL9241 key functions, including system voltage regulation, input current limit regulation, Charging mode, trickle Charging mode, and OTG mode. [Figure 7 on page 9](#) shows the top view of the ISL9241EVAL1Z and highlights the key testing points and connection terminals. For more information about the ISL9241, including other operation modes, see the [ISL9241](#) datasheet and [AN1994](#).

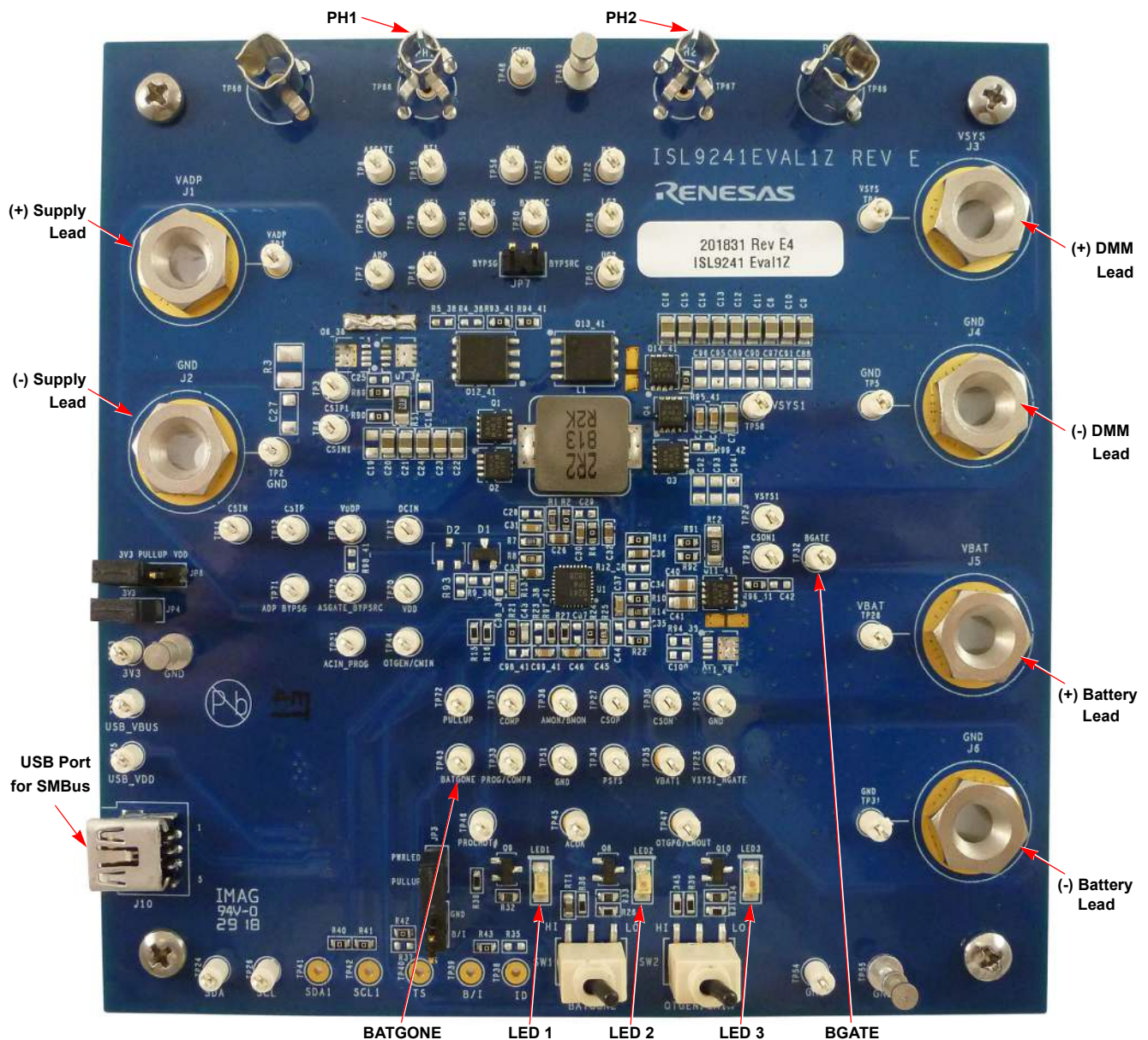

Figure 7. ISL9241EVAL1Z Connections

3.2 Regulating System Voltage

1. Set the power supply to 5V. With the output disabled, connect the (+) end to J₁ and the (-) end to J₂.
2. Ensure jumpers JP₃, JP₄, and JP₆ are shorted. SW₁ and SW₂ should switch to the low position.
3. Turn on the power supply and measure VSYS using the DMM across (+) and (-) TP₅. VSYS should read 8.38V. The current meter on the supply should read <100mA. Increase V_{IN} from 5V to 15V slowly. Monitor PH₁ and PH₂ to observe seamless switching from Boost mode to Buck-Boost mode and finally into Buck mode.

3.3 Regulating Input Current Limit

1. Keep V_{IN} as a constant value between 3.8V and 24V. Set the battery emulator voltage to 7.8V and connect the battery emulator output to battery leads J₅ and J₆.
2. Turn on the battery emulator; there is no charge and discharge current for the battery, which is consistent with BGATE FET being off.

3. Add an electrical load on VSYS and GND terminals J₃ and J₄. Turn on the load and increase the electrical load slowly; the input current increases correspondingly and VSYS keeps stable at 8.38V. The output voltage (VSYS) starts dropping as the input current reaches the 0.476A input current limit. For the input current limit details, see the [ISL9241](#) datasheet. If the VSYS voltage is 150mV lower than the battery voltage, the BGATE FET turns on at a low voltage level so that the battery supplies the current to the load.

3.4 Configuring the ISL9142EVAL1Z for Charging Mode

1. Set the power supply to a constant value between 3.8V and 24V, then complete Steps 1 and 2 in [“Regulating System Voltage” on page 9](#). Make sure the input current does not exceed the limit.
2. Set the battery emulator voltage to 7.8V and connect the battery emulator output to battery leads J₅ and J₆.
3. Connect the USB cable at the USB port for the SMBus. LED1, 2, and 3 all turn on.
4. Turn on the power supply; LED3 goes out. Turn on the battery emulator and open the Renesas ISL9241 GUI ([Figure 8](#)).

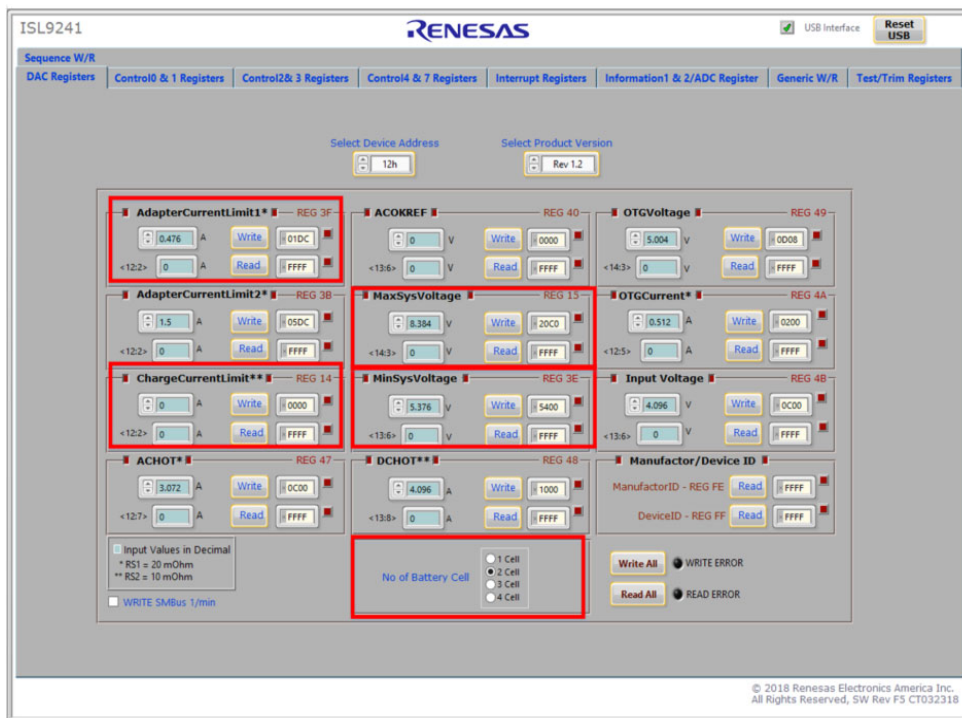

Figure 8. ISL9241 GUI

Note: A green check mark in the **USB Interface** status indicates the GUI is ready to communicate with the ISL9241EVAL1Z. If the **USB Interface** shows a red X, the GUI is not ready to communicate with the ISL9241EVAL1Z. Click the **Reset USB** button until a green check mark appears in the **USB Interface**. If the green check mark does not appear, check the USB connection. See [“Troubleshooting the GUI” on page 7](#) for troubleshooting information.

5. Select **2 Cell** in the **No of Battery Cell** section and click the **Write All** button. All controller register values are set to the default values correspondingly. The system voltage is 8.4V, which is the value of **MaxSysVoltage** in the GUI. There is no charge and discharge current for the battery. Set the minimum system voltage (**MinSysVoltage**) to a non zero value. Change the charge current limit (**ChargeCurrentLimit**) from **0A** to **2A** and click **Write**. The battery is now in 2A current charge operation. The charge current value can be monitored in the GUI by clicking **Read** in the **ChargeCurrentLimit** column. Monitor the BGATE signal status to confirm the battery is in Charging mode.
6. To turn on charging (trickle and fast/normal), set the **MinSysVoltage** register and the **ChargeCurrentLimit** register to non-zero values.

Note: Make sure the input current does not reach the input current limit value, especially for a small V_{IN} input.

3.5 Configuring the ISL9241EVAL1Z for Trickle Charging Mode

1. Complete steps 1 through 5 in [Configuring the ISL9142EVAL1Z for Charging Mode](#) without any changes. Set the **MinSysVoltage** register and the **ChargeCurrentLimit** register to non-zero values.
2. Decrease the battery emulator voltage and monitor the battery charging current. If the battery emulator voltage is less than 5.2V (lower than **MinSysVoltage**), the battery enters trickle Charging mode and the charge current decreases to 0.26A. The trickle charge current value can be changed through the SMBus control registers (see the [ISL9241](#) datasheet).

Note: Make sure the input current does not reach the input current limit value, especially for small V_{IN} input.

3.6 Configuring the ISL9241EVAL1Z for OTG Mode

1. Set the battery emulator voltage at a constant value between 5.8V and 15V. Connect battery leads J_5 and J_6 with the output disabled.
2. Connect an electric load on supply leads J_1 and J_2 with the output disabled.
3. Connect the USB cable at the USB port for SMBus. Only LED1 is on. Turn on the battery emulator and electrical load without adding any load.
4. Open the ISL9241 GUI. **OTGVoltage** is the voltage value for the load side, as shown in [Figure 9](#), and **OTGCurrent** is the OTG output current limit at the load side. You can set these values as needed within the output limit range. See the [ISL9241](#) datasheet for the limit ranges.

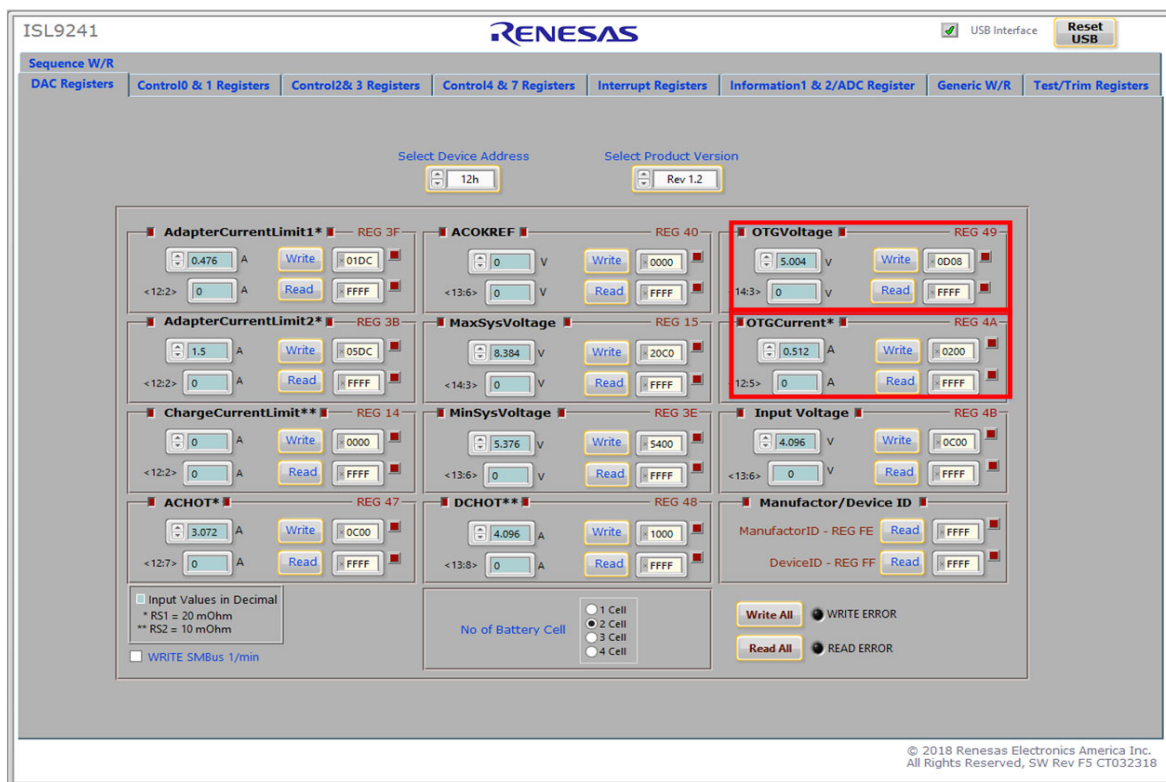

Figure 9. OTGVoltage and OTGCurrent Settings in GUI

5. Select the **Control0 & 1 Registers** tab.
6. In the **Control1 Register** column, select **1: Enable** in **OTG Function** to enable OTG, then click **Write**. See [Figure 10 on page 12](#).

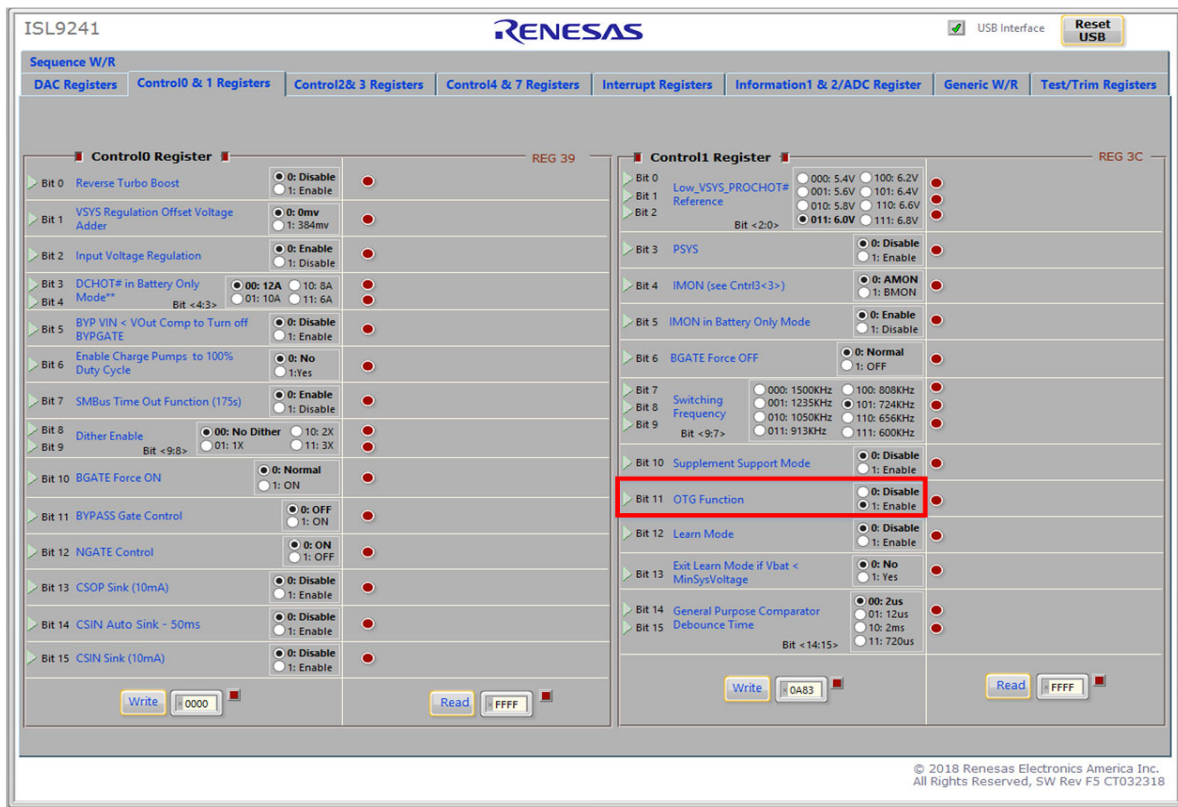

Figure 10. Enabling OTG Function

7. Switch SW₂ on the evaluation board to the HI position. The load voltage is regulated as an **OTGVoltage** value, set in Step 4. LED3 is on, indicating the OTG function is enabled.
8. Increase the electrical load slowly and monitor the load voltage. If the load current is less than the **OTGCurrent** limit value, the load voltage is regulated at the setting value.

3.7 Configuring the ISL9241EVAL1Z for Bypass Mode

See [AN1994](#) for information about how to transition between different NVDC and Bypass modes. The document also provides steps on how to enable charging in each mode and how to allow the battery to supplement the adapter in Bypass mode (reverse turbo boost).

3.8 Supplemental Mode (Intel V_{MIN} Active Protection)

See [AN1994](#) for information about how to enter Supplemental mode (Intel V_{MIN} active protection).

4. PCB Layout Guidelines

This section provides real examples of PCB layouts. The guidance is specific to board implementation, indicates key techniques used, and highlights areas that affect both functionality and performance.

4.1 ISL9241EVAL1Z Evaluation Board

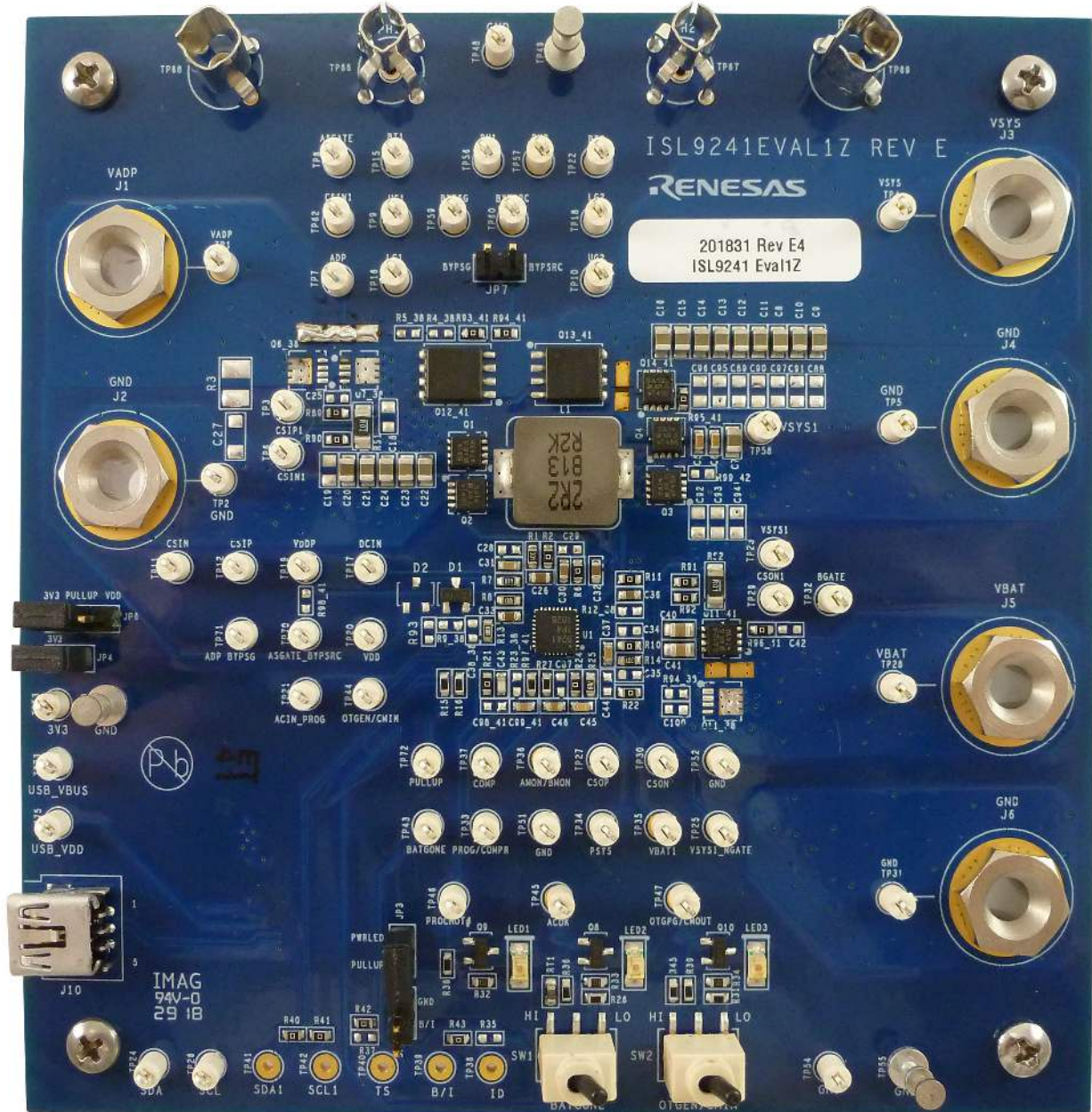

Figure 11. ISL9241EVAL1Z Evaluation Board (Top)

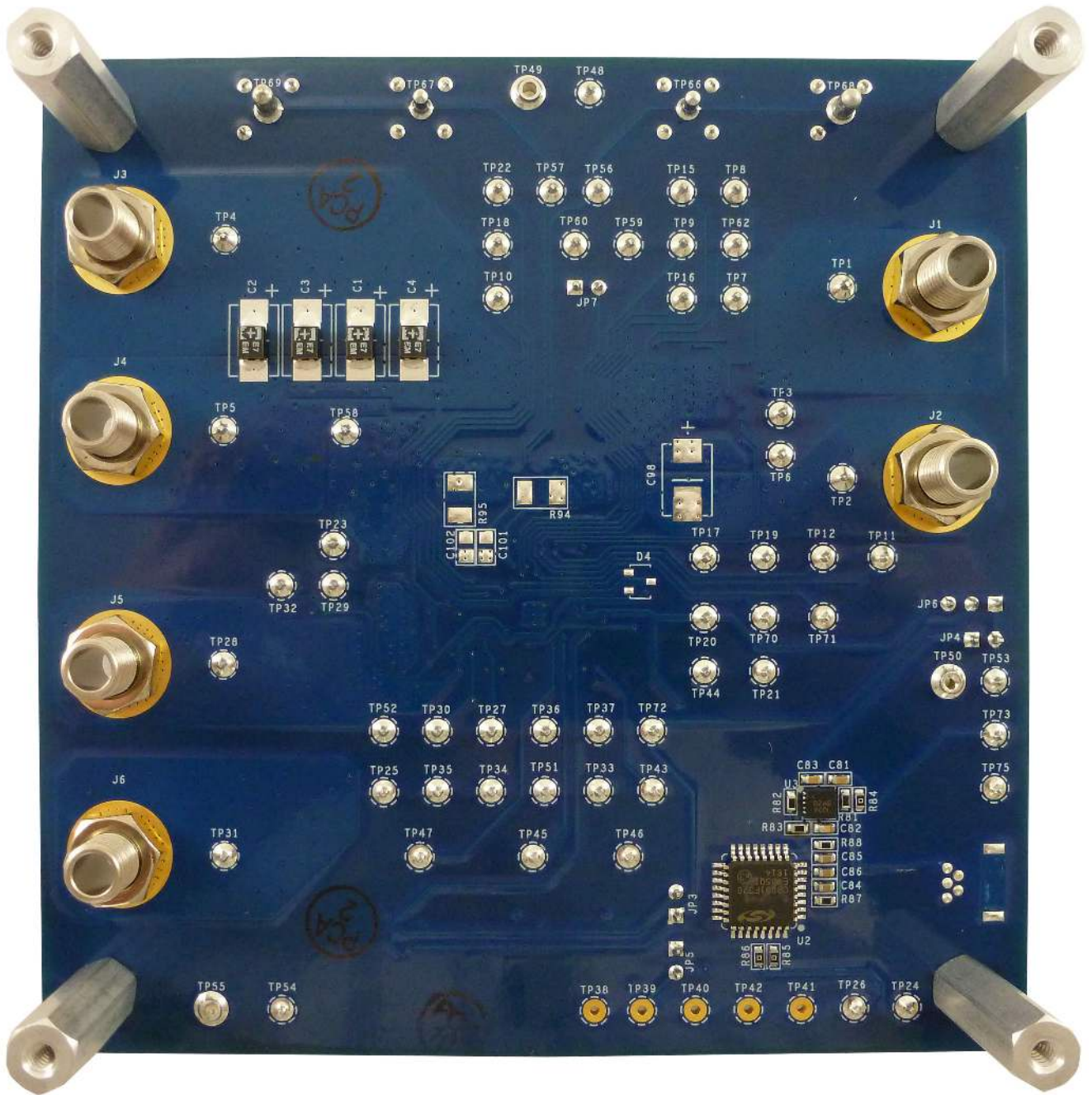

Figure 12. ISL9241EVAL1Z Evaluation Board (Bottom)

4.2 ISL9241EVAL1Z Schematic

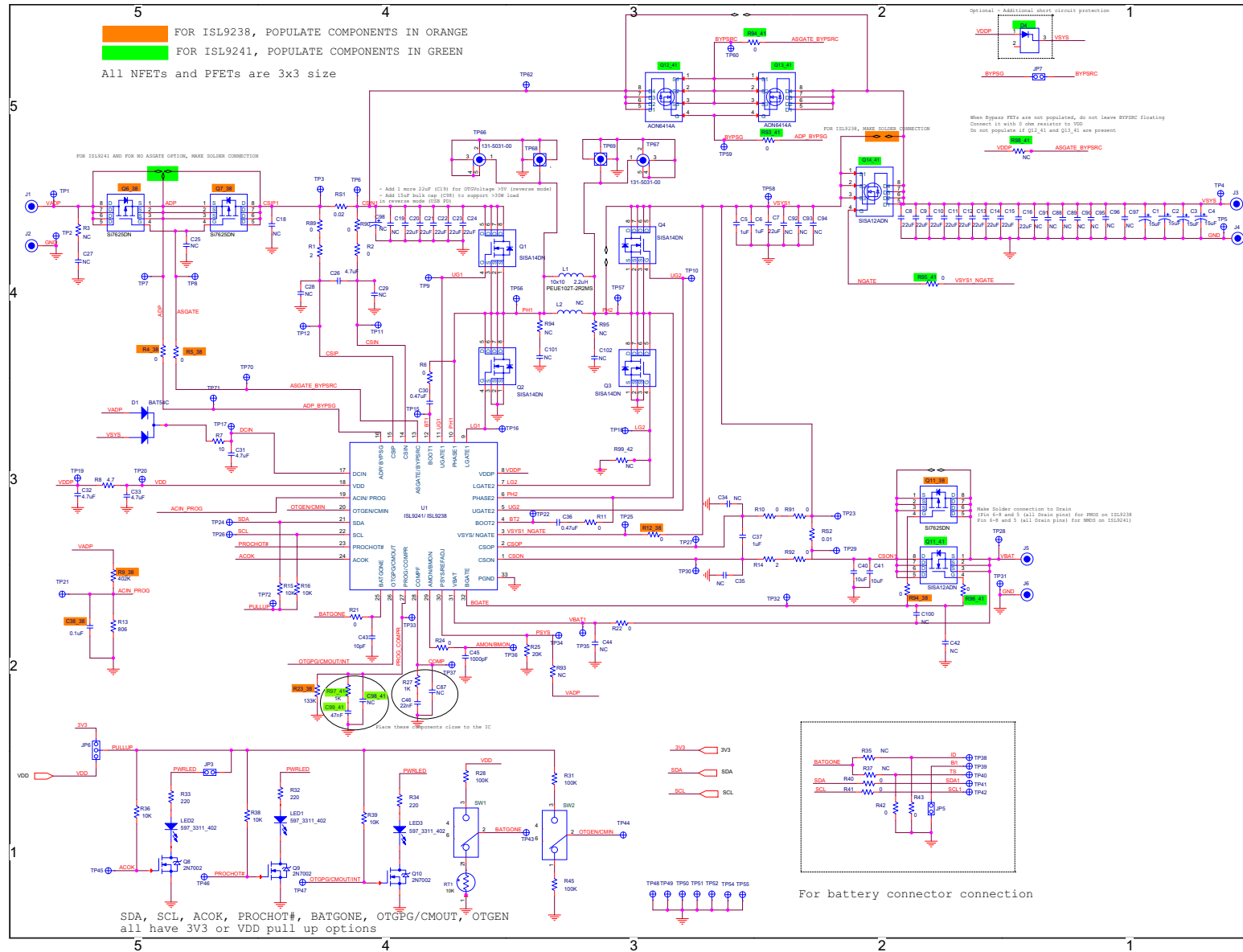

Figure 13. Schematic

4.3 Bill of Materials

Qty	Reference Designator	Description	Manufacturer	Manufacturer Part Number
1	ISL9241EVAL1Z REVD	PWB-PCB, ISL9241EVAL1Z, REVD, ROHS	Imagineering	ISL9241EVAL1Z REVC PCB
1	U1	IC-NOTEBOOK BATTERY CHARGER, 32P, QFN, 4x4, ROHS	Renesas	ISL9241HRZ
1	C43	CAP, SMD, 0603, 10pF, 50V, 10%, NP0, ROHS	Kemet	C0603C100K5GACTU
2	C45, C82	CAP, SMD, 0603, 1000pF, 16V, 10%, X7R, ROHS	AVX	0603YC102KAT2A
3	C84, C85, C86	CAP, SMD, 0603, 0.1μF, 25V, 10%, X7R, ROHS	Murata	GRM188R71E104KA01D
5	C5, C6, C37, C81, C83	CAP, SMD, 0603, 1μF, 25V, 10%, X5R, ROHS	Murata	GRM188R61E105KA12D
2	C30, C36	CAP, SMD, 0603, 0.47μF, 25V, 10%, X7R, ROHS	TDK	C1608X7R1E474K080AE
1	C46	CAP, SMD, 0603, 0.022μF, 25V, 10%, X7R, ROHS	Kemet	C0603C223K3RACTU
1	C99_41	CAP, SMD, 0603, 0.047μF, 25V, 10%, X7R, ROHS	Kemet	C0603C473K3RACTU
3	C32, C33, C26	CAP, SMD, 0603, 4.7μF, 10V, 10%, X5R, ROHS	Kemet	C0603C475K8PACTU
1	C31	CAP, SMD, 0603, 4.7μF, 35V, 10%, X5R, ROHS	Murata	GRM188R6YA475KE15D
15	C7-C14, C16, C20, C21, C22, C23, C24, C25	CAP, SMD, 0805, 22μF, 25V, 10%, X5R, ROHS	Murata	GRM21BR61E226ME44L
2	C40, C41	CAP, SMD, 0805, 10μF, 25V, 10%, X5R, ROHS	TDK	C2012X5R1E106K
4	C1, C2, C3, C4	CAP-POSCAP, SMD, B case, 15μF, 25V, 20%, 100MΩ, ROHS	Sanyo	25TQC15MYFB
1	L1	PWR CHOKE COIL, SMD, 10x10, 2.2μH, 10A, 20%, ROHS	Cyntec Co., Ltd.	PEUE102T-2R2MS
6	J1, J3, J5, J2, J4, J6	CONN BANANA JACK THREADED 12AWG	Cinch Connectivity	108-0740-102
3	TP50, TP55, TP49	Turret Binding Post	Keystone	1514-2
2	TP68, TP69	CONN-SCOPE PROBE TEST PT, COMPACT, PCB MNT, ROHS	Tektronix	131-4353-00
2	TP66, TP67	CONN-SCOPE PROBE TEST PT, COMPACT, PCB MNT, ROHS	Tektronix	131-5031-00
56	TP1-TP12, TP15-TP37, TP43-TP48, TP51-TP54, TP56-TP60, TP62, TP70-TP73, TP75	CONN-MINI TEST POINT, VERTICAL, WHITE, ROHS	Keystone	5002
1	J10	CONN-USB MINI-B RECEPTACLE, TH, 5CIRCUIT, R/A, ROHS	Molex	54819-0519
1	JP6	CONN-HEADER, 1x3, BREAKAWY 1x36, 2.54mm, ROHS	Berg/FCI	68000-236HLF
4	JP3, JP4, JP5, JP7	CONN-HEADER, 1x2, RETENTIVE, 2.54mm, 0.230x 0.120, ROHS"	Berg/FCI	69190-202HLF

Qty	Reference Designator	Description	Manufacturer	Manufacturer Part Number
3	JP3, JP4, JP6-Pins 1-2	CONN-JUMPER, SHORTING, 2PIN, BLACK, GOLD, ROHS	Sullins	SPC02SYAN
1	D1	DIODE-RECTIFIER, SMD, SOT23, 30V, 200mA, DUAL DIODE, ROHS	Diodes Incorporated	BAT54C-7-F
3	LED1, LED2, LED3	LED, SMD, 1206, GREEN, 75mW, 3mcd, 567nm, ROHS	Dialight	597-3311-407NF
1	U2	IC-USB MICROCONTROLLER, 32P, LQFP, PROGRAMMED, ROHS	Silicon Laboratories	C8051F320-GQ (Programmed in Palm Bay)
1	U3	IC-ADJ.V, 1A LDO REGULATOR, 10P, DFN, 3X3, ROHS	Renesas	ISL80101IRAJZ
3	Q8, Q9, Q10	TRANSISTOR, N-CHANNEL, 3LD, SOT-23, 60V, 115mA, ROHS	Diodes Incorporated	2N7002-7-F
4	Q1, Q2, Q3, Q4	TRANSISTOR-MOS, N-CHANNEL, 8P, PWRPAK, 30V, 20A, ROHS	Vishay	SISA14DN-T1-GE3
2	Q11_41, Q14_41	TRANSISTOR-MOS, N-CHANNEL, 8P, PWRPAK 1212-8, 30V, 25A, ROHS	Vishay	SISA12ADN-T1-GE3
2	Q12_41, Q13_41	TRANSISTOR-MOS, N-CHANNEL, 8P, 5x6, 30V, 30A, ROHS	Alpha & Omega Semiconductor Inc.	AON6414A
2	R1, R14	RES, SMD, 0603, 2Ω, 1/10W, 1%, TF, ROHS	Yageo	RC0603FR-072RL
1	R7	RES, SMD, 0603, 10Ω, 1/10W, 1%, TF, ROHS	Yageo	RC0603FR-0710RL
1	R8	RES, SMD, 0603, 4.7Ω, 1/10W, 1%, TF, ROHS	Yageo	RC0603FR-074R7L
1	RT1	NTC, THERMISTOR, 10kΩ, 1%, 0603, ROHS	Murata	NCP18XH103F03RB
22	R2, R6, R10, R11, R21, R22, R24, R40, R41, R42, R43, R84, R85, R86, R89, R90, R91, R92, R96_41, R93_41, R94_41, R95_41	RES, SMD, 0603, 0Ω, 1/10W, TF, ROHS	Yageo	RC0603JR-070RL
4	R83, R87, R88, R27	RES, SMD, 0603, 1k, 1/10W, 1%, TF, ROHS	Yageo	RC0603FR-071KL
1	R97_41	RES, SMD, 0603, 1k, 1/10W, 1%, TF, ROHS	Yageo	RC0603FR-071KL
6	R15, R16, R36, R38, R39, R81	RES, SMD, 0603, 10k, 1/10W, 1%, TF, ROHS	Yageo	RC0603FR-0710KL
3	R28, R31, R45	RES, SMD, 0603, 100k, 1/10W, 1%, TF, ROHS	Yageo	RC0603JR-07100KL
1	R13	RES, SMD, 0603, 806Ω, 1/10W, 1%, TF, ROHS	Yageo	RC0603FR-07806RL
3	R32, R33, R34	RES, SMD, 0603, 220Ω, 1/10W, 1%, TF, ROHS	Yageo	RC0603FR-07220RL
1	R82	RES, SMD, 0603, 5.62k, 1/10W, 1%, TF, ROHS	Panasonic	ERJ-3EKF5621V
1	R25	RES, SMD, 0603, 20k, 1/10W, 1%, TF, ROHS	Yageo	RC0603FR-0720KL

Qty	Reference Designator	Description	Manufacturer	Manufacturer Part Number
1	RS2	RES-CURR.SENSE, SMD, 1206, 0.01Ω, 1W, 1%, 75ppm, ROHS	Vishay/Dale	WSLP1206R0100FEA
1	RS1	RES-CURR.SENSE, SMD, 1206, 0.02Ω, 1W, 1%, 75ppm, ROHS	Vishay/Dale	WSLP1206R0200FEA
2	SW1,SW2	SWITCH-TOGGLE, SMD, 6PIN, SPDT, 2POS, ON-NONE-ON, ROHS	ITT Industries/C&K Division	GT11MSCBE
4	Four corners	SCREW,4-40X1/4in, PHILLIPS, PANHEAD, STAINLESS, ROHS	Building Fasteners	PMSSS 440 0025 PH
4	Four corners	STANDOFF,4-40X3/4in, F/F, HEX, ALUMINUM, 0.25 OD, ROHS	Keystone	2204
1	Place assy in bag	BAG, STATIC, 5x8, ZIPLOC, ROHS	Renesas	212403-013
0	L2	Do Not Populate or Purchase		
0	R3, R35, R37, R4_38, R5_38, R12_38, R23_38, R9_38, R93, R98_41, R94_38, R99_42, R94, R95	Do Not Populate or Purchase		
0	TP38-TP42	Do Not Populate or Purchase		
0	C18, C19, C25, C27, C28, C29, C34, C35, C42, C87, C98, C98_41, C38_38, C44, C88-C97, C100, C101, C102	Do Not Populate or Purchase		
0	Q6_38, Q7_38, Q11_38	Do Not Populate or Purchase		
0	D4	Do Not Populate or Purchase		
1	Affix to Back of PCB	LABEL-DATE CODE_LINE 1: YRWK/REV#, LINE 2: BOM NAME	Renesas	LABEL-DATE CODE
1	Rename PCB to: ISL9241EVAL1Z REV E	LABEL, TO RENAME BOARD	Renesas	LABEL-RENAME BOARD

Table 1. Guidelines for PCB Layout

Pin #	Pin Name	Layout Guidelines
Bottom Pad	GND	Connect this ground pad to the ground plane through a low impedance path. Renesas recommends using at least five vias to connect to ground planes in the PCB to ensure sufficient thermal dissipation directly under the IC.
1 2	CSON CSOP	<p>Run two dedicated traces with sufficient width in parallel (close to each other to minimize the loop area) from the two terminals of the battery current-sensing resistor to the IC. Place the differential mode and common-mode RC filter components in the general proximity of the controller.</p> <p>Route the current-sensing traces through vias to connect the center of the pads or route the traces into the pads from the inside of the current-sensing resistor. The following drawings show the two preferred ways of routing current-sensing traces.</p>  <p style="text-align: center;"> Vias Current-Sensing Traces Current-Sensing Traces </p>
3	NGATE	Switching pin. Run the NGATE trace to the NGATE N-type MOSFET Gate node. Use sufficient width. Do not allow any sensitive analog signal traces to cross over or get close.

Table 1. Guidelines for PCB Layout (Continued)

Pin #	Pin Name	Layout Guidelines
4	BOOT2	Switching pin. Place the bootstrap capacitor in the general proximity of the controller. Use a sufficiently wide trace. Do not allow any sensitive analog signal traces to cross over or get close.
5	UGATE2	Run these two traces in parallel with sufficient width. Do not allow any sensitive analog signal traces to cross over or get close. Renesas recommends routing the PHASE2 trace to the high-side MOSFET source pin instead of general copper. Place the IC close to the gate terminals of the switching MOSFETs and keep the gate drive signal traces short for a clean MOSFET drive. The IC can be placed on the opposite side of the switching MOSFETs. Place the output capacitors as close as possible to the switching high-side MOSFET drain and the low-side MOSFET source. Use the shortest PCB trace connection. Place these capacitors on the same PCB layer as the MOSFETs instead of on different layers and using vias to make the connection. Place the inductor terminal to the switching high-side MOSFET drain and low-side MOSFET source terminal as close as possible. Minimize this phase node area to reduce the electrical and magnetic field radiation but make this phase node area large enough to carry the current. Place the inductor and the switching MOSFETs on the same layer of the PCB.
6	PHASE2	
7	LGATE2	Switching pin. Run the LGATE2 trace in parallel with the UGATE2 and PHASE2 traces on the same PCB layer. Use sufficient width. Do not allow any sensitive analog signal traces to cross over or get close.
8	VDDP	Place the decoupling capacitor in the general proximity of the controller. Run the trace connecting to the VDD pin with sufficient width.
9	LGATE1	Switching pin. Run the LGATE1 trace in parallel with the UGATE1 and PHASE1 traces on the same PCB layer. Use sufficient width. Do not allow any sensitive analog signal traces to cross over or get close.
10	PHASE1	Run these two traces in parallel with sufficient width. Do not allow any sensitive analog signal traces to cross over or get close. Renesas recommends routing the PHASE1 trace to the high-side MOSFET source pin instead of general copper. Place the IC close to the gate terminals of the switching MOSFETs and keep the gate drive signal traces short for a clean MOSFET drive. The IC can be placed on the opposite side of the switching MOSFETs. Place the input capacitors as close as possible to the switching high-side MOSFET drain and the low-side MOSFET source. Use the shortest PCB trace connection. Place these capacitors on the same PCB layer as the MOSFETs instead of on different layers and using vias to make the connection. Place the inductor terminal to the switching high-side MOSFET drain and low-side MOSFET source terminal as close as possible. Minimize this phase node area to reduce the electrical and magnetic field radiation but make this phase node area large enough to carry the current. Place the inductor and the switching MOSFETs on the same layer of the PCB.
11	UGATE1	
12	BOOT1	Switching pin. Place the bootstrap capacitor in the general proximity of the controller. Use a sufficiently wide trace. Do not allow any sensitive analog signal traces to cross over or get close.
13	BYP SRC	Run this trace with sufficient width to the bypass N-type MOSFET Sources/reference node.
14	CSIN	Run two dedicated traces with sufficient width in parallel (close to each other to minimize the loop area) from the two terminals of the adapter current-sensing resistor to the IC. Place the Differential mode and common-mode RC filter components in the general proximity of the controller. Keep the CSIN node near the Q1 drain. Route the current-sensing traces through vias to connect the center of the pads or route the traces into the pads from the inside of the current-sensing resistor. The following drawings show the two preferred ways of routing current-sensing traces.
15	CSIP	
		
16	BYP SG	Run this trace with sufficient width to the bypass N-type MOSFET Gates
17	DCIN	Place the OR diodes and the RC filter in the general proximity of the controller. Run the VADP trace and VSYS trace to the OR diodes with sufficient width.
18	VDD	Place the RC filter connecting with the VDDP pin in the general proximity of the controller. Run the trace connecting to VDDP pin with sufficient width.
19	PROG	Signal pin. Place the PROG programming resistor in the general proximity of the controller.
20	OTGEN/CMIN	Digital pins. No special consideration.

Table 1. Guidelines for PCB Layout (Continued)

Pin #	Pin Name	Layout Guidelines
21	SDA	Digital pins. No special consideration. Run the SDA and SCL traces in parallel.
22	SCL	
23	PROCHOT#	Digital pin, open-drain output. No special consideration.
24	ACOK	Digital pin, open-drain output. No special consideration.
25	BATGONE/NTC	Digital pin (BATGONE), analog pin (NTC). Place the 10kΩ resistor series in the BATGONE signal trace and the optional decoupling capacitor in the general proximity of the controller.
26	CMOUT/INT#	Digital pin, open-drain output. No special consideration.
27	COMPR	Place the compensation components in the general proximity of the controller. Do not allow any switching signal to cross over or get close.
28	COMPF	Place the compensation components in the general proximity of the controller. Do not allow any switching signal to cross over or get close.
29	AMON/BMON	No special consideration. Place the optional RC filter in the general proximity of the controller.
30	PSYS(REFADJ)	Signal pin, current source output. No special consideration. REFADJ is an analog signal pin for output voltage feedback. Place near the controller and run a dedicated trace for each resistor divider node (TOP, MIDDLE, and BOTTOM). Do not inject noise or additional capacitance.
31	VBAT	Place the optional RC filter in the general proximity of the controller. Run a dedicated trace from the battery positive connection point to the IC.
32	BGATE	Use a sufficiently wide trace from the IC to the BGATE N-type MOSFET gate. Place the capacitor from BGATE to ground close to the MOSFET.

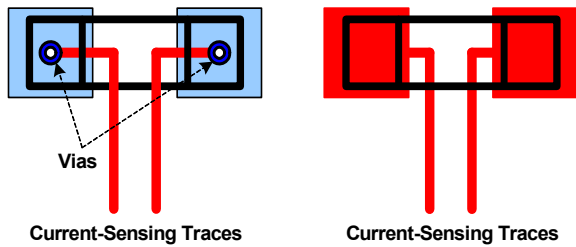
4.4 Board Layout

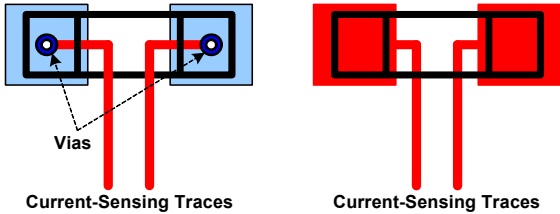
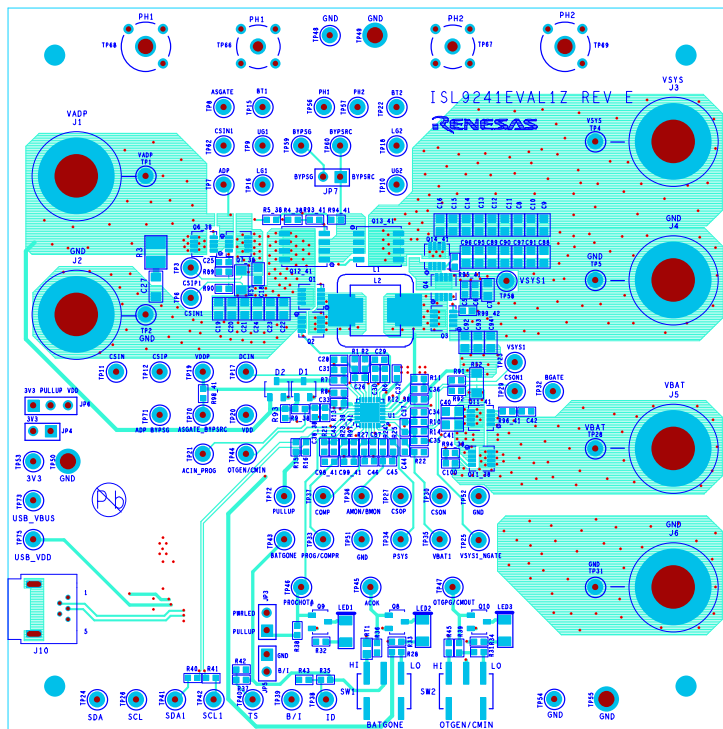

Figure 14. Silkscreen Top Layer

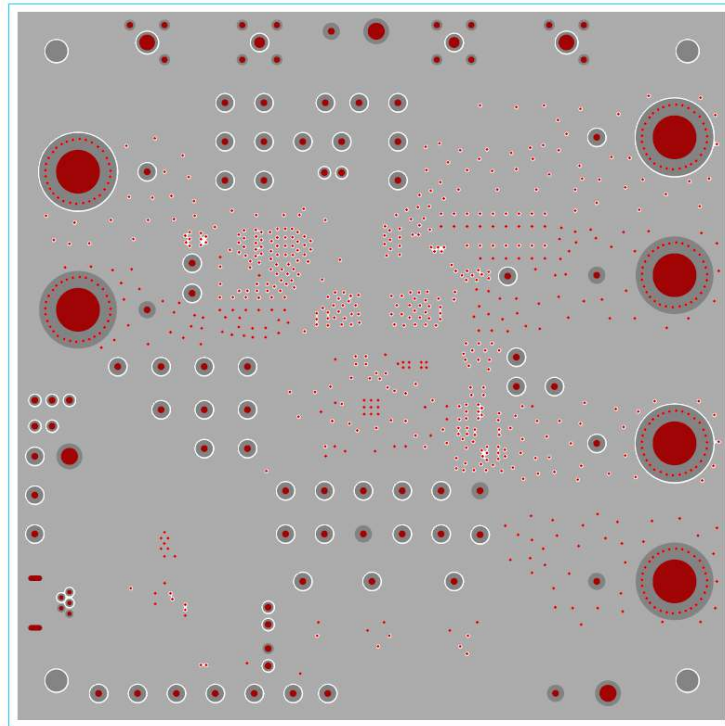

Figure 15. Inner Layer 1

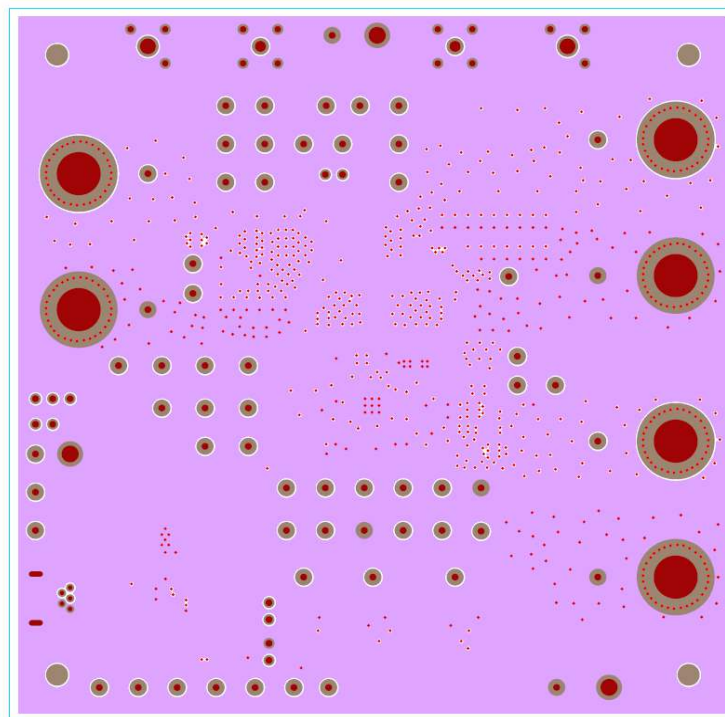

Figure 16. Inner Layer 2

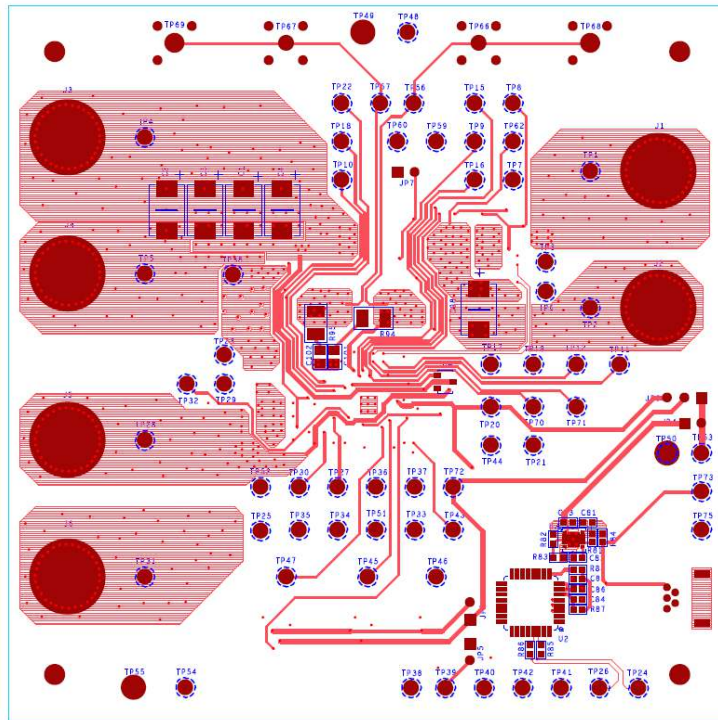

Figure 17. Bottom Layer (Mirror Image)

5. Typical Performance Curves

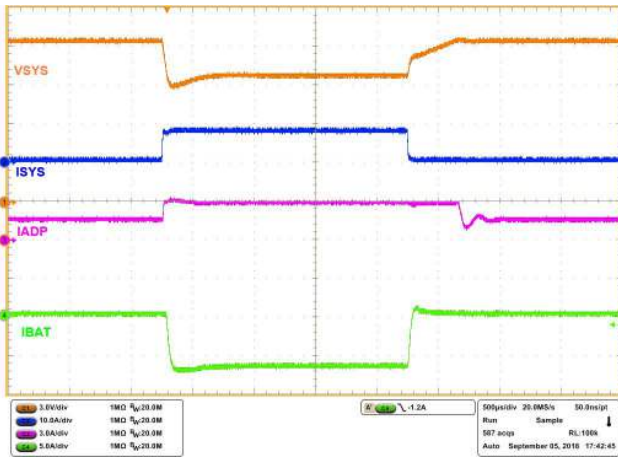

Figure 18. Boost Mode, output voltage loop to adapter current loop transition, $V_{ADP} = 5V$, $V_{BAT} = 11V$, MaxsystemVoltage = 12.576V, Adapter_current_limit = 3A, Charge_current = 0A, System_load = 0.5A to 8A

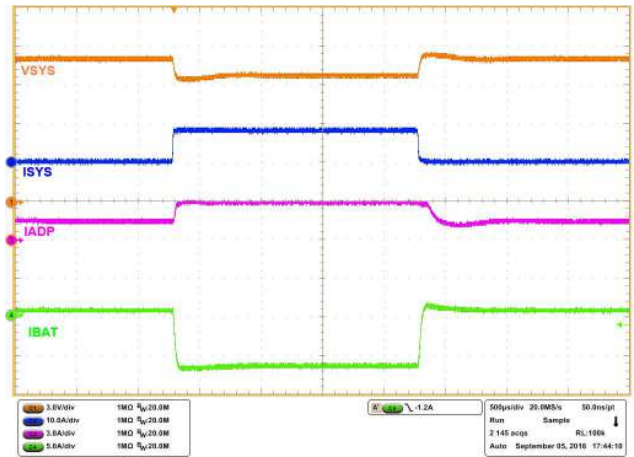

Figure 19. Boost Mode, charge current loop to adapter current loop transition, $V_{ADP} = 5V$, $V_{BAT} = 11V$, MaxsystemVoltage = 12.576V, Adapter_current_limit = 3A, Charge_current = 0.5A, System_load = 0.5A to 8A

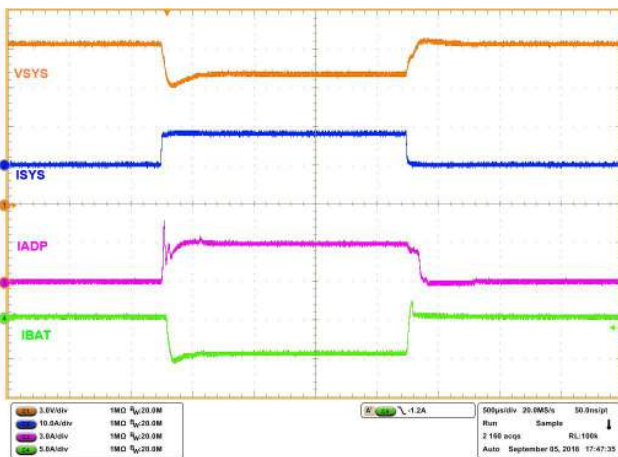

Figure 20. Buck-Boost Mode, output voltage loop to adapter current loop transition, $V_{ADP} = 12V$, $V_{BAT} = 11V$, MaxsystemVoltage = 12.576V, Adapter_current_limit = 3A, Charge_current = 0A, System_load = 0A to 8A

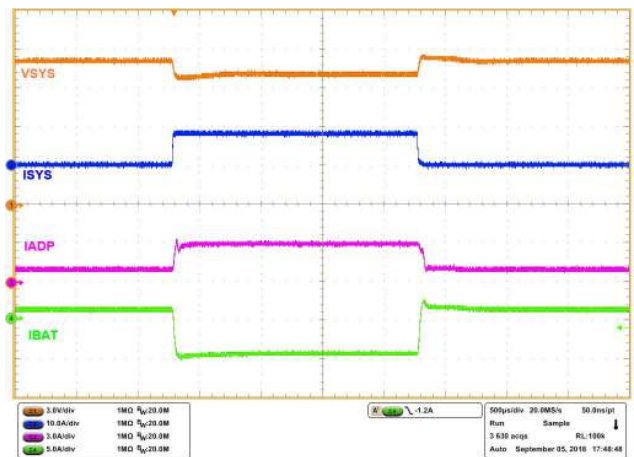

Figure 21. Buck_Boost Mode, charge current loop to adapter current loop transition, $V_{ADP} = 12V$, $V_{BAT} = 11V$, MaxsystemVoltage = 12.576V, Adapter_current_limit = 3A, Charge_current = 1A, System_load = 0A to 8A

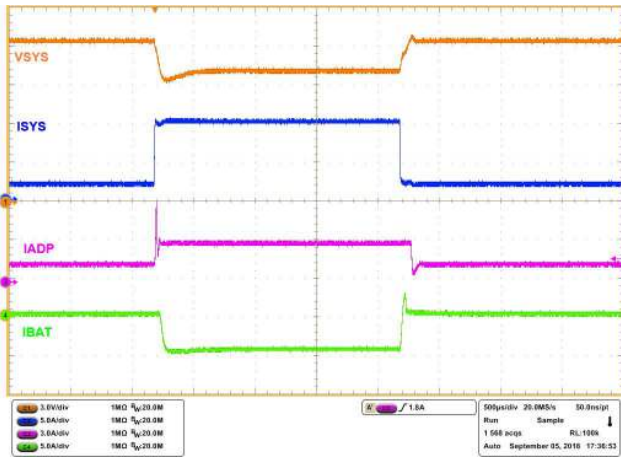

Figure 22. Buck Mode, output voltage loop to adapter current loop transition, $V_{ADP} = 20V$, $V_{BAT} = 11V$, MaxsystemVoltage = 12.576V, Adapter_current_limit = 3A, Charge_current = 0A, System_load = 2A to 10A

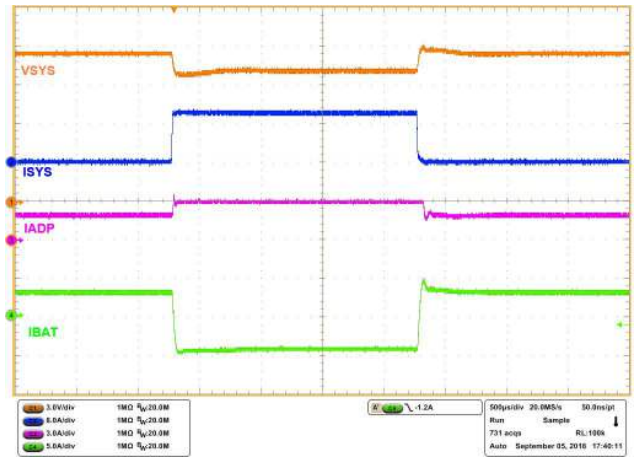

Figure 23. Buck Mode, charge current loop to adapter current loop transition, $V_{ADP} = 20V$, $V_{BAT} = 11V$, MaxsystemVoltage = 12.576V, Adapter_current_limit = 3A, Charge_current = 3A, System_load = 0A to 10A

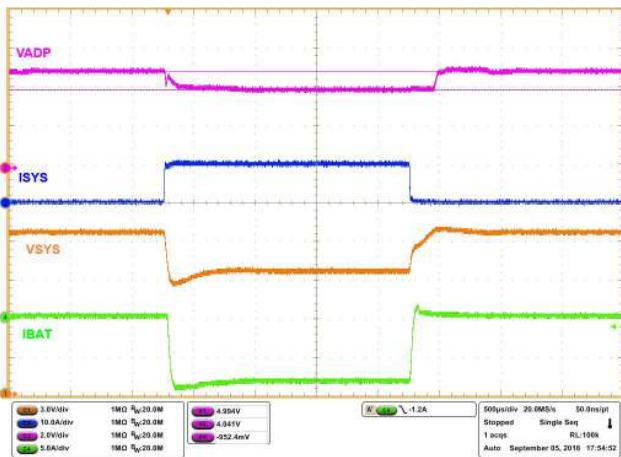

Figure 24. Boost Mode, output voltage loop to input voltage loop transition, $V_{ADP} = 5V$, $V_{BAT} = 11V$, MaxsystemVoltage = 12.576V, Charge_current = 0A, System_load = 0A to 10A, Input_voltage_DAC= 4.00V

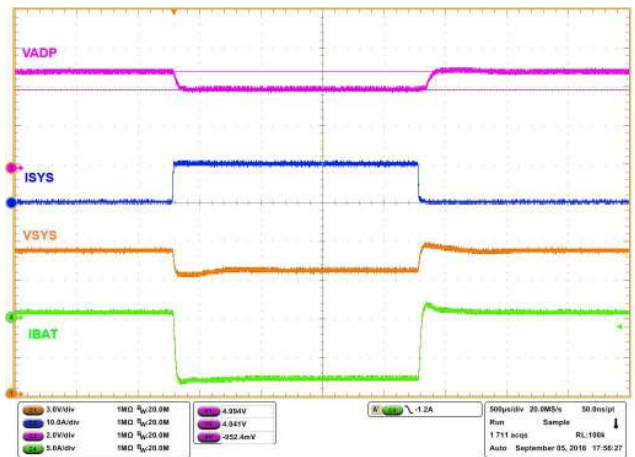

Figure 25. Boost Mode, charge current loop to input voltage loop transition, $V_{ADP} = 5V$, $V_{BAT} = 11V$, MaxsystemVoltage = 12.576V, Charge_current = 0.5A, System_load = 0A to 10A, Input_voltage_DAC= 4.00V



Figure 26. OTG mode enable using OTGEN pin. $V_{BAT} = 11V$, $V_{OTG} = 5V$, general purpose comparator disabled, OTGEN Control bit enabled

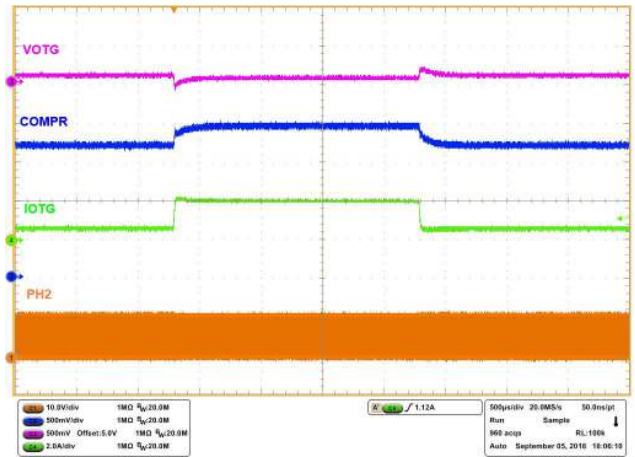

Figure 27. OTG mode transient. $V_{BAT} = 11V$, $V_{OTG} = 5V$, load = 0.5A to 2A

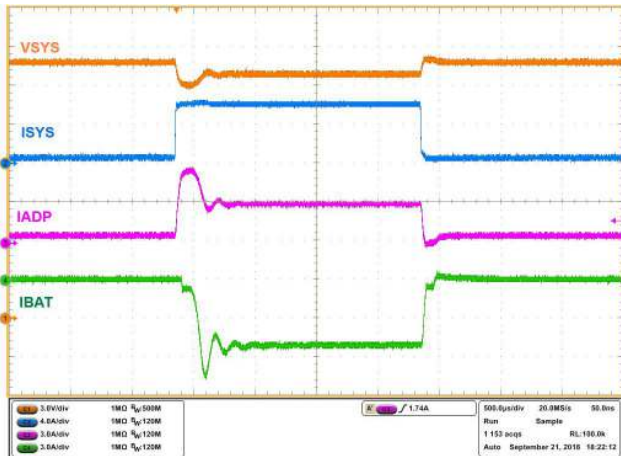

Figure 28. Bypass (HPBB) mode, reverse turbo boost enabled. Output voltage loop to adapter current limit loop transition. $V_{ADP} = 20V$, $V_{BAT} = 12V$, MaxsystemVoltage = 13.04V, Adapter_current_limit = 3A, Charge_current = 0A, System_load = 0.5A to 6A

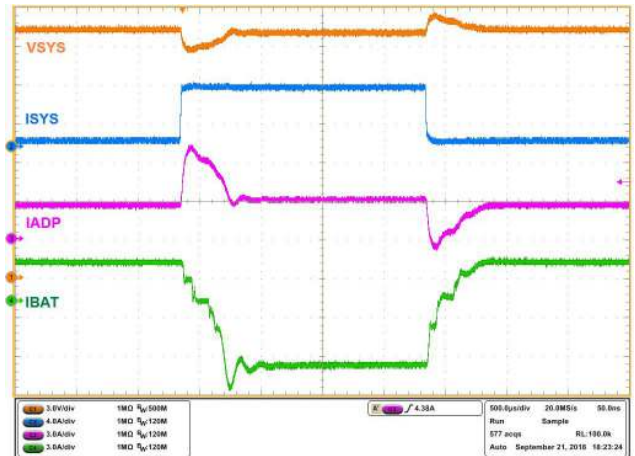

Figure 29. Bypass (HPBB) mode, reverse turbo boost enabled. Charge current loop to adapter current limit loop transition. $V_{ADP} = 20V$, $V_{BAT} = 12V$, MaxsystemVoltage = 13.04V, Adapter_current_limit = 3A, Charge_current = 3A, System_load = 0.5A to 6A

6. Revision History

Rev.	Date	Description
3.00	Aug.26.19	Applied new formatting. Updated links throughout. Updated schematic. Updated BOM.
2.00	Oct.22.18	Updated schematic.
1.00	Oct.11.18	Added schematic on page 17. Added Bill of Materials starting on page 18. Added Typical Performance Curves starting on page 25.
0.00	Aug.21.18	Initial release.

Notice

1. Descriptions of circuits, software and other related information in this document are provided only to illustrate the operation of semiconductor products and application examples. You are fully responsible for the incorporation or any other use of the circuits, software, and information in the design of your product or system. Renesas Electronics disclaims any and all liability for any losses and damages incurred by you or third parties arising from the use of these circuits, software, or information.
2. Renesas Electronics hereby expressly disclaims any warranties against and liability for infringement or any other claims involving patents, copyrights, or other intellectual property rights of third parties, by or arising from the use of Renesas Electronics products or technical information described in this document, including but not limited to, the product data, drawings, charts, programs, algorithms, and application examples.
3. No license, express, implied or otherwise, is granted hereby under any patents, copyrights or other intellectual property rights of Renesas Electronics or others.
4. You shall not alter, modify, copy, or reverse engineer any Renesas Electronics product, whether in whole or in part. Renesas Electronics disclaims any and all liability for any losses or damages incurred by you or third parties arising from such alteration, modification, copying or reverse engineering.
5. Renesas Electronics products are classified according to the following two quality grades: "Standard" and "High Quality". The intended applications for each Renesas Electronics product depends on the product's quality grade, as indicated below.
 - "Standard": Computers; office equipment; communications equipment; test and measurement equipment; audio and visual equipment; home electronic appliances; machine tools; personal electronic equipment; industrial robots; etc.
 - "High Quality": Transportation equipment (automobiles, trains, ships, etc.); traffic control (traffic lights); large-scale communication equipment; key financial terminal systems; safety control equipment; etc.Unless expressly designated as a high reliability product or a product for harsh environments in a Renesas Electronics data sheet or other Renesas Electronics document, Renesas Electronics products are not intended or authorized for use in products or systems that may pose a direct threat to human life or bodily injury (artificial life support devices or systems; surgical implantations; etc.), or may cause serious property damage (space system; undersea repeaters; nuclear power control systems; aircraft control systems; key plant systems; military equipment; etc.). Renesas Electronics disclaims any and all liability for any damages or losses incurred by you or any third parties arising from the use of any Renesas Electronics product that is inconsistent with any Renesas Electronics data sheet, user's manual or other Renesas Electronics document.
6. When using Renesas Electronics products, refer to the latest product information (data sheets, user's manuals, application notes, "General Notes for Handling and Using Semiconductor Devices" in the reliability handbook, etc.), and ensure that usage conditions are within the ranges specified by Renesas Electronics with respect to maximum ratings, operating power supply voltage range, heat dissipation characteristics, installation, etc. Renesas Electronics disclaims any and all liability for any malfunctions, failure or accident arising out of the use of Renesas Electronics products outside of such specified ranges.
7. Although Renesas Electronics endeavors to improve the quality and reliability of Renesas Electronics products, semiconductor products have specific characteristics, such as the occurrence of failure at a certain rate and malfunctions under certain use conditions. Unless designated as a high reliability product or a product for harsh environments in a Renesas Electronics data sheet or other Renesas Electronics document, Renesas Electronics products are not subject to radiation resistance design. You are responsible for implementing safety measures to guard against the possibility of bodily injury, injury or damage caused by fire, and/or danger to the public in the event of a failure or malfunction of Renesas Electronics products, such as safety design for hardware and software, including but not limited to redundancy, fire control and malfunction prevention, appropriate treatment for aging degradation or any other appropriate measures. Because the evaluation of microcomputer software alone is very difficult and impractical, you are responsible for evaluating the safety of the final products or systems manufactured by you.
8. Please contact a Renesas Electronics sales office for details as to environmental matters such as the environmental compatibility of each Renesas Electronics product. You are responsible for carefully and sufficiently investigating applicable laws and regulations that regulate the inclusion or use of controlled substances, including without limitation, the EU RoHS Directive, and using Renesas Electronics products in compliance with all these applicable laws and regulations. Renesas Electronics disclaims any and all liability for damages or losses occurring as a result of your noncompliance with applicable laws and regulations.
9. Renesas Electronics products and technologies shall not be used for or incorporated into any products or systems whose manufacture, use, or sale is prohibited under any applicable domestic or foreign laws or regulations. You shall comply with any applicable export control laws and regulations promulgated and administered by the governments of any countries asserting jurisdiction over the parties or transactions.
10. It is the responsibility of the buyer or distributor of Renesas Electronics products, or any other party who distributes, disposes of, or otherwise sells or transfers the product to a third party, to notify such third party in advance of the contents and conditions set forth in this document.
11. This document shall not be reprinted, reproduced or duplicated in any form, in whole or in part, without prior written consent of Renesas Electronics.
12. Please contact a Renesas Electronics sales office if you have any questions regarding the information contained in this document or Renesas Electronics products.

(Note1) "Renesas Electronics" as used in this document means Renesas Electronics Corporation and also includes its directly or indirectly controlled subsidiaries.

(Note2) "Renesas Electronics product(s)" means any product developed or manufactured by or for Renesas Electronics.

(Rev.4.0-1 November 2017)

Corporate Headquarters

TOYOSU FORESIA, 3-2-24 Toyosu,
Koto-ku, Tokyo 135-0061, Japan
www.renesas.com

Trademarks

Renesas and the Renesas logo are trademarks of Renesas Electronics Corporation. All trademarks and registered trademarks are the property of their respective owners.

Contact Information

For further information on a product, technology, the most up-to-date version of a document, or your nearest sales office, please visit:
www.renesas.com/contact/

ISL9241EVAL1Z