

### FD6-36

#### Description:

The FD6-36 Quick Pack small power transformer offers a significant reduction in size and weight over a standard transformer. This transformer can be used for a wide variety of applications. It is bobbin wound for reduced size and small operating space.

#### Electrical Specifications (@25C):

**Maximum Power:** 30.0VA

**Input Voltage:**

**Series:** 230VAC@50/60Hz

**Parallel:** 115VAC@50/60Hz

**Output Voltage:** 36.0VCT@0.85A<sup>1</sup>

**Recommended Fuse:** UL listed 250VAC, 1.0A, Slo-Blo

**Hipot:** 2500VAC primary to secondary; 1500VAC windings to core.

#### Construction:

Split bobbin non concentric winding eliminates costly electrostatic shielding. Termination is suitable for quick connects or soldering. Built with UL Class B Insulation System.

#### Safety:

UL: File E53148, UL 5085-1 and 2 (formerly UL 506), General Purpose.

UL: File E65390, UL5085-1 and 3, Class 3



#### Dimensions:

A	B	C	D	E	F	G
1.937	2.812	3.250	1.687	2.312	.187 Dia	1.062

**Notes:** 1. Units: inches.

2. Terminal size: .187" X 0.021".

3. Weight: 1.10 lbs

#### Schematic:

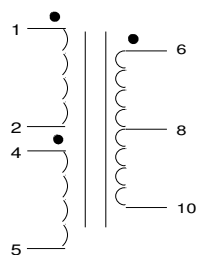

**Output:** 6 & 10

**Input (115V):** Input 1 & 2

Connect 1&4, 2&5

**Input (230V):** Input 1 & 5

Connect 2&4

**RoHS Compliance:** As of manufacturing date February 2016, all standard products meet the requirements of 2015/863/EU, known as the RoHS 3 initiative.

\* Upon printing, this document is considered "uncontrolled". Please contact Triad Magnetics' website for the most current version.

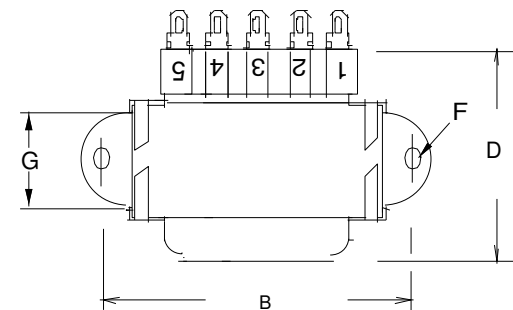
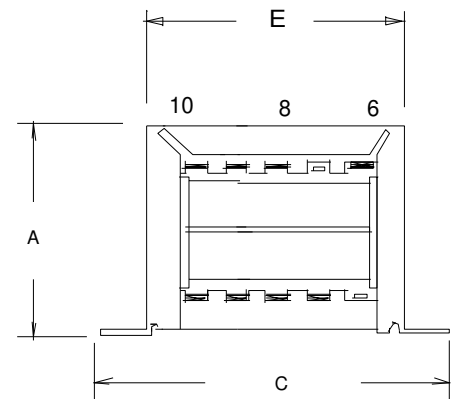
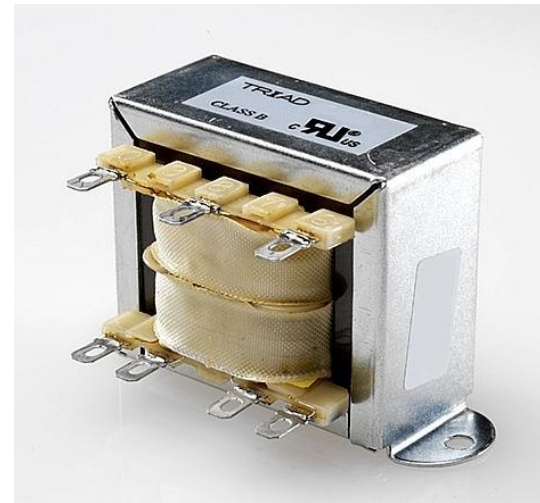

<sup>1</sup> Fuse must be used on **secondary** as conditions of acceptability for UL Class 2/3 operation