

# 150 mA low quiescent current low noise voltage regulator

Datasheet - production data

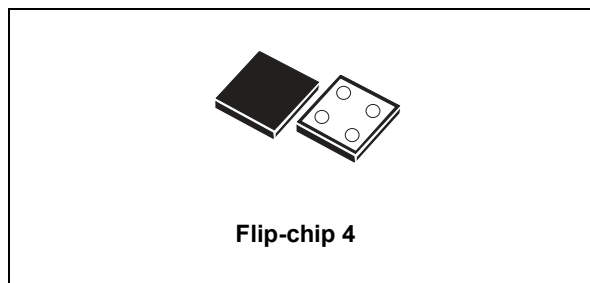

- Flip-chip 4 bumps 0.8 x 0.8 mm. pitch 0.4 mm
- Temperature range: -40 °C to 125 °C

## Applications

- Mobile phones
- Personal digital assistants (PDAs)
- Cordless phones and similar battery-powered systems

## Features

- Input voltage from 1.5 to 5.5 V
- Ultra low dropout voltage (80 mV typ. at 100 mA load)
- Very low quiescent current (20  $\mu$ A typ. at no load, 35  $\mu$ A typ. at 150 mA load, 1  $\mu$ A max in off mode)
- Very low noise (33  $\mu$ V<sub>RMS</sub> from 1 kHz to 100 kHz at  $V_{OUT} = 1.8$  V)
- Output voltage tolerance:  $\pm 2.0$  % @ 25 °C
- 150 mA guaranteed output current
- Wide range of output voltages available on request: 0.8 V to 4.5 V with 100 mV step
- Logic-controlled electronic shutdown
- Compatible with ceramic capacitor  $C_{OUT} = 1$   $\mu$ F
- Internal current and thermal limit

## Description

The LD39115J provides 150 mA maximum current from an input voltage ranging from 1.5 V to 5.5 V with a typical dropout voltage of 80 mV. It is stabilized with a ceramic capacitor. The ultra low drop voltage, low quiescent current and low noise features make it suitable for low power battery-powered applications. Power supply rejection is 65 dB at low frequencies and starts to roll off at 10 kHz. An enable logic control function puts the LD39115J in shutdown mode allowing a total current consumption lower than 1  $\mu$ A. The device also includes a short-circuit constant current limiting and thermal protection.

**Table 1. Device summary**

Order codes	Output voltages
LD39115J12R	1.2 V
LD39115J14R	1.4 V
LD39115J15R	1.5 V
LD39115J18R	1.8 V
LD39115J25R	2.5 V
LD39115J28R	2.8 V
LD39115J30R	3.0 V
LD39115J33R	3.3 V

# Contents

1	Diagram .....	3
2	Pin configuration .....	4
3	Typical application .....	5
4	Maximum ratings .....	6
5	Electrical characteristics .....	7
6	Typical performance characteristics .....	9
7	Package mechanical data .....	15
8	Packaging mechanical data .....	17
9	Different output voltage versions of the LD39115J available on request .....	19
10	Revision history .....	20

# 1 Diagram

Figure 1. Block diagram

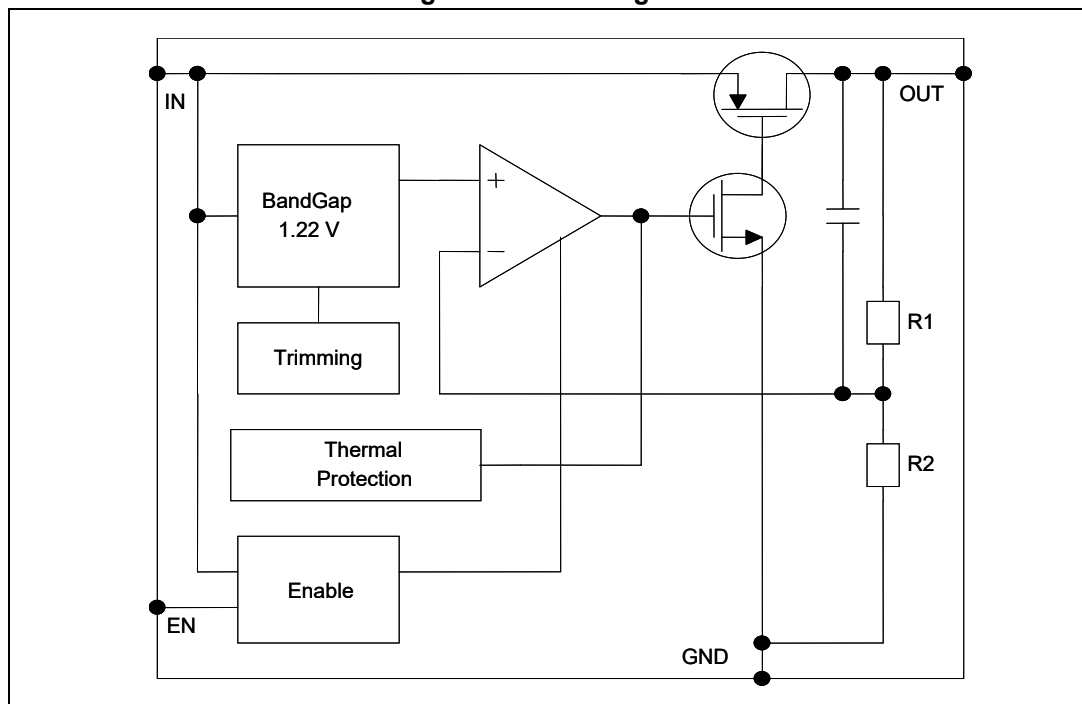

## 2 Pin configuration

Figure 2. Pin connection (top view)

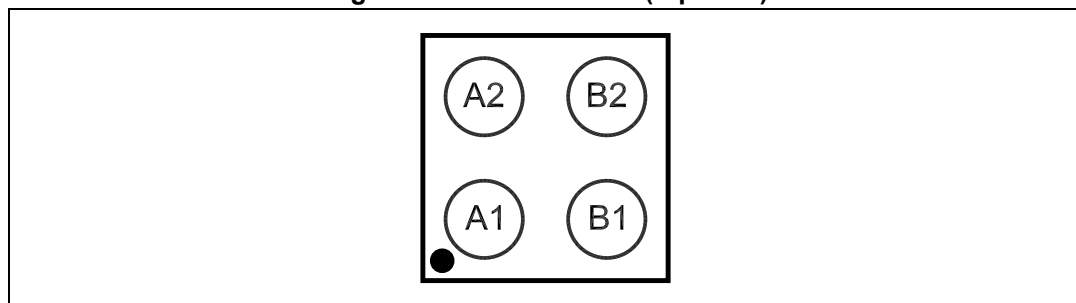
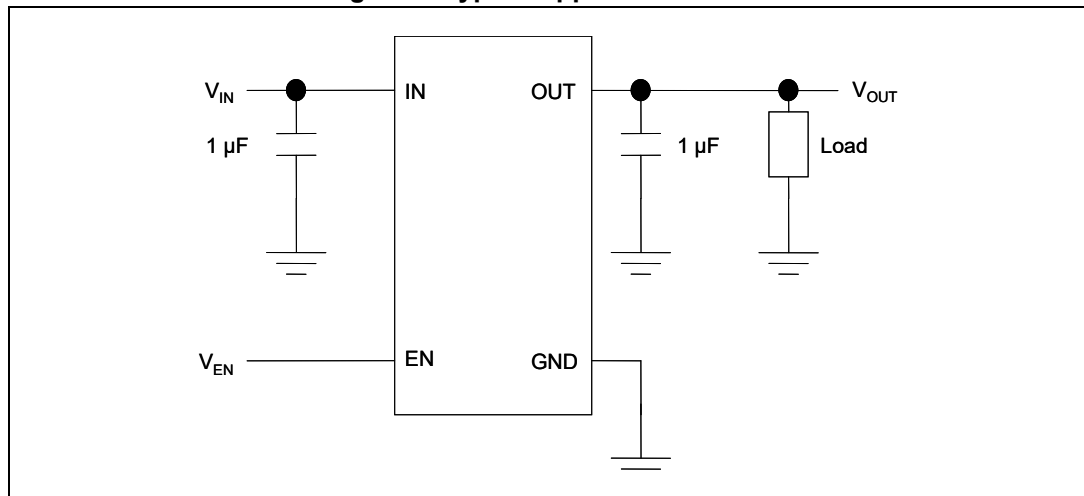

Table 2. Pin description

Pin n°	Symbol	Function
A2	EN	Enable pin logic input: Low = shutdown, High = active
A1	GND	Common ground
B2	IN	Input voltage of the LDO
B1	OUT	Output voltage

### 3 Typical application

Figure 3. Typical application circuit



## 4 Maximum ratings

**Table 3. Absolute maximum ratings**

Symbol	Parameter	Value	Unit
$V_{IN}$	DC input voltage	- 0.3 to 6	V
$V_{OUT}$	DC output voltage	- 0.3 to $V_I + 0.3$	V
$V_{EN}$	Enable input voltage	- 0.3 to $V_I + 0.3$	V
$I_{OUT}$	Output current	Internally limited	mA
$P_D$	Power dissipation	Internally limited	mW
$T_{STG}$	Storage temperature range	- 65 to 150	°C
$T_{OP}$	Operating junction temperature range	- 40 to 125	°C

*Note:* Absolute maximum ratings are those values beyond which damage to the device may occur. Functional operation under these conditions is not implied. All values are referred to GND.

**Table 4. Thermal data**

Symbol	Parameter	Value	Unit
$R_{thJA}$	Thermal resistance junction-ambient	180	°C/W

**Table 5. ESD performance**

Symbol	Parameter	Test conditions	Value	Unit
ESD	ESD protection voltage	HBM	4	kV

## 5 Electrical characteristics

$T_J = 25\text{ °C}$ ,  $V_{IN} = V_{OUT(NOM)} + 1\text{ V}$ ,  $C_{IN} = C_{OUT} = 1\text{ }\mu\text{F}$ ,  $I_{OUT} = 1\text{ mA}$ ,  $V_{EN} = V_{IN}$ , unless otherwise specified.

**Table 6. Electrical characteristics for LD39115J (1)**

Symbol	Parameter	Test conditions	Min.	Typ.	Max.	Unit
$V_{IN}$	Operating input voltage		1.5		5.5	V
$V_{UVLO}$	Turn-on threshold			1.45	1.48	V
	Turn-off threshold		1.30	1.35		mV
$V_{OUT}$	$V_{OUT}$ accuracy	$V_{OUT} > 1.5\text{ V}$ , $I_{OUT} = 1\text{ mA}$ , $T_J = 25\text{ °C}$	-2.0		2.0	%
		$V_{OUT} > 1.5\text{ V}$ , $I_{OUT} = 1\text{ mA}$ , $-40\text{ °C} < T_J < 125\text{ °C}$	-3.0		3.0	%
		$V_{OUT} \leq 1.5\text{ V}$ , $I_{OUT} = 1\text{ mA}$		$\pm 10$		mV
		$V_{OUT} \leq 1.5\text{ V}$ , $I_{OUT} = 1\text{ mA}$ , $-40\text{ °C} < T_J < 125\text{ °C}$		$\pm 30$		mV
$\Delta V_{OUT}$	Static line regulation	$V_{OUT} + 1\text{ V} \leq V_{IN} \leq 5.5\text{ V}$ , $I_{OUT} = 1\text{ mA}$		0.01		%/V
$\Delta V_{OUT}$	Transient line regulation (2)	$\Delta V_{IN} = +500\text{ mV}$ , $I_{OUT} = 1\text{ mA}$ , $T_R = T_F = 5\text{ }\mu\text{s}$		10		mVpp
$\Delta V_{OUT}$	Static load regulation	$I_{OUT} = 1\text{ mA to } 150\text{ mA}$		0.002		%/mA
$\Delta V_{OUT}$	Transient load regulation (2)	$I_{OUT} = 1\text{ mA to } 150\text{ mA}$ , $t_R = t_F = 5\text{ }\mu\text{s}$		40		mVpp
$V_{DROPP}$	Dropout voltage (3)	$I_{OUT} = 100\text{ mA}$ , $V_{OUT} > 1.5\text{ V}$ , $-40\text{ °C} < T_J < 125\text{ °C}$		80	110	mV
$e_N$	Output noise voltage	10 Hz to 100 kHz, $I_{OUT} = 10\text{ mA}$		30		$\mu\text{V}_{RMS}/\text{V}$
SVR	Supply voltage rejection $V_{OUT} = 1.5\text{ V}$	$V_{IN} = V_{OUT(NOM)} + 1\text{ V} \pm V_{RIPPLE}$ $V_{RIPPLE} = 0.1\text{ V}$ Freq. = 1 kHz $I_{OUT} = 10\text{ mA}$		74		dB
		$V_{IN} = V_{OUT(NOM)} + 0.5\text{ V} \pm V_{RIPPLE}$ $V_{RIPPLE} = 0.1\text{ V}$ Freq. = 10 kHz $I_{OUT} = 10\text{ mA}$		67		
$I_Q$	Quiescent current	$I_{OUT} = 0\text{ mA}$		20		$\mu\text{A}$
		$I_{OUT} = 0\text{ mA}$ , $-40\text{ °C} < T_J < 125\text{ °C}$			50	
		$I_{OUT} = 0\text{ to } 150\text{ mA}$		35		
		$I_{OUT} = 0\text{ to } 150\text{ mA}$ , $-40\text{ °C} < T_J < 125\text{ °C}$			70	
		$V_{IN}$ input current in OFF MODE: $V_{EN} = \text{GND}$		0.001	1	

Table 6. Electrical characteristics for LD39115J (continued)<sup>(1)</sup>

Symbol	Parameter	Test conditions	Min.	Typ.	Max.	Unit
I <sub>SC</sub>	Short circuit current	R <sub>L</sub> = 0	200			mA
V <sub>EN</sub>	Enable input logic low	V <sub>IN</sub> = 1.5 V to 5.5 V, -40 °C < T <sub>J</sub> < 125 °C			0.4	V
	Enable input logic high	V <sub>IN</sub> = 1.5 V to 5.5 V, -40 °C < T <sub>J</sub> < 125 °C	0.9			
I <sub>EN</sub>	Enable pin input current	V <sub>SHDN</sub> = V <sub>IN</sub>		0.1	100	nA
T <sub>ON</sub>	Turn on time <sup>(4)</sup>			30		μs
T <sub>SHDN</sub>	Thermal shutdown			160		°C
	Hysteresis			20		
C <sub>OUT</sub>	Output capacitor	Capacitance (see <a href="#">Section 6: Typical performance characteristics</a> )	1		22	μF

1. For V<sub>OUT(NOM)</sub> < 1.2 V, V<sub>IN</sub> = 1.5 V.
2. All transient values are guaranteed by design, not production tested.
3. Dropout voltage is the input-to-output voltage difference at which the output voltage is 100 mV below its nominal value. This specification does not apply for output voltages below 1.5 V.
4. Turn-on time is time measured between the enable input just exceeding V<sub>EN</sub> high value and the output voltage just reaching 95 % of its nominal value.



## 6 Typical performance characteristics

$C_{IN} = C_{OUT} = 1 \mu\text{F}$ ,  $V_{EN}$  to  $V_{IN}$ .

**Figure 4. Output voltage vs. temperature**  
( $V_{OUT} = 1.2 \text{ V}$ )

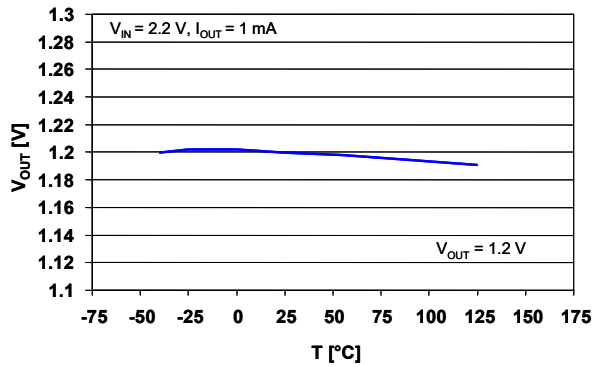

**Figure 5. Output voltage vs. temperature**  
( $V_{OUT} = 2.8 \text{ V}$ )

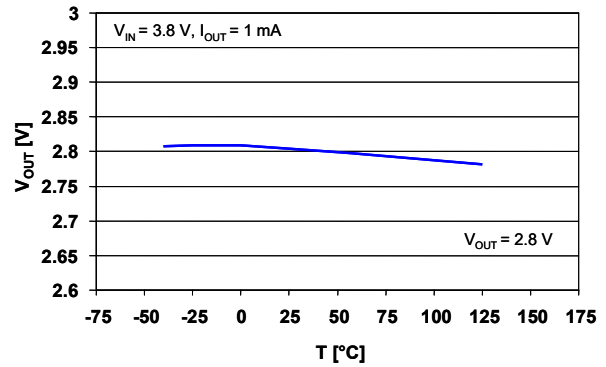

**Figure 6. Line regulation vs. temperature**

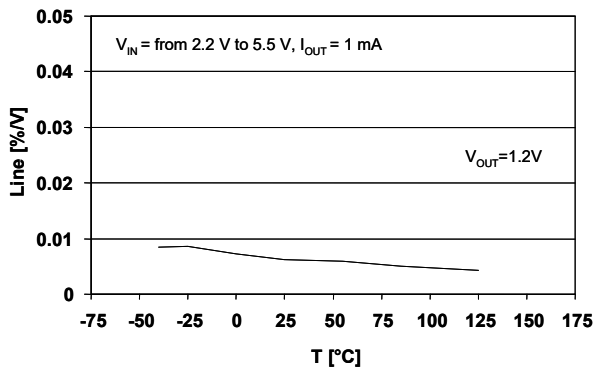

**Figure 7. Load regulation vs. temperature**

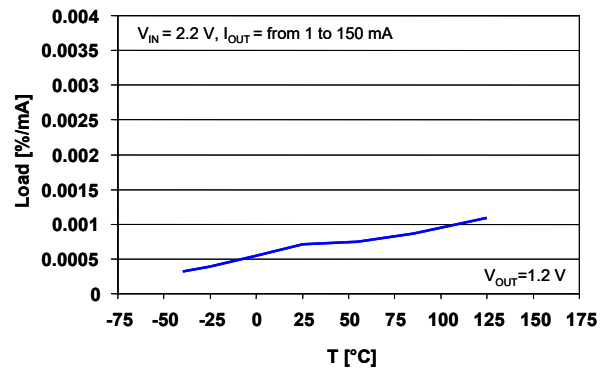

Figure 8. Short-circuit current vs. drop voltage

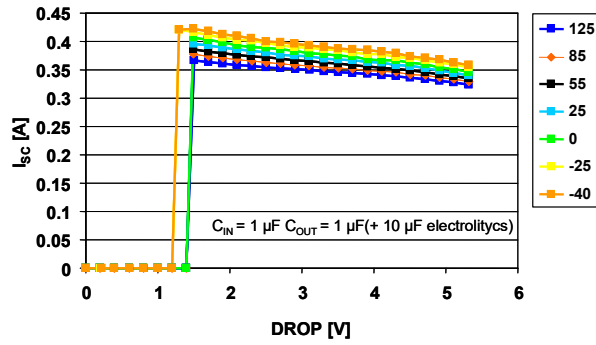

Figure 9. Dropout voltage vs. temperature

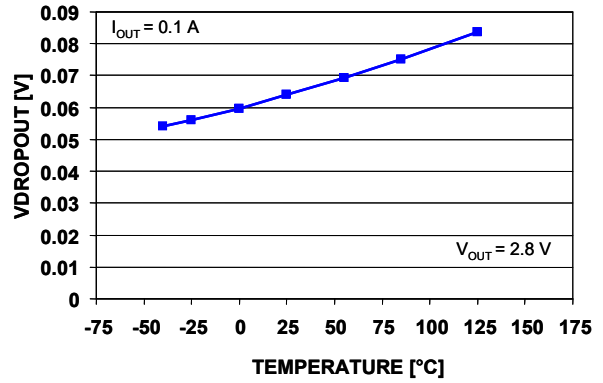

Figure 10. Dropout voltage vs. output current

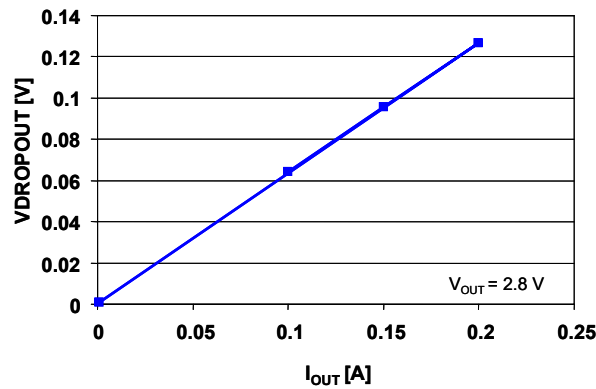

Figure 11. Output voltage vs. input voltage ( $V_{OUT} = 1.3 V$ )

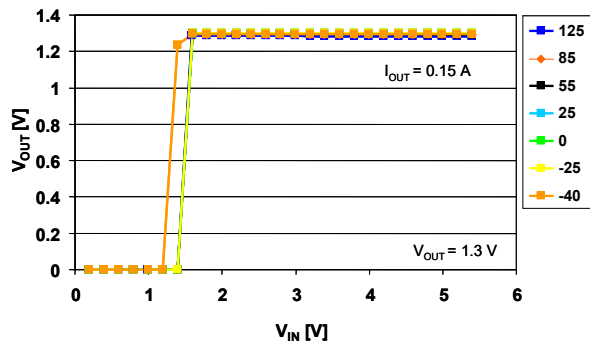

Figure 12. Output voltage vs. input voltage ( $V_{OUT} = 2.8 V$ )

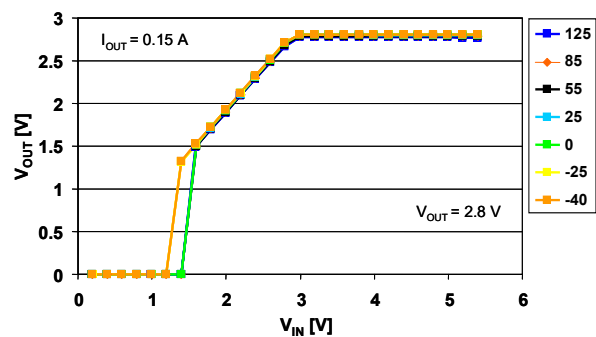
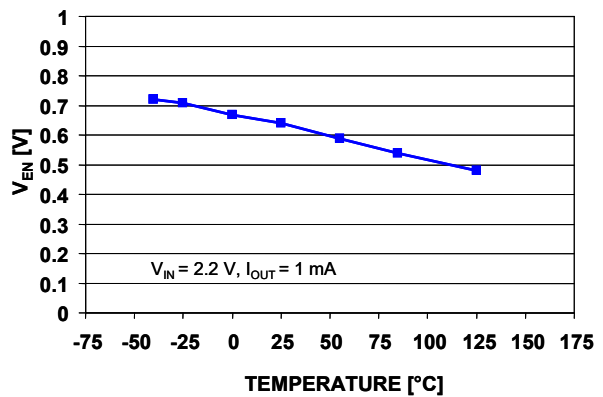
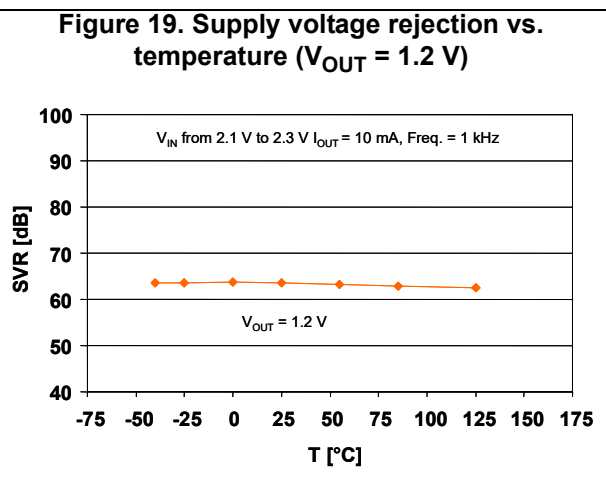
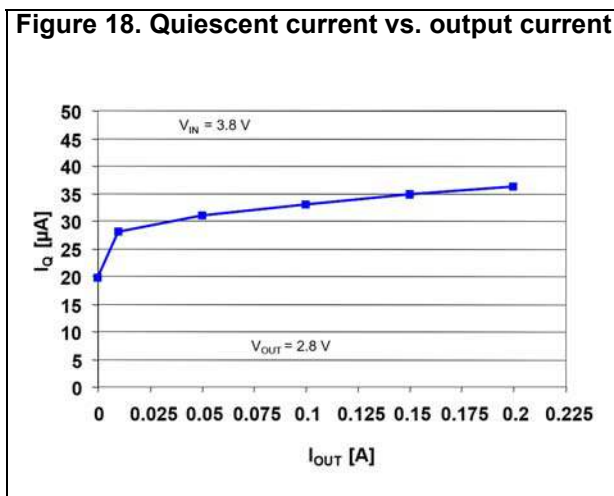
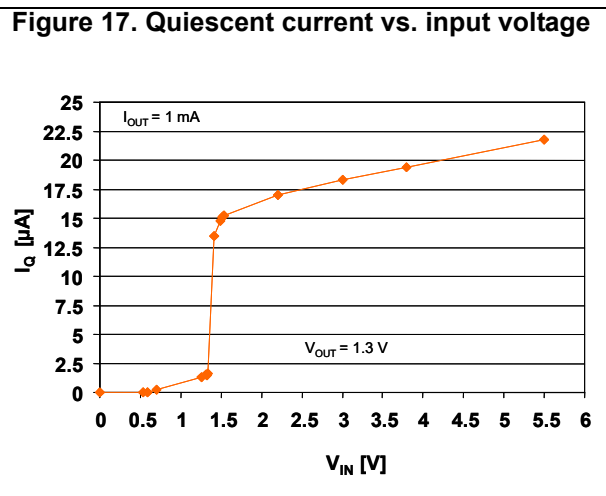
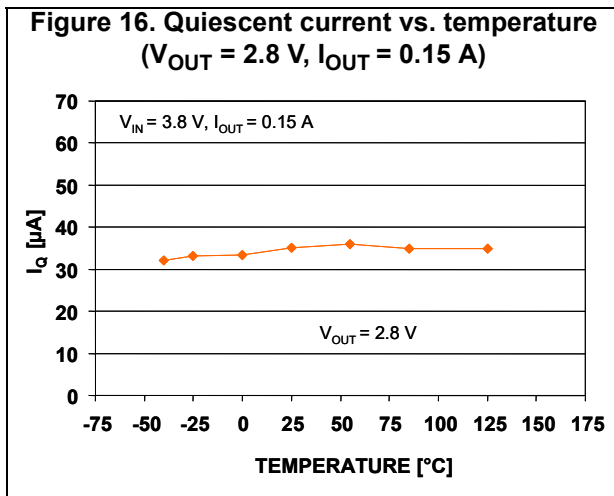
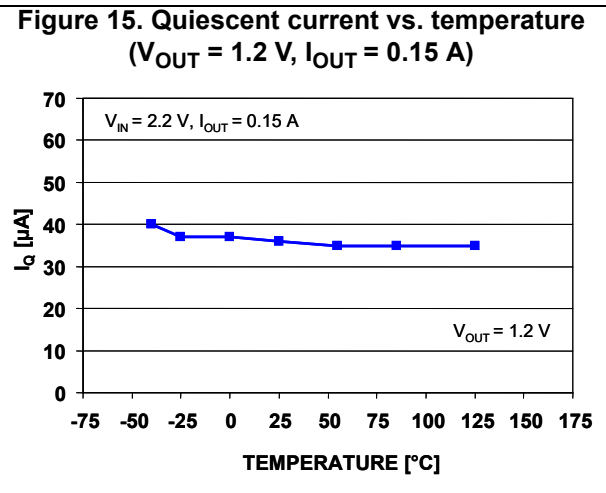
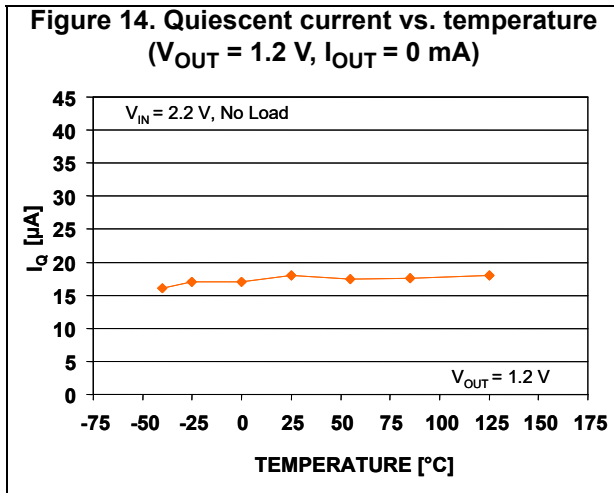
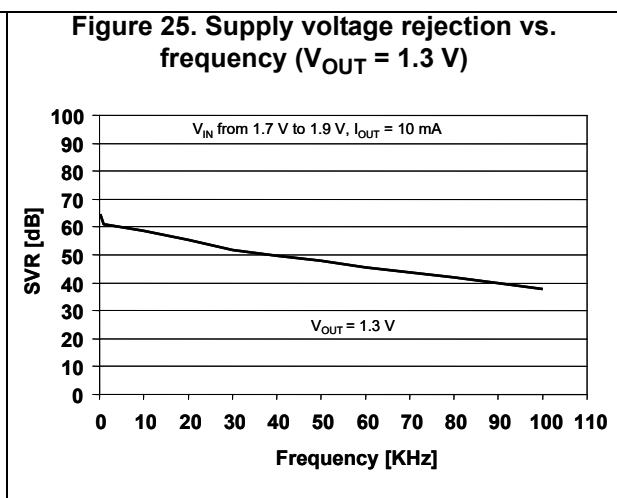
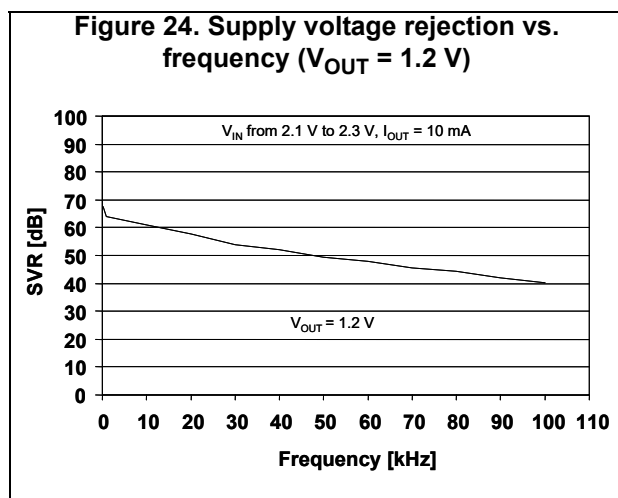
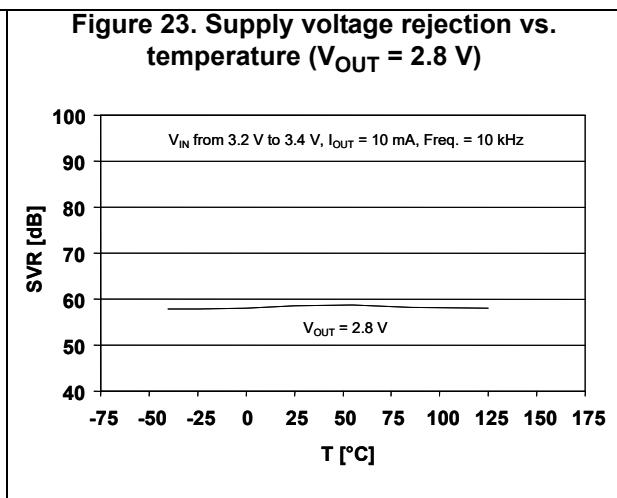
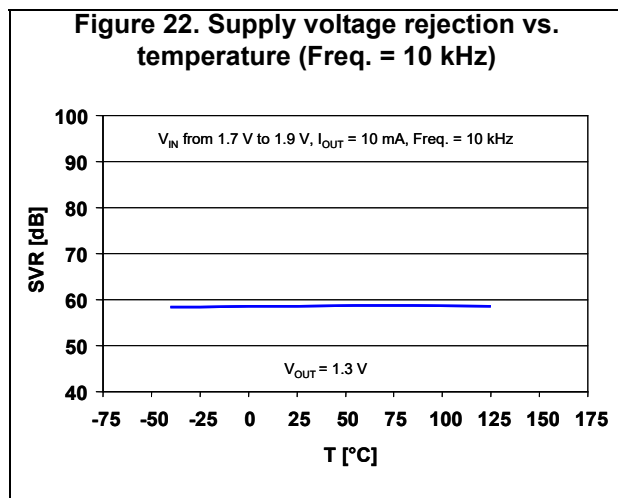
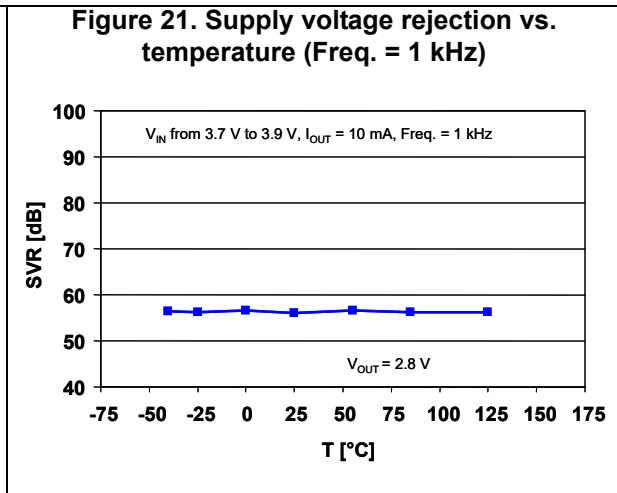
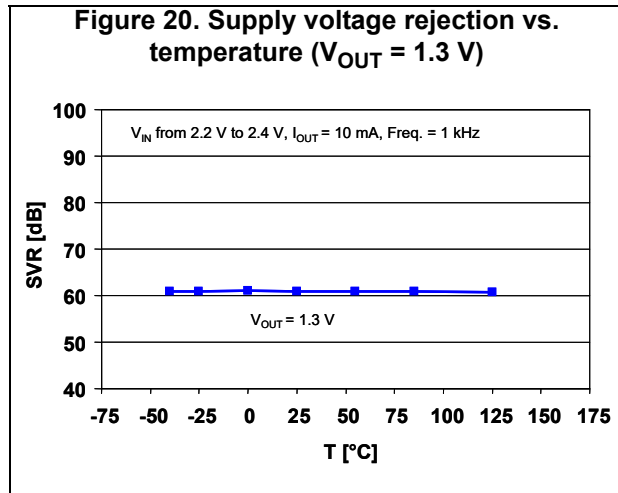

Figure 13. Enable threshold vs. temperature







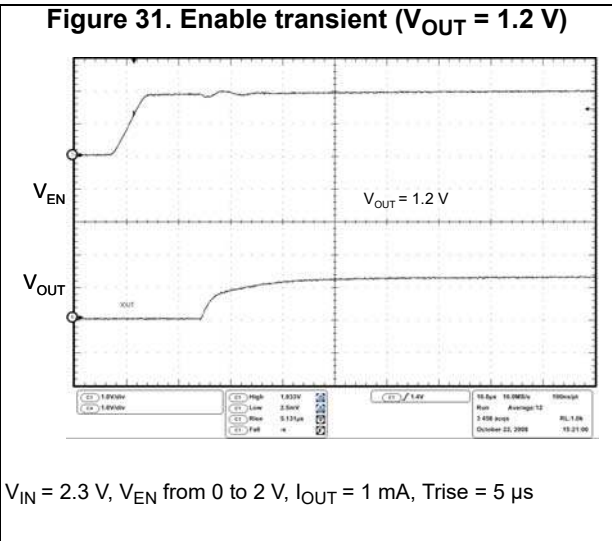
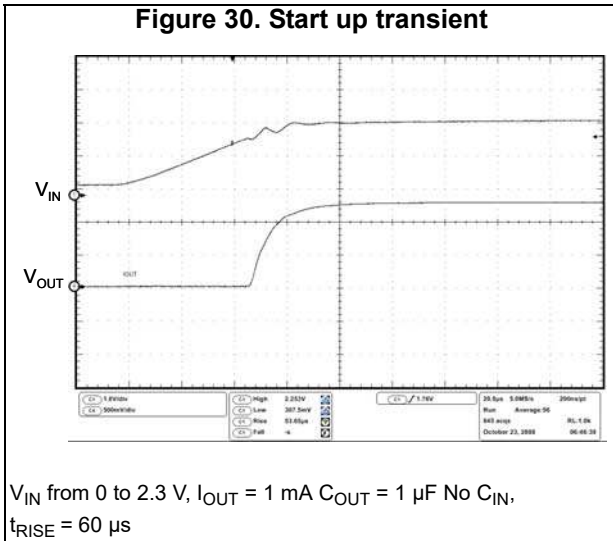
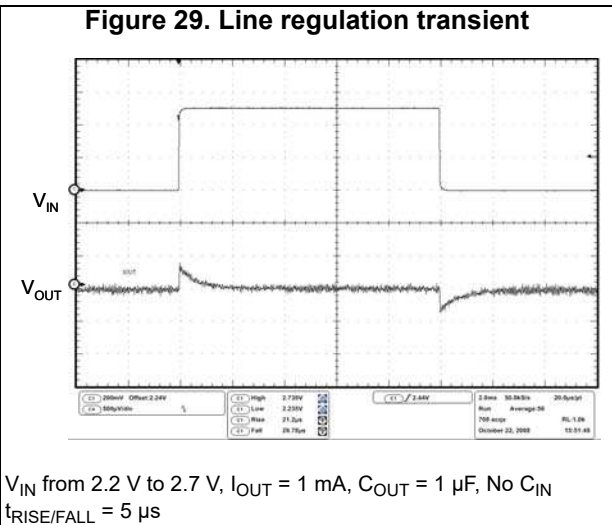
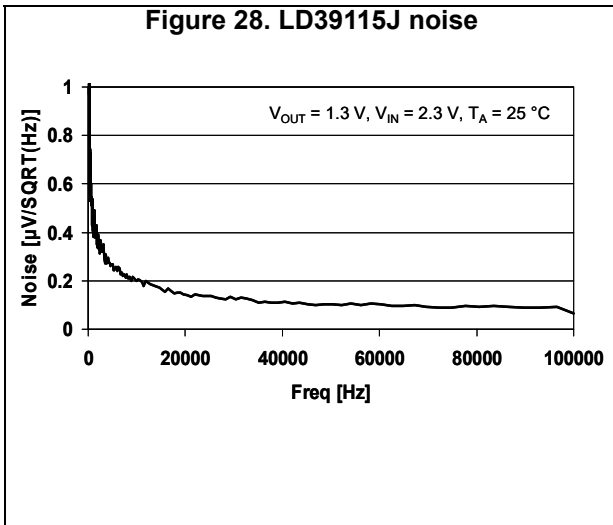
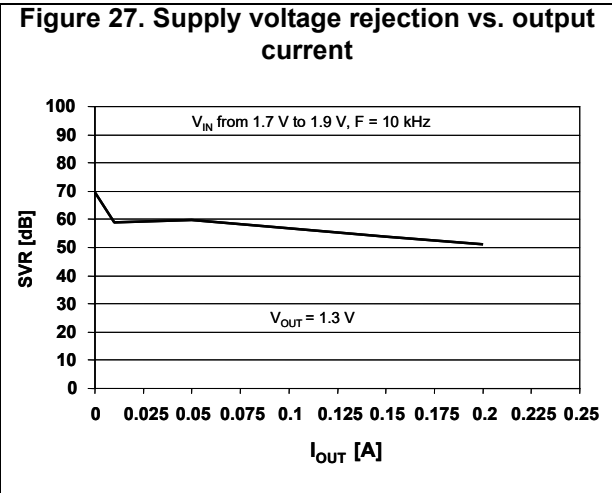
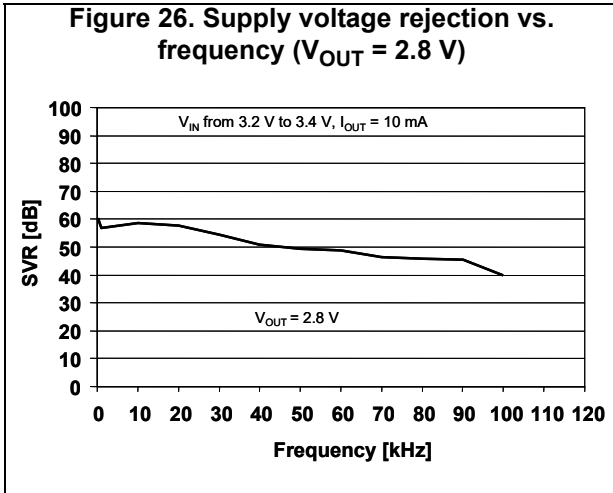
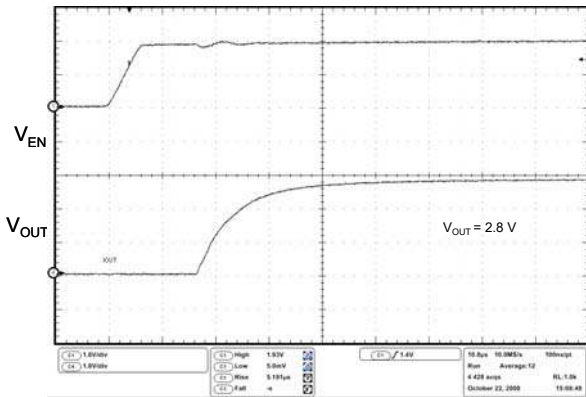
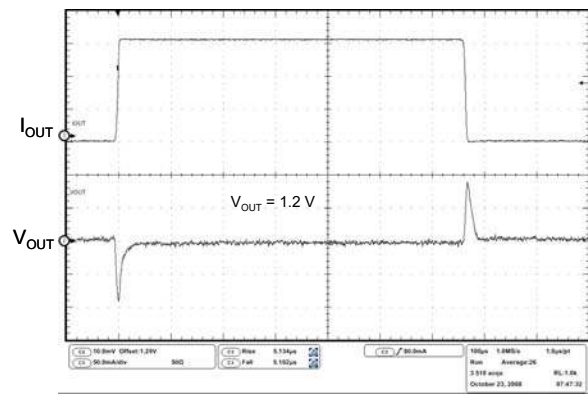

Figure 32. Enable transient ( $V_{OUT} = 2.8\text{ V}$ )



$V_{IN} = 3.8\text{ V}$ ,  $V_{EN}$  from 0 to 2 V,  $I_{OUT} = 1\text{ mA}$ ,  $t_{RISE} = 5\text{ }\mu\text{s}$

Figure 33. Load transient ( $V_{OUT} = 1.2\text{ V}$ )



$V_{IN} = 2.2\text{ V}$ ,  $I_{OUT}$  = from 1 to 150 mA,  $t_{RISE/FALL} = 5\text{ }\mu\text{s}$

Figure 34. Load transient ( $V_{OUT} = 2.8\text{ V}$ )

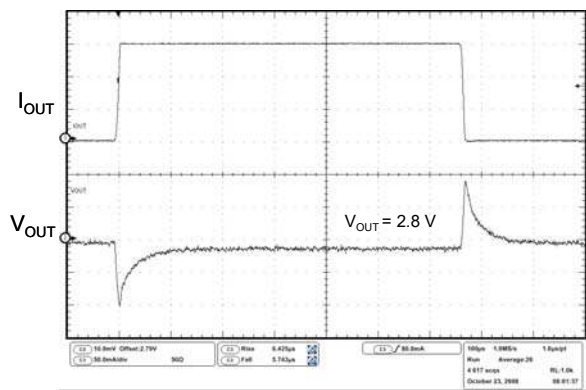

$V_{in} = 3.8\text{ V}$ ,  $I_{OUT}$  = from 1 to 150 mA,  $t_{RISE/FALL} = 5\text{ }\mu\text{s}$

Figure 35. ESR required for stability with ceramics capacitors

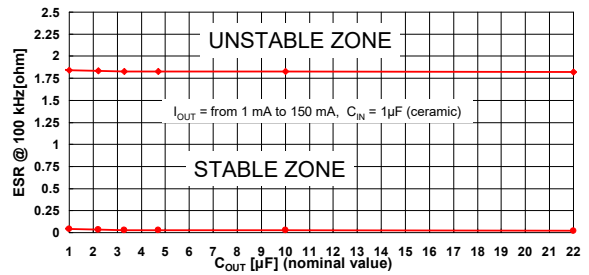

$V_{IN} = 2.2\text{ V}$ ,  $I_{OUT}$  = from 1 to 150 mA,  $t_{RISE/FALL} = 5\text{ }\mu\text{s}$

## 7 Package mechanical data

In order to meet environmental requirements, ST offers these devices in different grades of ECOPACK packages, depending on their level of environmental compliance. ECOPACK specifications, grade definitions and product status are available at: [www.st.com](http://www.st.com). ECOPACK is an ST trademark.

Figure 36. Flip-chip 4 drawings

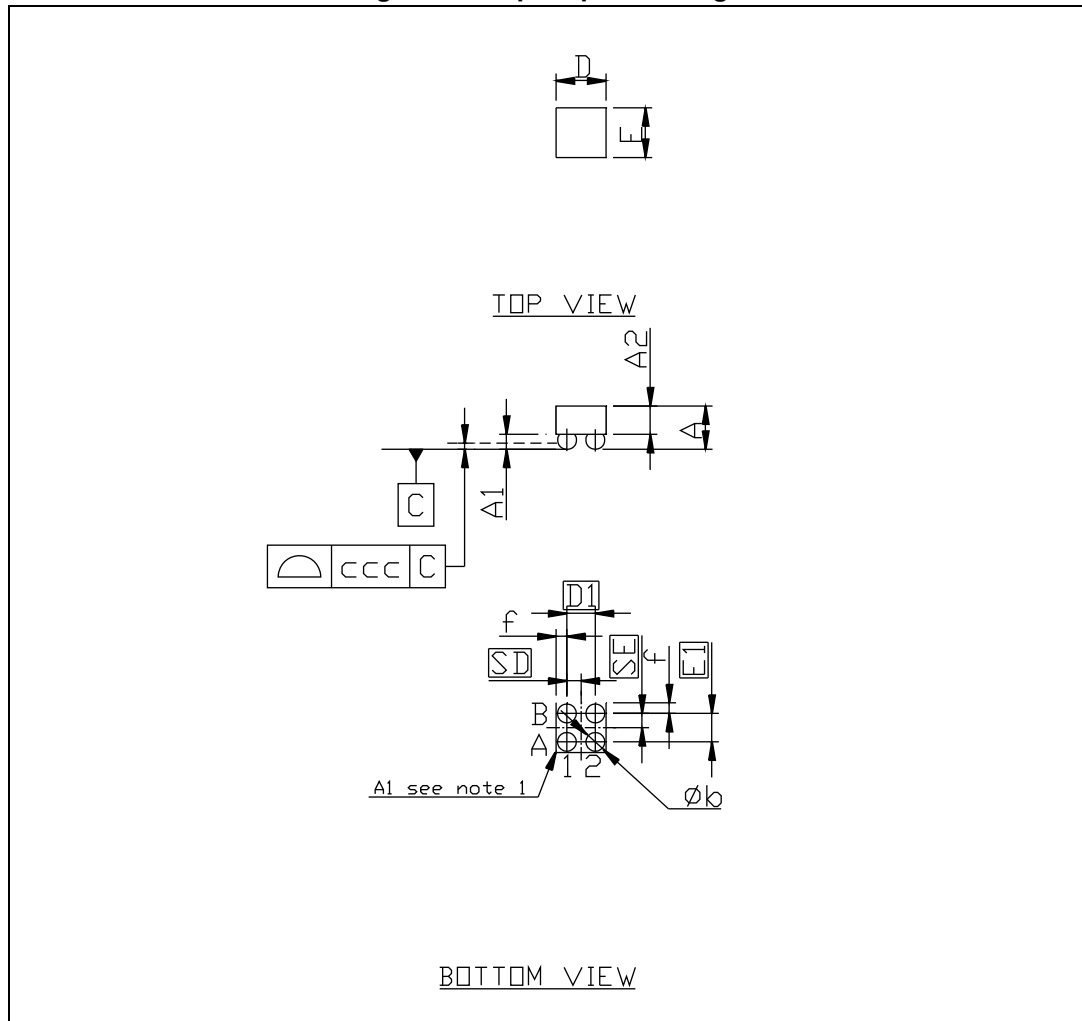
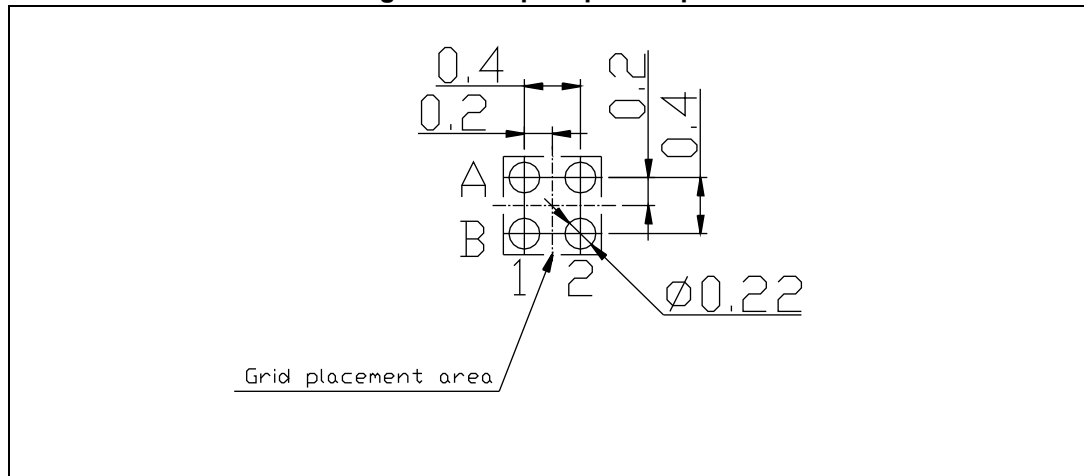

Table 7. Flip-chip 4 mechanical data

Dim.	mm		
	Min.	Typ.	Max.
A	0.52	0.56	0.60
A1	0.17	0.20	0.23
A2	0.35	0.36	0.37
b	0.23	0.25	0.29
D	0.758	0.788	0.818
D1		0.4	
E	0.758	0.788	0.818
E1		0.4	
SD	0.18	0.2	0.22
SE	0.18	0.2	0.22
f		0.199	
ccc		0.075	

Figure 37. Flip-chip 4 footprint





# 8 Packaging mechanical data

Figure 38. Flip-chip 4 tape and reel drawing

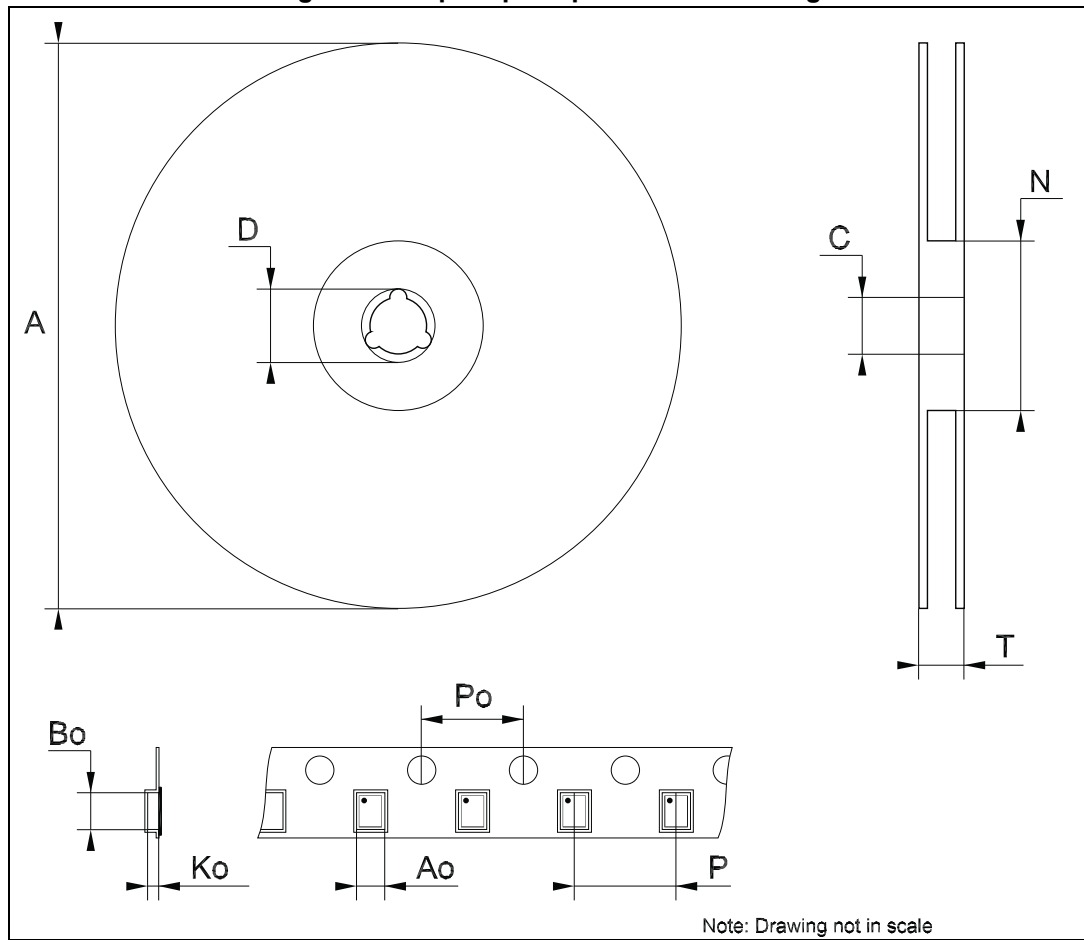

Table 8. Flip-chip 4 tape and reel mechanical data

Dim.	mm		
	Min.	Typ.	Max.
A			178
C	12.8		13.2
D	20.2		
N	59	60	61
T			8.4
Ao	0.82	0.87	0.92
Bo	0.82	0.87	0.92
Ko	0.64	0.69	0.74
Po	3.9	4.0	4.1
P	3.9	4.0	4.1

## 9 Different output voltage versions of the LD39115J available on request

Table 9. Options available on request

Order codes	Output voltages
LD39115J08R	0.8 V
LD39115J10R	1.0 V

## 10 Revision history

**Table 10. Document revision history**

Date	Revision	Changes
26-Mar-2009	1	Initial release.
12-Jun-2009	2	Modified: Table 1 on page 1 and Table 8 on page 19.
05-Aug-2009	3	Modified: tape and reel mechanical data on page 18.
17-May-2011	4	Modified: Table 1 on page 1 and Table 8 on page 19.
20-Dec-2011	5	Added: new order code LD39115J25R Table 1 on page 1.
16-Jan-2014	6	Part number LD39115Jxx changed to LD39115J. Updated the Description in cover page, Section 7: Package mechanical data. Added Section 8: Packaging mechanical data. Minor text changes.
12-Sep-2018	7	Added Table 5: ESD performance.
23-Feb-2021	8	Updated <a href="#">Figure 18</a> and <a href="#">Figure 28</a> .

**IMPORTANT NOTICE – PLEASE READ CAREFULLY**

STMicroelectronics NV and its subsidiaries (“ST”) reserve the right to make changes, corrections, enhancements, modifications, and improvements to ST products and/or to this document at any time without notice. Purchasers should obtain the latest relevant information on ST products before placing orders. ST products are sold pursuant to ST’s terms and conditions of sale in place at the time of order acknowledgement.

Purchasers are solely responsible for the choice, selection, and use of ST products and ST assumes no liability for application assistance or the design of Purchasers’ products.

No license, express or implied, to any intellectual property right is granted by ST herein.

Resale of ST products with provisions different from the information set forth herein shall void any warranty granted by ST for such product.

ST and the ST logo are trademarks of ST. For additional information about ST trademarks, please refer to [www.st.com/trademarks](http://www.st.com/trademarks). All other product or service names are the property of their respective owners.

Information in this document supersedes and replaces information previously supplied in any prior versions of this document.

© 2021 STMicroelectronics – All rights reserved