



Quartz Crystal Specification

IQD Part No. + Packaging: LFX TAL081612Reel

Würth Part No. 830108161201



Description

- Standard 1.6 x 1.2mm SMD crystal in a hermetically sealed ceramic package with a sealed metal lid
- Model IQXC-26
- Model Issue number 4

Frequency Parameters

- Frequency 30.0MHz
- Frequency Tolerance $\pm 10.00\text{ppm}$
- Tolerance Condition @ 25°C
- Frequency Stability $\pm 20.00\text{ppm}$
- Operating Temperature Range -40.00 to 85.00°C
- Overtone Order Fundamental
- Ageing $\pm 5\text{ppm}$ max per year @ 25°C

Electrical Parameters

- Load Capacitance (CL) 8.00pF
- Shunt Capacitance (C0) 7pF max
- Drive Level 100 μ W max
- ESR 200.00 Ω max

Environmental Parameters

- Storage Temperature Range: -40 to 85°C
- Shock: IEC 60068-2-27: 1000G, 1ms, 3 times in each of 3 mutually perpendicular planes
- Vibration: IEC 60068-2-6: 1.5mm amplitude, 10Hz-55Hz, 1min in 3 mutually perpendicular planes, duration 2hrs each plane (total 6hrs)

Compliance

- RoHS Status (2015/863/EU) Compliant
- REACH Status Compliant
- MSL Rating (JDEC-STD-033): Not Applicable

Packaging Details

- Pack Style: Reel Tape & reel in accordance with EIA-481-D
Pack Size: 3,000
- Alternative packing option available

USEFUL LINKS

Toolbox:

www.we-online.com/toolbox

Product Catalog:

www.we-online.com/products

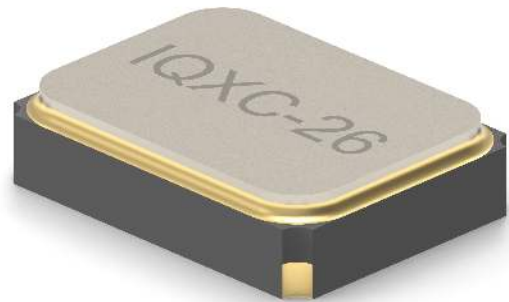

Outline (mm)

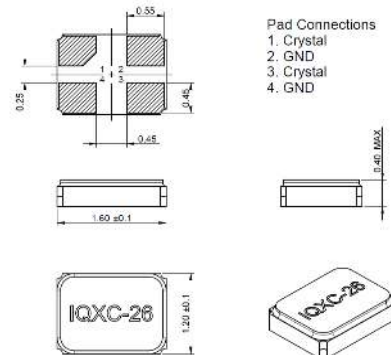

NOTE: The pad style on the base of the device may differ slightly from the drawing.
The chamfer may appear on pad 1 or 4.
This causes no change to the electrical performance of the device.

Recommended Solder Pad Layout

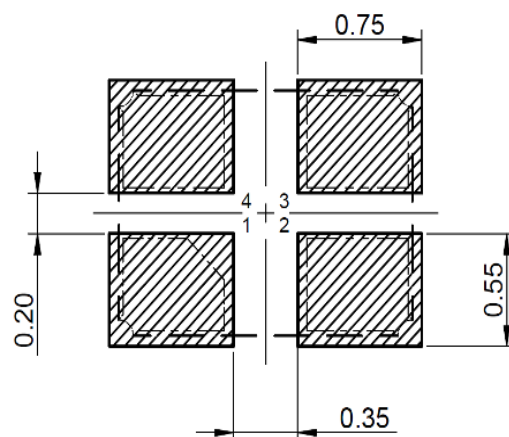

CONTACT INFORMATION:

Würth Elektronik eiSos GmbH & Co. KG
Max-Eyth-Str. 1, 74638 Waldenburg, Germany
Tel: +49(0) 7942 945-0

Email: eiSos@we-online.de
Web: www.we-online.com