

# GT Series Sealed Ultraminiature Toggle Switches

## Features/Benefits

- Sealed against solder and cleaning process contaminants
- Ultraminiature size, smallest footprint available
- Thru-hole and surface mount models
- High temperature materials (UL 94V-0)
- RoHS compliant and compatible

## Typical Applications

- Hand-held telecommunications
- Small instrumentation



## Specifications

CONTACT RATING: 0.4 VA max. @ 20 V AC or DC max.  
 MECHANICAL & ELECTRICAL LIFE: 40,000 make-and-break cycles at full load.  
 CONTACT RESISTANCE: Below 50 m Ω typ. initial @ 2-4 V DC, 100 mA.  
 INSULATION RESISTANCE: 10<sup>9</sup> Ω min.  
 DIELECTRIC STRENGTH: 500 Vrms min. @ sea level.  
 OPERATING TEMPERATURE: -30°C to 85°C.  
 SOLDERABILITY: Per MIL-STD-202F method 208D, or EIA RS-186E method 9 (1 hour steam aging).  
 PACKAGING: Surface mount switches shipped in anti-static tape and reel packaging per EIA 481-3, see page F-47 for drawings and reel information. Tape and cover strip are conductive for use near statically sensitive components, consult Customer Service Center.

## Materials

HOUSING AND BASE: Glass filled nylon 4/6, flame retardant, heat stabilized (UL 94V-0).  
 ACTUATOR: Glass filled nylon 4/6, flame retardant, heat stabilized (UL 94V-0), with standard internal o-ring seal.  
 SWITCH SUPPORT: Brass, tin plated.  
 MOVABLE CONTACTS: Copper alloy, with gold plate over nickel plate.  
 STATIONARY CONTACTS: Copper alloy, with gold plate over nickel plate.  
 TERMINALS: Gold.  
 TERMINAL SEAL: Epoxy. All terminals insert molded.

**NOTE:** Specifications and materials listed above are for switches with standard options. For information on specific and custom switches, consult Customer Service Center.

## How To Order

Our easy build-a-switch concept allows you to mix and match options to create the switch you need. To order, select desired option from each category and place it in the appropriate box.

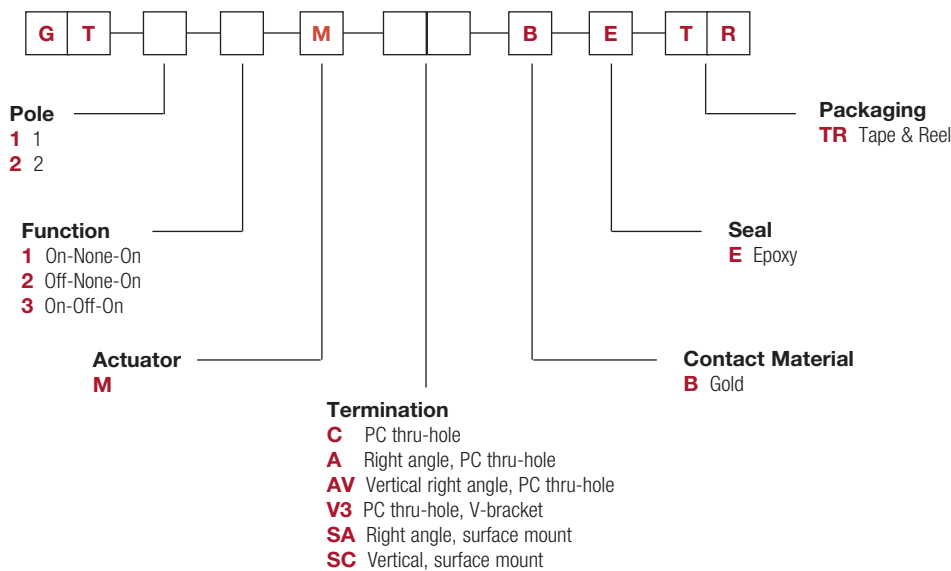

# GT Series Sealed Ultraminiature Toggle Switches

Complete part numbers for GT Series Sealed Ultraminiature Toggle Switches are shown on following pages.



GT11MCBE  
SPDT

PART NUMBER	SWITCH FUNCTION		
	POS.1	POS. 2	POS. 3
<b>GT11MCBE</b>	ON	NONE	ON
<b>GT13MCBE</b>	ON	OFF	ON
Conn. Terms.	2-3	OPEN	2-1
Schematic 			
SPDT Note: Pins 4 and 6 not connected			
<b>GT12MCBE</b>	OFF	NONE	ON
Conn. Terms.	OPEN	N/A	3-1
Schematic 			
SPST Note: Pins 4 and 6 not connected			

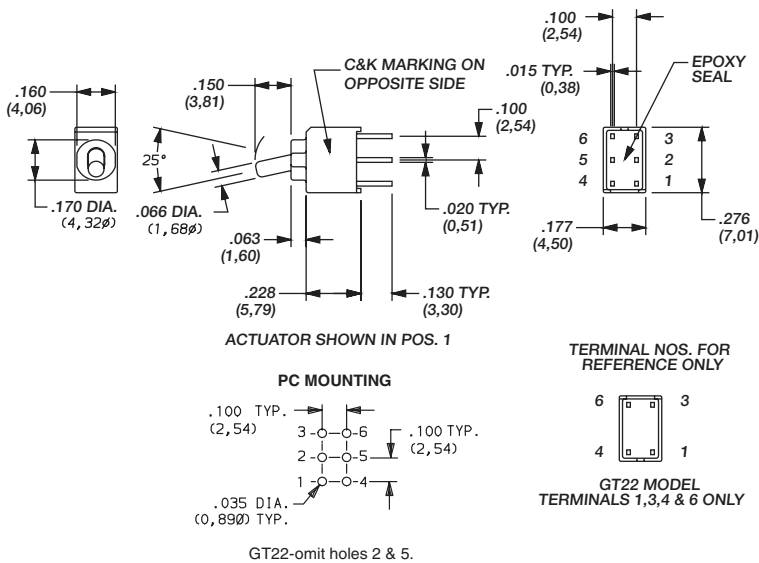
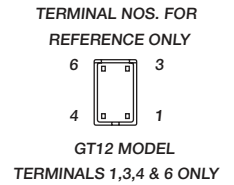
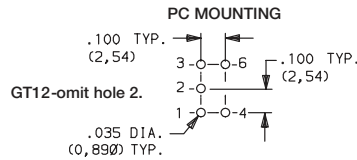
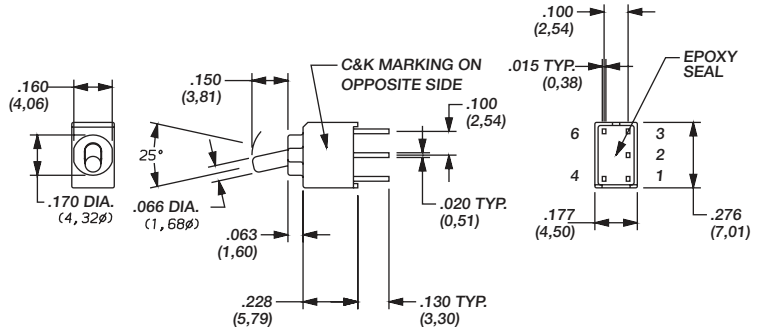

PART NUMBER	SWITCH FUNCTION		
	POS.1	POS. 2	POS. 3
<b>GT21MCBE</b>	ON	NONE	ON
<b>GT23MCBE</b>	ON	OFF	ON
Conn. Terms.	2-3, 5-6	OPEN	2-1, 5-4
Schematic 			
DPDT			
<b>GT22MCBE</b>	OFF	NONE	ON
Conn. Terms.	OPEN	N/A	3-1, 6-4
Schematic 			
DPST			



GT21MCBE  
DPDT

# GT Series Sealed Ultraminiature Toggle Switches

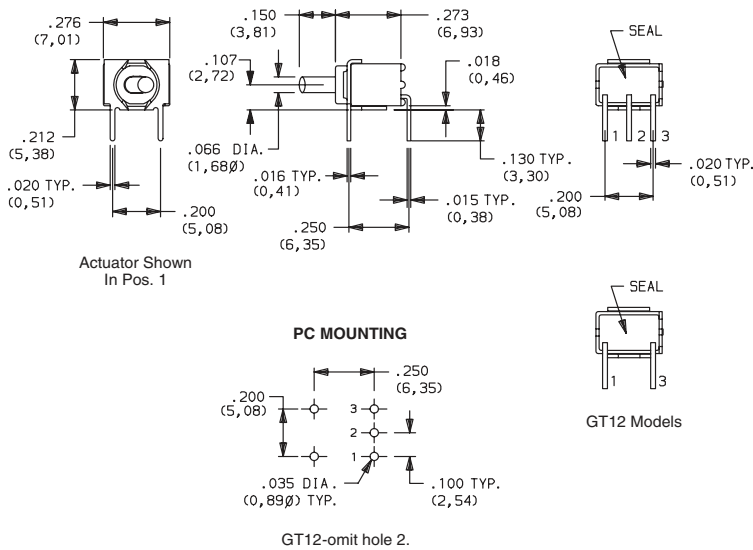

PART NUMBER	SWITCH FUNCTION		
	POS.1	POS. 2	POS. 3
<b>GT11MABE</b>	ON	NONE	ON
<b>GT13MABE</b>	ON	OFF	ON
Conn. Terms.	2-3	OPEN	2-1
Schematic			
SPDT			
<b>GT12MABE</b>	OFF	NONE	ON
Conn. Terms.	OPEN	N/A	3-1
Schematic			
SPST			



**GT11MABE**  
Horizontal  
Actuation  
**SPDT**

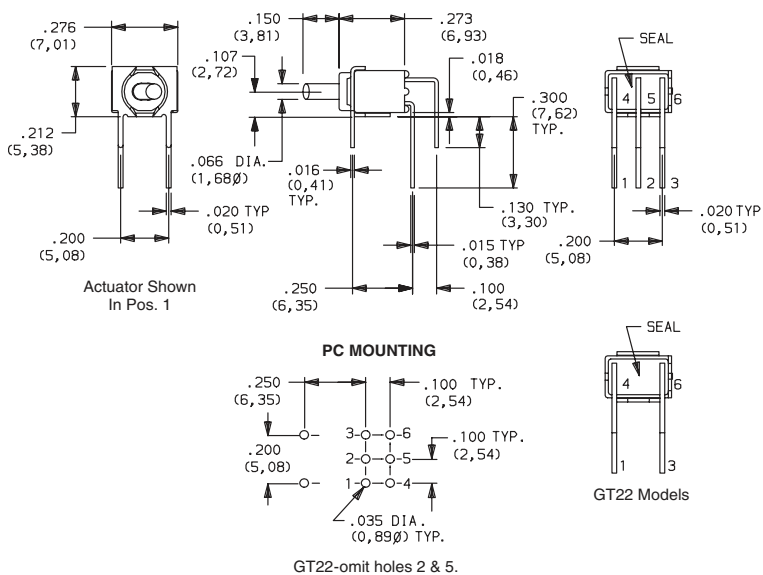

PART NUMBER	SWITCH FUNCTION		
	POS.1	POS. 2	POS. 3
<b>GT21MABE</b>	ON	NONE	ON
<b>GT23MABE</b>	ON	OFF	ON
Conn. Terms.	2-3, 5-6	OPEN	2-1, 5-4
Schematic			
DPDT			
<b>GT22MABE</b>	OFF	NONE	ON
Conn. Terms.	OPEN	N/A	3-1, 6-4
Schematic			
DPST			



**GT21MABE**  
Horizontal  
Actuation  
**DPDT**



T

Toggle

# GT Series Sealed Ultraminiature Toggle Switches



GT11MAVBE  
Vertical  
Actuation  
SPDT

PART NUMBER	SWITCH FUNCTION		
	POS. 1	POS. 2	POS. 3
<b>GT11MAVBE</b>	ON	NONE	ON
<b>GT13MAVBE</b>	ON	OFF	ON
Conn. Terms.	2-3	OPEN	2-1
Schematic			
SPDT			
<b>GT12MAVBE</b>	OFF	NONE	ON
Conn. Terms.	OPEN	N/A	3-1
Schematic			
SPST			

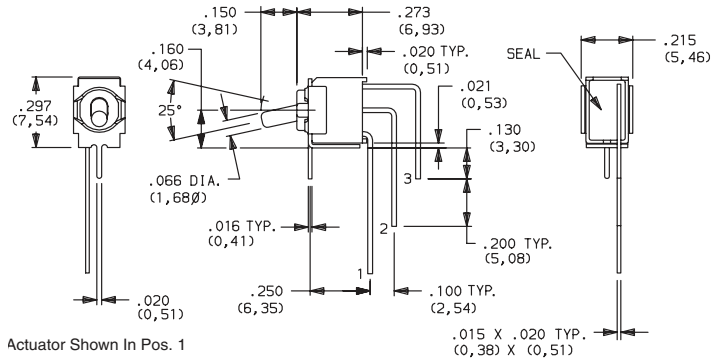

Actuator Shown In Pos. 1

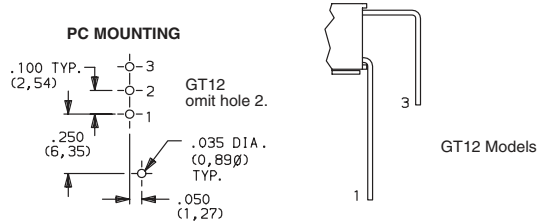

GT21MAVBE  
Vertical  
Actuation  
DPDT

PART NUMBER	SWITCH FUNCTION		
	POS. 1	POS. 2	POS. 3
<b>GT21MAVBE</b>	ON	NONE	ON
<b>GT23MAVBE</b>	ON	OFF	ON
Conn. Terms.	2-3, 5-6	OPEN	2-1, 5-4
Schematic			
DPDT			
<b>GT22MAVBE</b>	OFF	NONE	ON
Conn. Terms.	OPEN	N/A	3-1, 6-4
Schematic			
DPST			

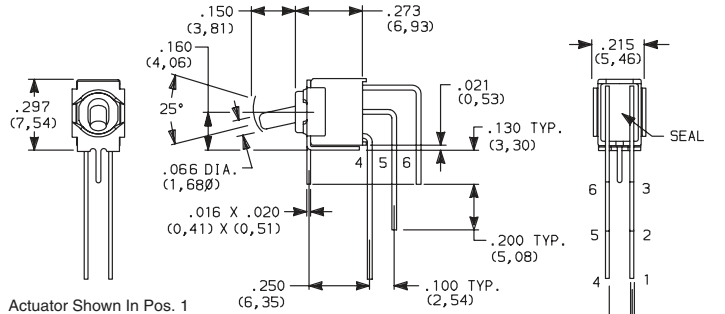

Actuator Shown In Pos. 1

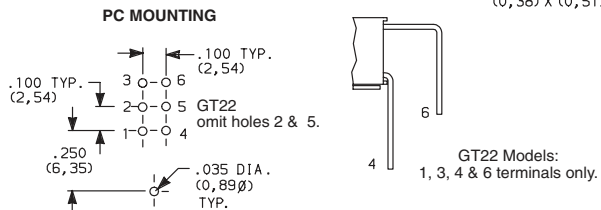

GT11MV3BE  
SPDT

PART NUMBER	SWITCH FUNCTION		
	POS. 1	POS. 2	POS. 3
<b>GT11MV3BE</b>	ON	NONE	ON
<b>GT13MV3BE</b>	ON	OFF	ON
Conn. Terms.	2-3	OPEN	2-1
Schematic			
SPDT	Note: Pins 4 and 6 not connected		
<b>GT12MV3BE</b>	OFF	NONE	ON
Conn. Terms.	OPEN	N/A	3-1
Schematic			
SPST	Note: Pins 4 and 6 not connected		

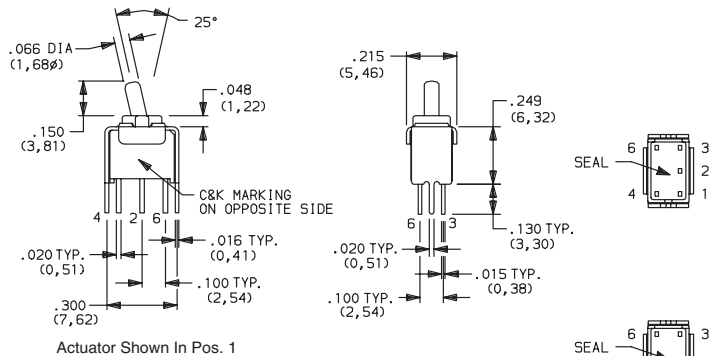

Actuator Shown In Pos. 1

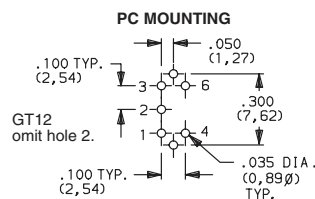

GT12 Models

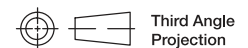

Dimensions are shown: Inches (mm)  
Specifications and dimensions subject to change



4 Mar 22



F

Toggle

# GT Series Sealed Ultraminiature Toggle Switches

GT21MV3BE  
DPDT

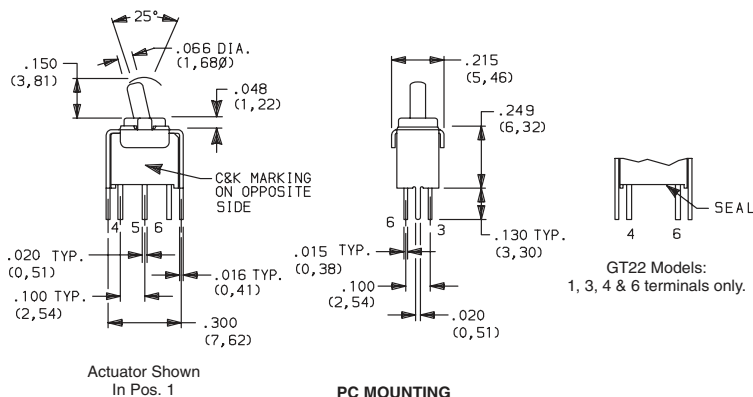

PART NUMBER	SWITCH FUNCTION		
	POS. 1	POS. 2	POS. 3
GT21MV3BE	ON	NONE	ON
GT23MV3BE	ON	OFF	ON
Conn. Terms.	2-3, 5-6	OPEN	2-1, 5-4
Schematic			
DPDT			
GT22MV3BE	OFF	NONE	ON
Conn. Terms.	OPEN	N/A	3-1, 6-4
Schematic			
DPST			

GT11MSABE  
Horizontal  
Actuation  
SPDT

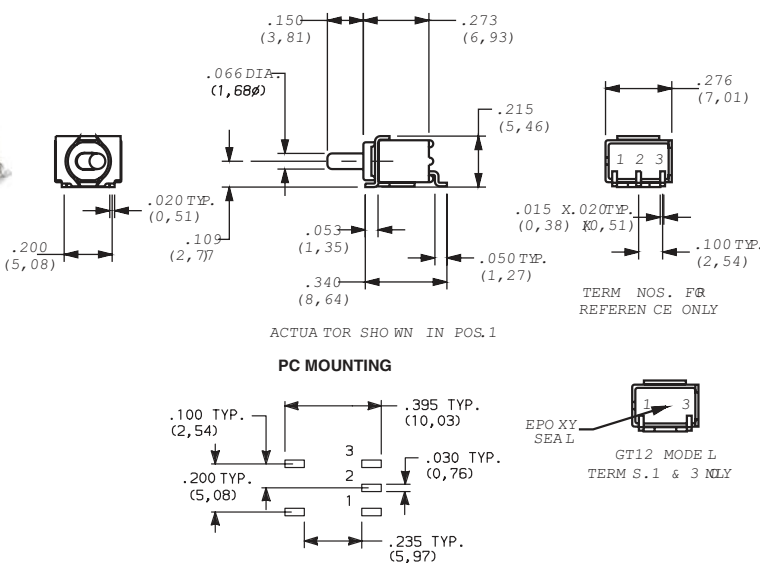

PART NUMBER	SWITCH FUNCTION		
	POS. 1	POS. 2	POS. 3
GT11MSABETR	ON	NONE	ON
GT13MSABETR	ON	OFF	ON
Conn. Terms.	2-3	OPEN	2-1
Schematic			
SPDT			
GT12MSABETR	OFF	NONE	ON
Conn. Terms.	OPEN	N/A	3-1
Schematic			
SPST			

Standard with tape & reel packaging, see page F-47.

GT12-omit pad 2.

GT11MSCBE  
SPDT

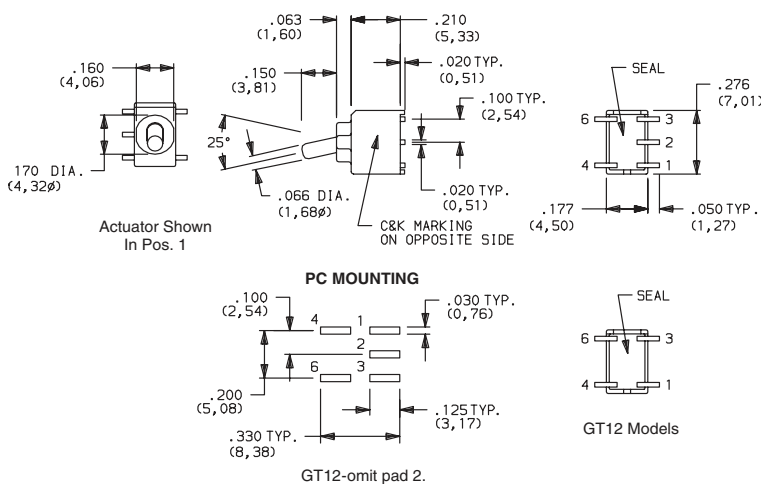

PART NUMBER	SWITCH FUNCTION		
	POS. 1	POS. 2	POS. 3
GT11MSCBETR	ON	NONE	ON
GT13MSCBETR	ON	OFF	ON
Conn. Terms.	2-3	OPEN	2-1
Schematic			
SPDT	Note: Pins 4 and 6 not connected		
GT12MSCBETR	OFF	NONE	ON
Conn. Terms.	OPEN	N/A	3-1
Schematic			
SPST	Note: Pins 4 and 6 not connected		

Standard with tape & reel packaging, see page F-47.

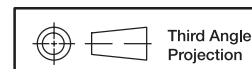

Dimensions are shown: Inches (mm)  
Specifications and dimensions subject to change

# GT Series Sealed Ultraminiature Toggle Switches



GT21MSCBE  
DPDT

PART NUMBER	SWITCH FUNCTION		
	POS. 1	POS. 2	POS. 3
<b>GT21MSCBETR</b>	ON	NONE	ON
<b>GT23MSCBETR</b>	ON	OFF	ON
Conn. Terms.	2-3, 5-6	OPEN	2-1, 5-4
Schematic			
DPDT			
<b>GT22MSCBETR</b>	OFF	NONE	ON
Conn. Terms.	OPEN	N/A	3-1, 6-4
Schematic			
DPST			

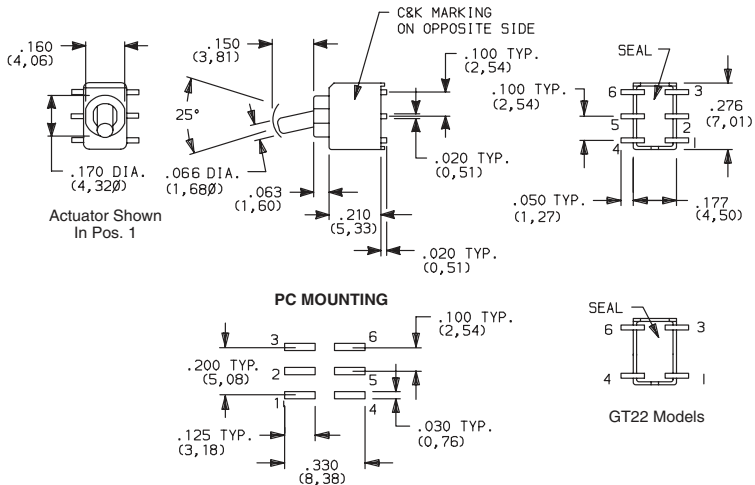

GT22-omit pads 2 & 5.  
Standard with tape & reel packaging

## TAPE & REEL

For part numbers GT11MSABE, GT12MSABE, GT13MSABE

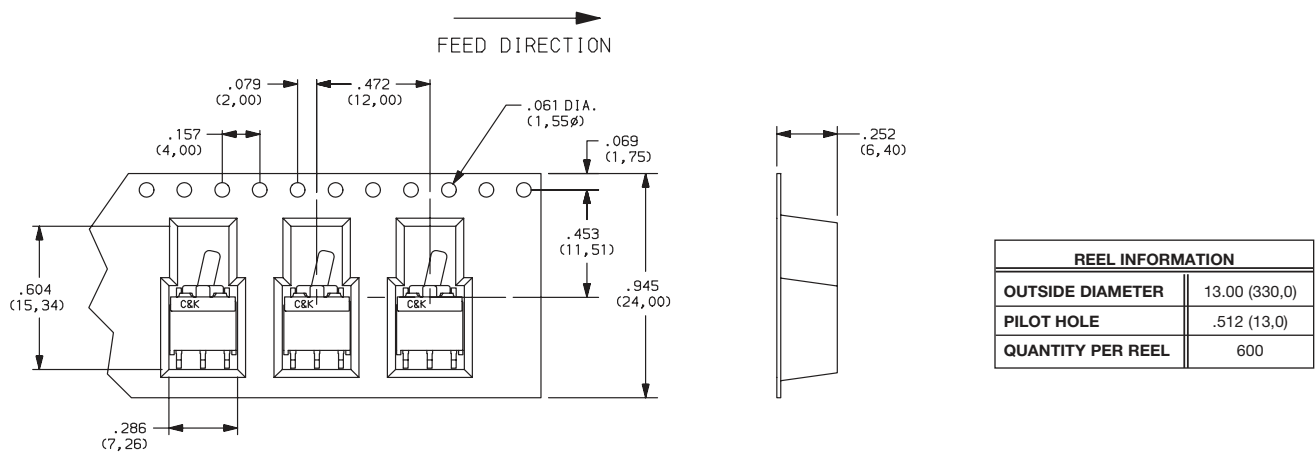

For part numbers GT11MSCBE, GT12MSCBE, GT13MSCBE, GT21MSCBE, GT22MSCBE, GT23MSCBE,

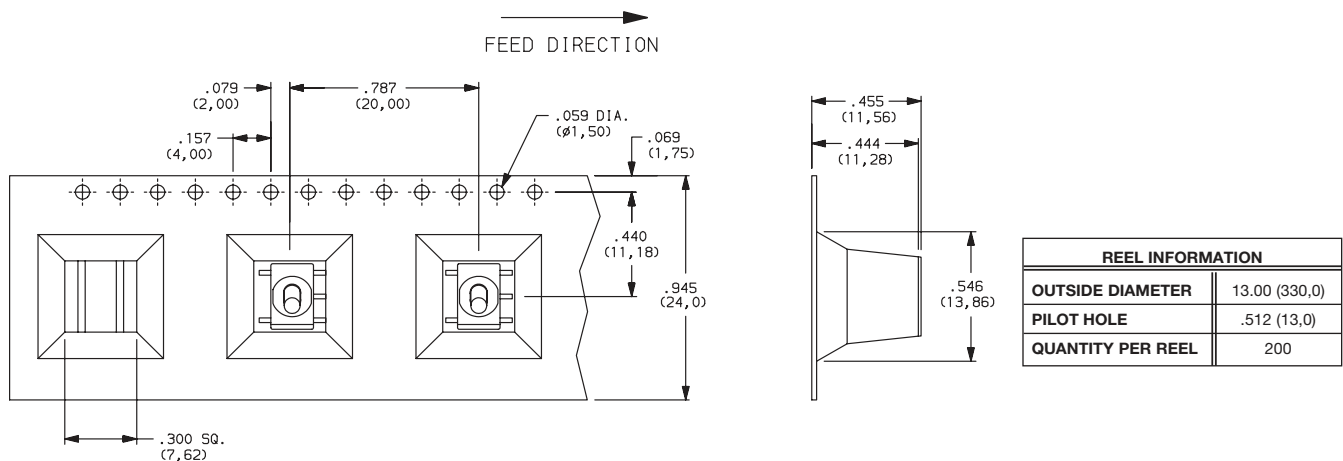

Dimensions are shown: Inches (mm)  
Specifications and dimensions subject to change

