



### Main

Range of Product	Modicon TM5
Product or Component Type	Analog input module
Analogue input number	1
Analogue input type	Full-bridge strain gauge 85...5000 Ohm differential
Analogue input resolution	24 bits

### Complementary

Range Compatibility	Modicon M258 Modicon LMC058
Product Compatibility	Logic controller Motion controller
Maximum number of sensors	4
Color	White
Type of Cable	Shielded cable
Isolation	No insulation between channels 500 Vrms AC insulation between channel and bus
Supply	Internal
[Us] rated supply voltage	24 V DC
Local signalling	1 LED green power supply 1 LED red power supply 1 LED green input status
Current consumption	2 mA 5 V DC bus 52 mA 24 V DC input/output 65 mA 5.5 V DC full-bridge (4/6 wires)
Maximum power dissipation in W	1.25 W
Marking	CE
Net Weight	0.06 lb(US) (0.025 kg)

### Environment

Temperature Drift	10 ppm/°C
Standards	IEC 61131-2 CSA C22.2 No 142 CSA C22.2 No 213 UL 508
Product Certifications	CULus GOST-R CSA C-tick
Ambient air temperature for operation	32...131 °F (0...55 °C) without derating horizontal installation) 32...140 °F (0...60 °C) with derating factor horizontal installation) 32...122 °F (0...50 °C) vertical installation)
Ambient Air Temperature for Storage	-13...158 °F (-25...70 °C)
Relative humidity	5...95 % without condensation
IP degree of protection	IP20IEC 61131-2
Pollution degree	2 IEC 60664

Operating altitude	0...6561.68 ft (0...2000 m)
Storage altitude	0.00...9842.52 ft (0...3000 m)
Vibration resistance	1 gn 8.4...150 Hz DIN rail 3.5 mm 5...8.4 Hz DIN rail
Shock resistance	15 gn 11 ms
Resistance to electrostatic discharge	4 KV on contact EN/IEC 61000-4-2 8 kV in air EN/IEC 61000-4-2
Resistance to electromagnetic fields	0.91 V/M (1 V/m) 2...2.7 GHz EN/IEC 61000-4-3 9.14 V/m (10 V/m) 80...2000 MHz EN/IEC 61000-4-3
Resistance to fast transients	1 KV EN/IEC 61000-4-4 I/O) 1 KV EN/IEC 61000-4-4 shielded cable) 2 kV EN/IEC 61000-4-4 power lines)
Surge withstand	0.5 KV differential mode EN/IEC 61000-4-5 1 kV common mode EN/IEC 61000-4-5
Electromagnetic compatibility	EN/IEC 61000-4-6
Disturbance radiated/conducted	CISPR 11

## Ordering and shipping details

Category	22532-M258 PLC
Discount Schedule	PC12
GTIN	3595864145150
Nbr. of units in pkg.	1
Package weight(Lbs)	1.34 oz (38.0 g)
Returnability	No
Country of origin	AT

## Packing Units

Unit Type of Package 1	PCE
Package 1 Height	0.79 in (2 cm)
Package 1 width	2.36 in (6 cm)
Package 1 Length	4.13 in (10.5 cm)
Unit Type of Package 2	S02
Number of Units in Package 2	97
Package 2 Weight	8.66 lb(US) (3.927 kg)
Package 2 Height	5.91 in (15 cm)
Package 2 width	11.81 in (30 cm)
Package 2 Length	15.75 in (40 cm)

## Offer Sustainability

Sustainable offer status	Green Premium product
California proposition 65	WARNING: This product can expose you to chemicals including: Lead and lead compounds, which is known to the State of California to cause cancer and birth defects or other reproductive harm. For more information go to <a href="http://www.P65Warnings.ca.gov">www.P65Warnings.ca.gov</a>
REACH Regulation	<a href="#">REACH Declaration</a>
REACH free of SVHC	Yes
EU RoHS Directive	Pro-active compliance (Product out of EU RoHS legal scope) <a href="#">EU RoHS Declaration</a>
Toxic heavy metal free	Yes
Mercury free	Yes
RoHS exemption information	<a href="#">Yes</a>
China RoHS Regulation	<a href="#">China RoHS Declaration</a>
Environmental Disclosure	<a href="#">Product Environmental Profile</a>
Circularity Profile	<a href="#">End Of Life Information</a>
WEEE	The product must be disposed on European Union markets following specific waste collection and never end up in rubbish bins.
PVC free	Yes

## Contractual warranty

---

Warranty	18 months
----------	-----------

---

## TM5 Slice

### Dimensions

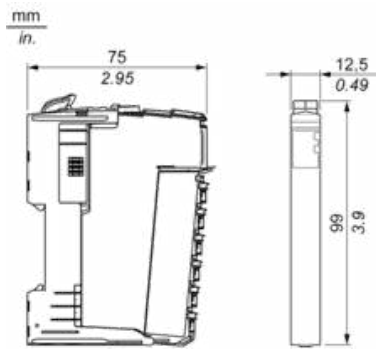

TM5 System

Spacing Requirements

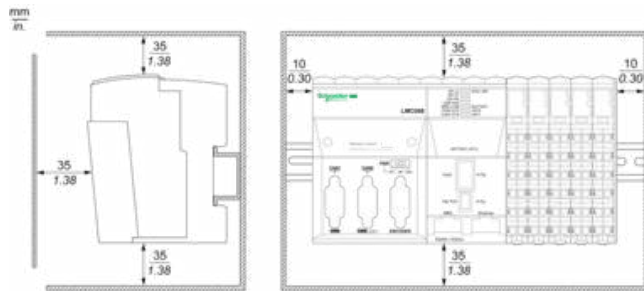



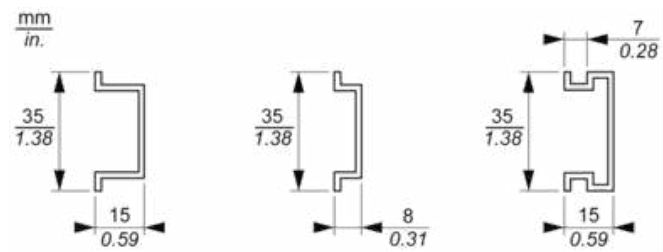

Mounting on a DIN Rail



TM5 System Wiring Recommendations

Wire Sizes to Use with the Removable Spring Terminal Blocks

mm in.				
mm <sup>2</sup>	0,08...2,5	0,25...2,5	0,25...1,5	2 x 0,25...2 x 0,75
AWG	28...14	24...14	24...16	2 x 24...2 x 18

Wiring Diagram

With a 6-Wire Full-Bridge Strain Gauge

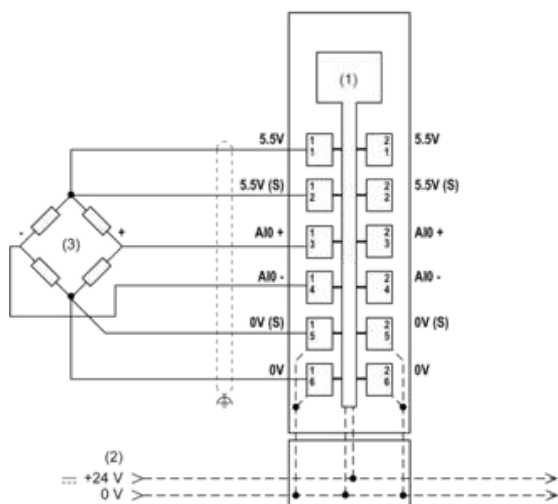

- (1): Internal electronics
- (2): 24 Vdc I/O power segment integrated into the bus bases
- (3): 6-wire full-bridge strain gauge
- (S): Sensor

With Two 4-Wire Full-Bridge Strain Gauges

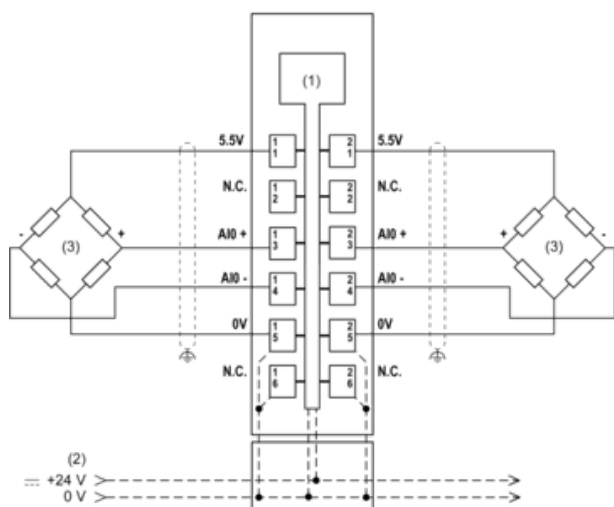

- (1): Internal electronics
- (2): 24 Vdc I/O power segment integrated into the bus bases
- (3): 4-wire full-bridge strain gauge