

C&K E Series Sealed Miniature Rocker and Lever Handle Switches



Features/Benefits

- Sealed against solder and cleaning process contaminants
- ESD Resistance—all actuator options
- Rocker, case & bushing UL 94V-0

Typical Applications

- Telecommunications
- Instrumentation
- Computers & peripherals

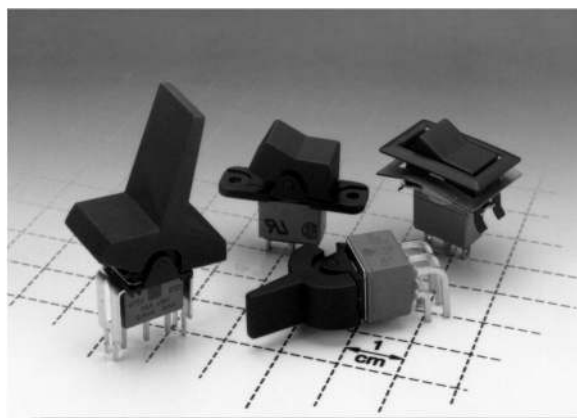

Build-A-Switch

Our easy Build-A-Switch concept allows you to mix and match options to create the switch you need. Below is a complete listing of options shown in catalog. To order, simply select desired option from each category and place in the appropriate box. Switches with standard options are shown on pages F-24 and F-25. Available options are shown and described on pages F-25 thru F-35. For additional options not shown in catalog, consult Customer Service Center. All models are process sealed to withstand machine soldering temperatures and pressure wash cleaning methods.

Typical Example: E 1 0 1 — J 1 — Z — Q — E — 2 —

Switch Function

- E101** (STD.) SP On-None-On
- E201** (STD.) DP On-None-On
- E301** (STD.) 3P On-None-On
- E103** SP On-Off-On
- E105** SP Mom.-Off-Mom.
- E107** SP On-Off-Mom.
- E108** SP On-None-Mom.
- E203** DP On-Off-On
- E205** DP Mom.-Off-Mom.
- E207** DP On-Off-Mom.
- E208** DP On-None-Mom.
- E211** DP On-On-On
- E213** DP On-On-Mom.
- E215** DP Mom.-On-Mom.
- E303** 3P On-Off-On
- E305** 3P Mom.-Off-Mom.
- E307** 3P On-Off-Mom.
- E308** 3P On-None-Mom.

Actuator

- J1** (STD.) Rocker
- J2** Lever
- J3** Rocker
- J8** Rocker
- J11** Rocker with frame
- J21** Lever with frame
- J50** Rocker
- J60** Lever
- J90** Lever

Terminations

- A** (STD.) Right angle, PC thru-hole
- AV2** (STD.) Vertical right angle, PC thru-hole
- C** (STD.) PC Thru-hole
- Z** (STD.) Solder lug
- A3** Right angle, snap-in, PC thru-hole
- AV3** Vertical right angle, snap-in, PC thru-hole
- AW** Right angle, extended, PC thru-hole
- AW1** Right angle, extended, PC thru-hole
- AW3** Right angle, extended, PC thru-hole
- AW4** Right angle, extended, PC thru-hole
- V2** .555" high, V-bracket
- V3** .460" high, V-bracket
- V4** .630" high, V-bracket
- V5** Vertical right angle, PC thru-hole
- V6** .460" high, V-bracket
- V7** .630" high, V-bracket
- V8** .953" high, V-bracket
- V9** 1.150" high, V-bracket
- V21** .555" high, V-bracket, snap-in
- V31** .460" high, V-bracket, snap-in
- V41** .630" high, V-bracket, snap-in
- V51** Vertical right angle, snap-in
- V54** Vertical right angle, extended
- V55** Vertical right angle, extended
- V61** .460" high, V-bracket, snap-in
- V71** .630" high, V-bracket, snap-in
- V81** .953" high, V-bracket, snap-in
- V91** 1.150" high, V-bracket, snap-in
- W** .750" long, wire wrap
- W1** .964" long, wire wrap
- W3** .425" long, wire wrap
- W4** 1.062" long, wire wrap
- W5** 1.305" long, wire wrap
- Z3** Quick connect

Contact Material

- B** (STD.) Gold
- Q** (STD.) Silver
- K** Gold
- M** Silver
- G** Gold over silver
- L** Gold over silver

Seal

- E** (STD.) Epoxy

Actuator Color

- 2** (STD.) Black
- 1** White
- 3** Red

Frame Color

- 2** (STD.) Black
- NONE** No frame color required
- 1** White

Metal Frame Color (J11, J21 Actuators)

- 2** (STD.) Black
- 1** White
- C** Bright chrome
- S** Satin chrome



F

Rocker

C&K E Series Sealed Miniature Rocker and Lever Handle Switches

SWITCHES WITH STANDARD OPTIONS

PART NUMBER	FUNCTION	POS. 1	POS. 2	POS. 3
E101J1V3BE2	SPDT	ON	NONE	ON

NOTE: For PC mounting information, see page F-34.

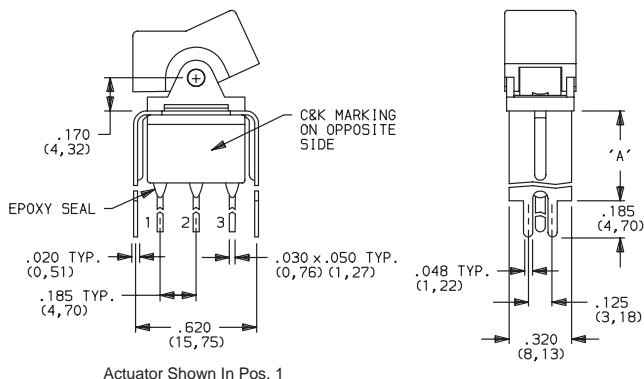

E101J1V3BE2
SPDT

PART NUMBER	FUNCTION	POS. 1	POS. 2	POS. 3
E101J1ABE2 E103J1ABE2 E105J1ABE2 E107J1ABE2	SPDT	ON ON MOM. ON	NONE OFF OFF OFF	ON ON MOM. MOM.

MOM. = Momentary

NOTE: For PC mounting information, see page F-29.

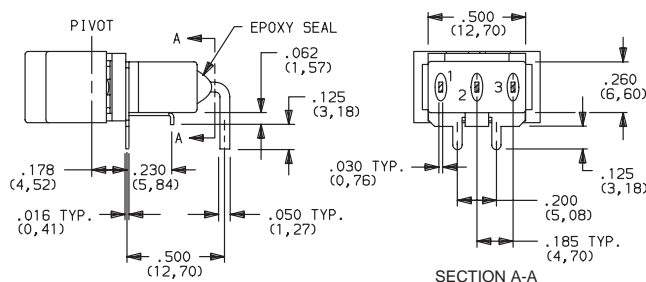

E101J1ABE2
Horizontal Actuation
SPDT

PART NUMBER	FUNCTION	POS. 1	POS. 2	POS. 3
E201J1AV2QE2	DPDT	ON	NONE	ON

NOTE: For PC mounting information, see page F-31.

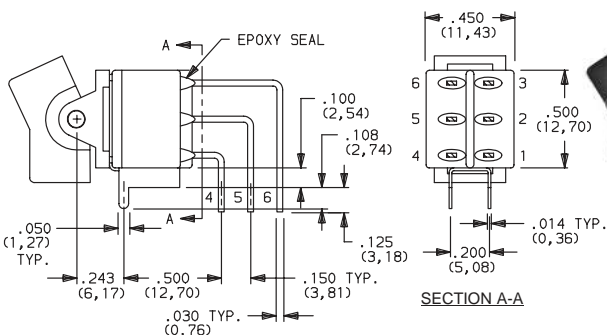

E201J1AV2BE2
Vertical Actuation
DPDT

SWITCH FUNCTION

NO. POLES	MODEL NO.	SWITCH FUNCTION			CONNECTED TERMINALS			SCHEMATIC
		POS. 1	POS. 2	POS. 3	POS. 1	POS. 2	POS. 3	
SP	E101 (STD.)	ON	NONE	ON				
	E103	ON	OFF	ON				
	E105	MOM.	OFF	MOM.	2-3	OPEN	2-1	
	E107	ON	OFF	MOM.				
	E108	ON	NONE	MOM.				

MOM. = Momentary

** Wiring for 3-way switch, see page L-29.

All models with all options when ordered with G, L, M or Q contact material.

C&K E Series Sealed Miniature Rocker and Lever Handle Switches

SWITCH FUNCTION

NO. POLES	MODEL NO.	SWITCH FUNCTION			CONNECTED TERMINALS			SCHEMATIC
		POS. 1	POS. 2	POS. 3	POS. 1	POS. 2	POS. 3	
DP	E201 (STD.)	ON	NONE	ON	2-3,5-6	OPEN	2-1,5-4	
	E203	ON	OFF	ON				
	E205	MOM.	OFF	MOM.				
	E207	ON	OFF	MOM.	2-3,5-6	2-3,5-4	2-1,5-4	
	E208	ON	NONE	MOM.				
	E211**	ON	ON	ON				
	E213**	ON	ON	MOM.				
E215**	MOM.	ON	MOM.	DPDT				
3P	E301 (STD.)	ON	NONE	ON	2-3,5-6,8-9	OPEN	2-1,5-4,8-7	
	E303	ON	OFF	ON				
	E305	MOM.	OFF	MOM.				
	E307	ON	OFF	MOM.				
	E308	ON	NONE	MOM.				

MOM. = Momentary

All models with all options when ordered with G, L, M or Q contact material.

** Wiring for 3-way switch, see page L-29.

ACTUATOR—PANEL REAR MOUNT

ACTUATOR COLOR

ACTUATOR

J1 (STD.) ROCKER

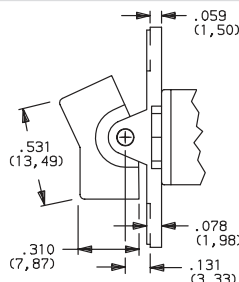
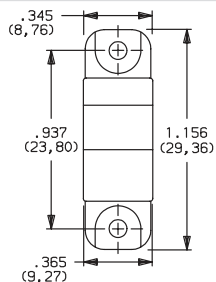

OPTION CODE	ACTUATOR COLOR
2	(STD.) BLACK
1	WHITE
3	RED

Finish: Matte. Other colors, custom actuator markings and legends available, consult Customer Service Center.

NOTE: Hardware: two each—mounting screws, nuts, lockwashers and standoffs for 1/8 inch thick panel are supplied standard on switches with panel mounting bracket. Internal o-ring actuator seal standard. Actuators and hardware are available separately, see section L. J1, J2 & J8 actuators available with C, W-W5, Z or Z3 terminations.

J2 LEVER

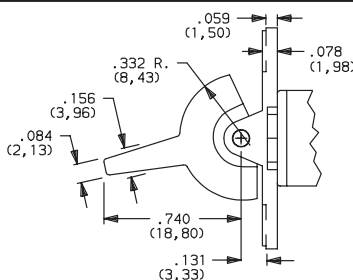
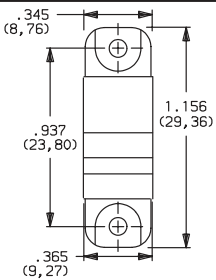

PANEL MOUNTING

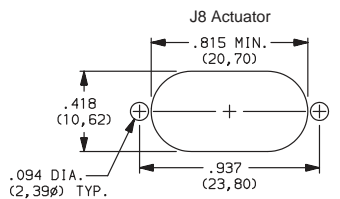
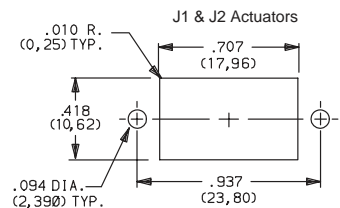

J8 ROCKER

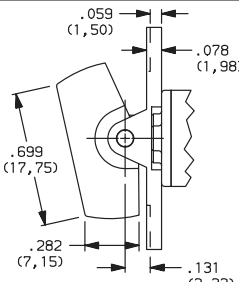
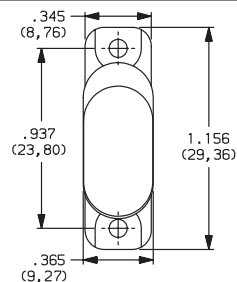

C&K E Series Sealed Miniature Rocker and Lever Handle Switches

ACTUATOR—REAR MOUNT

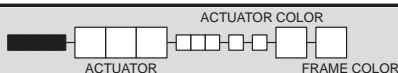

OPTION CODE	ACTUATOR COLOR
2	(STD.) BLACK
1	WHITE
3	RED

OPTION CODE	FRAME COLOR
2	(STD.) BLACK
1	WHITE
C	BRIGHT CHROME
S	SATIN CHROME

Actuator finish: Matte, frame finish: gloss. Other colors, custom actuator markings and legends available, consult Customer Service Center.

NOTE: Internal o-ring actuator seal standard. Frames are available separately, see section L. J11 & J21 actuators available with C, W-W5, Z & Z3 terminations.

PANEL MOUNTING

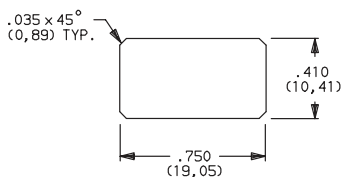

J11 ROCKER WITH FRAME

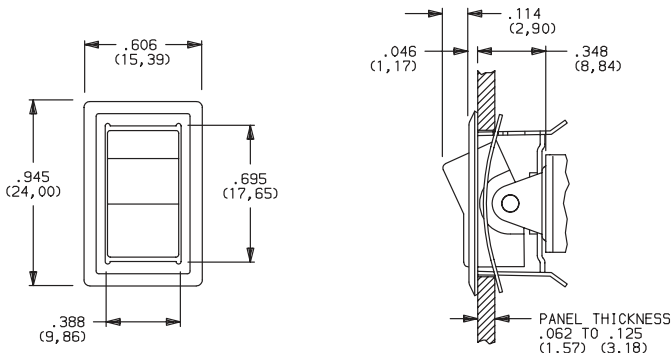

NOTE: This option has reduced anti-static capability.

J21 LEVER WITH FRAME

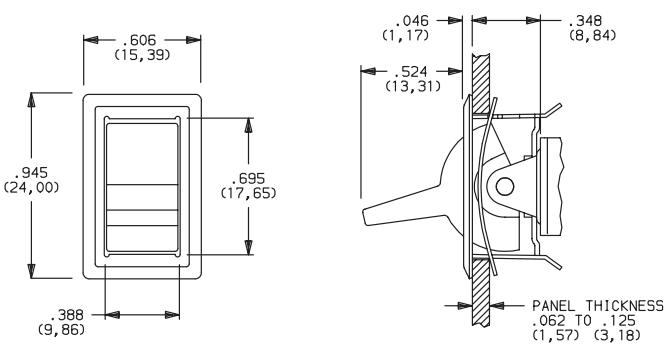

NOTE: This option has reduced anti-static capability.

ACTUATOR—PC MOUNT

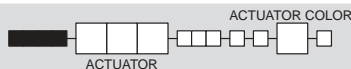

OPTION CODE	ACTUATOR COLOR
2	(STD.) BLACK
1	WHITE
3	RED

Finish: Matte. Other colors, custom actuator markings and legends available, consult Customer Service Center.

NOTE: Hardware: two each—mounting screws, nuts, lockwashers and standoffs for 1/8 inch thick panel are supplied standard on switches with panel mounting bracket. Internal o-ring actuator seal standard. Actuators and hardware are available separately, see section L. J1, J2 & J8 actuators available with A, A3, AV2, AV3, V2-V91 & AW-AW4 terminations.

J1 ROCKER

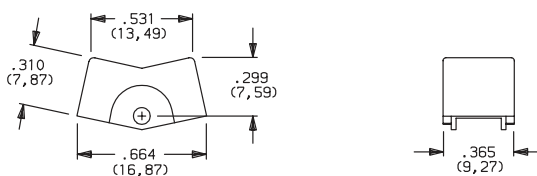

J2 LEVER

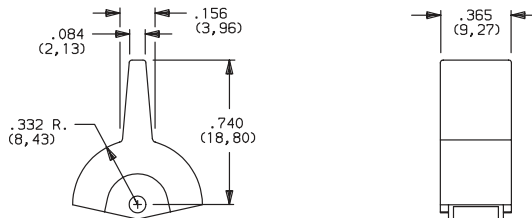

J8 ROCKER

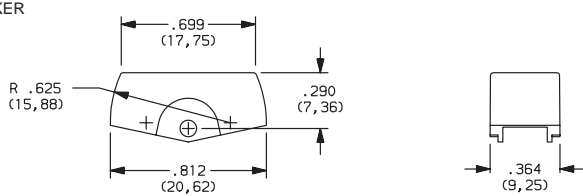

Rocker

C&K E Series Sealed Miniature Rocker and Lever Handle Switches

ACTUATOR—PC MOUNT

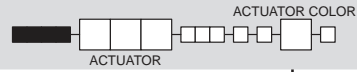

J3 ROCKER

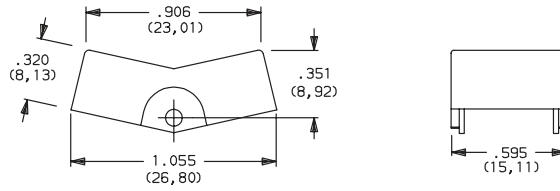

J50 ROCKER

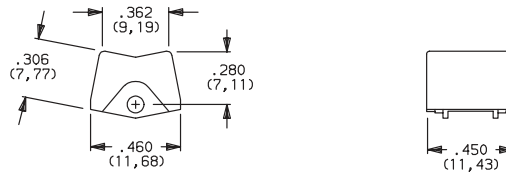

J60 LEVER

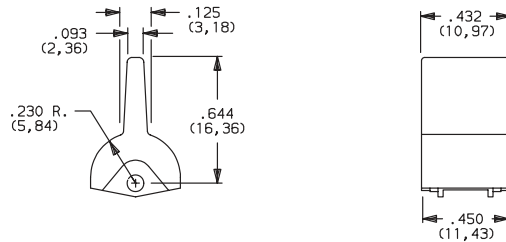

J90 LEVER

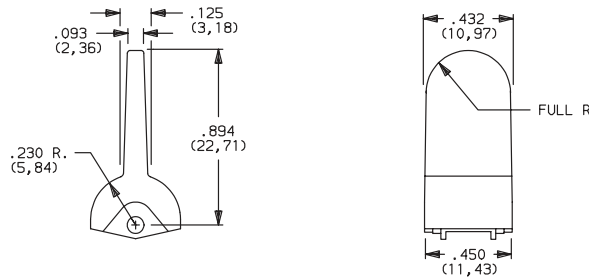

OPTION CODE	ACTUATOR COLOR
2	(STD.) BLACK
1	WHITE
3	RED

Finish: Matte. Other colors, custom actuator markings and legends available, consult Customer Service Center.

NOTE: Hardware: two each—mounting screws, nuts, lockwashers and standoffs for 1/8 inch thick panel are supplied standard on switches with panel mounting bracket. Internal o-ring actuator seal standard. Actuators and hardware are available separately, see section L.

J3 actuators available with AV2, AV3 & V2-V91 terminations. Some permissible actuator/termination combinations may lack clearance between actuator and PC board, and care must be exercised to accommodate this condition.

J50, J60 & J90 actuators available with A, AV2, AV3 & AW-AW4 terminations.

TERMINATIONS



Z (STD.) SOLDER LUG

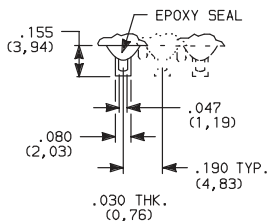

C (STD.) PC THRU-HOLE

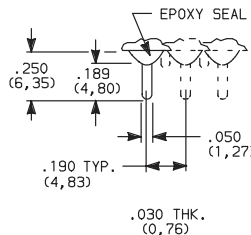

PC MOUNTING

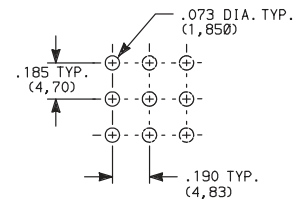

SPDT thru 3PDT

Not available with K, L or M contact materials. Available actuators, see page F-26.

SPDT thru 3PDT

NOTE: Available actuators, see pages, F-27 and F-28.

C&K E Series Sealed Miniature Rocker and Lever Handle Switches

TERMINATIONS

Z3 QUICK CONNECT

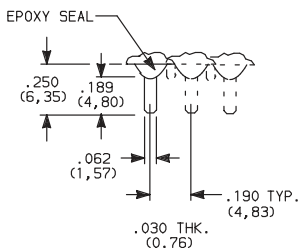

Not available with K, L or M contact materials.
Available actuators, see pages F-27 and F-28. Mating quick connector available; order part number 530100000.

SPDT thru 3PDT

W, W1, W3, W4, W5 WIRE WRAP

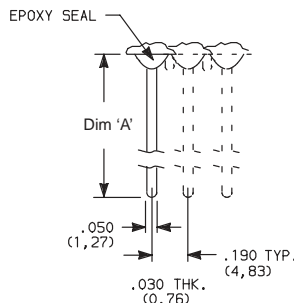

OPTION CODE	DIM 'A'
W	.750 (19,05)
W1	.964 (24,48)
W3	.425 (10,80)
W4	1.062 (26,97)
W5	1.305 (33,15)

SPDT thru 3PDT

NOTE: Available actuators, see pages F-27 and F-28.

A (STD.) RIGHT ANGLE, PC THRU-HOLE

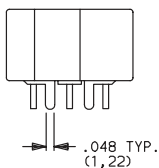

Actuator Shown In Pos. 1

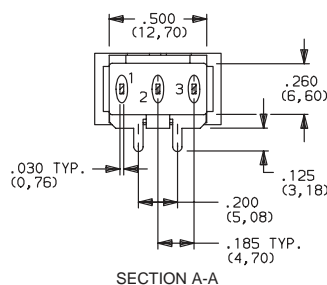
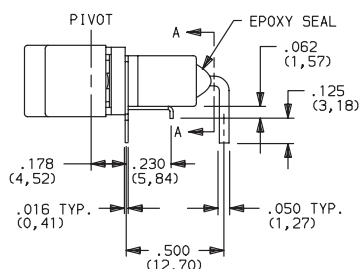

E101J1ABE2
Horizontal Actuation
SPDT

A3 RIGHT ANGLE, SNAP-IN, PC THRU-HOLE

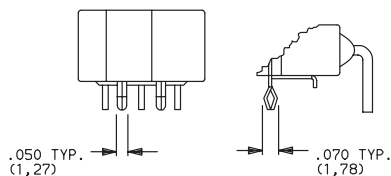

AW, AW1, AW3, AW4 RIGHT ANGLE, EXTENDED, PC THRU-HOLE

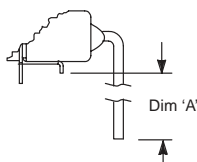

OPTION CODE	DIM 'A'
AW	.44 (11,2)
AW1	.66 (16,8)
AW3	.14 (3,6)
AW4	.77 (19,6)

PC MOUNTING

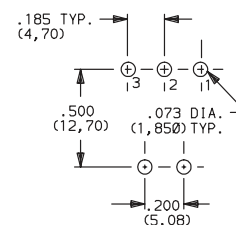

NOTE: PC mounting pattern must clear switch support leg.

NOTE: Not available with J3, J50, J60 and J90 actuators.
Available actuators, see pages F-27 and F-28.
Terminal bend radii and lead-in manufacturing option.



C&K E Series Sealed Miniature Rocker and Lever Handle Switches

TERMINATIONS

A (STD.) RIGHT ANGLE, PC THRU-HOLE



E201J1ABE2
Horizontal Actuation
DPDT

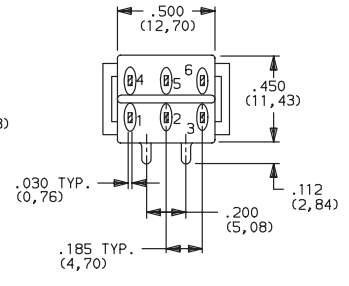
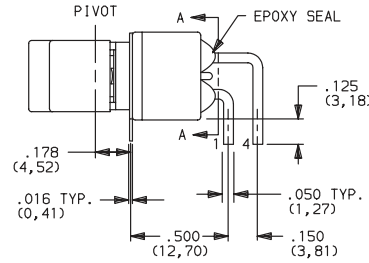
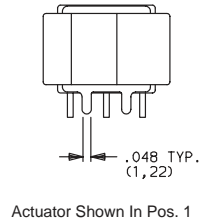

A3 RIGHT ANGLE, SNAP-IN, PC THRU-HOLE

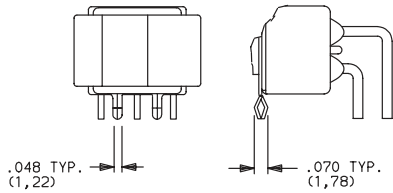

AW, AW1, AW4, AW5 RIGHT ANGLE, EXTENDED, PC THRU-HOLE

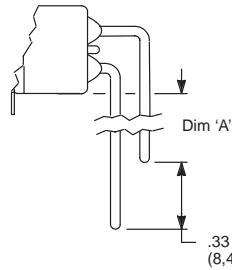

OPTION CODE	DIM 'A'
AW	.21 (5,3)
AW1	.42 (10,7)
AW4	.52 (13,2)
AW5	.76 (19,3)

PC MOUNTING

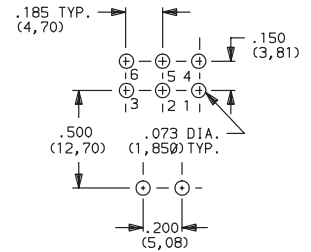

NOTE: NOTE: Not available with J3 actuator.
Available actuators, see pages F-27 and F-28.
Terminal bend radii and lead-in manufacturing option.

A (STD.) RIGHT ANGLE, PC THRU-HOLE



E301J1ABE2
Horizontal Actuation
3PDT

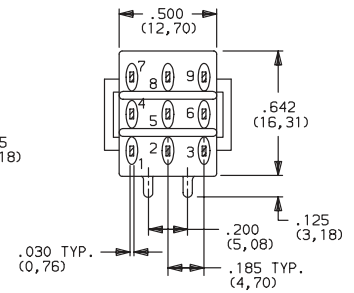
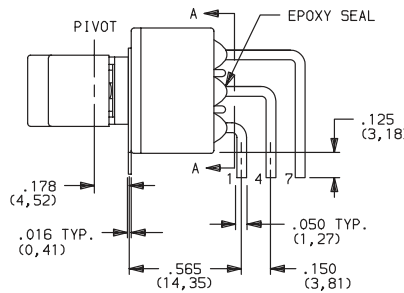
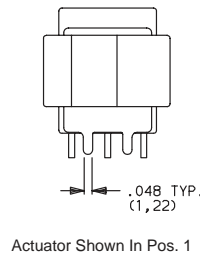

AW4, AW5 RIGHT ANGLE, EXTENDED, PC THRU-HOLE

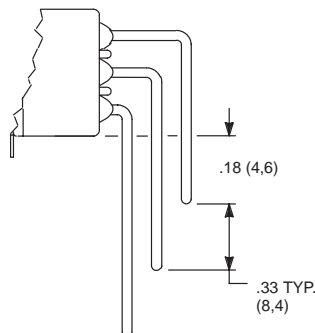

PC MOUNTING

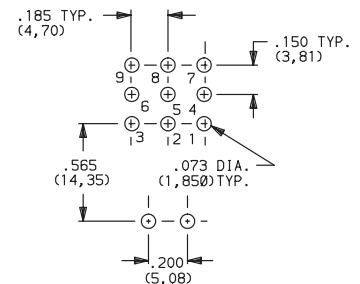

NOTE: Terminal bend radii and lead-in manufacturing option.
Available actuators, see pages F-27 and F-28.



F
Rocker

C&K E Series Sealed Miniature Rocker and Lever Handle Switches

TERMINATIONS

AV2 (STD.) VERTICAL RIGHT ANGLE, PC THRU-HOLE, .150" PITCH

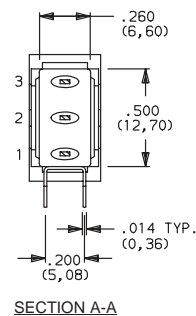
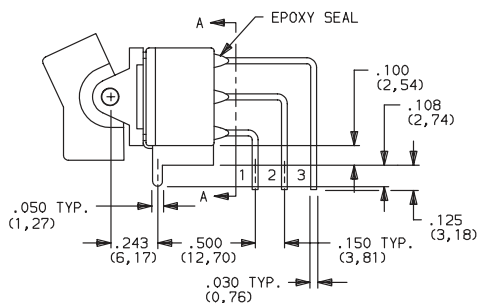
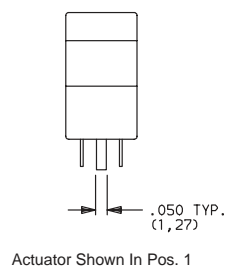

E101J1AV2BE2
Vertical Actuation
SPDT

AV3 VERTICAL RIGHT ANGLE, SNAP-IN, PC THRU-HOLE, .150" PITCH

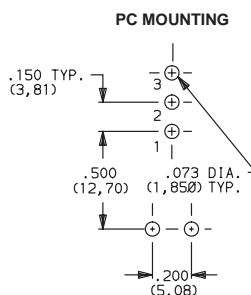
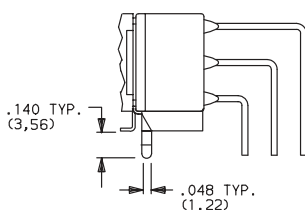
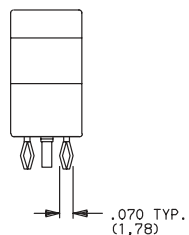

NOTE: Terminal bend radii and lead-in manufacturing option. Available actuators, see pages F-27 and F-28.

AV2 (STD.) VERTICAL RIGHT ANGLE, PC THRU-HOLE, .150" PITCH

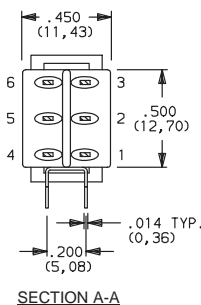
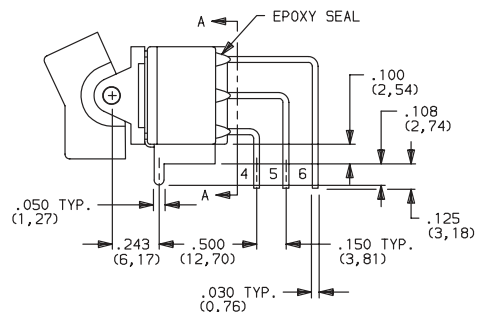
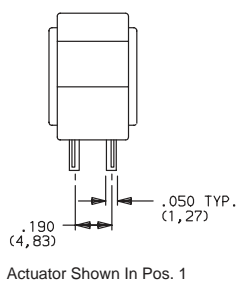

E201J1AV2BE2
Vertical Actuation
DPDT

AV3 VERTICAL RIGHT ANGLE, SNAP-IN, PC THRU-HOLE, .150" PITCH

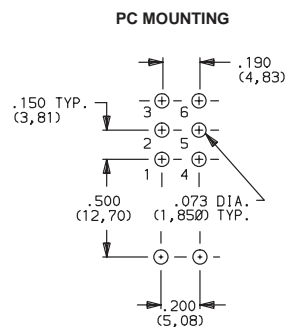
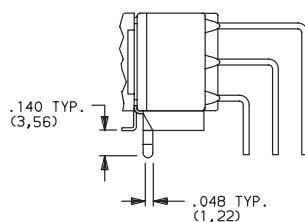
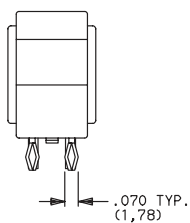

NOTE: Terminal bend radii and lead-in manufacturing option. Available actuators, see pages F-27 and F-28.

C&K E Series Sealed Miniature Rocker and Lever Handle Switches

TERMINATIONS

V5 VERTICAL RIGHT ANGLE, PC THRU-HOLE,
.150" PITCH

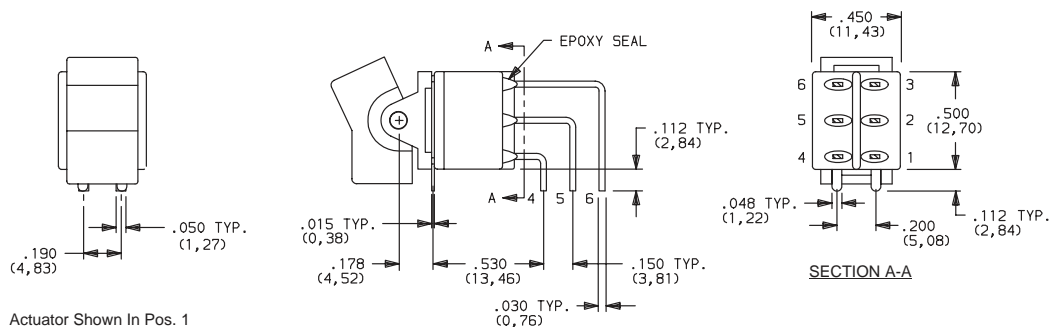

E201J1V5BE2
Vertical Actuation
DPDT

V51 VERTICAL RIGHT ANGLE, SNAP-IN,
PC THRU-HOLE, .150" PITCH

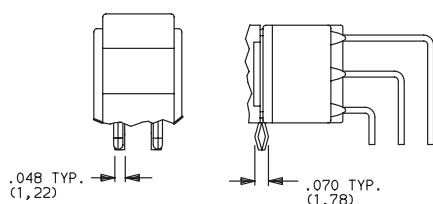

V54, V55 VERTICAL RIGHT ANGLE, EXTENDED,
PC THRU-HOLE, .150" PITCH

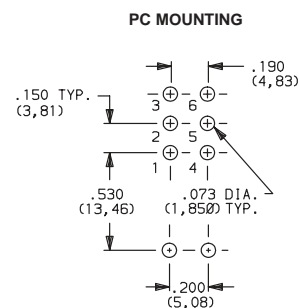
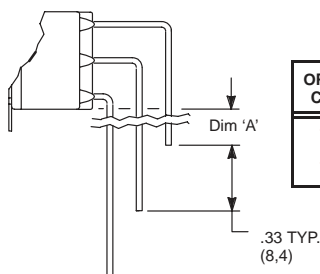

NOTE: Terminal bend radii and lead-in manufacturing option.
Available actuators, see pages F-27 and F-28.

V2, V6, V7, V8 VERTICAL MOUNT, V-BRACKET

V21, V61, V71, V81 VERTICAL MOUNT, V-BRACKET, SNAP-IN

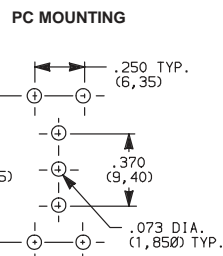
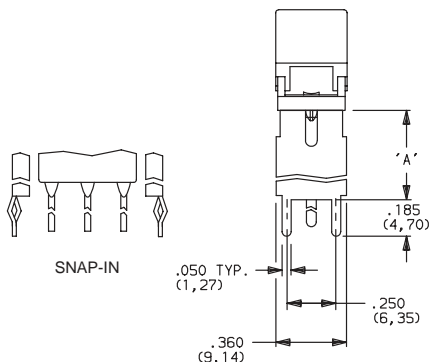
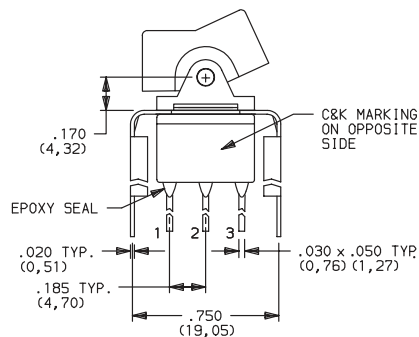

E101J1_BE2
SPDT

OPTION CODE	DIM 'A'
V2, V21	.555 (14,10)
V6, V61	.460 (11,68)
V7, V71	.630 (16,00)
V8, V81	.953 (24,21)

NOTE: Available actuators, see pages F-27 and F-28.

C&K E Series Sealed Miniature Rocker and Lever Handle Switches

TERMINATIONS

V2, V6, V7, V8 VERTICAL MOUNT, V-BRACKET

V21, V61, V71, V81 VERTICAL MOUNT, V-BRACKET, SNAP-IN



E201J1__BE2
DPDT

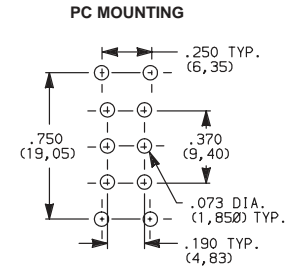
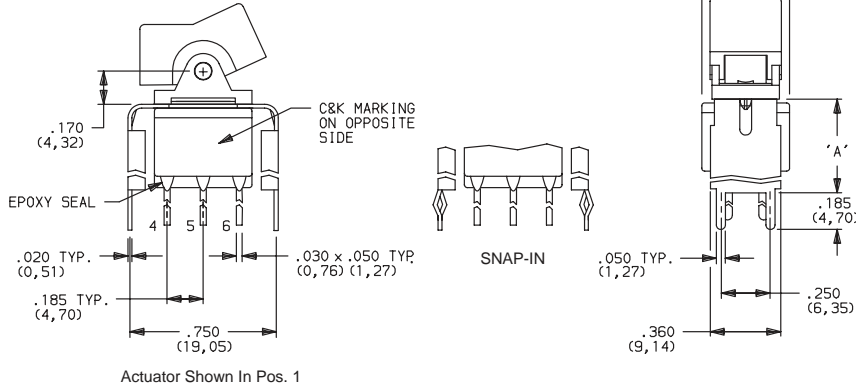

OPTION CODE	DIM 'A'
V2, V21	.555 (14,10)
V6, V61	.460 (11,68)
V7, V71	.630 (16,00)
V8, V81	.953 (24,21)

NOTE: Available actuators, see pages F-27 and F-28.

V2, V7, V8 VERTICAL MOUNT, V-BRACKET

V21, V71, V81 VERTICAL MOUNT, V-BRACKET, SNAP-IN



E301J1__BE2
3PDT

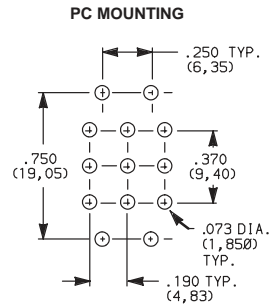
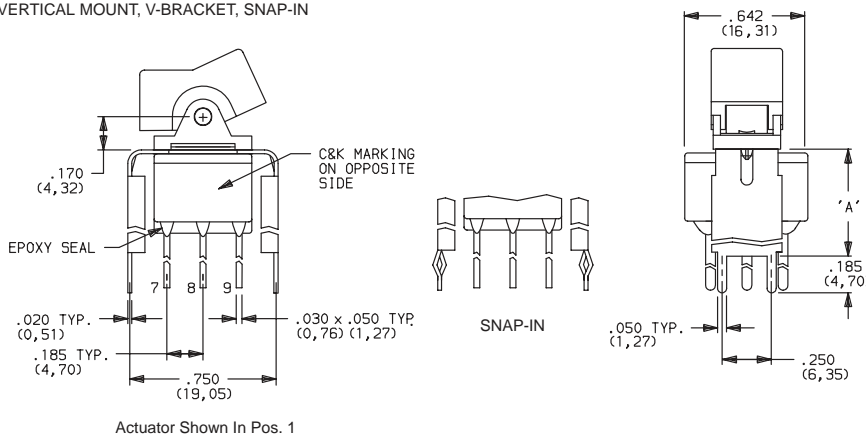

OPTION CODE	DIM 'A'
V2, V21	.555 (14,10)
V7, V71	.630 (16,00)
V8, V81	.953 (24,21)

NOTE: Available actuators, see pages F-27 and F-28.

V3, V4, V9 VERTICAL MOUNT, V-BRACKET

V31, V41, V91 VERTICAL MOUNT, V-BRACKET, SNAP-IN



E101J1__BE2
SPDT

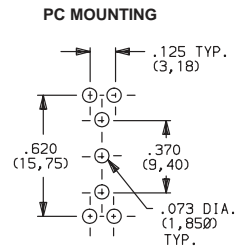
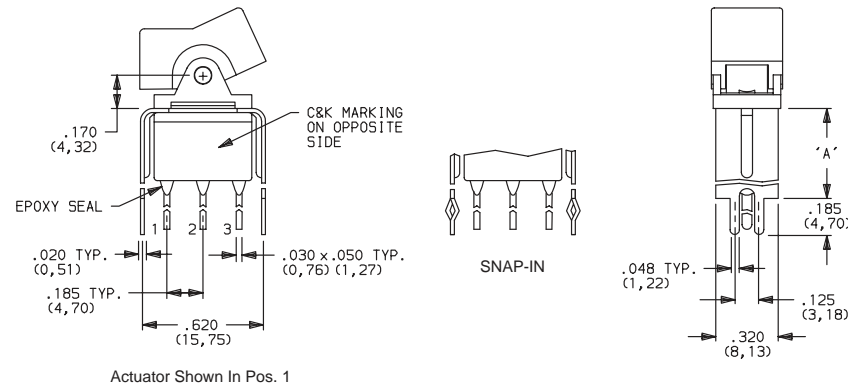

OPTION CODE	DIM 'A'
V3, V31	.460 (11,68)
V4, V41	.630 (16,00)
V9, V91	1.150 (29,21)

NOTE: Available actuators, see pages F-27 and F-28.



Rocker

C&K E Series Sealed Miniature Rocker and Lever Handle Switches

TERMINATIONS

V3, V4, V9 VERTICAL MOUNT, V-BRACKET

V31, V41, V91 VERTICAL MOUNT, V-BRACKET, SNAP-IN

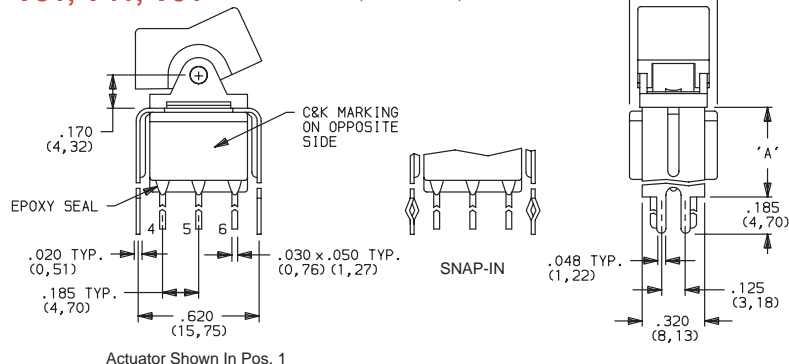

PC MOUNTING



E201J1_BE2
DPDT

OPTION CODE	DIM 'A'
V3, V31	.460 (11,68)
V4, V41	.630 (16,00)
V9, V91	1.150 (29,21)

NOTE: Available actuators, see pages F-27 and F-28.

V4, V9 VERTICAL MOUNT, V-BRACKET

V41, V91 VERTICAL MOUNT, V-BRACKET, SNAP-IN

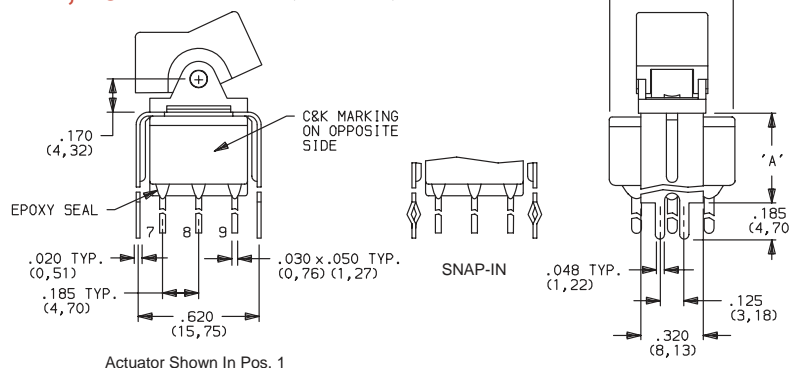

PC MOUNTING



E301J1_BE2
3PDT

OPTION CODE	DIM 'A'
V4, V41	.630 (16,00)
V9, V91	1.150 (29,21)

NOTE: Available actuators, see pages F-27 and F-28.

CONTACT MATERIAL

OPTION CODE	CONTACT MATERIAL	TERMINAL PLATING	RATINGS	
B (STD.)	GOLD ¹	GOLD ¹	LOW LEVEL/DRY CIRCUIT	0.4 VA MAX. @ 20 V AC OR DC MAX.
K		TIN-LEAD ⁶		
Q (STD.)	SILVER ^{4,5}	SILVER ⁵	POWER	E1XX & E2XX MODELS: 7.5 AMPS @ 125 V AC OR 28 V DC; 3 AMPS @ 250 V AC. E3XX MODELS: 5 AMPS @ 125 V AC OR 28 V DC; 2 AMPS @ 250 V AC.
M		TIN-LEAD ⁶		
G	GOLD OVER SILVER ^{2,3}	GOLD ³	LOW LEVEL/DRY CIRCUIT OR POWER	E1XX AND E2XX MODELS: 0.4 VA MAX @ 20 V AC OR DC MAX. OR 7.5 AMPS @ 125 V AC OR 28 V DC; 3 AMPS @ 250 V AC. E3XX MODELS: 0.4 VA MAX. @ 20 V AC OR DC MAX. OR 5 AMPS @ 125 V AC OR 28 V DC; 2 AMPS @ 250 V AC.
L		TIN-LEAD ⁶		

CONTACT MATERIAL/APPLICATION RECOMMENDATIONS—SEE CHART, PAGE L-31.

¹ CONTACTS & TERMINALS: Copper alloy, with gold plate over nickel plate.

² END CONTACTS: Coin silver, with gold plate over nickel plate.

³ CENTER CONTACTS & ALL TERMINALS: Copper alloy, with gold plate over nickel plate.

⁴ END CONTACTS: Coin silver, silver plated.

⁵ CENTER CONTACT & ALL TERMINALS: Copper alloy, silver plated.

⁶ TERMINALS: Copper alloy, with tin-lead alloy over nickel plate.

All models with all options when ordered with G, L, M or Q contact material.

B contact material standard with all terminations.

K, L & M contact materials not available with Z & Z3 terminations.

E (STD.) EPOXY SEAL

