

Sound Processors for BOOM BOX / Mini-component Stereo

# Single Power Supply Sound Processors with Built-in Pre Amplifier for Tape Recording and Play Back (With Integrated 2-/3- band Equalizer)



BD3401KS2, BD3402KS2

No.10086EAT03

## ●Description

The Sound Processor with built-in record/play functions for cassette players, is suited for sound quality products such as, BOOM BOX, mini- and micro-audio systems. It incorporates various functions ranging from audio source selectors to preamplifiers at the front stage, preamplifier for cassette recording/playing, and a 2-wire serial bus.

## ●Features

- 1) Provides Surround and Bass Boost with the Soft-switching feature to reduce the shock sound at switching (BD3401KS2)
  - 2) Provides a specialized power supply terminal in a digital circuit, in order to set and maintain the state inside the IC by the minute stand-by current.
  - 3) Built-in preamplifier for cassette recording/playing allows for minimal external components, freeing up board space.
  - 4) Arranges all I/O terminals to a single point and allows easy PCB routing.
  - 5) Volume and Tone implemented with a resistance ladder circuit; achieving high performance with low noise and low distortion
  - 6) Energy-saving design resulting in low current consumption, by utilizing the BiCMOS process.
- It has the advantage in quality over the scaling down the power heat control of the internal regulators.

## ●Applications

BOOM BOX, mini-audio systems, and micro-audio systems.

## ●Product lineup

Parameter	BD3401KS2	BD3402KS2
Equalizer	3 band(BASS, MIDDLE, TREBLE)	2 band(BASS, TREBLE)
Volume	0 to -44dB/2dB step -44 to -76dB/4dB step, -∞dB	0 to -44dB/2dB step -44 to -76dB/4dB step, -∞dB
Cassette Recording/Playing Amplifier	○	○
Karaoke	○	-
Microphone Input	○	-
Subwoofer Output	○	-
Output for Spectrum Analyzer	○	-
Surround	○	-
Bass Boost	○	-
Package	SQFP-T64	SQFP-T64

## ●Absolute maximum ratings (Ta=25°C)

Items	Symbol	Ratings	Unit
Power Supply Voltage	Vcc	10	V
	Vdd	6	V
Power Dissipation	Pd	1200*	mW
Input Voltage Range	Vin	GND-0.3 to VCC+0.3	V
Operating Temperature Range	Topr	-25 to +75	°C
Storage Temperature Range	Tstg	-55 to +125	°C

\* Reduced by 12 mW/°C over 25°C, when installed on the standard board (size: 70 × 70 × 1.6mm).

## ●Operating voltage range

Device Name	Symbol	Range	Unit
BD3401KS2	Vcc	8 to 9.5	V
BD3402KS2	Vdd	3 to 5.5	

## ●Electrical characteristics

◎BD3401KS2

Ta=25°C, VCC=9V, VDD=5V, f=1kHz, Vi=1Vrms, RL=10kΩ, Rg=600Ω, INPUT SELECTOR=Ach, INPUT GAIN=0dB, VOLUME=0dB, TREBLE=0dB, BASS=0dB, MIDDLE=0dB, TONE ATT=0dB, MUX=STEREO, MIXING=OFF, MIXING GAIN=0dB, PLAY BACK=TAPE A, REC=OFF, LINE=OFF, MIC=OFF, BASS BOOST=OFF, SURROUND=OFF, AMS=OFF, ALC=OFF, INPUT=pin59,60, OUTPUT=pin32,33, unless otherwise noted.

	Parameter	Symbol	Limits			Unit	Conditions
			Min.	Typ.	Max.		
TOTAL	Circuit Current	IQ	-	35	50	mA	(No signal)
	Output Voltage Gain	Gv	-2	0	2	dB	INPUT GAIN=0dB
	Total Harmonic Distortion ratio	THDt	-	0.005	0.05	%	BW=400 to 30kHz OUT=pin32,33,53,54
	Maximum Output Voltage	Vomaxt	2.0	2.5	-	Vrms	THD=1%, BW=400 to 30kHz OUT=pin32,33,53,54
	Residual Noise Voltage*	Vr	-	1.8	6.0	μVrms	Rg=0Ω, Vol=-∞dB, BW=IHF-A,
	Output Noise Voltage*	Vno	-	3.0	9.0	μVrms	Rg=0Ω, Vol=0dB BW=IHF-A
	Cross-talk between Channels*	CTC	-	-80	-70	dB	Rg=0Ω, BW=IHF-A VOLOUT=1Vrms
	Cross-talk between Selectors*	CTS	-	-80	-70	dB	Rg=0Ω, BW=IHF-A
	Input Impedance	Rin	32	47	62	kΩ	Pin1 to 4, 59 to 64
MIXING	Total Harmonic Distortion ratio	THDmix	-	0.01	0.1	%	BW=400 to 30kHz, MIXING=ON INPUT SELECTOR=B
	Maximum Output Voltage	Vomaxmix	2.0	2.5	-	Vrms	THD=1%, BW=400 to 30kHz MIXING=ON INPUT SELECTOR=B
PLAYBACK	Output Voltage Gain	Gvp	23	25	27	dB	Vi=20mVrms, pin5-6, 7-8=short IN=pin9,10 OUT=pin6,7
	Total Harmonic Distortion ratio	THDp	-	0.01	0.1	%	Vi=20mVrms BW=400 to 30kHz pin5-6, 7-8=short IN=pin9,10 OUT=pin6,7
	Maximum Output Voltage	Vomaxp	2.0	2.5	-	Vrms	THD=1%, BW=400 to 30kHz pin5-6, 7-8=short IN=pin9,10 OUT=pin6,7
	Noise Voltage in input term*	Vnin	-	0.7	6.0	μVrms	Rg=0Ω, BW=IHF-A pin5-6, 7-8=short IN=pin9,10 OUT=pin6,7
	PB MUTE Amount	PBM	-	-	-70	dB	BW=IHF-A, pin5-6, 7-8=short IN=pin9,10 PLAY BACK=MUTE
REC	ALC Operation Level	ALC	0.5	0.7	0.9	Vrms	REC=ON ALC=ON
	Total Harmonic Distortion ratio	THDr	-	0.2	1	%	BW=400 to 30kHz OUT=pin14,15 REC=ON ALC=ON
	Output Noise Voltage*	Vnor	-	40	120	μVrms	Rg=0Ω, BW=IHF-A OUT=pin14,15 REC=ON ALC=ON

	Parameter	Symbol	Limits			Unit	Conditions
			Min	Typ.	Max		
MIC	Total Harmonic Distortion ratio	THDmic	-	0.01	0.1	%	BW=400 to 30kHz MIC=ON
	Maximum Output Voltage	V <sub>omaxmic</sub>	2.0	2.5	-	V <sub>rms</sub>	THD=1%, BW=400 to 30kHz MIC=ON
SPECTRUM ANALYZER	Spectrum Analyzer 1 Output Voltage Gain	Gvs1	-8	-6	-4	dB	OUTPUT=pin55
	Spectrum Analyzer 2 Output Voltage Gain	Gvs2	-2	0	2	dB	OUTPUT=pin56
SURROUND	Surround Gain	Gsur	4	6	8	dB	SURROUND=ON Vi=500mV <sub>rms</sub>
TREBLE	Treble Gain	Gt	-8 to +8(2dB/step)			dB	Vi=500mV <sub>rms</sub>
	Treble Gain Setting Error	TE	-2	0	2	dB	
MIDDLE	Middle Gain	Gm	-8 to +8(2dB/step)			dB	Vi=500mV <sub>rms</sub>
	Middle Gain Setting Error	ME	-2	0	-2	dB	
BASS	Bass Gain	Gb	-8 to +8(2dB/step)			dB	Vi=500mV <sub>rms</sub>
	Bass Gain Setting Error	BE	-2	0	-2	dB	
AMS	AMS EQ Gain	Gams	33	35	37	dB	OUTPUT=pin40 AMS=ON, Vi=20mV <sub>rms</sub>
VOLUME	Volume Setting Error 1	VE1	-2	0	2	dB	0 to -48dB, BW=IHF-A VOLOUT=1V <sub>rms</sub>
	Volume Setting Error 2	VE2	-3	0	3	dB	-52 to -76dB, BW=IHF-A VOLOUT=1V <sub>rms</sub>
	Maximum Attenuation*	Vmin	-	-	-90	dB	BW=IHF-A VOLOUT=1V <sub>rms</sub>
SUBWOOFER	Total Harmonic Distortion ratio	THDs	-	0.01	0.1	%	Vi=500mV <sub>rms</sub> BW=400 to 30kHz, OUT=pin25 No LPF
	Maximum Output Voltage	Vomaxs	1.5	2.0	2.5	V <sub>rms</sub>	THD=3%, BW=400 to 30kHz OUT=pin25, No LPF

©BD3402KS2

Ta=25°C, VCC=9V, VDD=5V, f=1kHz, Vi=1Vrms, RL=10kΩ, Rg=600Ω, INPUT SELECTOR=Ach, INPUT GAIN=0dB, VOLUME=0dB, TREBLE=0dB, BASS=0dB, TONE ATT=0dB, MUX=STEREO, MIXING=OFF, MIXING GAIN=0dB, REC=OFF, LINE=OFF, ALC=OFF INPUT=pin59,60, OUTPUT=pin32,33, unless otherwise noted.

	Parameter	Symbol	Limits			Unit	Conditions
			Min.	Typ.	Max.		
TOTAL	Circuit Current	IQ	-	28	50	mA	(No signal)
	Output Voltage Gain	Gv	-2	0	2	dB	INPUT GAIN=0dB
	Total Harmonic Distortion ratio	THDt	-	0.005	0.05	%	BW=400 to 30kHz OUT=pin32,33,53,54
	Maximum Output Voltage	Vomaxt	2.0	2.5	-	Vrms	THD=1%, BW=400 to 30kHz OUT=pin32,33,53,54
	Residual Noise Voltage*	Vr	-	1.5	5.0	μVrms	Rg=0Ω, Vol=-∞dB BW=IHF-A,
	Output Noise Voltage*	Vno	-	2.5	8.0	μVrms	Rg=0Ω, Vol=0dB BW=IHF-A
	Cross-talk between Channels*	CTC	-	-80	-70	dB	Rg=0Ω, BW=IHF-A VOLOUT=1Vrms
	Cross-talk between Selectors*	CTS	-	-80	-70	dB	Rg=0Ω, BW=IHF-A
	Input Impedance	Rin	32	47	62	kΩ	Pin1 to 4, 59 to 64
MIXING	Total Harmonic Distortion ratio	THDmix	-	0.01	0.1	%	BW=400 to 30kHz MIXING=ON INPUT SELECTOR=B
	Maximum Output Voltage	Vomaxmix	2.0	2.5	-	Vrms	THD=1%, BW=400 to 30kHz MIXING=ON INPUT SELECTOR=B
PLAYBACK	Output Voltage Gain	Gvp	23	25	27	dB	Vi=20mVrms pin5-6, 7-8=short IN=pin11,12 OUT=pin6,7
	Total Harmonic Distortion ratio	THDp	-	0.01	0.1	%	Vi=20mVrms BW=400 to 30kHz pin5-6, 7-8=short IN=pin11,12 OUT=pin6,7
	Maximum Output Voltage	Vomaxp	2.0	2.5	-	Vrms	THD=1%, BW=400 to 30kHz pin5-6, 7-8=short IN=pin11,12 OUT=pin6,7
	Noise Voltage in input term*	Vnin	-	0.7	6.0	μVrms	Rg=0Ω, BW=IHF-A pin5-6, 7-8=short IN=pin11,12 OUT=pin6,7
	PB MUTE Amount	PBM	-	-	-70	dB	BW=IHF-A, pin5-6, 7-8=short IN=pin11,12 PLAY BACK=MUTE
REC	ALC Operation Level	ALC	0.5	0.7	0.9	Vrms	REC=ON ALC=ON
	Total Harmonic Distortion ratio	THDr	-	0.2	1	%	BW=400 to 30kHz OUT=pin14,15 REC=ON, ALC=ON
	Output Noise Voltage*	Vnor	-	40	120	μVrms	Rg=0Ω, BW=IHF-A OUT=pin14,15 REC=ON, ALC=ON
TREBLE	Treble Gain	Gt	-8 to +8(2dB/step)			dB	Vi=500mVrms
	Treble Gain Setting Error	TE	-2	0	2	dB	
BASS	Bass Gain	Gb	-12 to +12(3dB/step)			dB	Vi=500mVrms
	Bass Gain Setting Error	BE	-2	0	-2	dB	
VOLUME	Volume Setting Error 1	VE1	-2	0	2	dB	0 to -48dB, BW=IHF-A VOLOUT=1Vrms
	Volume Setting Error 2	VE2	-3	0	3	dB	-52 to -76dB, BW=IHF-A VOLOUT=1Vrms
	Maximum Attenuation*	Vmin	-	-	-90	dB	BW=IHF-A VOLOUT=1Vrms

- \* For measurements marked with \*, VP-9690A (Average value wave detection, Effective value display) filter by Matsushita Communication Industrial is used.
- \* Phase relation between Input/Output signal terminals is the same (Inputs: pin59-64, pin1-4, Outputs: pin32, 33).
- \* This IC is not designed to be radiation-resistant.

●Control signal specifications

1. Signal Timing Conditions

- Data is read on the rising edge of the clock.
- Latch is read on the falling edge of the clock.
- Latch signal must terminate with the LOW state.
- To avoid malfunctions, clock and data signals must terminate with the LOW state.

1byte=8bit

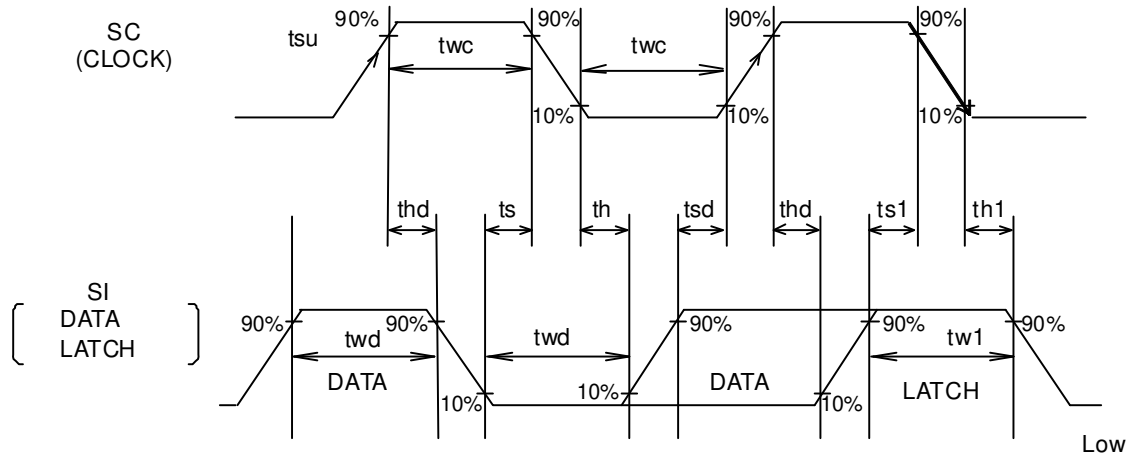

Fig.1

Parameter	Symbol	Limits			Unit
		Min	Typ.	Max	
Minimum Clock Width	twc	2.0	-	-	μS
Minimum Data Width	twd	2.0	-	-	μS
Minimum Latch Width	tw1	2.0	-	-	μS
Data Set-up Time (DATA→CLK)	tsd	1.0	-	-	μS
Data Hold Time (CLK→DATA)	thd	1.0	-	-	μS
Latch Set-up Time (CLK→LATCH)	ts1	1.0	-	-	μS
Latch Hold Time (DATA→LATCH)	th1	1.0	-	-	μS
Latch Low Set-up Time	ts	1.0	-	-	μS
Latch Low Hold Time	th	1.0	-	-	μS

2. Voltage Conditions for Control Signals

Parameter	Symbol	Limits			Unit
		Min	Typ.	Max	
“H” Input Voltage	Vcc=8 to 9.5V	2.2	-	5.5	V
“L” Input Voltage	Vcc=8 to 9.5V	0	-	1.0	V

●Control data format list

(BD3401KS2)

- Basic Configuration of Control Data Format

←Data input direction

	MSB							LSB
	D7	D6	D5	D4	D3	D2	D1	D0
Data	Data					Select Address		

- Control Data Formats

←Data input direction

	D7	D6	D5	D4	D3	D2	D1	D0
Data(1)	Input Selector			Input Gain		0	0	0
	D7	D6	D5	D4	D3	D2	D1	D0
Data(2)	Volume					0	0	1
	D7	D6	D5	D4	D3	D2	D1	D0
Data(3)	Treble				TONE ATT(1)	0	1	0
	D7	D6	D5	D4	D3	D2	D1	D0
Data(4)	Bass				TONE ATT(2)	0	1	1
	D7	D6	D5	D4	D3	D2	D1	D0
Data(5)	Middle				0	1	0	0
	D7	D6	D5	D4	D3			
Data(6)	Subwoofer Gain				1	1	0	0
	D7	D6	D5	D4	D3	D2	D1	D0
Data(7)	MUX		MIXING	MIXING GAIN		1	0	1
	D7	D6	D5	D4	D3	D2	D1	D0
Data(8)	PLAY BACK		REC	LINE	MIC	1	1	0
	D7	D6	D5	D4	D3	D2	D1	D0
Data(9)	Bass Boost	Surround	AMS	ALC	Vocal Fader	1	1	1

(BD3402KS2)

• Basic Configuration of Control Data Format

← Data input direction

	MSB							LSB
Data	D7	D6	D5	D4	D3	D2	D1	D0
	Data					Select Address		

• Control Data Formats

← Data input direction

Data(1)	D7	D6	D5	D4	D3	D2	D1	D0
	Input Selector			Input Gain		0	0	0
Data(2)	D7	D6	D5	D4	D3	D2	D1	D0
	Volume					0	0	1
Data(3)	D7	D6	D5	D4	D3	D2	D1	D0
	Treble				TONE ATT(1)	0	1	0
Data(4)	D7	D6	D5	D4	D3	D2	D1	D0
	Bass				TONE ATT(2)	0	1	1
Data(5)	D7	D6	D5	D4	D3	D2	D1	D0
	MUX		MIXING	MIXING GAIN		1	0	1
Data(6)	D7	D6	D5	D4	D3	D2	D1	D0
	*		REC	LINE	ALC	1	1	0

\* \* Indicates 0 or 1.

• By changing the setting of Select Address, nine different control formats are selectable.

• In every power-on sequence, all of the address data must be initialized.

Example:

← Data input direction

MSB	LSB	MSB	LSB	MSB	LSB	MSB	LSB	MSB	LSB	
Data(1)	L	Data(2)	L	Data(3)	L	Data(4)	L	...	Data(9)	L

"L" means a "latch."

• After power-on, for the second and subsequent times, only the necessary data can be selected for setting.

Example: When changing the volume,

← Data input direction

MSB	LSB
Data(2)	L

"L" means a "latch."

• TONE ATT settings

TONE ATT can be set to either one of three modes: 0dB, -4dB and -8dB using D3 in Data (3) or Data (4).

When setting TONE ATT, data should be sent as follows:

(1) TONE ATT=-4dB

(a) Sending Data (3) only

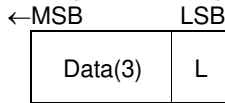

(b) Sending all the data

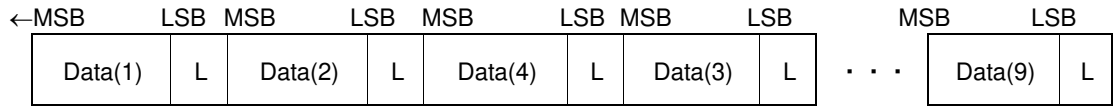

Sending Data(3) after Data(4) follows that Data(3) is given a higher priority.

(2) TONE ATT=-8dB

(a) Sending Data(4) only

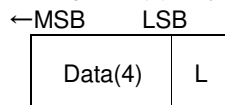

(b) Sending all the data

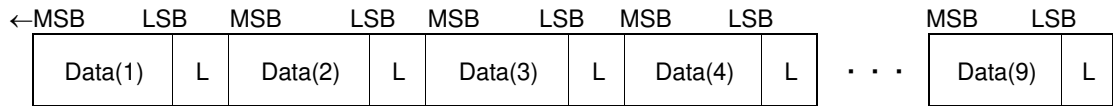

Sending Data(4) after Data(3) follows that Data(4) is given a higher priority.



## ● Pin description

(BD3401KS2)

Pin No.	Pin Name	Description	Pin No.	Pin Name	Description
1	D1	1ch input pin D	33	VOLOUT1	1ch output pin
2	D2	2ch input pin D	34	BBNF1	1ch bass boost filter setting pin
3	E1	1ch input pin E	35	BBIN1	1ch bass boost filter setting pin
4	E2	2ch input pin E	36	VIN1	1ch volume input pin
5	PBNF2	2ch PB filter setting pin	37	TONE OUT1	1ch tone output pin
6	PBOUT2	2ch PB output pin	38	VIN2	2ch volume input pin
7	PBOUT1	1ch PB output pin	39	TONE OUT2	2ch tone output pin
8	PBNF1	1ch PB filter setting pin	40	AMS OUT	AMS output pin
9	TAPE A1	1ch TAPE input pin A	41	BNF2	2ch bass filter setting pin
10	TAPE A2	2ch TAPE input pin A	42	BOUT2	2ch bass filter setting pin
11	TAPE B1	1ch TAPE input pin B	43	BOUT1	1ch bass filter setting pin
12	TAPE B2	2ch TAPE input pin B	44	BNF1	1ch bass filter setting pin
13	RECNF2	2ch REC filter setting pin	45	MNF1	1ch middle filter setting pin
14	RECOUT2	2ch REC output pin	46	MOUT1	1ch middle filter setting pin
15	RECOUT1	1ch REC output pin	47	MOUT2	2ch middle filter setting pin
16	RECNF1	1ch REC filter setting pin	48	MNF2	2ch middle filter setting pin
17	ALC	ALC time constant setting pin	49	TNF2	2ch treble filter setting pin
18	SC	Serial clock input pin	50	TNF1	1ch treble filter setting pin
19	SI	Serial data input pin	51	SUR1	Surround setting pin
20	VDD	Digital power supply pin	52	SUR2	Surround setting pin
21	GND	Ground pin	53	LINEOUT2	2ch LINE output pin
22	VCC	Analog power supply pin	54	LINEOUT1	1ch LINE output pin
23	1/2VCC	1/2VCC output pin	55	SAOUT2	Spectrum Analyzer output pin 2
24	FILTER	1/2 VCC pin	56	SAOUT1	Spectrum Analyzer output pin 1
25	SW OUT	Subwoofer output pin	57	CAP	Time constant setting pin for absorbing switching shock sound
26	LF4	Primary LPF setting pin	58	MIC	MIC input pin A
27	LF3	Secondary LPF setting pin	59	A1	1ch input pin A
28	LF2	Secondary LPF setting pin	60	A2	2ch input pin A
29	LF1	Secondary LPF setting pin	61	B1	1ch input pin B
30	BBIN2	2ch bass boost filter setting pin	62	B2	2ch input pin B
31	BBNF2	2ch bass boost filter setting pin	63	C1	1ch input pin C
32	VOL OUT2	2ch output pin	64	C2	2ch input pin C

● Block diagram, application circuit, pin assignment

(BD3401KS2)

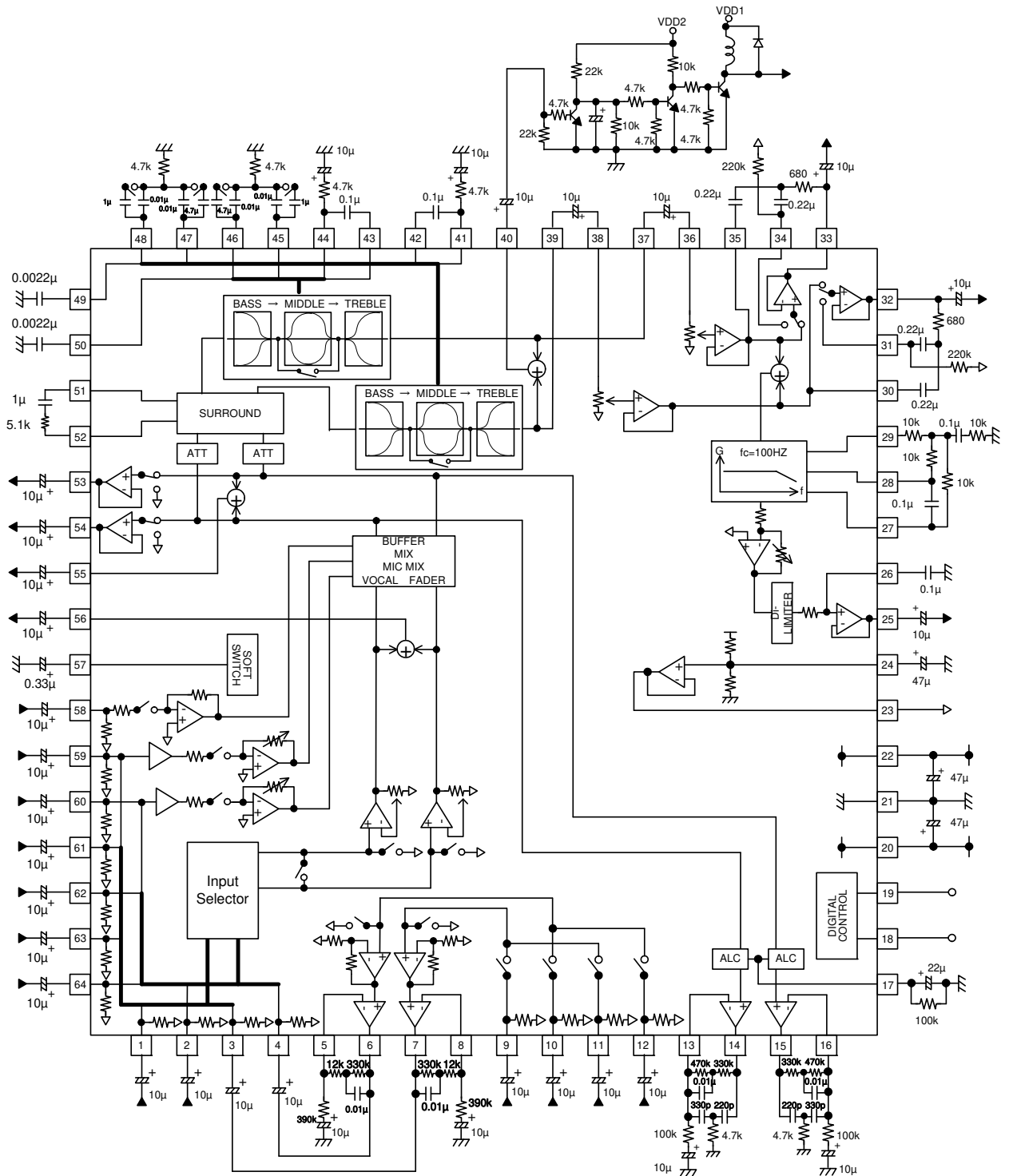

UNIT  
RESISTANCE : Ω  
CAPACITANCE : F

Fig.2

●Pin description  
(BD3402KS2)

Pin No.	Pin Name	Description	Pin No.	Pin Name	Description
1	D1	1ch input pin D	33	VOL OUT1	1ch output pin
2	D2	2ch input pin D	34	NC	Non Connection
3	E1	1ch input pin E	35	NC	Non Connection
4	E2	2ch input pin E	36	VIN1	1ch volume input pin
5	PBNF2	2ch PB filter setting pin	37	TONE OUT1	1ch tone output pin
6	PBOUT2	2ch PB output pin	38	VIN2	2ch volume input pin
7	PBOUT1	1ch PB output pin	39	TONE OUT2	2ch tone output pin
8	PBNF1	1ch PB filter setting pin	40	NC	Non Connection
9	NC	Non Connection	41	BNF2	2ch bass filter setting pin
10	NC	Non Connection	42	BOUT2	2ch bass filter setting pin
11	TAPE 1	1ch TAPE input pin	43	BOUT1	1ch bass filter setting pin
12	TAPE 2	2ch TAPE input pin	44	BNF1	1ch bass filter setting pin
13	RECNF2	2ch REC filter setting pin	45	NC	Non Connection
14	RECOUT2	2ch REC output pin	46	NC	Non Connection
15	RECOUT1	1ch REC output pin	47	NC	Non Connection
16	RECNF1	1ch REC filter setting pin	48	NC	Non Connection
17	ALC	ALC time constant setting pin	49	TNF2	2ch treble filter setting pin
18	SC	Serial clock input pin	50	TNF1	1ch treble filter setting pin
19	SI	Serial data input pin	51	NC	Non Connection
20	VDD	Digital power supply pin	52	NC	Non Connection
21	GND	Ground pin	53	LINEOUT2	2chLINE output pin
22	VCC	Analog power supply pin	54	LINEOUT1	1chLINE output pin
23	NC	Non Connection	55	NC	Non Connection
24	FILTER	1/2 VCC pin	56	NC	Non Connection
25	NC	Non Connection	57	NC	Non Connection
26	NC	Non Connection	58	NC	Non Connection
27	NC	Non Connection	59	A1	1ch input pin A
28	NC	Non Connection	60	A2	2ch input pin A
29	NC	Non Connection	61	B1	1ch input pin B
30	NC	Non Connection	62	B2	2ch input pin B
31	NC	Non Connection	63	C1	1ch input pin C
32	VOL OUT2	2ch output pin	64	C2	2ch input pin C

● Block diagram, application circuit, pin assignment

(BD3402KS2)

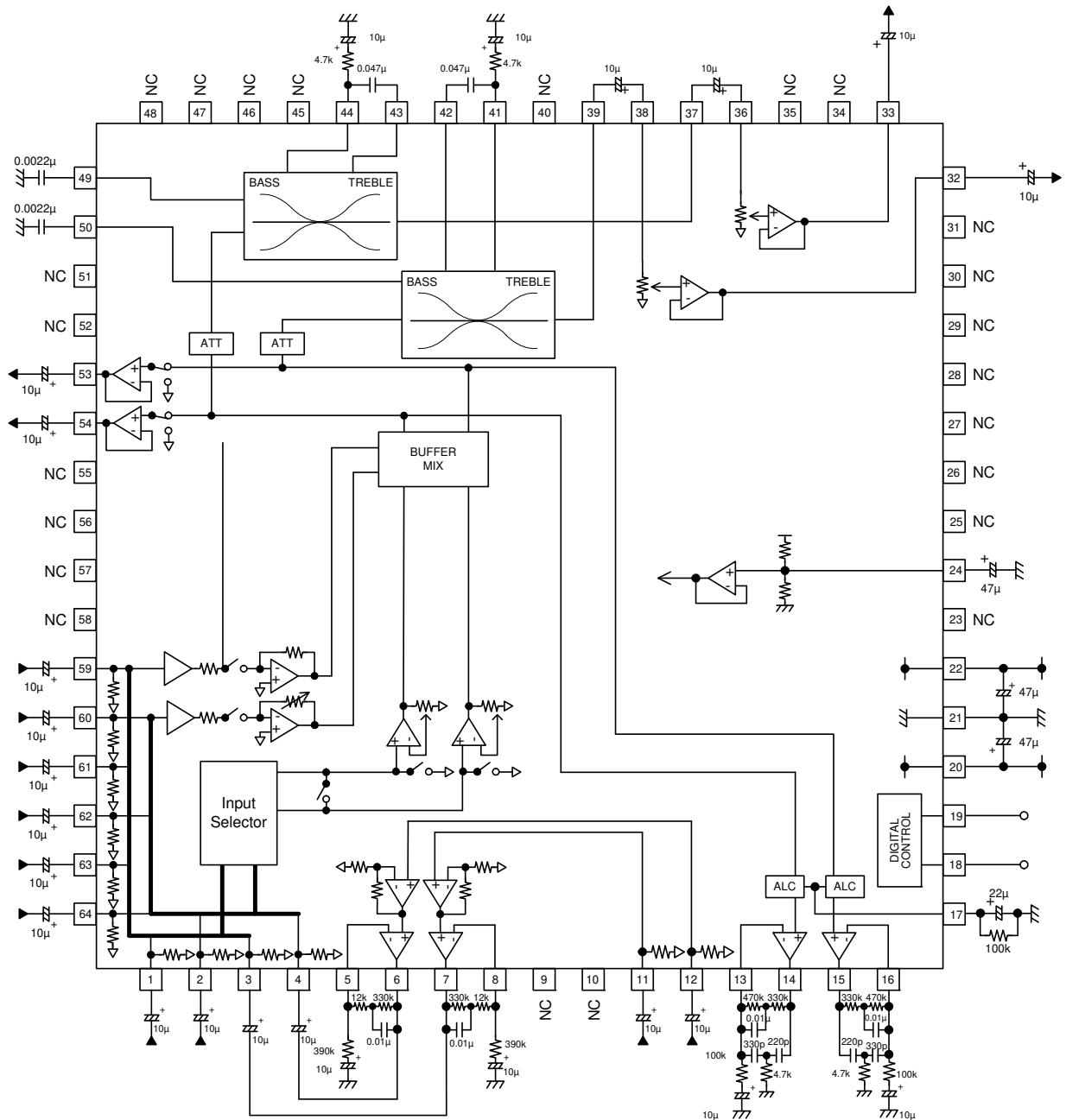

UNIT  
RESISTANCE : Ω  
CAPACITANCE : F

Fig.3

● Reference data

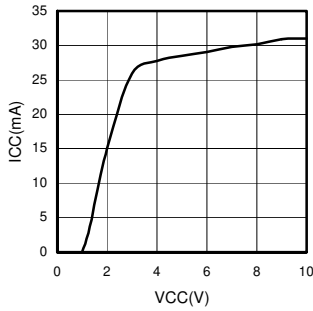

Fig.4 Circuit Current - Supply Voltage (BD3401KS2)

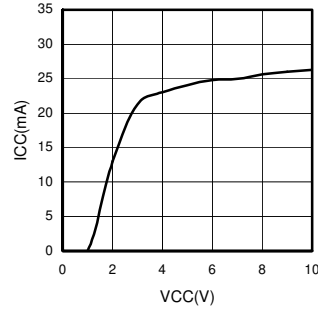

Fig.5 Circuit Current - Supply Voltage (BD3402KS2)

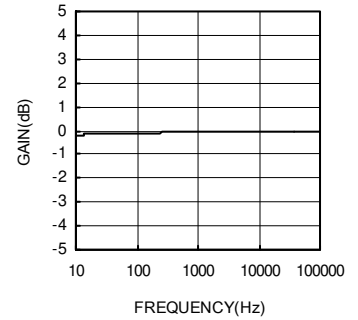

Fig.6 Voltage Gain - Frequency

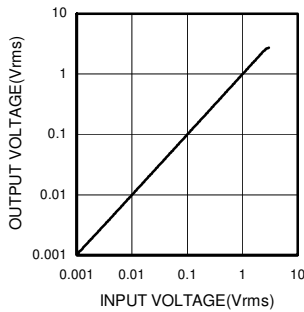

Fig.7 Output Voltage - Input Voltage

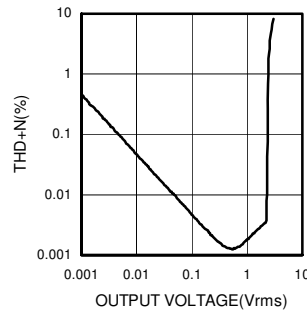

Fig.8 Total Harmonic Distortion ratio - Output Voltage

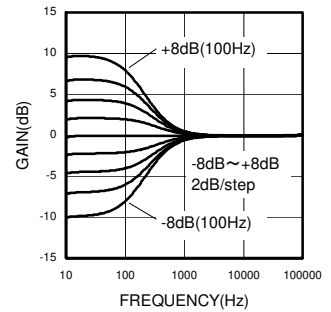

Fig.9 Bass Gain - Frequency (BD3401KS2)

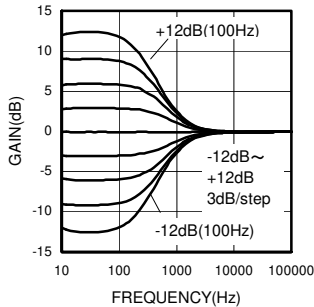

Fig.10 Bass Gain - Frequency (BD3402KS2)

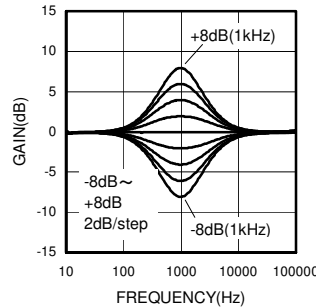

Fig.11 Middle Gain - Frequency (BD3401KS2)

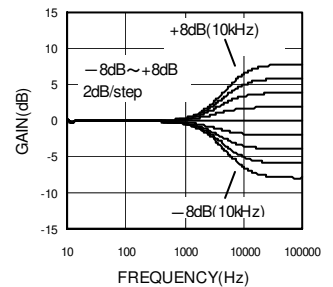

Fig.12 Treble Gain - Frequency

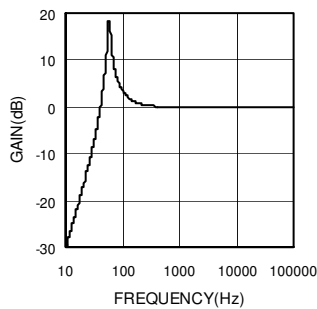

Fig.13 Bass Boost Gain - Frequency (BD3401KS2)

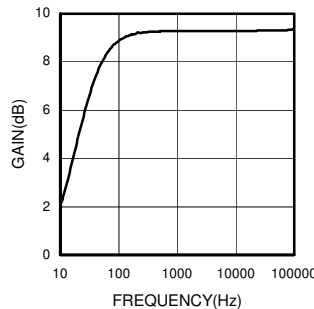

Fig.14 Surround Gain - Frequency (BD3401KS2)

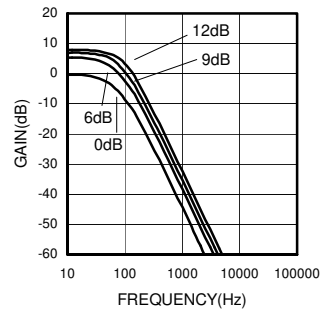

Fig.15 Subwoofer Gain - Frequency (BD3401KS2)

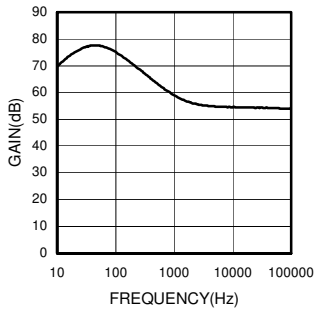

Fig.16 Amp Gain - Frequency (PB)

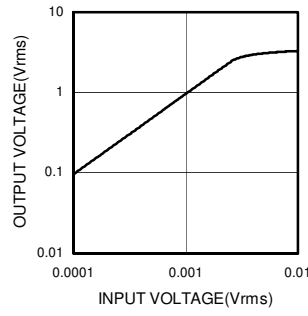

Fig.17 Output Voltage - Input Voltage (PB)

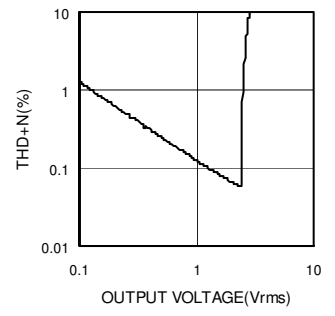

Fig.18 Total Harmonic Distortion ratio - Output Voltage (PB)

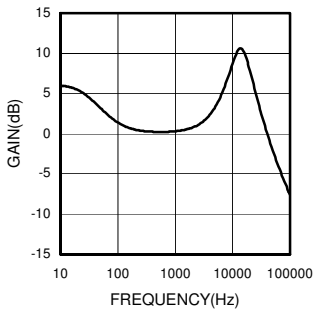

Fig.19 Amp Gain - Frequency (REC)

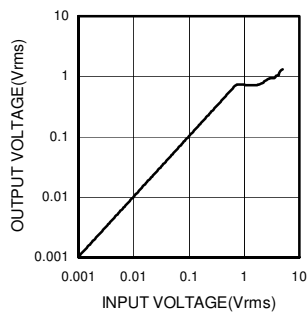

Fig.20 Output Voltage - Input Voltage (REC)

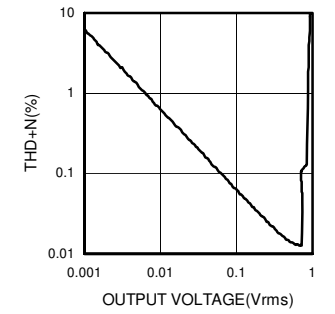

Fig.21 Total Harmonic Distortion ratio - Output Voltage (REC)

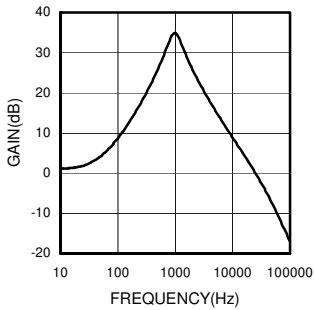

Fig.22 AMS Gain - Frequency (BD3401KS2)

●Notes for use

- 1) Numbers and data in entries are representative design values and are not guaranteed values of the items.
- 2) Although ROHM is confident that the example application circuit reflects the best possible recommendations, be sure to verify circuit characteristics for your particular application. Modification of constants for other externally connected circuits may cause variations in both static and transient characteristics for external components as well as this Rohm IC. Allow for sufficient margins when determining circuit constants.
- 3) Absolute maximum ratings  
Use of the IC in excess of absolute maximum ratings, such as the applied voltage or operating temperature range (Topr), may result in IC damage. Assumptions should not be made regarding the state of the IC (short mode or open mode) when such damage is suffered. A physical safety measure, such as a fuse, should be implemented when using the IC at times where the absolute maximum ratings may be exceeded.
- 4) GND potential  
Ensure a minimum GND pin potential in all operating conditions. Make sure that no pins are at a voltage below the GND at any time, regardless of whether it is a transient signal or not.
- 5) Thermal design  
Perform thermal design, in which there are adequate margins, by taking into account the permissible dissipation (Pd) in actual states of use.
- 6) Short circuit between terminals and erroneous mounting  
Pay attention to the assembly direction of the ICs. Wrong mounting direction or shorts between terminals, GND, or other components on the circuits, can damage the IC.
- 7) Operation in strong electromagnetic field  
Using the ICs in a strong electromagnetic field can cause operation malfunction.
- 8) Serial control  
For the SC and SI terminals, the wiring and layout patterns should be routed as not to cause interference with the analog-signal-related lines.
- 9) Power ON/OFF  
At power ON/OFF, a shock sound will be generated and, therefore, MUTE shall be applied.
- 10) Start-up sequence of the power supplies  
VDD and VCC should be turned on simultaneously or VDD first, followed by VCC.
- 11) Function switching  
(BD3401KS2)  
For all functions except Master Volume, Treble, Middle, Bass, Surround, and Bass Boost, MUTE must be applied during setup.  
(BD3402KS2)  
For all the functions except Master Volume, Treble and Bass, MUTE must be applied during setup..
- 12) Power-ON Reset  
A built-in circuit for performing initialization inside the IC at power-ON is provided. In unstable systems it is recommended that the data shall be sent to all the addresses during power-ON, until this operation cycle is completed. Mute should be applied during this cycle.

Function	Initial State	BD3401KS2	BD3402KS2
Input Selector	MUTE	○	○
Input Gain	-5dB	○	○
Volume	0dB	○	○
Treble	0dB	○	○
Bass	0dB	○	○
Middle	0dB	○	-
TONE ATT	0dB	○	○
Subwoofer	0dB	○	-
MUX	STEREO	○	○
Mixing	OFF	○	○
Mixing Gain	3dB	○	○
PLAY BACK	TAPE A	○	No selector
REC	OFF	○	○
LINE	OFF	○	○
MIC	OFF	○	-
Bass Boost	OFF	○	-
Surround	OFF	○	-
AMS	OFF	○	-
ALC	OFF	○	○
Vocal Fader	OFF	○	-

13) Constraints of serial control

- (1) On soft-switching of the BASS BOOST, SURROUND and AMS functions, data must not be serially sent to the functions involved before the switching operation is completed.  
Data (1) to (8) can be serially sent immediately after sending Data (9).

For functions that need to use soft-switch, data (Data (9)) can be serially sent on the same select address.

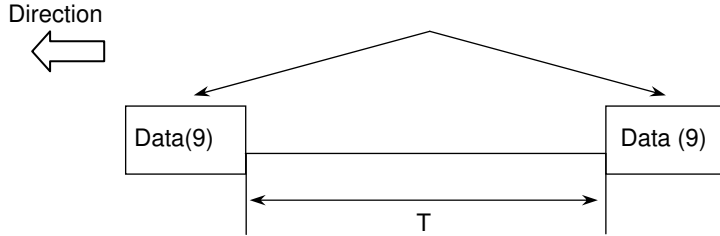

The time interval: T(sec) between Data (9) must be set to have a sufficient delay time. For example, 100ms or more when C on pin57 is 0.33μF.

Fig.23

- (2) When switching AMS ON and OFF, a shock sound will be generated. Using MUTE provided on VOLUME, control data should be sent in order to avoid outputting the shock sound from VOLOUT1,2 (pin32,33) as described in the figure below:

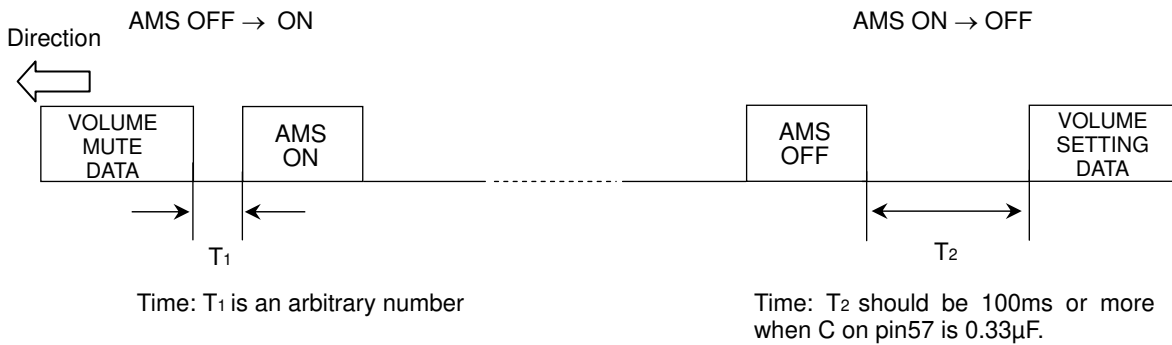

Time: T<sub>1</sub> is an arbitrary number

Time: T<sub>2</sub> should be 100ms or more when C on pin57 is 0.33μF.

Fig.24



• Thermal derating characteristic

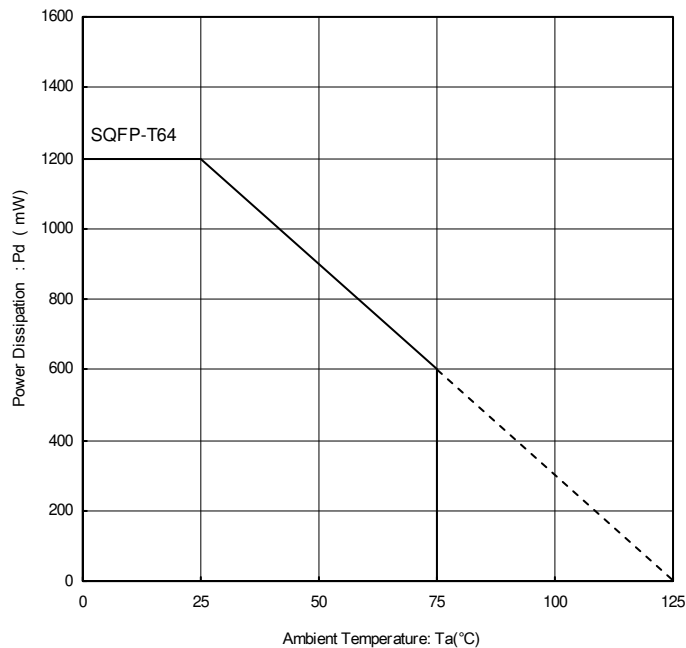

When installed on the ROHM standard board  
(size: 70 × 70 × 1.6mm, Glass epoxy board)

Fig.25

●Ordering part number

B	D
---	---

Part No.

3	4	0	1
---	---	---	---

Part No.  
3401,3402

K	S	2
---	---	---

Package  
KS2: SQFP-T64

--	--

Packaging and forming specification  
None: Tray

SQFP-T64

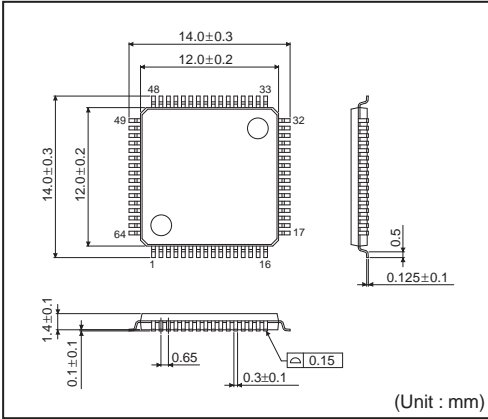

<Tape and Reel information>

Container	Tray (with dry pack)
Quantity	1000pcs
Direction of feed	Direction of product is fixed in a tray

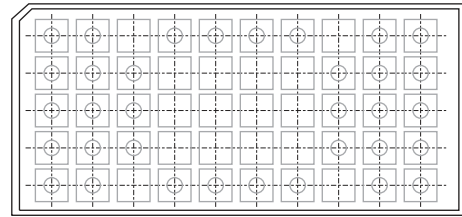
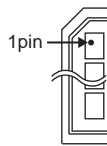

\*Order quantity needs to be multiple of the minimum quantity.

# Notice

## Precaution on using ROHM Products

- Our Products are designed and manufactured for application in ordinary electronic equipments (such as AV equipment, OA equipment, telecommunication equipment, home electronic appliances, amusement equipment, etc.). If you intend to use our Products in devices requiring extremely high reliability (such as medical equipment <sup>(Note 1)</sup>, transport equipment, traffic equipment, aircraft/spacecraft, nuclear power controllers, fuel controllers, car equipment including car accessories, safety devices, etc.) and whose malfunction or failure may cause loss of human life, bodily injury or serious damage to property ("Specific Applications"), please consult with the ROHM sales representative in advance. Unless otherwise agreed in writing by ROHM in advance, ROHM shall not be in any way responsible or liable for any damages, expenses or losses incurred by you or third parties arising from the use of any ROHM's Products for Specific Applications.

(Note1) Medical Equipment Classification of the Specific Applications

JAPAN	USA	EU	CHINA
CLASS III	CLASS III	CLASS II b	CLASS III
CLASS IV		CLASS III	

- ROHM designs and manufactures its Products subject to strict quality control system. However, semiconductor products can fail or malfunction at a certain rate. Please be sure to implement, at your own responsibilities, adequate safety measures including but not limited to fail-safe design against the physical injury, damage to any property, which a failure or malfunction of our Products may cause. The following are examples of safety measures:
  - Installation of protection circuits or other protective devices to improve system safety
  - Installation of redundant circuits to reduce the impact of single or multiple circuit failure
- Our Products are designed and manufactured for use under standard conditions and not under any special or extraordinary environments or conditions, as exemplified below. Accordingly, ROHM shall not be in any way responsible or liable for any damages, expenses or losses arising from the use of any ROHM's Products under any special or extraordinary environments or conditions. If you intend to use our Products under any special or extraordinary environments or conditions (as exemplified below), your independent verification and confirmation of product performance, reliability, etc. prior to use, must be necessary:
  - Use of our Products in any types of liquid, including water, oils, chemicals, and organic solvents
  - Use of our Products outdoors or in places where the Products are exposed to direct sunlight or dust
  - Use of our Products in places where the Products are exposed to sea wind or corrosive gases, including Cl<sub>2</sub>, H<sub>2</sub>S, NH<sub>3</sub>, SO<sub>2</sub>, and NO<sub>2</sub>
  - Use of our Products in places where the Products are exposed to static electricity or electromagnetic waves
  - Use of our Products in proximity to heat-producing components, plastic cords, or other flammable items
  - Sealing or coating our Products with resin or other coating materials
  - Use of our Products without cleaning residue of flux (even if you use no-clean type fluxes, cleaning residue of flux is recommended); or Washing our Products by using water or water-soluble cleaning agents for cleaning residue after soldering
  - Use of the Products in places subject to dew condensation
- The Products are not subject to radiation-proof design.
- Please verify and confirm characteristics of the final or mounted products in using the Products.
- In particular, if a transient load (a large amount of load applied in a short period of time, such as pulse. is applied, confirmation of performance characteristics after on-board mounting is strongly recommended. Avoid applying power exceeding normal rated power; exceeding the power rating under steady-state loading condition may negatively affect product performance and reliability.
- De-rate Power Dissipation (Pd) depending on Ambient temperature (Ta). When used in sealed area, confirm the actual ambient temperature.
- Confirm that operation temperature is within the specified range described in the product specification.
- ROHM shall not be in any way responsible or liable for failure induced under deviant condition from what is defined in this document.

## Precaution for Mounting / Circuit board design

- When a highly active halogenous (chlorine, bromine, etc.) flux is used, the residue of flux may negatively affect product performance and reliability.
- In principle, the reflow soldering method must be used; if flow soldering method is preferred, please consult with the ROHM representative in advance.

For details, please refer to ROHM Mounting specification

### Precautions Regarding Application Examples and External Circuits

1. If change is made to the constant of an external circuit, please allow a sufficient margin considering variations of the characteristics of the Products and external components, including transient characteristics, as well as static characteristics.
2. You agree that application notes, reference designs, and associated data and information contained in this document are presented only as guidance for Products use. Therefore, in case you use such information, you are solely responsible for it and you must exercise your own independent verification and judgment in the use of such information contained in this document. ROHM shall not be in any way responsible or liable for any damages, expenses or losses incurred by you or third parties arising from the use of such information.

### Precaution for Electrostatic

This Product is electrostatic sensitive product, which may be damaged due to electrostatic discharge. Please take proper caution in your manufacturing process and storage so that voltage exceeding the Products maximum rating will not be applied to Products. Please take special care under dry condition (e.g. Grounding of human body / equipment / solder iron, isolation from charged objects, setting of Ionizer, friction prevention and temperature / humidity control).

### Precaution for Storage / Transportation

1. Product performance and soldered connections may deteriorate if the Products are stored in the places where:
  - [a] the Products are exposed to sea winds or corrosive gases, including Cl<sub>2</sub>, H<sub>2</sub>S, NH<sub>3</sub>, SO<sub>2</sub>, and NO<sub>2</sub>
  - [b] the temperature or humidity exceeds those recommended by ROHM
  - [c] the Products are exposed to direct sunshine or condensation
  - [d] the Products are exposed to high Electrostatic
2. Even under ROHM recommended storage condition, solderability of products out of recommended storage time period may be degraded. It is strongly recommended to confirm solderability before using Products of which storage time is exceeding the recommended storage time period.
3. Store / transport cartons in the correct direction, which is indicated on a carton with a symbol. Otherwise bent leads may occur due to excessive stress applied when dropping of a carton.
4. Use Products within the specified time after opening a humidity barrier bag. Baking is required before using Products of which storage time is exceeding the recommended storage time period.

### Precaution for Product Label

QR code printed on ROHM Products label is for ROHM's internal use only.

### Precaution for Disposition

When disposing Products please dispose them properly using an authorized industry waste company.

### Precaution for Foreign Exchange and Foreign Trade act

Since our Products might fall under controlled goods prescribed by the applicable foreign exchange and foreign trade act, please consult with ROHM representative in case of export.

### Precaution Regarding Intellectual Property Rights

1. All information and data including but not limited to application example contained in this document is for reference only. ROHM does not warrant that foregoing information or data will not infringe any intellectual property rights or any other rights of any third party regarding such information or data. ROHM shall not be in any way responsible or liable for infringement of any intellectual property rights or other damages arising from use of such information or data.:
2. No license, expressly or implied, is granted hereby under any intellectual property rights or other rights of ROHM or any third parties with respect to the information contained in this document.

### Other Precaution

1. This document may not be reprinted or reproduced, in whole or in part, without prior written consent of ROHM.
2. The Products may not be disassembled, converted, modified, reproduced or otherwise changed without prior written consent of ROHM.
3. In no event shall you use in any way whatsoever the Products and the related technical information contained in the Products or this document for any military purposes, including but not limited to, the development of mass-destruction weapons.
4. The proper names of companies or products described in this document are trademarks or registered trademarks of ROHM, its affiliated companies or third parties.

**General Precaution**

1. Before you use our Products, you are requested to carefully read this document and fully understand its contents. ROHM shall not be in any way responsible or liable for failure, malfunction or accident arising from the use of any ROHM's Products against warning, caution or note contained in this document.
2. All information contained in this document is current as of the issuing date and subject to change without any prior notice. Before purchasing or using ROHM's Products, please confirm the latest information with a ROHM sales representative.
3. The information contained in this document is provided on an "as is" basis and ROHM does not warrant that all information contained in this document is accurate and/or error-free. ROHM shall not be in any way responsible or liable for any damages, expenses or losses incurred by you or third parties resulting from inaccuracy or errors of or concerning such information.