

THIS DRAWING IS UNPUBLISHED. RELEASED FOR PUBLICATION 20  
 © COPYRIGHT20 BY - ALL RIGHTS RESERVED.

LOC	DIST	REVISIONS			
P	LTR	DESCRIPTION	DATE	DWN	APVD
AP	-				
	G2	REVISED BY ECO 14-010612	28JUL2014	HC	WLS
	G3	REV. BY ECO 16-010419	14JULY2016	HC	WLS
	-	-	-	-	-
	-	-	-	-	-

**CAD**  
**Pro-E**  
 DO NOT REVISE  
 EXCEPT BY CAD

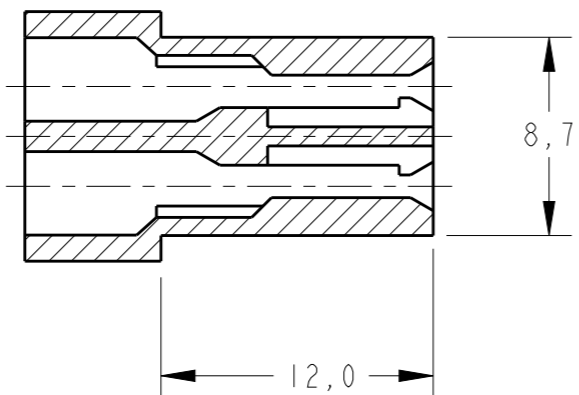
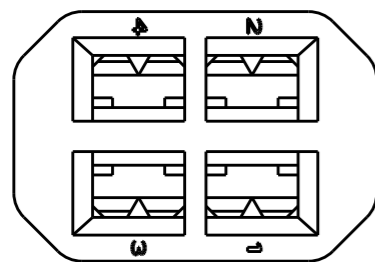

SECTION A-A

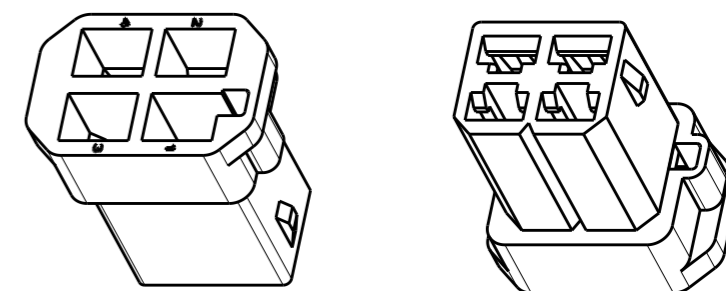
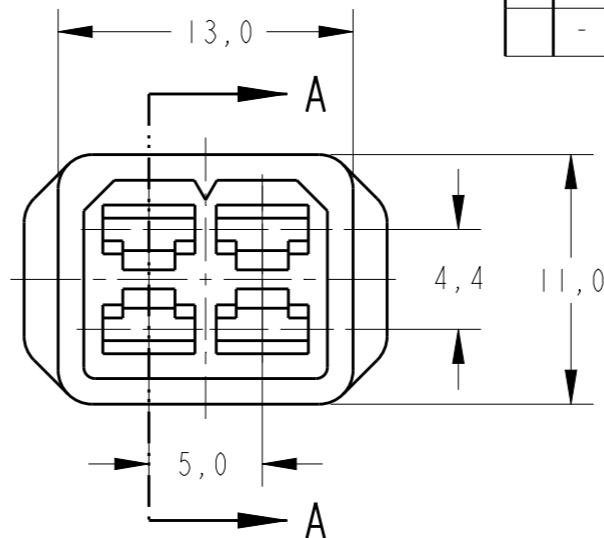

PERSPECTIVE VIEW  
 SCALE 2:1

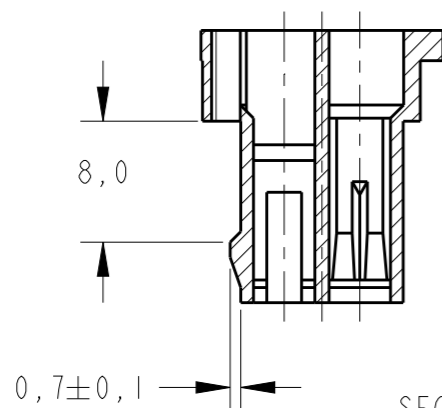

SECTION B-B

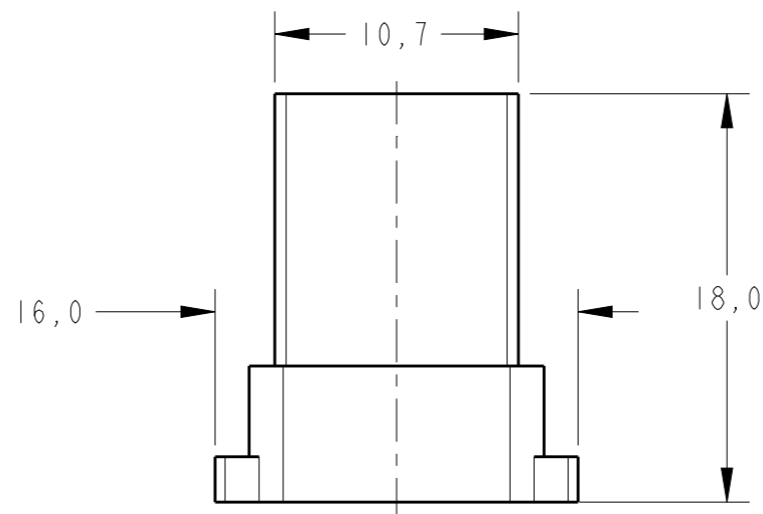

RAW MAT'L NO	FINISH	MATERIAL	PART NUMBER
—	RED	PA4.6 (HIGH TEMPERATURE)	626056-5
—	PRETO/BLACK	PA4.6 (HIGH TEMPERATURE)	626056-4
OBSOLETE	PRETO/BLACK	P.A. 6.6	626056-3
—	NATURAL	P.A. 6.6	626056-2
OBSOLETE	PRETO/BLACK	P.A. 6.6	626056-1
—	NATURAL	P.A. 6.6	626056-0

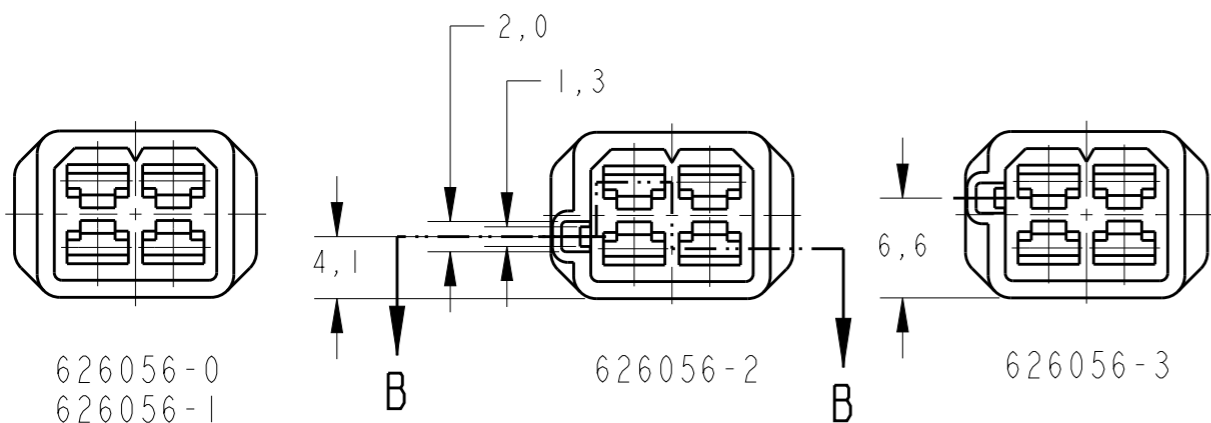

DETAILS FOR POLARIZATION

THIS DRAWING IS A CONTROLLED DOCUMENT.

DIMENSIONS: mm	TOLERANCES UNLESS OTHERWISE SPECIFIED: 0 PLC ± 1 PLC ± 2 PLC ±0,3 3 PLC ± 4 PLC ± ANGLES ±	DWN F.S.MARTINS 17JUN99 CHK P.L.FARIA 28JUN99 APVD J.M.M.NETO 28JUN99	 TE Connectivity NAME HOUSING 4P .110 FASTIN-ON REC.
MATERIAL -	FINISH -	PRODUCT SPEC - APPLICATION SPEC - WEIGHT -	

Customer Drawing SCALE 3:1 SHEET 1 OF 1 REV G3