

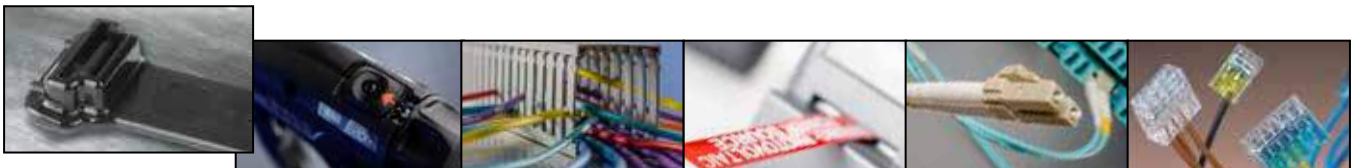

MOC and LOC Routing Clips and Clamps

For Fluid System Applications



## Endless ways to route fluid systems with a single solution? Go configure.

Versatile. Secure. That's MOC. HellermannTyton's comprehensive family of tube and pipe routing clips means unlimited possibilities for auto, truck and heavy equipment manufacturers.

Our patented design results in superior retention, preventing inadvertent disengagement under vibration and during assembly processes such as vacuum fill. Yet, these products quickly and easily attach to routings to help installers maintain high productivity.

That's why our engineers developed hundreds of modular configurations for our open clips and locking clamps. With 12 different product designs and numerous size combinations, these fasteners break free of traditional routing limitations, helping you get a custom-like solution right off the shelf.

Of course, there's always room for a new configuration in the event your unique application warrants it. Need to add a third or fourth clip or a different mount? Let's work together to route your tubes and wiring in the most efficient and effective way possible.

- Ideal for fuel, brake, vacuum, venting, cable and harness, HVAC and powertrain thermal management applications.
- Available in impact modified, heat and UV stabilized PA66 for long-term durability as well as high-heat and high-strength options.
- Cable tie option provides the widest range of diameter adjustments up to 50 mm.
- Locking clamps add the assurance of a 360-degree locking enclosure.



Retaining legs resist direction of bundle disengagement.

Small gap prevents tube from disengaging under vacuum fill.

Patented added retention feature on sizes 10 mm and above holds tube securely and provides the first level of resistance from disengagement.

# Bundling and Securing

## MOC & LOC Bundle Sizing\*

These are recommended size ranges for all clips and clamps. Recommended sizes may differ depending on the application, product requirements and materials used. If in doubt, please request samples of multiple sizes from your sales manager.

MOC Type	Pipe, Hard Tube/ Hose, Cable		Soft Tube / Hose		Harness	
	MIN dia. mm	MAX dia. mm	MIN dia. mm	MAX dia. mm	MIN dia. mm	MAX dia. mm
MOC5	4.8	5.5	4.0	5.3	4.5	5.5
MOC6	6.0	6.8	5.5	6.5	5.5	6.5
MOC7	7.0	8.0	6.0	7.5	6.5	7.5
MOC8	7.9	9.0	7.0	8.5	7.5	8.5
MOC9	9.0	10.0	8.0	10.0	8.5	10.0
MOC10	10.0	11.5	9.5	11.5	10.0	11.5
MOC12	12.0	13.8	10.5	13.0	11.5	13.0
MOC14	14.0	15.8	13.0	15.0	13.0	15.0
MOC16	15.9	18.3	14.0	17.0	14.0	17.0
MOC19	19.0	21.8	17.0	20.0	17.0	20.0
MOC22	22.0	25.0	20.0	24.0	20.0	24.0
MOC26	25.9	29.0	23.0	28.5	24.5	28.5

LOC Type	Pipe, Hard Tube/ Hose, Cable		Soft Tube / Hose		Harness	
	MIN dia. mm	MAX dia. mm	MIN dia. mm	MAX dia. mm	MIN dia. mm	MAX dia. mm
LOC5-9	7.0	10.0	5.0	10.0	5.0	10.0
LOC10-14	11.0	15.0	10.0	15.0	10.0	15.0
LOC15-19	16.0	20.0	15.0	20.0	15.0	20.0
LOC20-25	21.0	25.0	20.0	25.0	20.0	25.0
Tie Type	MIN dia. mm	MAX dia. mm	MIN dia. mm	MAX dia. mm	MIN dia. mm	MAX dia. mm
T50R	4.0	50.0	4.0	50.0	4.0	50.0
T50SVC	2.0	35.0	2.0	35.0	2.0	35.0
T50SMVC	2.0	50.0	2.0	50.0	2.0	50.0

FT Type	Min Panel mm	Max Panel mm	Min Hole Ø mm	Max Hole Ø mm
FT6.5	0.6	5.5	6.1	6.9

FT Type	Min Panel mm	Max Panel mm	Slot 1 mm	Slot 2 mm	Slot 3 mm	Slot 4 mm
FTOVAL	0.6	5.5	6.2x12.2	6.5x12.5	6.5x12	7x13

\*Recommended sizes may differ depending on the application, product requirements and materials used.

# Bundling and Securing

## Bundle Separators

### MOC Clips to MOC Clips

#### MOC to MOC

Rotatable dual routing clips keep two routings secured and separated. A swivel coupler allows them to rotate independently of each other.

#### Features and Benefits

- Patented retention design features inverted retaining legs, narrow opening and circular retainer to prevent inadvertent disengagement.
- Controlled flex and angled entry promote easy installation.
- Independent rotation allows for adjustable routing orientation.



<b>MATERIAL</b>	Polyamide 6.6 high impact modified, heat and UV stabilized (PA66HIRHSUV)
<b>Operating Temperature</b>	-40°F to +230°F (-40°C to +110°C)
<b>Flammability</b>	UL 94 HB

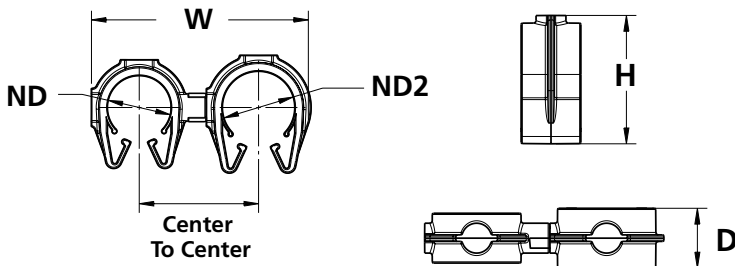

HF ✓

RoHS ✓

PART NO.	TYPE	Nominal Clip Diameter (ND) mm	Nominal Clip Dia. 2 (ND2) mm	Width (W) mm	Height (H) mm	Depth (D) mm	Center to Center mm	Drawing
156-02280	MOC5FMOC5M	5.0	5.0	24.1	10.8	10.0	14.8	
156-02281	MOC5FMOC6M	5.0	6.0	25.8	12.0	10.0	15.5	
156-02282	MOC5FMOC7M	5.0	7.0	26.3	13.4	10.0	16.0	
156-02283	MOC5FMOC8M	5.0	8.0	27.9	15.2	10.0	16.8	
156-02284	MOC5FMOC9M	5.0	9.0	29.7	17.2	10.0	17.4	
156-02285	MOC5FMOC10M	5.0	10.0	31.7	19.6	10.0	18.4	
156-02286	MOC5FMOC12M	5.0	12.0	33.6	22.1	10.0	19.3	
156-02287	MOC5FMOC14M	5.0	14.0	35.7	23.8	10.0	20.4	
156-02288	MOC5FMOC16M	5.0	16.0	37.7	25.7	12.0	21.3	
156-02289	MOC5FMOC19M	5.0	19.0	42.0	32.8	12.0	23.4	
156-02290	MOC5FMOC22M	5.0	22.0	45.2	36.5	12.0	24.9	
156-02292	MOC5FMOC26M	5.0	26.0	49.3	41.0	12.0	26.9	
156-02293	MOC6FMOC6M	6.0	6.0	27.2	12.0	10.0	16.1	
156-02294	MOC6FMOC7M	6.0	7.0	27.6	13.4	10.0	16.5	
156-02295	MOC6FMOC8M	6.0	8.0	29.2	15.2	10.0	17.4	
156-02296	MOC6FMOC9M	6.0	9.0	31.0	17.2	10.0	17.9	

Dimensions are approximate and subject to technical changes. Use Part No. for ordering and Type for specification purposes.

### MOC Clips to MOC Clips

#### MOC to MOC

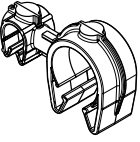
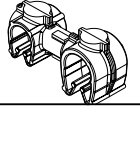
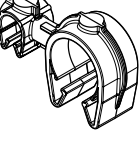
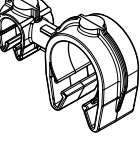
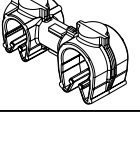
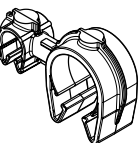
PART NO.	TYPE	Nominal Clip Diameter (ND) mm	Nominal Clip Dia. 2 (ND2) mm	Width (W) mm	Height (H) mm	Depth (D) mm	Center to Center mm	Drawing
156-02297	MOC6FMOC10M	6.0	10.0	33.0	19.6	10.0	18.9	
156-02298	MOC6FMOC12M	6.0	12.0	34.9	22.1	10.0	19.8	
156-02299	MOC6FMOC14M	6.0	14.0	36.5	23.8	10.0	20.9	
156-02300	MOC6FMOC16M	6.0	16.0	39.0	25.7	12.0	21.9	
156-02301	MOC6FMOC19M	6.0	19.0	43.3	32.8	12.0	24.0	
156-02302	MOC6FMOC22M	6.0	22.0	46.5	36.5	12.0	25.5	
156-02304	MOC6FMOC26M	6.0	26.0	50.6	41.0	12.0	27.5	
156-02305	MOC7FMOC7M	7.0	7.0	28.6	13.4	10.0	17.0	
156-02306	MOC7FMOC8M	7.0	8.0	30.2	15.2	10.0	17.9	
156-02307	MOC7FMOC9M	7.0	9.0	31.7	17.2	10.0	18.2	
156-02308	MOC7FMOC10M	7.0	10.0	33.9	19.6	10.0	19.4	
156-02309	MOC7FMOC12M	7.0	12.0	35.9	22.1	10.0	20.3	
156-02310	MOC7FMOC14M	7.0	14.0	37.5	23.8	10.0	21.4	
156-02311	MOC7FMOC16M	7.0	16.0	39.3	25.7	12.0	22.4	
156-02312	MOC7FMOC19M	7.0	19.0	44.3	32.8	12.0	24.5	
156-02313	MOC7FMOC22M	7.0	22.0	47.5	36.5	12.0	26.0	
156-02315	MOC7FMOC26M	7.0	26.0	51.5	41.0	12.0	28.0	
156-02316	MOC8FMOC8M	8.0	8.0	31.5	15.2	10.0	18.3	
156-02317	MOC8FMOC9M	8.0	9.0	33.3	17.2	10.0	18.9	
156-02318	MOC8FMOC10M	8.0	10.0	35.3	19.6	10.0	19.9	
156-01666	MOC8FMOC12M	8.0	12.0	37.2	22.1	10.0	20.8	
156-02319	MOC8FMOC14M	8.0	14.0	38.8	23.8	10.0	21.9	
156-02320	MOC8FMOC16M	8.0	16.0	40.6	25.7	12.0	22.9	
156-02321	MOC8FMOC19M	8.0	19.0	45.6	32.8	12.0	25.0	
156-02322	MOC8FMOC22M	8.0	22.0	48.8	36.5	12.0	26.5	
156-02324	MOC8FMOC26M	8.0	26.0	52.8	41.0	12.0	28.5	
156-02325	MOC9FMOC9M	9.0	9.0	34.3	17.2	10.0	19.4	
156-02326	MOC9FMOC10M	9.0	10.0	36.3	19.6	10.0	20.4	
156-02327	MOC9FMOC12M	9.0	12.0	38.3	22.1	10.0	21.3	
156-02328	MOC9FMOC14M	9.0	14.0	39.8	23.8	10.0	22.4	
156-02329	MOC9FMOC16M	9.0	16.0	41.7	25.7	12.0	23.4	
156-02330	MOC9FMOC19M	9.0	19.0	46.7	32.8	12.0	25.5	
156-02331	MOC9FMOC22M	9.0	22.0	49.9	36.5	12.0	27.0	
156-02333	MOC9FMOC26M	9.0	26.0	53.9	41.0	12.0	29.0	

Dimensions are approximate and subject to technical changes. Use Part No. for ordering and Type for specification purposes.

# Bundling and Securing

## Bundle Separators

### MOC Clips to MOC Clips

#### MOC to MOC

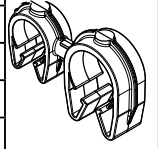
PART NO.	TYPE	Nominal Clip Diameter (ND) mm	Nominal Clip Dia. 2 (ND2) mm	Width (W) mm	Height (H) mm	Depth (D) mm	Center to Center mm	Drawing
156-02334	MOC10FMOC10M	10.0	10.0	38.1	19.6	10.0	21.1	
156-02335	MOC10FMOC12M	10.0	12.0	40.0	22.1	10.0	22.1	
156-02336	MOC10FMOC14M	10.0	14.0	41.6	23.8	10.0	23.2	
156-02337	MOC10FMOC16M	10.0	16.0	44.0	25.7	12.0	24.1	
156-02338	MOC10FMOC19M	10.0	19.0	48.4	32.8	12.0	26.2	
156-02339	MOC10FMOC22M	10.0	22.0	51.6	36.5	12.0	27.7	
156-02341	MOC10FMOC26M	10.0	26.0	55.6	41.0	12.0	29.7	
156-02342	MOC12FMOC12M	12.0	12.0	41.9	22.1	10.0	23.0	
156-02343	MOC12FMOC14M	12.0	14.0	43.4	23.8	10.0	24.1	
156-02344	MOC12FMOC16M	12.0	16.0	45.3	25.7	12.0	25.1	
156-02345	MOC12FMOC19M	12.0	19.0	50.3	32.8	12.0	27.2	
156-02346	MOC12FMOC22M	12.0	22.0	53.5	36.5	12.0	28.7	
156-02348	MOC12FMOC26M	12.0	26.0	57.5	41.0	12.0	30.7	
156-02349	MOC14FMOC14M	14.0	14.0	45.6	23.8	10.0	25.2	
156-02350	MOC14FMOC16M	14.0	16.0	47.4	25.7	12.0	26.1	
156-02351	MOC14FMOC19M	14.0	19.0	52.4	32.8	12.0	28.2	
156-02352	MOC14FMOC22M	14.0	22.0	55.6	36.5	12.0	29.7	
156-02354	MOC14FMOC26M	14.0	26.0	59.7	41.0	12.0	31.7	
156-02355	MOC16FMOC16M	16.0	16.0	49.2	25.7	12.0	26.9	
156-02356	MOC16FMOC19M	16.0	19.0	54.1	32.8	12.0	29.0	
156-02357	MOC16FMOC22M	16.0	22.0	57.3	36.5	12.0	30.5	
156-02359	MOC16FMOC26M	16.0	26.0	61.4	41.0	12.0	32.5	
156-02360	MOC19FMOC19M	19.0	19.0	59.0	32.8	12.0	31.8	
156-02361	MOC19FMOC22M	19.0	22.0	62.2	36.5	12.0	33.3	
156-02363	MOC19FMOC26M	19.0	26.0	66.3	41.0	12.0	35.3	
156-02490	MOC22FMOC22M	22.0	22.0	65.4	36.5	12.0	34.9	
156-02366	MOC22FMOC26M	22.0	26.0	69.4	41.0	12.0	36.9	
156-02369	MOC26FMOC26M	26.0	26.0	73.4	41.0	12.0	38.9	

Dimensions are approximate and subject to technical changes. Use Part No. for ordering and Type for specification purposes.

### MOC Clips to MOC Clips

#### MOC to MOC Transverse

Transverse rotatable dual routing clips keep two routings secured and separated. One clip is oriented 90 degrees from the other to provide alternative access for bundle attachment. A swivel coupler allows them to rotate independently of each other.

#### Features and Benefits

- Patented retention design features inverted retaining legs, narrow opening and circular retainer to prevent inadvertent disengagement.
- Controlled flex and angled entry promote easy installation.
- Independent rotation allows for adjustable routing orientation.



<b>MATERIAL</b>	Polyamide 6.6 high impact modified, heat and UV stabilized (PA66HIRHSUV)
<b>Operating Temperature</b>	-40°F to +230°F (-40°C to +110°C)
<b>Flammability</b>	UL 94 HB

HF ✓

RoHS ✓

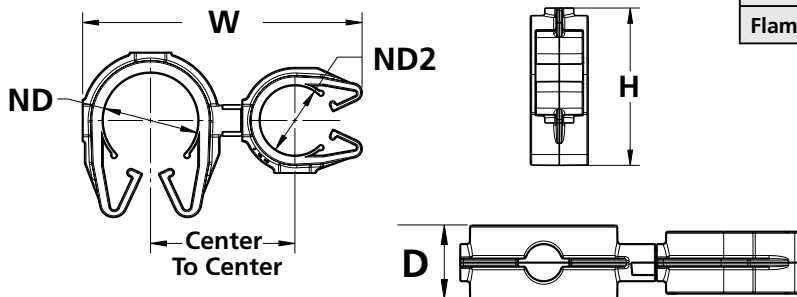

PART NO.	TYPE	Nominal Clip Diameter (ND) mm	Nominal Clip Dia. 2 (ND2) mm	Width (W) mm	Height (H) mm	Depth (D) mm	Center to Center mm	Drawing
156-01924	MOC5FMOC5M180	5.0	5.0	25.6	10.8	10.0	14.9	
156-01925	MOC5FMOC6M180	5.0	6.0	26.8	11.1	10.0	15.5	
156-01926	MOC5FMOC7M180	5.0	7.0	27.9	11.6	10.0	16.0	
156-01927	MOC5FMOC8M180	5.0	8.0	30.0	13.2	10.0	16.8	
156-01928	MOC5FMOC9M180	5.0	9.0	32.0	15.0	10.0	17.9	
156-01929	MOC5FMOC10M180	5.0	10.0	34.4	16.9	10.0	18.4	
156-01930	MOC5FMOC12M180	5.0	12.0	36.8	18.9	10.0	19.3	
156-01931	MOC5FMOC14M180	5.0	14.0	38.6	20.9	10.0	20.4	
156-01932	MOC5FMOC16M180	5.0	16.0	40.5	22.9	12.0	21.3	
156-01933	MOC5FMOC19M180	5.0	19.0	47.5	27.3	12.0	23.5	
156-01934	MOC5FMOC22M180	5.0	22.0	51.2	30.5	12.0	26.9	
156-01935	MOC5FMOC26M180	5.0	26.0	55.7	34.5	12.0	28.5	
156-01948	MOC6FMOC5M180	6.0	5.0	26.9	12.0	10.0	15.4	
156-01949	MOC6FMOC6M180	6.0	6.0	28.1	12.0	10.0	16.1	
156-01950	MOC6FMOC7M180	6.0	7.0	29.2	12.0	10.0	16.5	
156-01951	MOC6FMOC8M180	6.0	8.0	31.3	13.2	10.0	17.4	
156-01952	MOC6FMOC9M180	6.0	9.0	33.3	15.0	10.0	17.9	

Dimensions are approximate and subject to technical changes. Use Part No. for ordering and Type for specification purposes.

# Bundling and Securing

## Bundle Separators

### MOC Clips to MOC Clips

#### MOC to MOC Transverse

PART NO.	TYPE	Nominal Clip Diameter (ND) mm	Nominal Clip Dia. 2 (ND2) mm	Width (W) mm	Height (H) mm	Depth (D) mm	Center to Center mm	Drawing
156-01953	MOC6FMOC10M180	6.0	10.0	35.7	16.9	10.0	18.9	
156-01954	MOC6FMOC12M180	6.0	12.0	38.1	18.9	10.0	19.8	
156-01955	MOC6FMOC14M180	6.0	14.0	39.9	20.9	10.0	20.9	
156-01956	MOC6FMOC16M180	6.0	16.0	41.8	22.9	12.0	21.9	
156-01957	MOC6FMOC19M180	6.0	19.0	48.8	27.3	12.0	24.0	
156-01958	MOC6FMOC22M180	6.0	22.0	52.5	30.5	12.0	25.5	
156-01959	MOC6FMOC26M180	6.0	26.0	57.0	34.5	12.0	27.5	
156-01972	MOC7FMOC5M180	7.0	5.0	27.8	13.4	10.0	15.9	
156-01973	MOC7FMOC6M180	7.0	6.0	29.1	13.4	10.0	16.5	
156-01974	MOC7FMOC7M180	7.0	7.0	30.1	13.4	10.0	17.0	
156-01975	MOC7FMOC8M180	7.0	8.0	32.2	13.4	10.0	17.9	
156-01976	MOC7FMOC9M180	7.0	9.0	34.2	15.0	10.0	18.4	
156-01977	MOC7FMOC10M180	7.0	10.0	36.6	16.9	10.0	19.4	
156-01978	MOC7FMOC12M180	7.0	12.0	39.1	18.9	10.0	20.3	
156-01979	MOC7FMOC14M180	7.0	14.0	40.8	20.9	10.0	21.4	
156-01980	MOC7FMOC16M180	7.0	16.0	42.8	22.9	12.0	22.4	
156-01981	MOC7FMOC19M180	7.0	19.0	49.8	27.3	12.0	24.5	
156-01982	MOC7FMOC22M180	7.0	22.0	53.5	30.5	12.0	26.0	
156-01983	MOC7FMOC26M180	7.0	26.0	58.0	34.5	12.0	28.0	
156-01996	MOC8FMOC5M180	8.0	5.0	29.2	15.2	10.0	16.4	
156-01997	MOC8FMOC6M180	8.0	6.0	30.3	15.2	10.0	17.0	
156-01998	MOC8FMOC7M180	8.0	7.0	31.4	15.2	10.0	17.5	
156-01999	MOC8FMOC8M180	8.0	8.0	33.6	15.2	10.0	18.4	
156-02011	MOC8FMOC9M180	8.0	9.0	35.6	15.2	10.0	18.9	
156-02012	MOC8FMOC10M180	8.0	10.0	38.0	16.9	10.0	19.9	
156-02013	MOC8FMOC12M180	8.0	12.0	40.4	18.9	10.0	20.8	
156-02014	MOC8FMOC14M180	8.0	14.0	42.2	20.9	10.0	21.9	
156-02015	MOC8FMOC16M180	8.0	16.0	44.1	22.9	12.0	22.9	
156-02016	MOC8FMOC19M180	8.0	19.0	51.1	27.3	12.0	25.0	
156-02017	MOC8FMOC22M180	8.0	22.0	54.8	30.5	12.0	26.5	
156-02018	MOC8FMOC26M180	8.0	26.0	59.3	34.5	12.0	28.5	
156-02031	MOC9FMOC5M180	9.0	5.0	30.2	17.2	10.0	16.9	
156-02032	MOC9FMOC6M180	9.0	6.0	31.4	17.2	10.0	17.5	
156-02033	MOC9FMOC7M180	9.0	7.0	32.5	17.2	10.0	18.0	
156-02034	MOC9FMOC8M180	9.0	8.0	34.6	17.2	10.0	18.9	
156-02035	MOC9FMOC9M180	9.0	9.0	36.6	17.2	10.0	19.4	

Dimensions are approximate and subject to technical changes. Use Part No. for ordering and Type for specification purposes.



### MOC Clips to MOC Clips

#### MOC to MOC Transverse

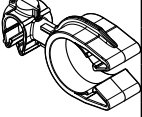
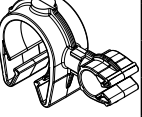
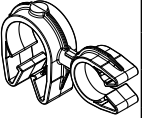
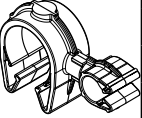
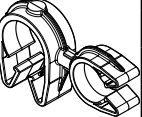
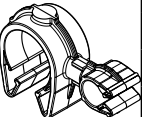
PART NO.	TYPE	Nominal Clip Diameter (ND) mm	Nominal Clip Dia. 2 (ND2) mm	Width (W) mm	Height (H) mm	Depth (D) mm	Center to Center mm	Drawing
156-02036	MOC9FMOC10M180	9.0	10.0	39.0	17.2	10.0	20.4	
156-02037	MOC9FMOC12M180	9.0	12.0	41.5	18.9	10.0	21.3	
156-02038	MOC9FMOC14M180	9.0	14.0	43.2	20.9	10.0	22.4	
156-02039	MOC9FMOC16M180	9.0	16.0	45.2	22.9	12.0	23.4	
156-02040	MOC9FMOC19M180	9.0	19.0	52.2	27.3	12.0	25.5	
156-02041	MOC9FMOC22M180	9.0	22.0	55.9	30.5	12.0	27.0	
156-02042	MOC9FMOC26M180	9.0	26.0	60.4	34.5	12.0	29.0	
156-02055	MOC10FMOC5M180	10.0	5.0	32.0	19.6	10.0	17.7	
156-02056	MOC10FMOC6M180	10.0	6.0	33.2	19.6	10.0	18.3	
156-02057	MOC10FMOC7M180	10.0	7.0	34.2	19.6	10.0	18.8	
156-02058	MOC10FMOC8M180	10.0	8.0	36.4	19.6	10.0	19.6	
156-02059	MOC10FMOC9M180	10.0	9.0	38.4	19.6	10.0	20.2	
156-02060	MOC10FMOC10M180	10.0	10.0	40.8	19.6	10.0	21.1	
156-02061	MOC10FMOC12M180	10.0	12.0	43.2	19.6	10.0	22.1	
156-02062	MOC10FMOC14M180	10.0	14.0	45.0	20.9	10.0	23.2	
156-02063	MOC10FMOC16M180	10.0	16.0	46.9	22.9	12.0	24.1	
156-02064	MOC10FMOC19M180	10.0	19.0	53.9	27.3	12.0	26.2	
156-02065	MOC10FMOC22M180	10.0	22.0	57.6	30.5	12.0	27.7	
156-02204	MOC10FMOC26M180	10.0	26.0	58.5	41.0	12.0	29.7	
156-02079	MOC12FMOC5M180	12.0	5.0	33.8	22.1	10.0	18.6	
156-02080	MOC12FMOC6M180	12.0	6.0	35.1	22.1	10.0	19.3	
156-02081	MOC12FMOC7M180	12.0	7.0	36.1	22.1	10.0	19.7	
156-02082	MOC12FMOC8M180	12.0	8.0	38.2	22.1	10.0	20.6	
156-02083	MOC12FMOC9M180	12.0	9.0	40.2	22.1	10.0	21.1	
156-02084	MOC12FMOC10M180	12.0	10.0	42.6	22.1	10.0	22.1	
156-02085	MOC12FMOC12M180	12.0	12.0	45.1	22.1	10.0	23.0	
156-02086	MOC12FMOC14M180	12.0	14.0	46.8	22.1	10.0	24.1	
156-02087	MOC12FMOC16M180	12.0	16.0	48.8	22.9	12.0	25.1	
156-02088	MOC12FMOC19M180	12.0	19.0	55.8	27.3	12.0	27.2	
156-02089	MOC12FMOC22M180	12.0	22.0	59.5	30.5	12.0	28.7	
156-02090	MOC12FMOC26M180	12.0	26.0	64.0	34.5	12.0	30.7	
156-02103	MOC14FMOC5M180	14.0	5.0	36.0	23.8	10.0	19.7	
156-02104	MOC14FMOC6M180	14.0	6.0	37.2	23.8	10.0	20.3	
156-02105	MOC14FMOC7M180	14.0	7.0	38.2	23.8	10.0	20.8	
156-02106	MOC14FMOC8M180	14.0	8.0	40.4	23.8	10.0	21.6	
156-02107	MOC14FMOC9M180	14.0	9.0	42.4	23.8	10.0	22.1	

Dimensions are approximate and subject to technical changes. Use Part No. for ordering and Type for specification purposes.

# Bundling and Securing

## Bundle Separators

### MOC Clips to MOC Clips

#### MOC to MOC Transverse

PART NO.	TYPE	Nominal Clip Diameter (ND) mm	Nominal Clip Dia. 2 (ND2) mm	Width (W) mm	Height (H) mm	Depth (D) mm	Center to Center mm	Drawing
156-02108	MOC14FMOC10M180	14.0	10.0	44.8	23.8	10.0	23.1	
156-02109	MOC14FMOC12M180	14.0	12.0	47.2	23.8	10.0	24.0	
156-02110	MOC14FMOC14M180	14.0	14.0	49.0	23.8	10.0	25.2	
156-02111	MOC14FMOC16M180	14.0	16.0	50.9	23.8	12.0	26.1	
156-02112	MOC14FMOC19M180	14.0	19.0	57.9	27.3	12.0	28.2	
156-02113	MOC14FMOC22M180	14.0	22.0	61.6	30.5	12.0	29.7	
156-02114	MOC14FMOC26M180	14.0	26.0	66.1	34.5	12.0	31.7	
156-02127	MOC16FMOC5M180	16.0	5.0	37.7	25.7	12.0	20.5	
156-02128	MOC16FMOC6M180	16.0	6.0	39.0	25.7	12.0	21.3	
156-02129	MOC16FMOC7M180	16.0	7.0	40.0	25.7	12.0	21.7	
156-02130	MOC16FMOC8M180	16.0	8.0	42.1	25.7	12.0	22.4	
156-02131	MOC16FMOC9M180	16.0	9.0	44.1	25.7	12.0	23.2	
156-02132	MOC16FMOC10M180	16.0	10.0	46.5	25.7	12.0	24.1	
156-02133	MOC16FMOC12M180	16.0	12.0	49.0	25.7	12.0	25.0	
156-02134	MOC16FMOC14M180	16.0	14.0	50.7	25.7	12.0	26.2	
156-02135	MOC16FMOC16M180	16.0	16.0	52.7	25.7	12.0	27.1	
156-02136	MOC16FMOC19M180	16.0	19.0	59.6	27.3	12.0	29.2	
156-02137	MOC16FMOC22M180	16.0	22.0	63.3	30.5	12.0	30.7	
156-02138	MOC16FMOC26M180	16.0	26.0	67.9	34.5	12.0	32.7	
156-02151	MOC19FMOC5M180	19.0	5.0	42.6	32.8	12.0	23.2	
156-02152	MOC19FMOC6M180	19.0	6.0	43.8	32.8	12.0	23.9	
156-02153	MOC19FMOC7M180	19.0	7.0	44.8	32.8	12.0	24.3	
156-02154	MOC19FMOC8M180	19.0	8.0	47.0	32.8	12.0	25.2	
156-02155	MOC19FMOC9M180	19.0	9.0	49.0	32.8	12.0	25.7	
156-02156	MOC19FMOC10M180	19.0	10.0	51.4	32.8	12.0	27.5	
156-02157	MOC19FMOC12M180	19.0	12.0	53.8	32.8	12.0	27.6	
156-02158	MOC19FMOC14M180	19.0	14.0	55.6	32.8	12.0	28.7	
156-02159	MOC19FMOC16M180	19.0	16.0	57.5	32.8	12.0	29.7	
156-02160	MOC19FMOC19M180	19.0	19.0	64.5	32.8	12.0	31.8	
156-02161	MOC19FMOC22M180	19.0	22.0	68.2	32.8	12.0	33.3	
156-02162	MOC19FMOC26M180	19.0	26.0	72.7	34.5	12.0	35.3	
156-02175	MOC22FMOC5M180	22.0	5.0	45.7	36.5	12.0	24.9	
156-02176	MOC22FMOC6M180	22.0	6.0	47.0	36.5	12.0	25.5	
156-02177	MOC22FMOC7M180	22.0	7.0	48.0	36.5	12.0	26.0	
156-02178	MOC22FMOC8M180	22.0	8.0	50.1	36.5	12.0	26.8	
156-02179	MOC22FMOC9M180	22.0	9.0	52.1	36.5	12.0	27.3	

Dimensions are approximate and subject to technical changes. Use Part No. for ordering and Type for specification purposes.

### MOC Clips to MOC Clips

#### MOC to MOC Transverse

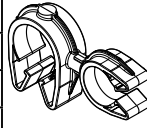
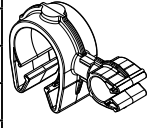
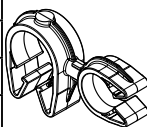
PART NO.	TYPE	Nominal Clip Diameter (ND) mm	Nominal Clip Dia. 2 (ND2) mm	Width (W) mm	Height (H) mm	Depth (D) mm	Center to Center mm	Drawing
156-02180	MOC22FMOC10M180	22.0	10.0	54.5	36.5	12.0	28.3	
156-02181	MOC22FMOC12M180	22.0	12.0	57.0	36.5	12.0	29.2	
156-02182	MOC22FMOC14M180	22.0	14.0	58.7	36.5	12.0	30.3	
156-02183	MOC22FMOC16M180	22.0	16.0	60.7	36.5	12.0	31.3	
156-02184	MOC22FMOC19M180	22.0	19.0	67.6	36.5	12.0	33.4	
156-02185	MOC22FMOC22M180	22.0	22.0	71.4	36.5	12.0	35.0	
156-02186	MOC22FMOC26M180	22.0	26.0	75.9	36.5	12.0	36.9	
156-02199	MOC26FMOC5M180	26.0	5.0	49.7	41.0	12.0	26.9	
156-02200	MOC26FMOC6M180	26.0	6.0	51.0	41.0	12.0	27.5	
156-02201	MOC26FMOC7M180	26.0	7.0	52.0	41.0	12.0	28.0	
156-02202	MOC26FMOC8M180	26.0	8.0	54.1	41.0	12.0	28.8	
156-02203	MOC26FMOC9M180	26.0	9.0	56.1	41.0	12.0	29.3	
156-02066	MOC26FMOC10M180	26.0	10.0	62.1	34.5	12.0	30.3	
156-02205	MOC26FMOC12M180	26.0	12.0	61.0	41.0	12.0	31.1	
156-02206	MOC26FMOC14M180	26.0	14.0	62.7	41.0	12.0	32.4	
156-02207	MOC26FMOC16M180	26.0	16.0	64.7	41.0	12.0	33.3	
156-02208	MOC26FMOC19M180	26.0	19.0	71.7	41.0	12.0	35.5	
156-02209	MOC26FMOC22M180	26.0	22.0	75.4	41.0	12.0	37.0	
156-02210	MOC26FMOC26M180	26.0	26.0	79.9	41.0	12.0	38.9	

Dimensions are approximate and subject to technical changes. Use Part No. for ordering and Type for specification purposes.

# Bundling and Securing

## Bundle Separators

### MOC Clips to LOC Clamps

#### MOC to LOC

Rotatable dual routing clip and clamp combination keeps two routings secured and separated. A swivel coupler allows them to rotate independently of each other.

#### Features and Benefits

- Patented retention design of clip features inverted retaining legs, narrow opening and circular retainer to prevent inadvertent disengagement.
- Clip and clamp both offer easy bundle installation.
- Independent rotation allows for adjustable routing orientation.
- Locking clamp dynamically fits a range of bundle sizes.

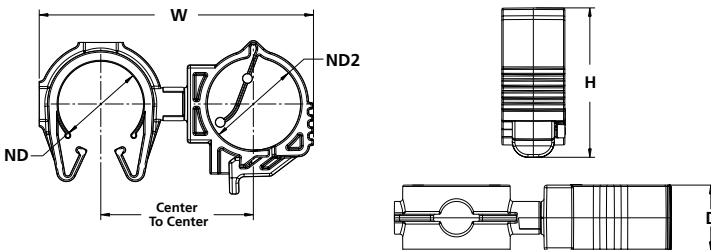

<b>MATERIAL</b>	Polyamide 6.6 high impact modified, heat and UV stabilized (PA66HIRHSUV)
<b>Operating Temperature</b>	-40°F to +230°F (-40°C to +110°C)
<b>Flammability</b>	UL 94 HB



ART NO.	TYPE	Nominal Clip Diameter (ND) mm	Nominal Clip Dia. 2 (ND2) mm	Width (W) mm	Height (H) mm	Depth (D) mm	Center to Center mm	Drawing
156-01827	MOC5LOC5-9	5.0	5.0 - 9.0	35.1	23.6	12.0	20.7	
156-01851	MOC5LOC10-14	5.0	10.0 - 14.0	39.1	27.4	12.0	22.9	
156-01875	MOC5LOC15-19	5.0	15.0 - 19.0	39.8	33.4	12.0	25.2	
156-01899	MOC5LOC20-25	5.0	20.0 - 25.0	48.9	38.9	12.0	28.2	
156-01829	MOC6LOC5-9	6.0	5.0 - 9.0	36.3	23.6	12.0	21.2	
156-01853	MOC6LOC10-14	6.0	10.0 - 14.0	40.4	27.4	12.0	23.4	
156-01877	MOC6LOC15-19	6.0	15.0 - 19.0	41.1	33.4	12.0	25.7	
156-01902	MOC6LOC20-25	6.0	20.0 - 25.0	50.2	38.9	12.0	28.8	
156-01831	MOC7LOC5-9	7.0	5.0 - 9.0	37.2	23.6	12.0	21.7	
156-01855	MOC7LOC10-14	7.0	10.0 - 14.0	41.3	27.4	12.0	23.9	
156-01879	MOC7LOC15-19	7.0	15.0 - 19.0	42.0	33.4	12.0	26.2	
156-01904	MOC7LOC20-25	7.0	20.0 - 25.0	51.1	38.9	12.0	29.3	
156-01833	MOC8LOC5-9	8.0	5.0 - 9.0	38.5	23.6	12.0	22.2	
156-01857	MOC8LOC10-14	8.0	10.0 - 14.0	42.6	27.4	12.0	24.5	
156-01881	MOC8LOC15-19	8.0	15.0 - 19.0	43.3	33.4	12.0	26.7	
156-01614	MOC8LOC20	8.0	20.0 - 25.0	52.4	38.9	12.0	29.7	
156-01835	MOC9LOC5-9	9.0	5.0 - 9.0	39.6	23.6	12.0	22.7	
156-01859	MOC9LOC10-14	9.0	10.0 - 14.0	43.7	27.4	12.0	25.0	
156-01883	MOC9LOC15-19	9.0	15.0 - 19.0	44.4	33.4	12.0	27.4	
156-01908	MOC9LOC20-25	9.0	20.0 - 25.0	53.5	38.9	12.0	30.4	

Dimensions are approximate and subject to technical changes. Use Part No. for ordering and Type for specification purposes.

### MOC Clips to LOC Clamps

#### MOC to LOC

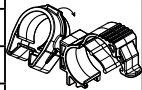
ART NO.	TYPE	Nominal Clip Diameter (ND) mm	Nominal Clip Dia. 2 (ND2) mm	Width (W) mm	Height (H) mm	Depth (D) mm	Center to Center mm	Drawing
156-01837	MOC10LOC5-9	10.0	5.0 - 9.0	41.3	23.6	12.0	23.5	
156-01861	MOC10LOC10-14	10.0	10.0 - 14.0	45.4	27.4	12.0	25.5	
156-01885	MOC10LOC15-19	10.0	15.0 - 19.0	46.1	33.4	12.0	27.9	
156-01910	MOC10LOC20-25	10.0	20.0 - 25.0	55.2	38.9	12.0	30.9	
156-01839	MOC12LOC5-9	12.0	5.0 - 9.0	43.2	23.6	12.0	24.4	
156-01863	MOC12LOC10-14	12.0	10.0 - 14.0	47.3	27.4	12.0	26.4	
156-01887	MOC12LOC15-19	12.0	15.0 - 19.0	48.0	33.4	12.0	29.0	
156-01912	MOC12LOC20-25	12.0	20.0 - 25.0	57.1	38.9	12.0	31.9	
156-01841	MOC14LOC5-9	14.0	5.0 - 9.0	45.1	23.8	12.0	25.5	
156-01865	MOC14LOC10-14	14.0	10.0 - 14.0	49.2	27.4	12.0	27.5	
156-01889	MOC14LOC15-19	14.0	15.0 - 19.0	49.9	33.4	12.0	29.9	
156-01914	MOC14LOC20-25	14.0	20.0 - 25.0	59.0	38.9	12.0	32.9	
156-01843	MOC16LOC5-9	16.0	5.0 - 9.0	47.1	25.7	12.0	26.2	
156-01867	MOC16LOC10-14	16.0	10.0 - 14.0	51.2	27.4	12.0	28.2	
156-01891	MOC16LOC15-19	16.0	15.0 - 19.0	51.9	33.4	12.0	30.8	
156-01916	MOC16LOC20-25	16.0	20.0 - 25.0	61.0	38.9	12.0	33.7	
156-01845	MOC19LOC5-9	19.0	5.0 - 9.0	50.7	32.8	12.0	29.0	
156-01869	MOC19LOC10-14	19.0	10.0 - 14.0	54.8	32.8	12.0	31.0	
156-01893	MOC19LOC15-19	19.0	15.0 - 19.0	55.5	33.4	12.0	33.5	
156-01918	MOC19LOC20-25	19.0	20.0 - 25.0	64.6	38.9	12.0	36.5	
156-01847	MOC22LOC5-9	22.0	5.0 - 9.0	52.1	36.5	12.0	30.6	
156-01871	MOC22LOC10-14	22.0	10.0 - 14.0	56.2	36.5	12.0	32.6	
156-01895	MOC22LOC15-19	22.0	15.0 - 19.0	56.9	36.5	12.0	35.0	
156-01920	MOC22LOC20-25	22.0	20.0 - 25.0	66.0	38.9	12.0	38.1	
156-01849	MOC26LOC5-9	26.0	5.0 - 9.0	59.1	41.0	12.0	32.7	
156-01873	MOC26LOC10-14	26.0	10.0 - 14.0	63.2	41.0	12.0	34.7	
156-01897	MOC26LOC15-19	26.0	15.0 - 19.0	63.9	41.0	12.0	37.0	
156-01922	MOC26LOC20-25	26.0	20.0 - 25.0	73.0	41.0	12.0	40.1	

Dimensions are approximate and subject to technical changes. Use Part No. for ordering and Type for specification purposes.

# Bundling and Securing

## Self-Affixing Cable Ties

### MOC Cable Ties

#### Clip with Swivel Tie

Rotatable routing clip coupled to a cable tie that keeps two routings secured and separated. Tie provides additional security against axial slip by clamping around solid tube, pipe or harness. The swivel coupler allows the two routings to rotate independently of each other.

#### Features and Benefits

- Patented retention design on clip features inverted retaining legs, narrow opening and circular retainer to prevent inadvertent disengagement.
- Controlled flex and angled entry promote easy installation.
- Independent rotation allows for adjustable routing orientation.
- Cable tie accommodates wide range of secondary bundle sizes.



<b>MATERIAL</b>	Polyamide 6.6 high impact modified, heat and UV stabilized (PA66HIRHSUV)
<b>Operating Temperature</b>	-40°F to +230°F (-40°C to +110°C)
<b>Flammability</b>	UL 94 HB



PART NO.	TYPE	Nominal Clip Diameter (ND) mm	Max Tie Bundle Diameter mm	Clip Length (L) mm	Height (H) mm	Depth (D) mm	Center to Tie mm	Drawing
156-01773	T50SMVCMOC5M	5.0	50.0	15.6	22.8	10.0	12.7	
156-01774	T50SMVCMOC6M	6.0	50.0	18.4	24.0	10.0	13.5	
156-01775	T50SMVCMOC7M	7.0	50.0	18.9	25.4	10.0	14.0	
156-01657	T50SMVCMOC8	8.0	50.0	20.5	17.2	10.0	14.8	
156-01722	T50SMVCMOC9M	9.0	50.0	22.3	29.2	10.0	15.4	
156-01776	T50SMVCMOC10M	10.0	50.0	24.2	31.6	10.0	16.3	
156-01777	T50SMVCMOC12M	12.0	50.0	26.2	34.1	10.0	17.3	
156-01778	T50SMVCMOC14M	14.0	50.0	28.2	35.8	10.0	18.4	
156-01656	T50SMVCMOC16	16.0	50.0	30.2	37.5	12.0	19.2	
156-01779	T50SMVCMOC19M	19.0	50.0	34.6	44.8	12.0	21.4	
156-01780	T50SMVCMOC22M	22.0	50.0	37.8	48.5	12.0	22.9	
156-01781	T50SMVCMOC26M	26.0	50.0	48.3	53.0	12.0	24.9	
156-02239	T50SVCMOC5M	5.0	35.0	15.6	22.8	10.0	12.7	
156-02240	T50SVCMOC6M	6.0	35.0	18.4	24.0	10.0	13.5	
156-02241	T50SVCMOC7M	7.0	35.0	18.9	25.4	10.0	14.0	
156-02242	T50SVCMOC8M	8.0	35.0	24.2	17.2	10.0	14.6	
156-02243	T50SVCMOC9M	9.0	35.0	22.3	29.2	10.0	15.4	
156-02244	T50SVCMOC10M	10.0	35.0	24.2	31.6	10.0	16.3	
156-02245	T50SVCMOC12M	12.0	35.0	26.2	34.1	10.0	17.3	
156-01658	T50SVCMOC14M	14.0	35.0	28.2	35.8	10.0	18.4	
156-01667	T50SVCMOC16M	16.0	35.0	30.2	37.5	12.0	19.3	
156-02246	T50SVCMOC19M	19.0	35.0	34.6	44.8	12.0	21.4	
156-02247	T50SVCMOC22M	22.0	35.0	37.8	48.5	12.0	22.9	
156-02248	T50SVCMOC26M	26.0	35.0	48.3	53.0	12.0	24.9	

Dimensions are approximate and subject to technical changes. Use Part No. for ordering and Type for specification purposes.

### MOC Cable Ties

#### Transverse Clip with Swivel Tie

Rotatable routing clips are coupled to cable ties to keep two routings secured and separated. Tie provides additional security against axial slip by clamping around solid tube, pipe or harness. The clip's orientation allows the second routing to be assembled in the direction of the first routing. The swivel coupler allows the two routings to rotate independently of each other.

#### Features and Benefits

- Patented retention design on clip features inverted retaining legs, narrow opening and circular retainer to prevent inadvertent disengagement.
- Controlled flex and angled entry promote easy installation.
- Independent rotation allows for adjustable routing orientation.
- Cable tie accommodates wide range of secondary bundle sizes.

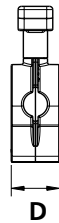

<b>MATERIAL</b>	Polyamide 6.6 high impact modified, heat and UV stabilized (PA66HIRHSUV)
<b>Operating Temperature</b>	-40°F to +230°F (-40°C to +110°C)
<b>Flammability</b>	UL 94 HB



PART NO.	TYPE	Nominal Clip Diameter (ND) mm	Max Tie Bundle Diameter mm	Clip Length (L) mm	Height (H) mm	Depth (D) mm	Center to Tie mm	Drawing
156-01782	T50SMVCMOC5M180	5.0	50.0	8.3	25.6	10.0	12.7	
156-01783	T50SMVCMOC6M180	6.0	50.0	11.1	28.4	10.0	13.5	
156-01784	T50SMVCMOC7M180	7.0	50.0	11.6	28.9	10.0	14.0	
156-01785	T50SMVCMOC8M180	8.0	50.0	13.2	30.5	10.0	14.6	
156-01786	T50SMVCMOC9M180	9.0	50.0	15.0	32.3	10.0	15.4	
156-01787	T50SMVCMOC10M180	10.0	50.0	16.9	34.2	10.0	16.3	
156-01788	T50SMVCMOC12M180	12.0	50.0	18.9	36.2	10.0	17.3	
156-01789	T50SMVCMOC14M180	14.0	50.0	20.9	38.2	10.0	18.4	
156-01751	T50SMVCMOC16M180	16.0	50.0	30.2	40.2	12.0	19.3	
156-01790	T50SMVCMOC19M180	19.0	50.0	27.3	44.6	12.0	21.4	
156-01791	T50SMVCMOC22M180	22.0	50.0	30.5	47.8	12.0	22.9	
156-01792	T50SMVCMOC26M180	26.0	50.0	34.5	51.8	12.0	24.9	
156-02249	T50SVMCMOC5M180	5.0	35.0	8.3	25.6	10.0	12.7	
156-02250	T50SVMCMOC6M180	6.0	35.0	11.1	28.4	10.0	13.5	
156-02251	T50SVMCMOC7M180	7.0	35.0	11.6	28.9	10.0	14.0	
156-02252	T50SVMCMOC8M180	8.0	35.0	13.2	30.5	10.0	14.6	
156-02253	T50SVMCMOC9M180	9.0	35.0	22.3	32.3	10.0	15.4	
156-02254	T50SVMCMOC10M180	10.0	35.0	16.9	34.2	10.0	16.3	
156-02255	T50SVMCMOC12M180	12.0	35.0	18.9	36.2	10.0	17.3	
156-02256	T50SVMCMOC14M180	14.0	35.0	20.9	38.2	10.0	18.4	
156-02257	T50SVMCMOC16M180	16.0	35.0	22.9	40.2	12.0	19.3	
156-02258	T50SVMCMOC19M180	19.0	35.0	27.3	44.6	12.0	21.4	
156-02259	T50SVMCMOC22M180	22.0	35.0	30.5	47.8	12.0	22.9	
156-02260	T50SVMCMOC26M180	26.0	35.0	34.5	51.8	12.0	24.9	

Dimensions are approximate and subject to technical changes. Use Part No. for ordering and Type for specification purposes.

# Bundling and Securing

## Self-Affixing Cable Ties

### LOC Cable Ties

#### Clamp with Swivel Tie

Rotatable routing clamps are coupled to cable ties to keep two routings secured and separated. Tie provides additional security against axial slip by clamping around solid tube, pipe or harness. The swivel coupler allows the two routings to rotate independently of each other.

#### Features and Benefits

- The 360-degree locking enclosure and cable tie dynamically fit a range of bundle sizes.
- Clamp can be opened for bundle maintenance.
- Low-profile release tab won't interfere with bundle or nearby routing.
- Independent rotation allows for adjustable routing orientation.



<b>MATERIAL</b>	Polyamide 6.6 high impact modified, heat and UV stabilized (PA66HIRHSUV)
<b>Operating Temperature</b>	-40°F to +230°F (-40°C to +110°C)
<b>Flammability</b>	UL 94 HB

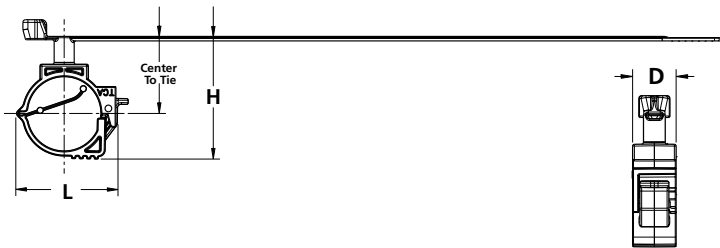

PART NO.	TYPE	Nominal Clamp Diameter (ND) mm	Max Tie Bundle Diameter mm	Clamp Length (L) mm	Height (H) mm	Depth (D) mm	Center to Tie mm	Drawing
156-02384	T50SMVCLOC5-9	5.0 - 9.0	50.0	23.7	23.6	12.0	18.6	
156-02594	T50SMVCLOC10-14	10.0 - 14.0	50.0	27.6	27.4	12.0	20.6	
156-01690	T50SMVCLOC15-19	15.0 - 19.00	50.0	31.6	33.4	12.0	23.0	
156-01714	T50SMVCLOC20-25	20.0 - 25.0	50.0	37.2	38.9	12.0	26.0	

Dimensions are approximate and subject to technical changes. Use Part No. for ordering and Type for specification purposes.



### MOC Cable Ties

#### Two-Piece Unassembled Clip Set

Two-piece design keeps two routings secured together while providing a fixed orientation for each bundle. The bi-directional saddle design allows the bundles to be coupled parallel or perpendicular to one another. Tie provides additional security against axial slip by clamping around solid tube, pipe or harness.

#### Features and Benefits

- Patented retention design on clip features inverted retaining legs, narrow opening and circular retainer to prevent inadvertent disengagement.
- Controlled flex and angled entry promote easy installation.
- Fixed connector controls routing orientation.
- Cable tie accommodates wide range of secondary bundle sizes.



<b>MATERIAL</b>	Polyamide 6.6 high impact modified, heat and UV stabilized (PA66HIRHSUV)
<b>Operating Temperature</b>	-40°F to +230°F (-40°C to +110°C)
<b>Flammability</b>	UL 94 HB

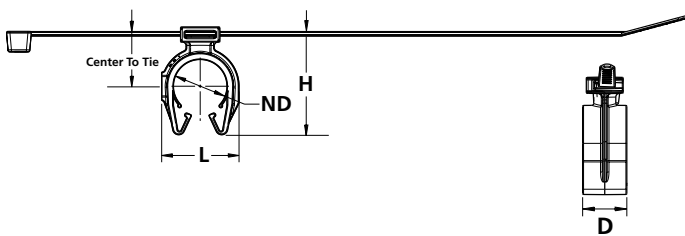

HF ✓

RoHS ✓

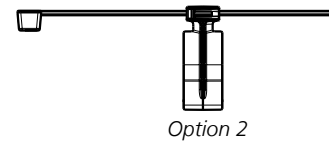
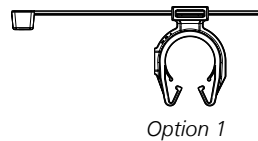

PART NO.	TYPE	Nominal Clip Diameter (ND) mm	Max Tie Bundle Diameter mm	Clip Length (L) mm	Height (H) mm	Depth (D) mm	Center to Tie mm	Drawing
156-01811	T50RMOC5SAD-SET	5.0	50.0	8.3	17.0	10.0	11.0	
156-01812	T50RMOC6SAD-SET	6.0	50.0	11.1	17.9	10.0	11.5	
156-01813	T50RMOC7SAD-SET	7.0	50.0	11.6	19.4	10.0	12.2	
156-01814	T50RMOC8SAD-SET	8.0	50.0	13.2	20.9	10.0	12.6	
156-01661	T50RMOC9SAD-SET	9.0	50.0	15.0	23.4	10.0	15.4	
156-01815	T50RMOC10SAD-SET	10.0	50.0	16.9	25.8	10.0	14.6	
156-01816	T50RMOC12SAD-SET	12.0	50.0	18.9	28.2	10.0	15.5	
156-01817	T50RMOC14SAD-SET	14.0	50.0	20.9	30.0	10.0	16.6	
156-01818	T50RMOC16SAD-SET	16.0	50.0	22.9	31.9	12.0	17.5	
156-01819	T50RMOC19SAD-SET	19.0	50.0	27.3	27.3	12.0	19.7	
156-01820	T50RMOC22SAD-SET	22.0	50.0	30.5	42.6	12.0	21.2	
156-01821	T50RMOC26SAD-SET	26.0	50.0	34.5	47.1	12.0	23.2	

Dimensions are approximate and subject to technical changes. Use Part No. for ordering and Type for specification purposes.

# Bundling and Securing

## Self-Affixing Cable Ties

### LOC Cable Ties

#### Two-Piece Unassembled Clamp Set

Two-piece design keeps two routings secured together while providing a semi-fixed orientation for each bundle. The saddle design allows 90-degree rotation of the bundles. T50R tie provides additional security against axial slip by clamping around solid tube, pipe or harness.

#### Features and Benefits

- The 360-degree locking enclosure and cable tie dynamically fit a range of bundle sizes.
- Clamp can be opened for bundle maintenance.
- Low-profile release tab won't interfere with bundle or nearby routing.
- The two bundles are allowed to rotate up to 90 degrees from one another.

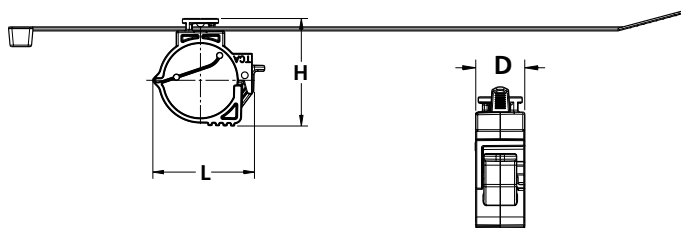

<b>MATERIAL</b>	Polyamide 6.6 high impact modified, heat and UV stabilized (PA66HIRHSUV)
<b>Operating Temperature</b>	-40°F to +230°F (-40°C to +110°C)
<b>Flammability</b>	UL 94 HB



PART NO.	TYPE	Nominal Clamp Diameter mm	Max Tie Bundle Diameter mm	Clamp Length (L) mm	Height (H) mm	Depth (D) mm	Center to Tie mm	Drawing
156-01289	T50RLOC5-9-SET	5.0 - 9.0	50.0	23.7	23.6	12.0	18.6	
156-01092	T50RLOC10-14-SET	10.0 - 14.0	50.0	27.6	27.4	12.0	20.6	
156-01292	T50RLOC15-19-SET	15.0 - 19.00	50.0	31.6	33.4	12.0	23.0	
156-01564	T50RLOC20-25SET	20.0 - 25.0	50.0	37.2	38.9	12.0	26.0	

*Dimensions are approximate and subject to technical changes. Use Part No. for ordering and Type for specification purposes.*

### MOC Clips with Fir Tree

#### Clip with Round Fir Tree

MOC with Round Fir Tree features HellermannTyton's unique retention clip with an integrated fir tree to fit securely in a 6.5 (+/-0.4) mm hole. The mount delivers a low insertion force while exhibiting high extraction resistance for a secure mounting point against a panel.

#### Features and Benefits

- Patented retention design features inverted retaining legs, narrow opening and circular retainer to prevent inadvertent disengagement.
- Controlled flex and angled entry promote easy installation.
- Fir tree demonstrates easy insertion with high extraction resistance.

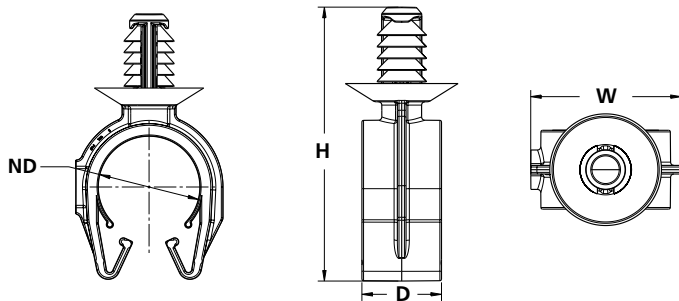

<b>MATERIAL</b>	Polyamide 6.6 high impact modified, heat and UV stabilized (PA66HIRHSUV)
<b>Operating Temperature</b>	-40°F to +230°F (-40°C to +110°C)
<b>Flammability</b>	UL 94 HB



PART NO.	TYPE	Nominal Clip Diameter (ND) mm	Panel Hole Size mm	Panel Thickness mm	Width (W) mm	Height (H) mm	Depth (D) mm	Drawings
151-02083	MOC5FT6.5	5.0	6.35 (hexagonal), 6.5 (+/- 0.4)	0.6 - 5.5	17.0	26.3	10.0	
151-01713	MOC6FT6.5	6.0	6.35 (hexagonal), 6.5 (+/- 0.4)	0.6 - 5.5	17.0	27.8	10.0	
151-01722	MOC7FT6.5	7.0	6.35 (hexagonal), 6.5 (+/- 0.4)	0.6 - 5.5	17.0	29.1	10.0	
151-01731	MOC8FT6.5	8.0	6.35 (hexagonal), 6.5 (+/- 0.4)	0.6 - 5.5	17.0	31.1	10.0	
151-01740	MOC9FT6.5	9.0	6.35 (hexagonal), 6.5 (+/- 0.4)	0.6 - 5.5	17.0	33.1	10.0	
151-01749	MOC10FT6.5	10.0	6.35 (hexagonal), 6.5 (+/- 0.4)	0.6 - 5.5	17.0	35.4	10.0	
151-01758	MOC12FT6.5	12.0	6.35 (hexagonal), 6.5 (+/- 0.4)	0.6 - 5.5	18.8	37.9	10.0	
151-01768	MOC14FT6.5	14.0	6.35 (hexagonal), 6.5 (+/- 0.4)	0.6 - 5.5	20.9	39.3	10.0	
151-01778	MOC16FT6.5	16.0	6.35 (hexagonal), 6.5 (+/- 0.4)	0.6 - 5.5	22.9	41.3	12.0	
151-01788	MOC19FT6.5	19.0	6.35 (hexagonal), 6.5 (+/- 0.4)	0.6 - 5.5	27.3	48.5	12.0	
151-01798	MOC22FT6.5	22.0	6.35 (hexagonal), 6.5 (+/- 0.4)	0.6 - 5.5	30.5	52.0	12.0	
151-01828	MOC26FT6.5	26.0	6.35 (hexagonal), 6.5 (+/- 0.4)	0.6 - 5.5	34.5	56.7	12.0	

Dimensions are approximate and subject to technical changes. Use Part No. for ordering and Type for specification purposes.

# Bundling and Securing

## Self-Affixing Clips

### LOC Clamps with Fir Tree

#### Clamp with Round Fir Tree

LOC with Round Fir Tree features HellermannTyton's unique retention clamp attached to a 6.5 mm fir tree. The mount delivers a low insertion force while exhibiting high extraction resistance for a secure mounting point against a panel.

#### Features and Benefits

- The 360-degree locking enclosure dynamically fits a range of bundle sizes.
- Clamp can be opened for bundle maintenance.
- Low-profile release tab won't interfere with bundle or nearby routing.
- Fir tree demonstrates easy insertion with high extraction resistance.

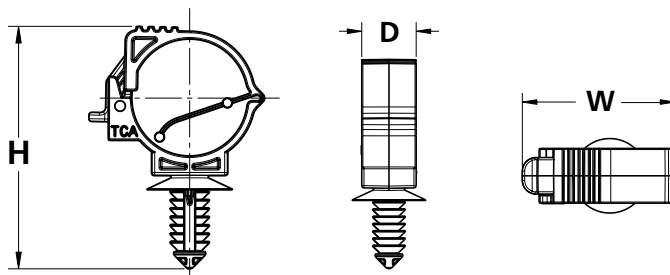

<b>MATERIAL</b>	Polyamide 6.6 high impact modified, heat and UV stabilized (PA66HIRHSUV)
<b>Operating Temperature</b>	-40°F to +230°F (-40°C to +110°C)
<b>Flammability</b>	UL 94 HB



PART NO.	TYPE	Nominal Clamp Diameter mm	Panel Hole Size mm	Panel Thickness mm	Width (W) mm	Height (H) mm	Depth (D) mm	Drawing
151-01017	LOC59FT6LG	5.0 - 9.0	6.35 (hexagonal), 6.5 (+/- 0.4)	0.6 - 8.3	23.7	37.1	12.0	
151-01166	LOC1014FT6LG	10.0 - 14.0	6.35 (hexagonal), 6.5 (+/- 0.4)	0.6 - 8.3	27.6	41.7	12.0	
151-01022	LOC15-19FT6LG	15.0 - 19.00	6.35 (hexagonal), 6.5 (+/- 0.4)	0.6 - 8.3	31.6	47.5	12.0	
151-01371	LOC20-25FT6.5LG	20.0 - 25.0	6.35 (hexagonal), 6.5 (+/- 0.4)	0.6 - 8.3	37.2	53.6	12.0	

Dimensions are approximate and subject to technical changes. Use Part No. for ordering and Type for specification purposes.

### MOC Clips with Fir Tree

#### Clip with Oval Fir Tree

MOC with Oval Fir Tree features HellermannTyton's unique retention clip attached to a 4x oval fir tree that will not rotate in the mounting hole. The mount delivers a low insertion force while exhibiting high extraction resistance for a secure mounting point against a panel. This one design exceeds automotive requirements for the four most common oval sizes: 6.2x12.2 mm, 6.5x12.5 mm, 6.5x13 mm and 7x12 mm.

#### Features and Benefits

- Patented retention design features inverted retaining legs, narrow opening and circular retainer to prevent inadvertent disengagement.
- Controlled flex and angled entry promote easy installation.
- Non-rotating fir tree demonstrates easy insertion with high extraction resistance.



<b>MATERIAL</b>	Polyamide 6.6 high impact modified, heat and UV stabilized (PA66HIRHSUV)
<b>Operating Temperature</b>	-40°F to +230°F (-40°C to +110°C)
<b>Flammability</b>	UL 94 HB

HF ✓

RoHS ✓

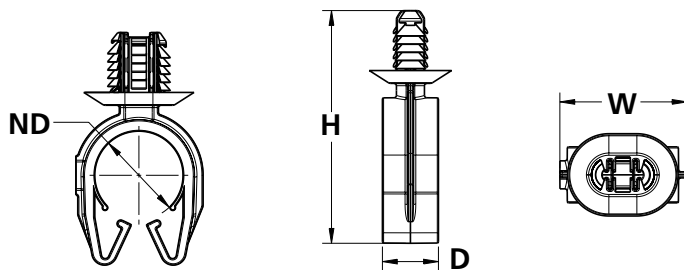

PART NO.	TYPE	Nominal Clip Diameter (ND) mm	Panel Hole Size mm	Panel Thickness mm	Width (W) mm	Height (H) mm	Depth (D) mm	Drawing
151-01759	MOC12FTOVAL	12.0	6.2 x 12.2, 6.5 x 12.5, 6.5 x 13.0, 7.0 x 12.0	0.6 - 6.8	23.6	39.5	10.0	
151-01769	MOC14FTOVAL	14.0	6.2 x 12.2, 6.5 x 12.5, 6.5 x 13.0, 7.0 x 12.0	0.6 - 6.8	23.6	40.9	10.0	
151-01779	MOC16FTOVAL	16.0	6.2 x 12.2, 6.5 x 12.5, 6.5 x 13.0, 7.0 x 12.0	0.6 - 6.8	23.6	42.6	12.0	
151-01789	MOC19FTOVAL	19.0	6.2 x 12.2, 6.5 x 12.5, 6.5 x 13.0, 7.0 x 12.0	0.6 - 6.8	27.2	49.9	12.0	
151-01799	MOC22FTOVAL	22.0	6.2 x 12.2, 6.5 x 12.5, 6.5 x 13.0, 7.0 x 12.0	0.6 - 6.8	30.5	53.3	12.0	
151-01829	MOC26FTOVAL	26.0	6.2 x 12.2, 6.5 x 12.5, 6.5 x 13.0, 7.0 x 12.0	0.6 - 6.8	34.5	58.1	12.0	

Dimensions are approximate and subject to technical changes. Use Part No. for ordering and Type for specification purposes.

# Bundling and Securing

## Self-Affixing Clips

### LOC Clamps with Fir Tree

#### Clamp with Oval Fir Tree

LOC with Oval Fir Tree features HellermannTyton's unique retention clamp attached to a 4x oval fir tree that will not rotate in the mounting hole. The mount delivers a low insertion force while exhibiting high extraction resistance for a secure mounting point against a panel. This one design exceeds automotive requirements for the four most common oval sizes: 6.2x12.2 mm, 6.5x12.5 mm, 6.5x13 mm and 7x12 mm.

#### Features and Benefits

- The 360-degree locking enclosure dynamically fits a range of bundle sizes.
- Clamp can be opened for bundle maintenance.
- Low-profile release tab won't interfere with bundle or nearby routing.
- Non-rotating fir tree demonstrates easy insertion with high extraction resistance.



<b>MATERIAL</b>	Polyamide 6.6 high impact modified, heat and UV stabilized (PA66HIRHSUV)
<b>Operating Temperature</b>	-40°F to +230°F (-40°C to +110°C)
<b>Flammability</b>	UL 94 HB

HF ✓ RoHS ✓

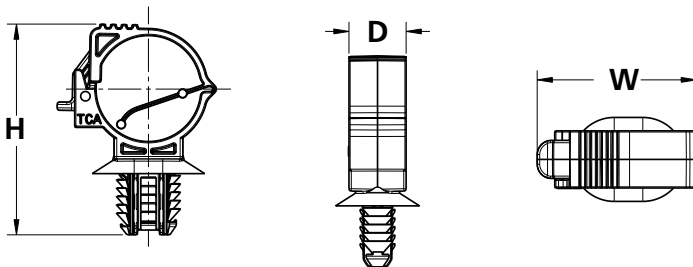

PART NO.	TYPE	Nominal Clamp Diameter mm	Panel Hole Size mm	Panel Thickness mm	Width (W) mm	Height (H) mm	Depth (D) mm	Drawing
151-01306	LOC5-9FTOVAL	5.0 - 9.0	6.2 x 12.2, 6.5 x 12.5, 6.5 x 13.0, 7.0 x 12.0	0.6 - 6.8	25.5	34.2	12.0	
151-02552	LOC10-14FTOVAL	10.0 - 14.0	6.2 x 12.2, 6.5 x 12.5, 6.5 x 13.0, 7.0 x 12.0	0.6 - 6.8	27.6	43.5	12.0	
151-01049	LOC15-19FTOVAL	15.0 - 19.00	6.2 x 12.2, 6.5 x 12.5, 6.5 x 13.0, 7.0 x 12.0	0.6 - 6.8	31.6	49.5	12.0	
151-02536	LOC20-25FTOVAL	20.0 - 25.0	6.2 x 12.2, 6.5 x 12.5, 6.5 x 13.0, 7.0 x 12.0	0.6 - 5.5	37.2	55.5	12.0	

Dimensions are approximate and subject to technical changes. Use Part No. for ordering and Type for specification purposes.

We designed over 300 configurations. Still not enough?  
***Go configure!***

Our modular design lets you create the perfect solution for your application.



Have three routings and need to mount them?



Build a configuration with an oval fir tree.

Need a way to accommodate four routings?



Add a swivel tie.

With the MOC, you get endless possibilities.  
Versatile. Secure. ***That's MOC.***



## **HellermannTyton North American Corporate Headquarters**

7930 N. Faulkner Rd, PO Box 245017  
Milwaukee, WI 53224-9517  
Phone: (414) 355-1130, (800) 537-1512  
Fax: (414) 355-7341, (800) 848-9866  
email: corp@htamericas.com  
www.hellermann.tyton.com

***IATF 16949, AS9100, ISO 9001 and ISO14001 certified***

## **HellermannTyton Canada**

Unit #4, 205 Industrial Parkway North  
Aurora, Ontario L4G 4C4 Canada  
Phone: (800) 661-2461  
Fax: (800) 390-3904  
email: sales@hellermanntyton.ca

## **HellermannTyton Mexico**

Anillo Periferico Sur 7980 Edificio 6A  
Parque Industrial Tecnologico II  
Santa Maria Tequepexpan  
Tlaquepaque, Jalisco, Mexico 45601  
Phone: 011-52-33-3-133-9880  
Fax: 011-52-33-3-133-9861  
email: info@htamericas.com.mx

***ISO 9001 certified***