

DS8934

V.34 Serial Port 5 X 3 Driver/Receiver

General Description

The DS8934 is a 5 driver X 3 receiver device optimized to provide a single chip solution for an asynchronous V.34 (V.FAST) modem serial port. The TIA/EIA-423-B (V.10) single-ended drivers are compatible with EIA/TIA-232-E (V.28) receivers, and the receivers are compatible with TIA/EIA-423-B (V.10) and EIA/TIA-232-E (V.28) drivers.

The drivers provide a minimum output voltage of $\pm 3.6V$, while the receivers offer a $+ 1.4V$ threshold, a failsafe output state, and an input range of $\pm 10V$ minimum.

Both the drivers and the receivers provide an inverting logic function and the drivers are electrically similar to the industry standard 26LS30 (3691) devices. The pinout of the device maps the common DB-9 connector, and provides a straight through connection. The device is available in a surface mount 24-pin package.

Features

- Single chip solution for V.34 async. modem serial port
- Companion 2 X 1 DS8933 for dual chip sync. serial port
- Conforms to industry standards:
 - TIA/EIA-423-B.1994 (RS-423)
 - ITU-T V.10 (formerly CCITT)
- Compatible with EIA/TIA-232-E (RS-232) and ITU-T V.28 (formerly CCITT) drivers and receivers
- Adjustable driver slew rate reduces noise generation
- Operates above 1 Mbps
- Wide receiver input voltage range $\pm 10V$
- $+ 1.4V$ receiver threshold with hysteresis
- Failsafe receivers: output high for open input
- Available in SOIC packaging

Connection Diagram

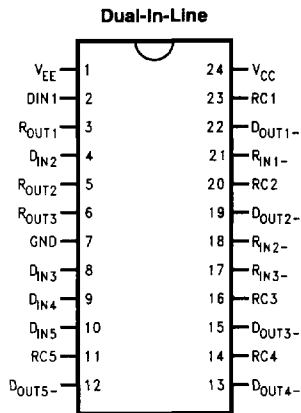

TL/F/12373-1

Order Number DS8934WM
See NS Package Number M24B

Functional Diagram

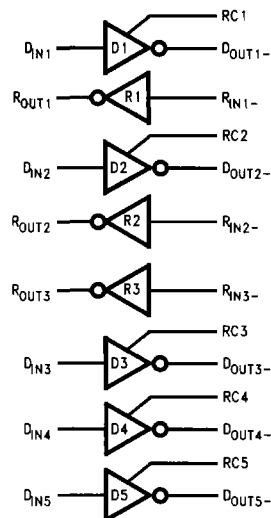

TL/F/12373-2

Absolute Maximum Ratings (Note 1)

If Military/Aerospace specified devices are required, please contact the National Semiconductor Sales Office/Distributors for availability and specifications.

Supply Voltage (V_{CC})	+7V
Supply Voltage (V_{EE})	-7V
Driver Input Voltage (D_{IN})	+7V
Driver Output Voltage (Power Off: D_{OUT})	$\pm 15V$
Receiver Input Voltage (Input to GND: R_{IN})	$\pm 25V$
Receiver Output Voltage (R_{OUT})	+5.5V
Maximum Package Power Dissipation @ +25°C WM Package	1.3W
Derate WM Package 10.7 mW/°C above +25°C	

Maximum Junction Temperature	+150°C
Storage Temperature Range	-65°C to +150°C
Lead Temp. Range Soldering (4 sec.)	+260°C
ESD Rating (HBM, 1.5 k Ω , 100 pF)	>2 kV

Recommended Operating Conditions

	Min	Typ	Max	Units
Supply Voltage (V_{CC})	+4.75	+5.0	+5.25	V
Supply Voltage (V_{EE})	-4.75	-5.0	-5.25	V
Operating Free Air Temperature (T_A)	0	25	70	°C

Electrical Characteristics

Over Supply Voltage and Operating Temperature ranges, unless otherwise specified (Notes 2 and 3)

Symbol	Parameter	Conditions	Pin	Min	Typ	Max	Units	
DRIVER CHARACTERISTICS								
V_O	Output Voltage	$R_L = \infty$ or $R_L = 3.9\text{ k}\Omega$, Figure 1	D _{OUT-}		4.4	6	V	
V_T	Output Voltage	$R_L = 3\text{ k}\Omega$, Figure 1		3.7	4.3		V	
		$R_L = 450\Omega$, Figure 1		3.6	4.1		V	
ΔV_T	Output Unbalance			0.1	0.4		V	
I_{OSD}	Short Circuit Current	$V_O = 0V$, Sourcing Current	D _{OUT-}		-100	-150	mA	
		$V_O = 0V$, Sinking Current			80	150	mA	
I_{OXD}	Power-off Leakage Current ($V_{CC} = V_{EE} = 0V$)	$V_O = +10V$		1	150		μA	
		$V_O = +6V$		1	100		μA	
		$V_O = -6V$		-1	-100		μA	
		$V_O = -10V$		-1	-150		μA	
V_{CM}	Common Mode Range	Power Off		± 10			V	
V_{IH}	High Level Input Voltage		D _{IN}	2.0			V	
V_{IL}	Low Level Input Voltage					0.8	V	
I_{IH}	High Level Input Current	$V_{IN} = 2.4V$			1	40		μA
I_{IH}	Low Level Input Current	$V_{IN} = 0.4V$			-3	-200		μA
V_{CL}	Input Clamp Voltage	$I_{IN} = -12\text{ mA}$			-0.7	-1.5		V
RECEIVER CHARACTERISTICS								
V_{T-}	Negative-Going Threshold Voltage	(See Figure 7)	R _{IN-}	0.9	1.36		V	
V_{T+}	Positive-Going Threshold Voltage				1.4	1.7		V
V_{HY}	Hysteresis				40			mV
R_{IN}	Input Resistance	$-10V \leq V_{IN} \leq +10V$		4.0	6.0	8.0	k Ω	
I_{IN}	Input Current (Power on, or Power off - $V_{CC} = V_{EE} = 0V$)	$V_{IN} = +10V$			1.6	3.25	mA	
		$V_{IN} = +3V$		0	0.38	1.50	mA	
		$V_{IN} = -3V$		0	-0.67	-1.50	mA	
		$V_{IN} = -10V$			-1.9	-3.25	mA	
V_{OH}	High Level Output Voltage	$I_{OH} = -400\text{ }\mu A$, $V_{IN} = -3V$	R _{OUT}	3.5	4.2		V	
		$I_{OH} = -400\text{ }\mu A$, $V_{IN} = \text{OPEN}$		3.5	4.2		V	
V_{OL}	Low Level Output Voltage	$I_{OL} = 8.0\text{ mA}$, $V_{IN} = +3V$			0.3	0.5	V	
I_{OSR}	Short Circuit Current	$V_O = 0V$		-15	-35	-85	mA	

Electrical Characteristics

Over Supply Voltage and Operating Temperature ranges, unless otherwise specified (Notes 2 and 3) (Continued)

Symbol	Parameter	Conditions	PIn	Min	Typ	Max	Units
DEVICE CHARACTERISTICS							
I_{CC}	Power Supply Current	No Load	V_{CC}		46	65	mA
I_{EE}	Power Supply Current		V_{EE}		-10	-20	mA

Switching Characteristics

Over Supply Voltage and Operating Temperature ranges, unless otherwise specified. (Notes 4 and 5)

Symbol	Parameter	Conditions	Min	Typ	Max	Units
DRIVER CHARACTERISTICS						
t_{PHL}	Propagation Delay High to Low	$R_L = 450\Omega$, $C_L = 50\text{ pF}$, $C_C = \text{Open}$ (Figures 2 and 3)	40	175	300	ns
t_{PLH}	Propagation Delay Low to High		40	125	300	ns
t_{SK}	Skew, $ t_{PHL} - t_{PLH} $		0	50	150	ns
t_{CC}	Transition Time Coefficient	$(t_{CC}(C_C) = t_t$, where $t_t = t_r$ or t_f)		54		ns/pF
t_r	Rise Time	$R_L = 450\Omega$, $C_L = 50\text{ pF}$, $C_C = \text{Open}$ (Figures 2 and 3)		100	250	ns
t_f	Fall Time			50	250	ns
t_r	Rise Time	$R_L = 3\text{ k}\Omega$, $C_L = 2,500\text{ pF}$, $C_C = 5\text{ pF}$ (Figures 2 and 3)		275	475	ns
t_f	Fall Time			275	475	ns
SR	Slew Rate ($\pm 3V$)	Maximum Load (V.28/232)	12.6	21		V/ μs
t_r	Rise Time	$R_L = 3\text{ k}\Omega$, $C_L = 2,500\text{ pF}$, $C_C = 15\text{ pF}$ (Figures 2 and 3)		800		ns
t_f	Fall Time			800		ns
SR	Slew Rate ($\pm 3V$)	Maximum Load (V.28/232)		7		V/ μs
t_r	Rise Time	$R_L = 7\text{ k}\Omega$, $C_L = 50\text{ pF}$, $C_C = 15\text{ pF}$ (Figures 2 and 3)		800		ns
t_f	Fall Time			800		ns
SR	Slew Rate ($\pm 3V$)		Minimum Load (V.28/232)		7	

RECEIVER CHARACTERISTICS

t_{PHL}	Propagation Delay High to Low	$C_L = 15\text{ pF}$ (Figures 4 and 5)	10	29	75	ns
t_{PLH}	Propagation Delay Low to High		10	26	75	ns
t_{SK}	Skew, $ t_{PHL} - t_{PLH} $		0	3	20	ns

Note 1: "Absolute Maximum Ratings" are those values beyond which the safety of the device cannot be guaranteed. They are not meant to imply that the device should be operated at these limits. The table of "Electrical Characteristics" specifies conditions of device operation.

Note 2: Current into device pins is defined as positive. Current out of device pins is defined as negative. All voltages are referenced to ground.

Note 3: All typicals are given for: $V_{CC} = +5.0V$, $V_{EE} = -5.0V$, $T_A = +25^\circ\text{C}$ unless otherwise specified. Typical AC numbers are rounded off. Measurements of the driver with a response control capacitor connected may vary due to tolerance of the capacitor, the use of surface mount components is recommended.

Note 4: Generator waveform for all tests unless otherwise specified: $f = 500\text{ kHz}$, $Z_0 = 50\Omega$, $t_r \leq 10\text{ ns}$, $t_f \leq 10\text{ ns}$.

Note 5: C_L includes probe and jig capacitance.

Note 6: All diodes are 1N916 or equivalent.

Note 7: ESD rating HBM (1.5 k Ω , 100 pF) $\geq 2\text{ kV}$.

Parameter Measurement Information

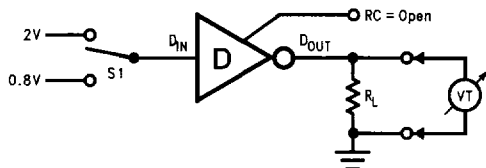

TL/F/12373-3

FIGURE 1. Driver DC Test Circuit

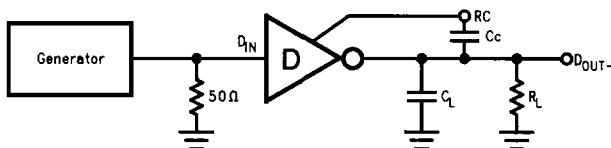

TL/F/12373-4

FIGURE 2. Driver Propagation Delay and Transition Time Test Circuit

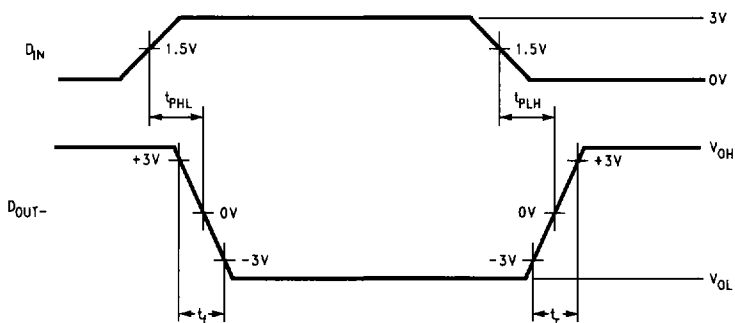

TL/F/12373-5

FIGURE 3. Driver Propagation Delay and Transition Time Waveform

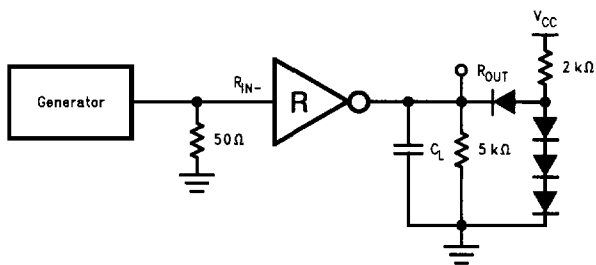

TL/F/12373-6

FIGURE 4. Receiver Propagation Delay Test Circuit (Note 6)

Parameter Measurement Information (Continued)

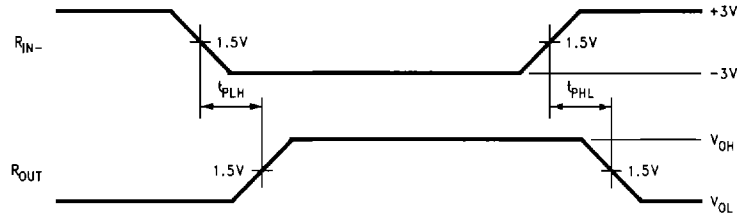

TL/F/12373-7

FIGURE 5. Receiver Propagation Delay Waveform

Pin Descriptions

Pin#	Name	Description
2, 4, 8, 9, 10	D _{IN}	TTL Driver Input Pins
12, 13, 15, 19, 22	D _{OUT-}	Inverting Driver Output Pin
11, 14, 16, 20, 23	RC	Driver Response Control Pin
17, 18, 21	R _{IN-}	Inverting Receiver Input Pin
3, 5, 6	R _{OUT}	Receiver Output Pin
7	GND	Ground Pin
1	V _{EE}	Negative Power Supply Pin, -5V ± 5%
24	V _{CC}	Positive Power Supply Pin, +5V ± 5%

Truth Tables

Driver (D1-5)

Input D _{IN}	Output D _{OUT-}
L	H
H	L

H = Logic high level (steady state)
L = Logic low level (steady state)

Receiver (R1-3)

Input R _{IN-}	Output R _{OUT}
≤ +0.9V	H
≥ +1.7V	L
OPEN†	H

†OPEN = non-terminated

Typical Application Information

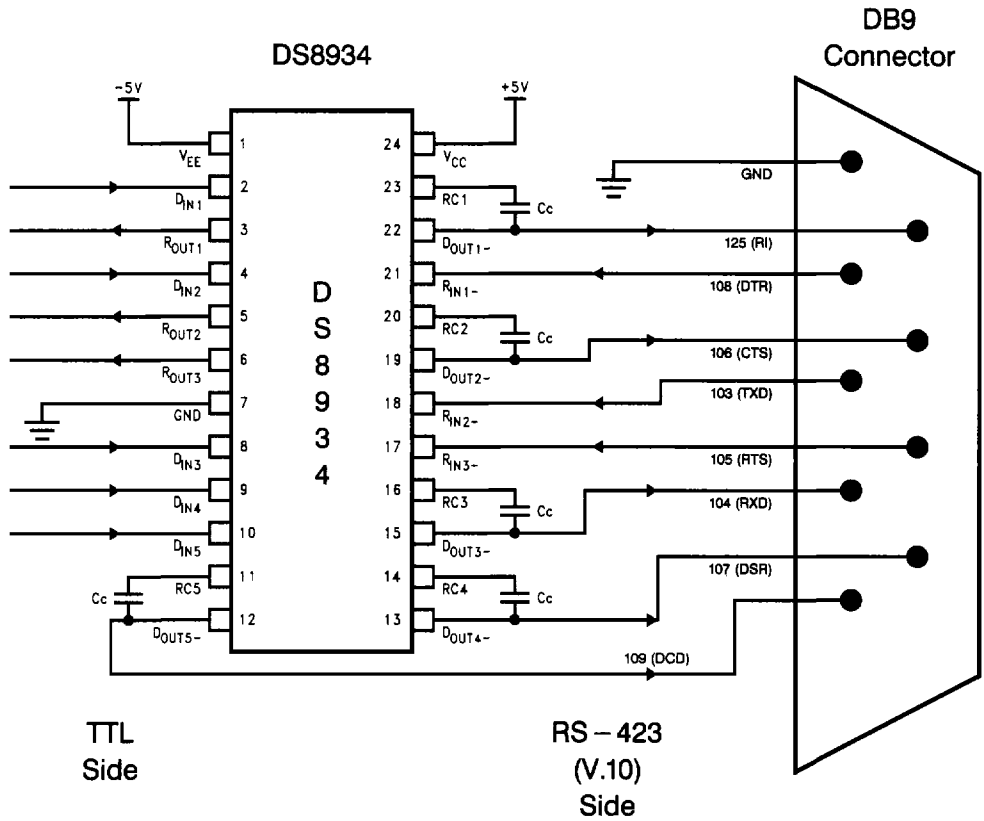

FIGURE 6. Typical V.34 9-Pin DCE Application

TL/F/12373-8

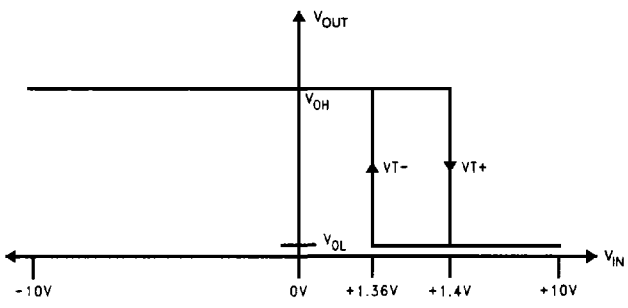
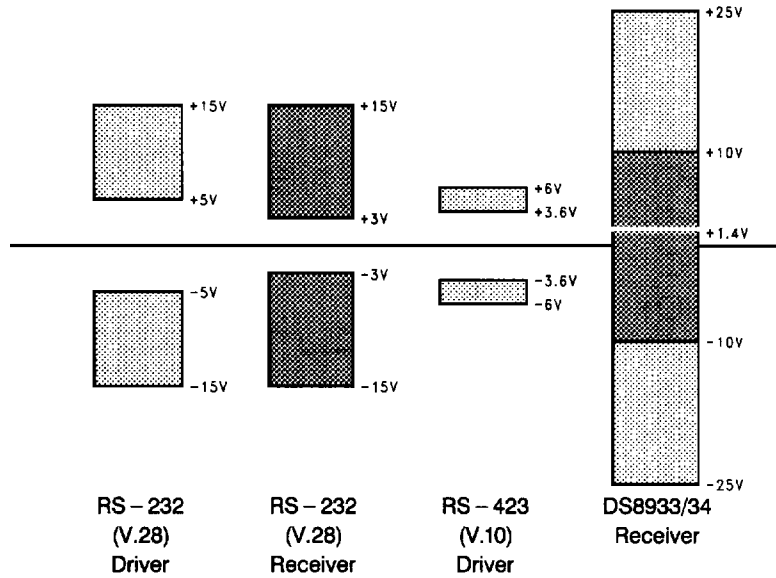

FIGURE 7. Receiver Threshold Voltage Transfer Curve (VTC)

TL/F/12373-9

Typical Application Information (Continued)



TL/F/12373-10

FIGURE 8. RS-423 and RS-232 Levels

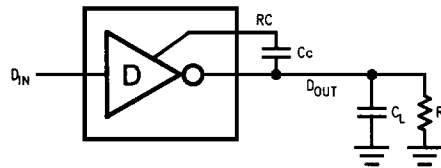

TL/F/12373-11

FIGURE 9. External Slew Rate Control Capacitor Connection