

Product Document



Eval Kit Manual

AS5172B

Adapter Board

AS5172B-TS_EK_AB

Content Guide

1	Introduction	3
1.1	Kit Content	3
2	Board description	4
2.1	Mounting the AS5172B adapter board.....	5
3	AS5172B adapter board and pinout.....	6
4	Operation case	7
4.1	Connection to AS5172 PSI5 Programming Board	7
5	AS5172B-TS_EK_AB Hardware	8
5.1	AS5172B-TS_EK_AB schematics	8
5.2	AS5172B-TS_EK_AB PCB layout	9
6	Ordering & Contact Information	10
7	Copyrights & Disclaimer.....	11
8	Revision Information	12

1 Introduction

The AS5172B adapter board is a small PCB allowing simple and quick testing or evaluation of the AS5172B magnetic position sensor without the need to design and manufacture an own PCB.

1.1 Kit Content

Figure 1: Kit content

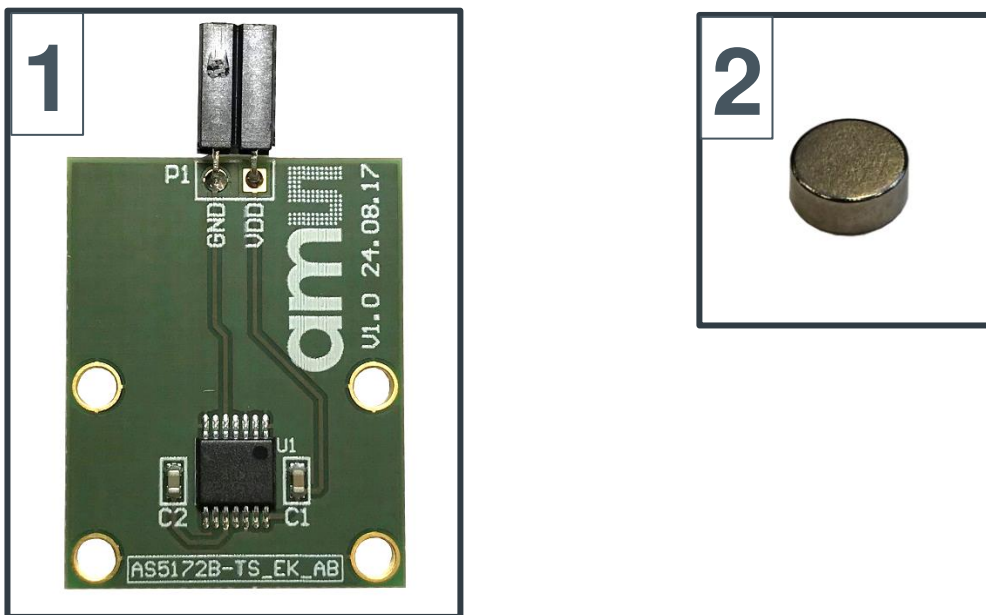

Pos.	Item	Comment
1	AS5172B-TS_EK_AB	Adapter board
2	AS5000-MD8H-1	Diametric Magnet, D8x2.5mm, NdFeB, Bomatec AG

2 Board description

The PCB can be connected to an external programmer or to the AS5172 PSI5 Programming Board, which can be used in combination with the AS5172 Software GUI provided by ams.

P1 is populated with a 1x2 female pin header it is required for the power supply (VDD and GND) and programming interface. (UART-over-PSI5).

All necessary external components C1 (VDD-GND) and C2 (VDD3V3-GND) are already populated to the PCB.

Figure 2: AS5172B adapter board

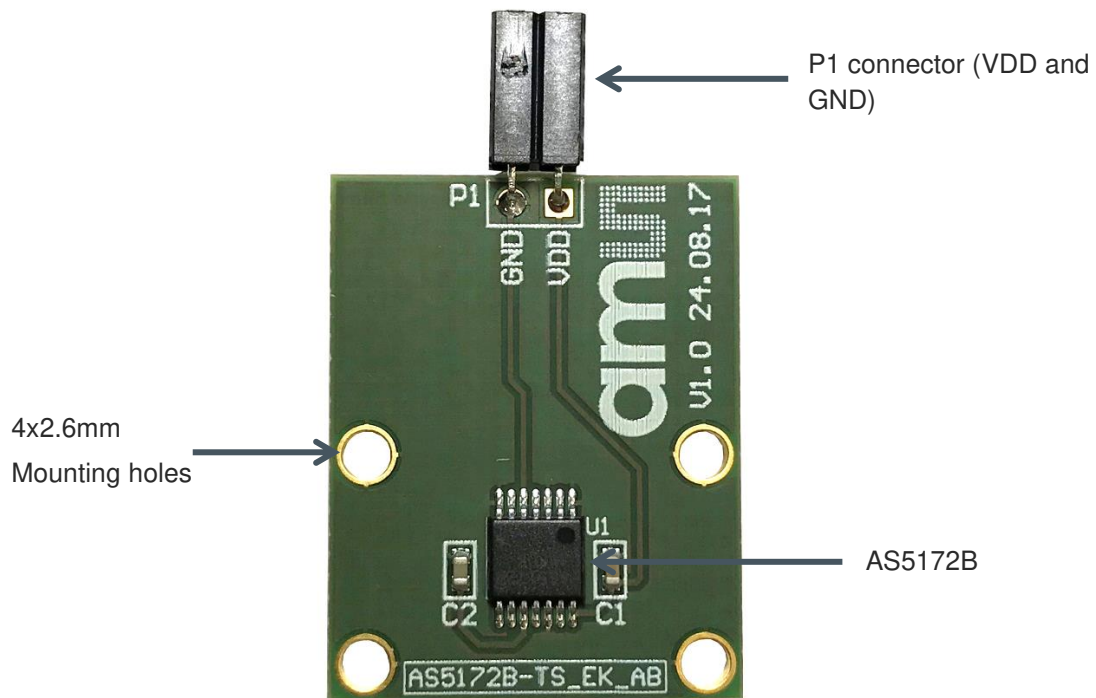

2.1 Mounting the AS5172B adapter board

Figure 3: Mounting and dimensions

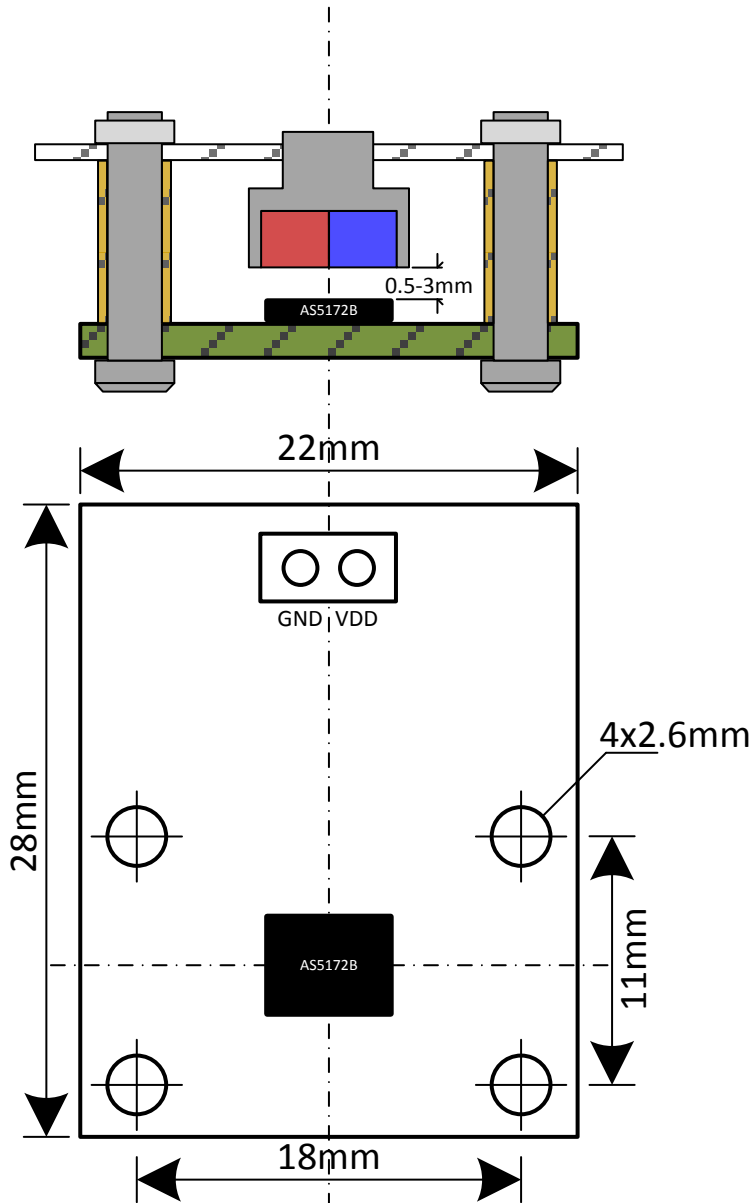

A 8x2.5mm diametric magnet must be placed over or under the AS5172B sensor, and should be centered in the middle of the package with a tolerance of 0.5mm. The airgap between the magnet surface and the package should be maintained in the range 0.5mm to 3mm. The magnet holder must not be ferromagnetic. Materials as brass, copper, aluminum, stainless steel are the best choices to make this part.

3 AS5172B adapter board and pinout

Figure 4: AS5172B adapter board and sensor pinout

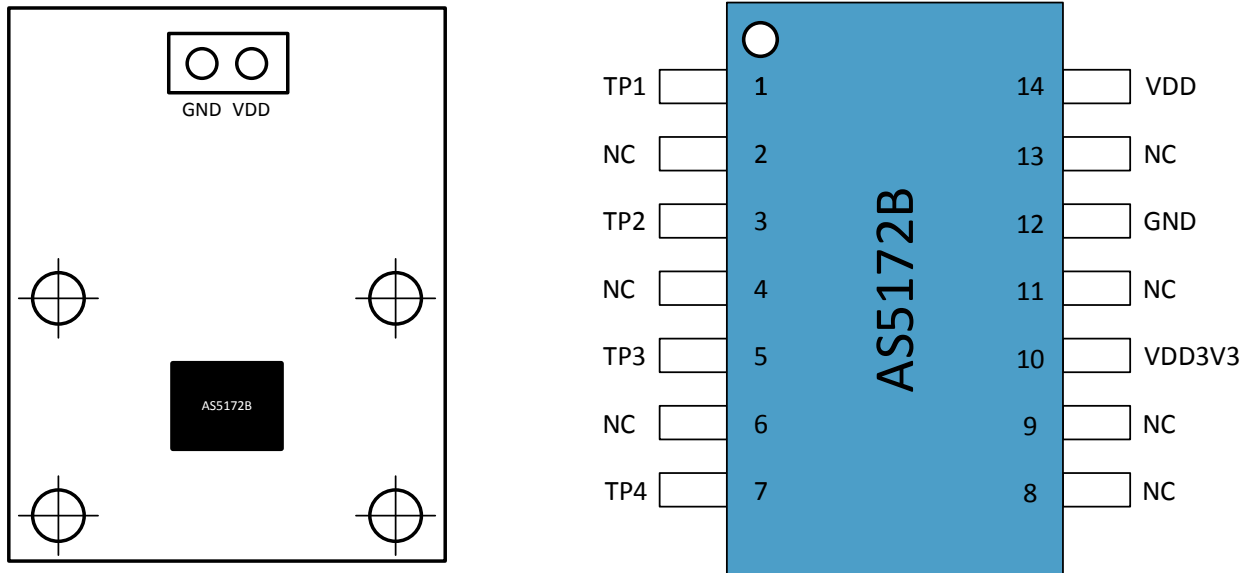

Pin# Board	Pin# AS5172B	Symbol board	Type	Description
P1 - 1	14	VDD	Power supply	Positive supply voltage (UART-over-PSI5)
P1 - 2	12	GND	Power supply	Ground

4 Operation case

4.1 Connection to AS5172 PSI5 Programming Board

The AS5172B adapter board can be directly connected to the AS5172 PSI5 Programming Board using only two lines (VDD, GND). The voltage supply is coming directly from the programmer which need to be supplied with 12V externally. The UART-over-PSI5 communication is taking place over the VDD line.

Figure 5: UART-over-PSI5 communication with AS5172 PSI5 Programming Board

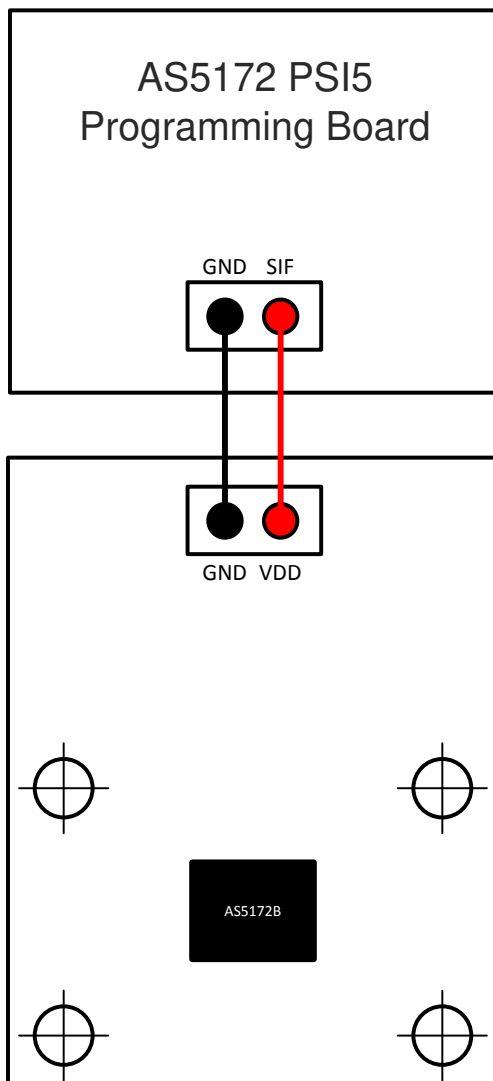

5 AS5172B-TS_EK_AB Hardware

5.1 AS5172B-TS_EK_AB schematics

The PCB schematic is shown in Figure 6: Schematics.

Figure 6: Schematics

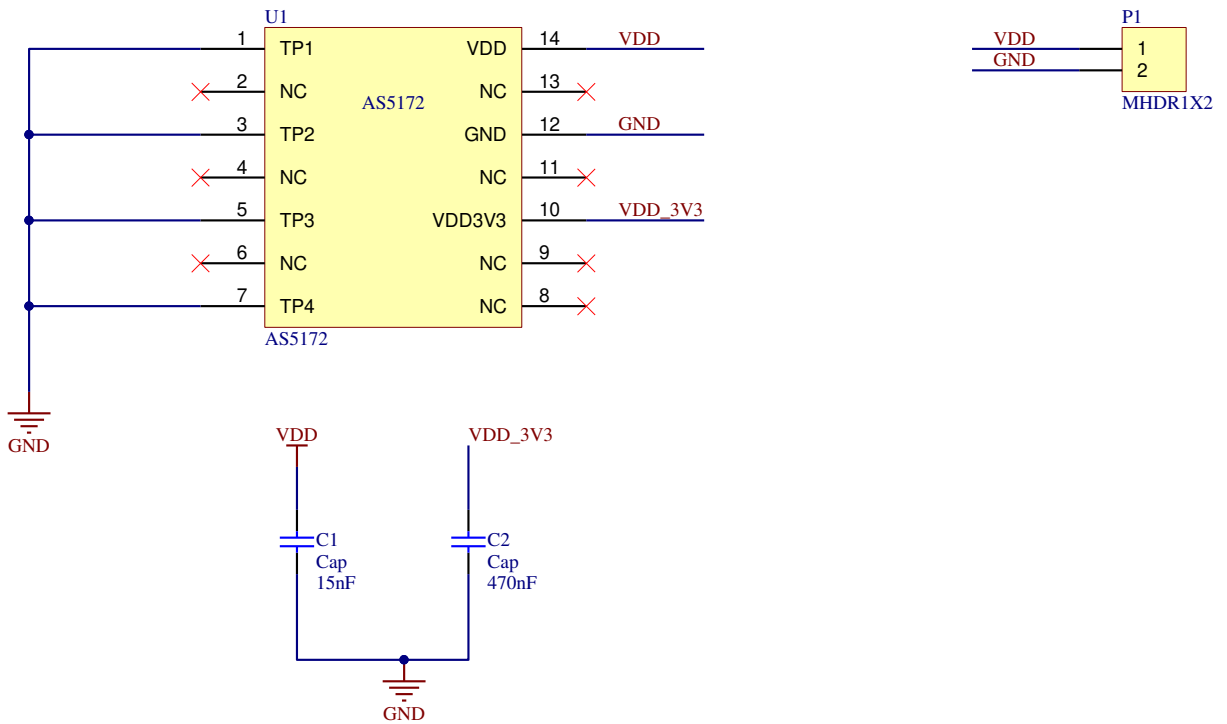

5.2 AS5172B-TS_EK_AB PCB layout

The PCB layout is shown in Figure 7: Top Layer and Figure 8: Bottom Layer.

Figure 7: Top Layer

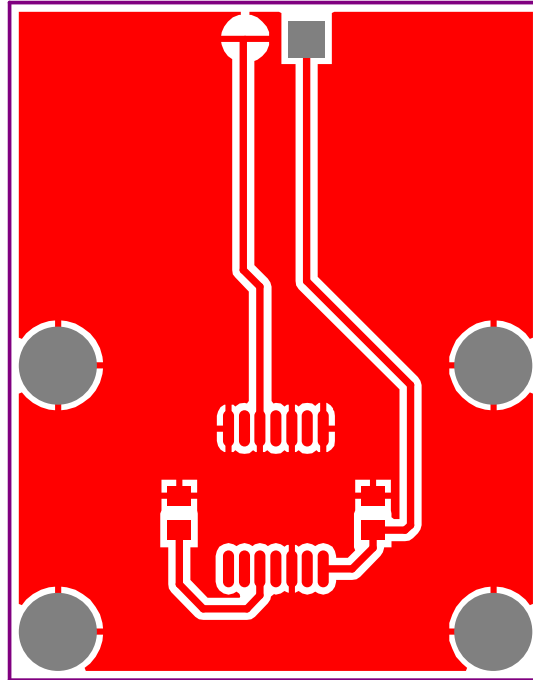
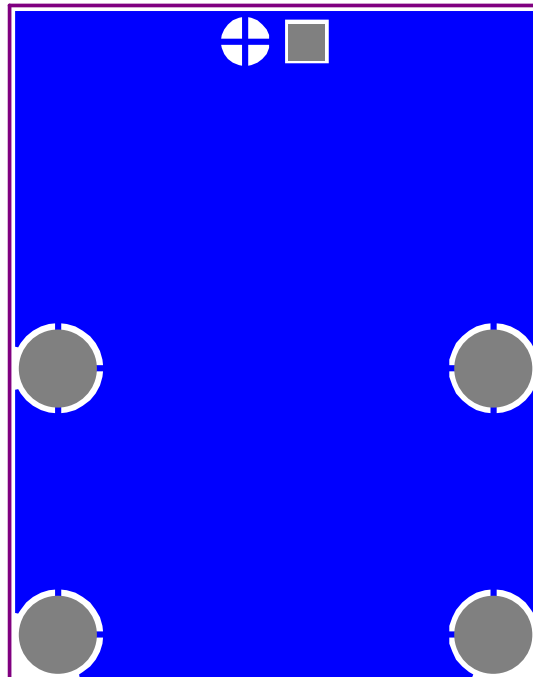

Figure 8: Bottom Layer



6 Ordering & Contact Information

Ordering Code	Description
AS5172B-TS_EK_AB	AS5172B Eval Kit Adapter Board

Buy our products or get free samples online at:

www.ams.com/ICdirect

Technical Support is available at:

www.ams.com/Technical-Support

Provide feedback about this document at:

www.ams.com/Document-Feedback

For further information and requests, e-mail us at:

ams_sales@ams.com

For sales offices, distributors and representatives, please visit:

www.ams.com/contact

Headquarters

ams AG
Tobelbaderstrasse 30
8141 Premstaetten
Austria, Europe

Tel: +43 (0) 3136 500 0

Website: www.ams.com

7 Copyrights & Disclaimer

Copyright ams AG, Tobelbader Strasse 30, 8141 Premstaetten, Austria-Europe. Trademarks Registered. All rights reserved. The material herein may not be reproduced, adapted, merged, translated, stored, or used without the prior written consent of the copyright owner.

Demo Kits, Evaluation Kits and Reference Designs are provided to recipient on an “as is” basis for demonstration and evaluation purposes only and are not considered to be finished end-products intended and fit for general consumer use, commercial applications and applications with special requirements such as but not limited to medical equipment or automotive applications. Demo Kits, Evaluation Kits and Reference Designs have not been tested for compliance with electromagnetic compatibility (EMC) standards and directives, unless otherwise specified. Demo Kits, Evaluation Kits and Reference Designs shall be used by qualified personnel only.

ams AG reserves the right to change functionality and price of Demo Kits, Evaluation Kits and Reference Designs at any time and without notice.

Any express or implied warranties, including, but not limited to the implied warranties of merchantability and fitness for a particular purpose are disclaimed. Any claims and demands and any direct, indirect, incidental, special, exemplary or consequential damages arising from the inadequacy of the provided Demo Kits, Evaluation Kits and Reference Designs or incurred losses of any kind (e.g. loss of use, data or profits or business interruption however caused) as a consequence of their use are excluded.

ams AG shall not be liable to recipient or any third party for any damages, including but not limited to personal injury, property damage, loss of profits, loss of use, interruption of business or indirect, special, incidental or consequential damages, of any kind, in connection with or arising out of the furnishing, performance or use of the technical data herein. No obligation or liability to recipient or any third party shall arise or flow out of ams AG rendering of technical or other services.

8 Revision Information

Changes from previous version to current revision 1-10 (2017-Oct-16)	Page
Initial version 1-00	

Note: Page numbers for the previous version may differ from page numbers in the current revision.
Correction of typographical errors is not explicitly mentioned.