

# 1143AA-822J=P3

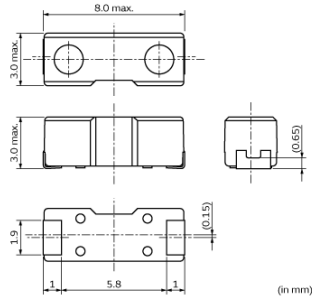

## Appearance & Shape



## Features

### Features

- High reliability conforms to automotive applications.
- Encapsulated core and winding for anti-shock proof.
- High Q and high sensitivity due to optimized magnetic material and electrode structure.
- Wide inductance range for design flexibility.
- Applicable to reflow soldering.
- AEC-Q200 compliant

### Applications

- Suitable as a Transponder Antenna Coil for TPMS and Keyless Entry System. (Vehicle application)
- Wide operating temperature range :- 40 ~ + 125°C

## Packaging Information

Packaging	Specifications	Minimum Order Quantity
-	330mm Embossed Tape	1500

### Attention

- 1.This datasheet is downloaded from the website of Murata Manufacturing Co., Ltd. Therefore, it's specifications are subject to change or our products in it may be discontinued without advance notice. Please check with our sales representatives or product engineers before ordering.
- 2.This datasheet has only typical specifications because there is no space for detailed specifications.  
Therefore, please review our product specifications or consult the approval sheet for product specifications before ordering.

# 1143AA-822J=P3

## Specifications

Series	SA3M08
Size(LxWxT)	8.0×3.0×3.0mm
Test Frequency	125kHz
Inductance	8.2mH
Unloaded Q(min.)	30
Inductance Tolerance	±5%
Operating Temperature Range	-40°C to 125°C

### Attention

- 1.This datasheet is downloaded from the website of Murata Manufacturing Co., Ltd. Therefore, it's specifications are subject to change or our products in it may be discontinued without advance notice. Please check with our sales representatives or product engineers before ordering.
- 2.This datasheet has only typical specifications because there is no space for detailed specifications.  
Therefore, please review our product specifications or consult the approval sheet for product specifications before ordering.

# 1143AA-822J=P3

## Product Data

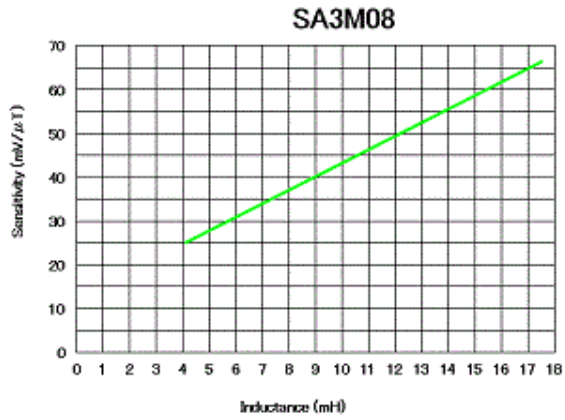

Sensitivity graph

**Attention**

- 1.This datasheet is downloaded from the website of Murata Manufacturing Co., Ltd. Therefore, it's specifications are subject to change or our products in it may be discontinued without advance notice. Please check with our sales representatives or product engineers before ordering.
- 2.This datasheet has only typical specifications because there is no space for detailed specifications.  
Therefore, please review our product specifications or consult the approval sheet for product specifications before ordering.