

348461-1 ✓ ACTIVE

AMP | Econoseal

TE Internal #: 348461-1

Silicone, Gray, -40 – 180 °C [-40 – 356 °F] Operating Temperature,
Econoseal

[View on TE.com >](#)



Connectors > Connector Accessories > Connector Seals & Cavity Plugs

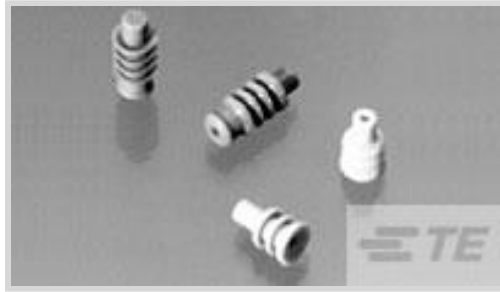

Primary Product Material: **Silicone**

Primary Product Color: **Gray**

Operating Temperature (Max): 65 °C, 70 °C, 75 °C, 80 °C, 85 °C, 90 °C, 100 °C, 105 °C, 110 °C, 120 °C, 125 °C, 130 °C, 140 °C, 150 °C, 155 °C, 170 °C, 180 °C [149 °F, 158 °F, 167 °F, 176 °F, 185 °F, 194 °F, 212 °F, 221 °F, 230 °F, 248 °F, 257 °F, 266 °F, 284 °F, 302 °F, 311 °F, 338 °F, 356 °F]

Operating Temperature Range: -40 – 180 °C [-40 – 356 °F]

Features

Body Features

Primary Product Material	Silicone
Primary Product Color	Gray

Usage Conditions

Operating Temperature (Max)	65 °C, 70 °C, 75 °C, 80 °C, 85 °C, 90 °C, 100 °C, 105 °C, 110 °C, 120 °C, 125 °C, 130 °C, 140 °C, 150 °C, 155 °C, 170 °C, 180 °C [149 °F][158 °F][167 °F][176 °F][185 °F][194 °F][212 °F][221 °F][230 °F][248 °F][257 °F][266 °F][284 °F][302 °F][311 °F][338 °F][356 °F]
Operating Temperature Range	-40 – 180 °C[-40 – 356 °F]

Packaging Features

Packaging Quantity	5000
Packaging Method	Bag

Product Compliance

[For compliance documentation, visit the product page on TE.com>](#)

EU RoHS Directive 2011/65/EU	Compliant
EU ELV Directive 2000/53/EC	Compliant
China RoHS 2 Directive MIIT Order No 32, 2016	No Restricted Materials Above Threshold
EU REACH Regulation (EC) No. 1907/2006	

Current ECHA Candidate List: JUNE 2023

(235)

Candidate List Declared Against: JUN 2020

(209)

Does not contain REACH SVHC

Halogen Content

Low Halogen - Br, Cl, F, I < 900 ppm per homogenous material. Also BFR/CFR/PVC Free

Solder Process Capability

Not applicable for solder process capability

Product Compliance Disclaimer

This information is provided based on reasonable inquiry of our suppliers and represents our current actual knowledge based on the information they provided. This information is subject to change. The part numbers that TE has identified as EU RoHS compliant have a maximum concentration of 0.1% by weight in homogenous materials for lead, hexavalent chromium, mercury, PBB, PBDE, DBP, BBP, DEHP, DIBP, and 0.01% for cadmium, or qualify for an exemption to these limits as defined in the Annexes of Directive 2011/65/EU (RoHS2). Finished electrical and electronic equipment products will be CE marked as required by Directive 2011/65/EU. Components may not be CE marked. Additionally, the part numbers that TE has identified as EU ELV compliant have a maximum concentration of 0.1% by weight in homogenous materials for lead, hexavalent chromium, and mercury, and 0.01% for cadmium, or qualify for an exemption to these limits as defined in the Annexes of Directive 2000/53/EC (ELV). Regarding the REACH Regulation, the information TE provides on SVHC in articles for this part number is based on the latest European Chemicals Agency (ECHA) 'Guidance on requirements for substances in articles' posted at this URL: <https://echa.europa.eu/guidance-documents/guidance-on-reach>

Compatible Parts



Also in the Series | Econoseal

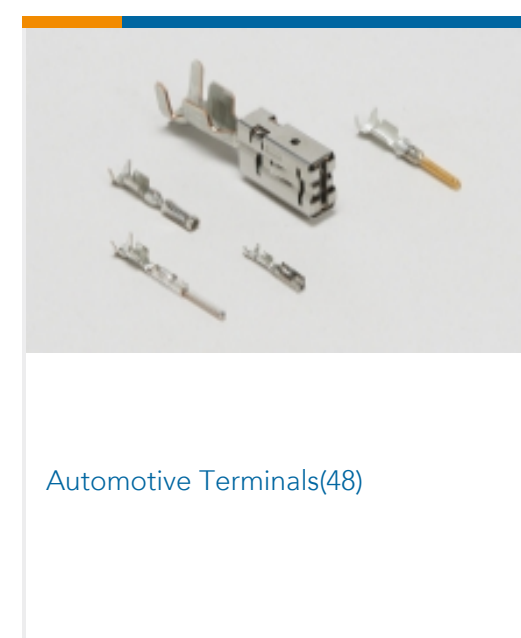
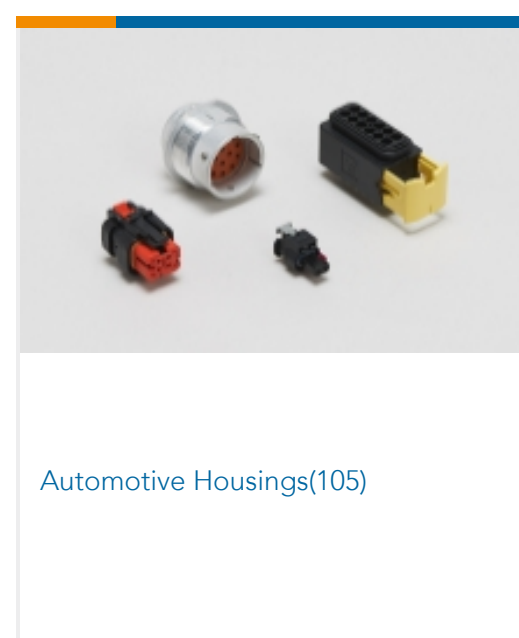
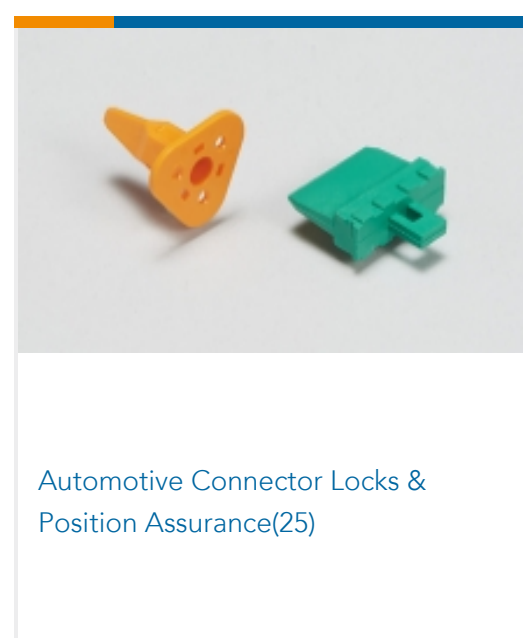

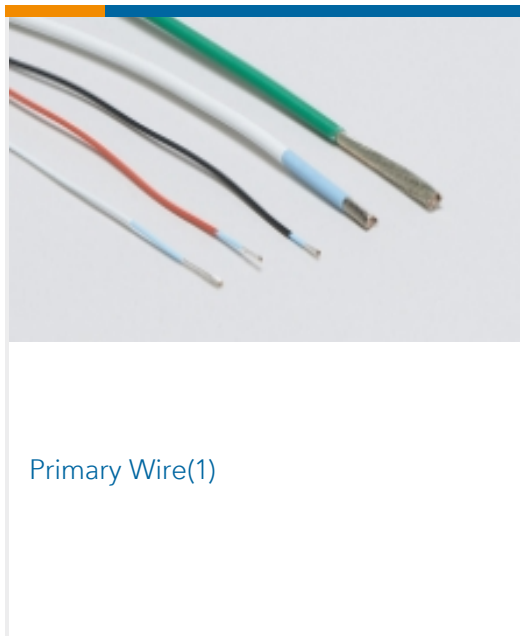
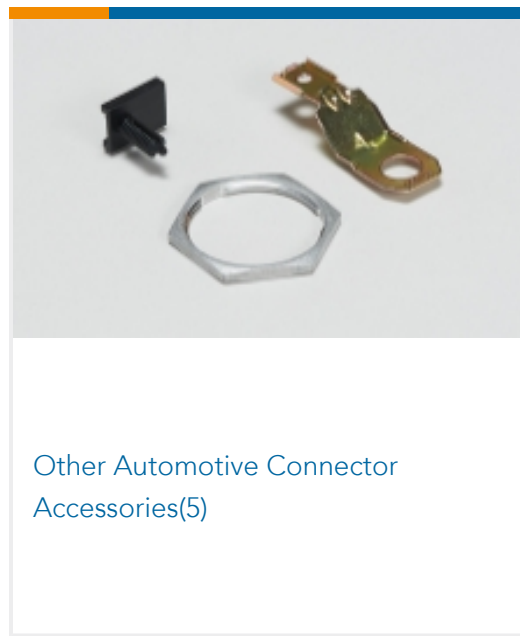
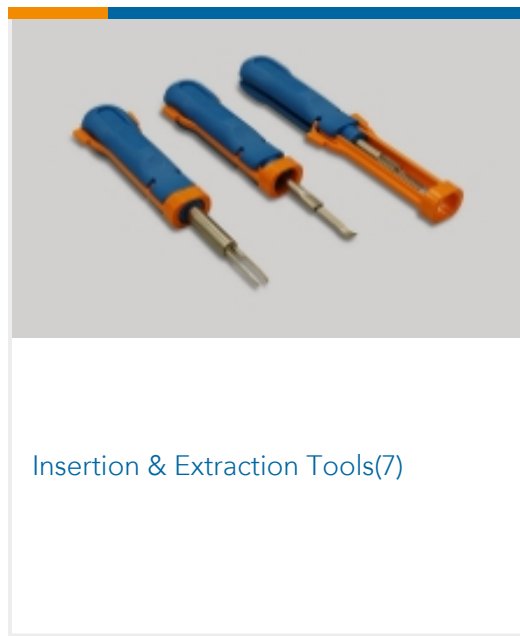
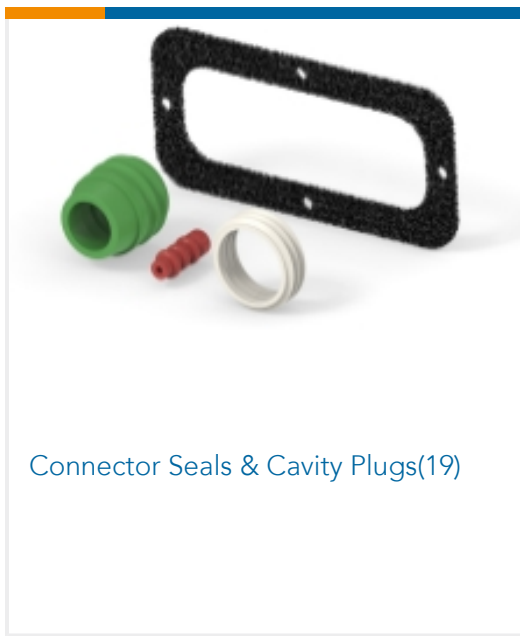

Customers Also Bought

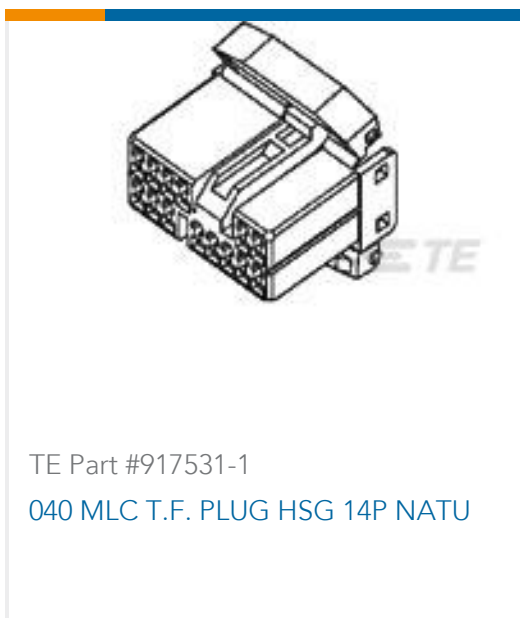

Documents



Product Drawings

ECON 3 LC PLUG SILIC

English

CAD Files

Customer View Model

[ENG_CVM_348461-1_A.3d_igs.zip](#)

English

Customer View Model

[ENG_CVM_348461-1_A.3d_stp.zip](#)

English

Customer View Model

[ENG_CVM_348461-1_A.2d_dxf.zip](#)

English

3D PDF

English

By downloading the CAD file I accept and agree to the [Terms and Conditions](#) of use.