

MFG. ENG.	APPROVED BY:	DATE:	QA	APPROVED BY:	DATE:
-----------	--------------	-------	----	--------------	-------

ASS'Y P/N	CONTACT QTY.	CABLE O.D. RANGE
W18280-2SG-P-311	2	0.09 - 0.14 [2.3 - 3.6]
W18280-2SG-P-315	2	0.15 - 0.17 [3.8 - 4.3]
W18280-2SG-P-318	2	0.18 - 0.20 [4.6 - 5.1]
W18280-3SG-P-311	3	0.09 - 0.14 [2.3 - 3.6]
W18280-3SG-P-315	3	0.15 - 0.17 [3.8 - 4.3]
W18280-3SG-P-318	3	0.18 - 0.20 [4.6 - 5.1]
W18280-XSG-P-3XX		

NOTES:

1. ALL PARTS ARE BULK PACKED.
2. REFER TO DRAWING HPMCSTD FOR CONTACT PATTERNS.
3. ALL DIMENSIONS ARE REFERENCE ONLY IN INCHES [mm], WITHIN ±0.015 UNLESS OTHERWISE NOTED.

OF CONTACTS — GROMMET SIZE = CABLE O.D. RANGE:
 311 = 0.09 - 0.14 [2.3 - 3.6]
 315 = 0.15 - 0.17 [3.8 - 4.3]
 318 = 0.18 - 0.20 [4.6 - 5.1]

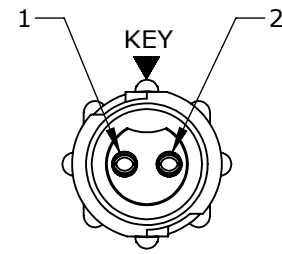

FACE VIEW
W18280-2SG-P-3XX

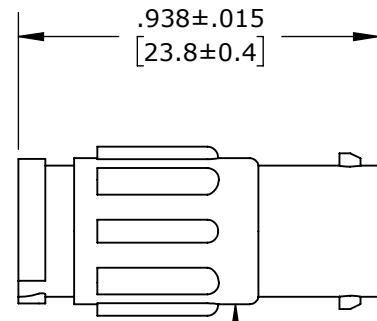

CABLE TO CABLE HOUSING
MAT'L: HOUSING -THERMOPLASTIC, BLACK

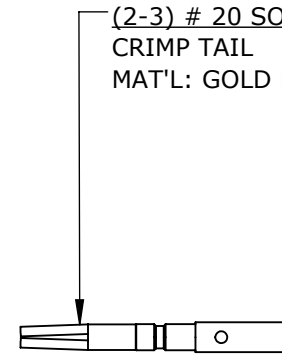

(2-3) # 20 SOCKET CONTACTS
CRIMP TAIL
MAT'L: GOLD PLATED, COPPER ALLOY

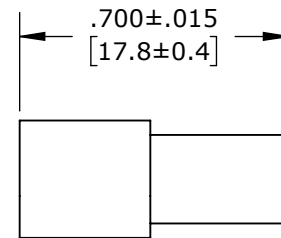

GROMMET
MAT'L: ELASTOMER, BLACK
SEE TABLE FOR CABLE O.D. SIZE OPTIONS

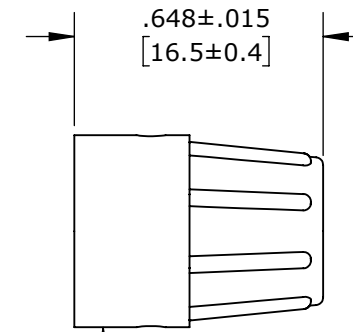

BACKSHELL
MAT'L: THERMOPLASTIC, BLACK

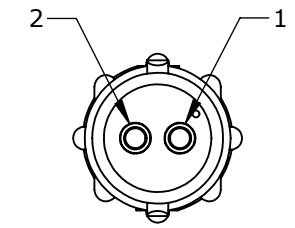

WIRING VIEW
W18280-2SG-P-3XX

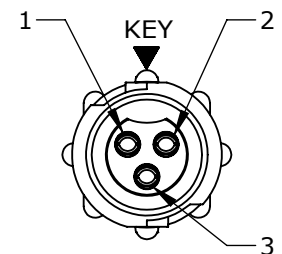

FACE VIEW
W18280-3SG-P-3XX

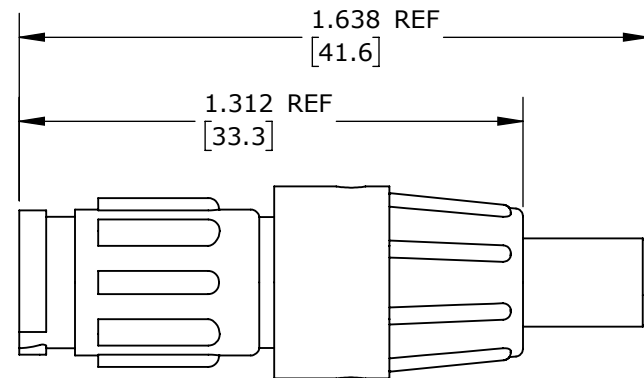

ASSEMBLED VIEW
FOR CUSTOMER REF. ONLY

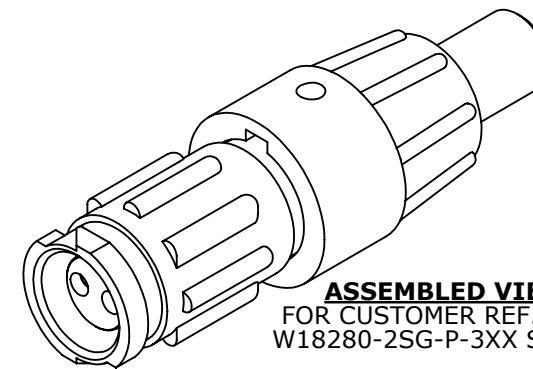

ASSEMBLED VIEW
FOR CUSTOMER REF. ONLY
W18280-2SG-P-3XX SHOWN

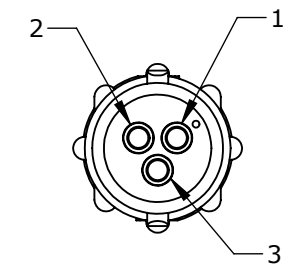

WIRING VIEW
W18280-3SG-P-3XX

CUSTOMER APPROVAL

THIS DOCUMENT CONTAINS CONFIDENTIAL INFORMATION PROPRIETARY TO CONXALL CORPORATION. ANY REPRODUCTION, DISCLOSURE, OR USE OF THIS DOCUMENT /INFORMATION IS EXPRESSLY PROHIBITED UNLESS AUTHORIZED IN WRITING BY CONXALL CORPORATION.

APPROVED BY: _____
DATE: _____

RoHS COMPLIANT

DIMENSIONS IS BRACKETS [] ARE METRIC

PRELIMINARY

0A	JGK	8/22/19	DRAWING CREATED FOR PDR #18004.		
REV.	INIT.	DATE	DESCRIPTION		
			ALL INFORMATION ILLUSTRATED IS THE PROPERTY OF CONXALL CORPORATION. UNAUTHORIZED DUPLICATION OR DISTRIBUTION OF THIS DOCUMENT IS PROHIBITED. ALL UNITS ARE IN FEET, INCHES, FRACTION OF INCHES AND DECIMALS. UNLESS OTHERWISE SPECIFIED TOLERANCES: 3 PLACE DECIMALS ±.005 ANGLES ±1° FRACTIONS ±1/16 ▽ - CRITICAL CHARACTERISTIC FLAG PER SPEC. XXXX	ORIG. DRAWN BY: JGK DATE: 8/22/19 CHECKED BY: APPROVED BY:	 601 E. WILDWOOD VILLA PARK, IL 60181 TITLE: CABLE TO CABLE CONN. ASS'Y (2-3) #20 SOCKET CONTACTS, CRIMP INSTA-CLICK, MICRO-CON-X STANDARD PRODUCT CUSTOMER:
SCALE	SIZE	SHEET			
NTS	B	1 OF 1			
FILE:	DIRECTORY:	PART NUMBER:	REV		
W18280-XSG-P-3XX	SLW	W18280-XSG-P-3XX	0A		

CUSTOMER PRINT

PART NUMBER: W18280-XSG-P-3XX