



Micro Commercial Components

Micro Commercial Components
 20736 Marilla Street Chatsworth
 CA 91311
 Phone: (818) 701-4933
 Fax: (818) 701-4939

**EGP20A
 THRU
 EGP20K**

**2.0 Amp Glass
 Passivated High
 Efficient Rectifiers
 50 to 800 Volts**

Features

- Case Material: Molded Plastic. UL Flammability Classification Rating 94V-0 and MSL rating 1
- Superfast recovery time for high efficiency
- Glass passivated cavity-free junction
- Lead Free Finish/RoHS Compliant (Note1) ("P" Suffix designates Compliant. See ordering information)

Maximum Ratings

- Operating Temperature: -55°C to +150°C
- Storage Temperature: -55°C to +150°C
- Typical Thermal Resistance: 40°C/W Junction to Ambient

MCC Part Number	Maximum Recurrent Peak Reverse Voltage	Maximum RMS Voltage	Maximum DC Blocking Voltage
EGP20A	50V	35V	50V
EGP20B	100V	70V	100V
EGP20D	200V	140V	200V
EGP20F	300V	210V	300V
EGP20G	400V	280V	400V
EGP20J	600V	420V	600V
EGP20K	800V	560V	800V

Electrical Characteristics @ 25°C Unless Otherwise Specified

Maximum Average Forward Current	$I_{F(AV)}$	2.0 A	$T_A = 55^\circ\text{C}$
Peak Forward Surge Current	I_{FSM}	75A	8.3ms, half sine
Maximum Instantaneous Forward Voltage	V_F	EGP20A-20D: 1.00V	$I_{FM} = 2.0A;$
		EGP20F-20G: 1.25V	
		EGP20J-20K: 1.70V	
Maximum DC Reverse Current At Rated DC Blocking Voltage	I_R	5.0uA 100uA	$T_A = 25^\circ\text{C}$ $T_A = 125^\circ\text{C}$
Maximum Reverse Recovery Time	T_{rr}	50nS 75nS	$I_F=0.5A, I_R=1.0A,$ $I_{rr}=0.25A$
Typical Junction Capacitance	C_J	70pF 45pF	Measured at 1.0MHz, $V_R=4.0V$

Note: 1. High Temperature Solder Exemption Applied, see EU Directive Annex 7.

DO-15

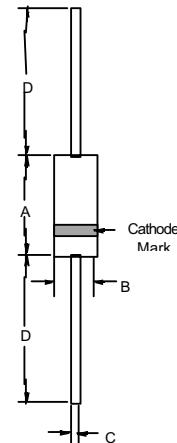

DIM	DIMENSIONS				NOTE
	INCHES		MM		
	MIN	MAX	MIN	MAX	
A	.230	.300	5.80	7.60	
B	.104	.140	2.60	3.60	
C	.026	.034	.70	.90	
D	1.000	---	25.40	---	

EGP20A thru EGP20K



Micro Commercial Components

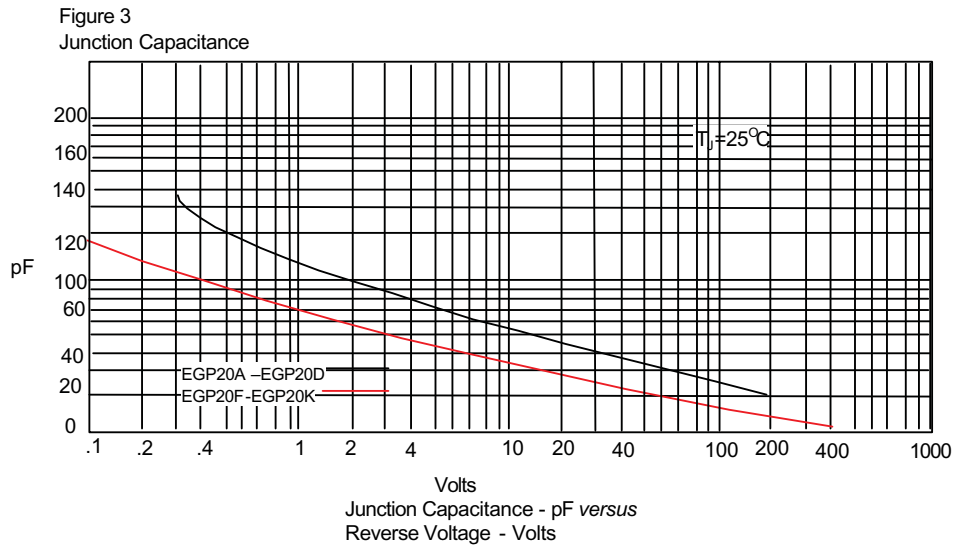
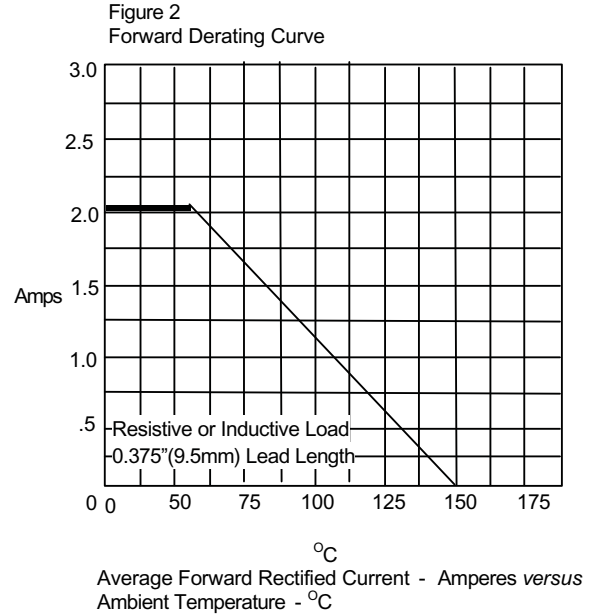
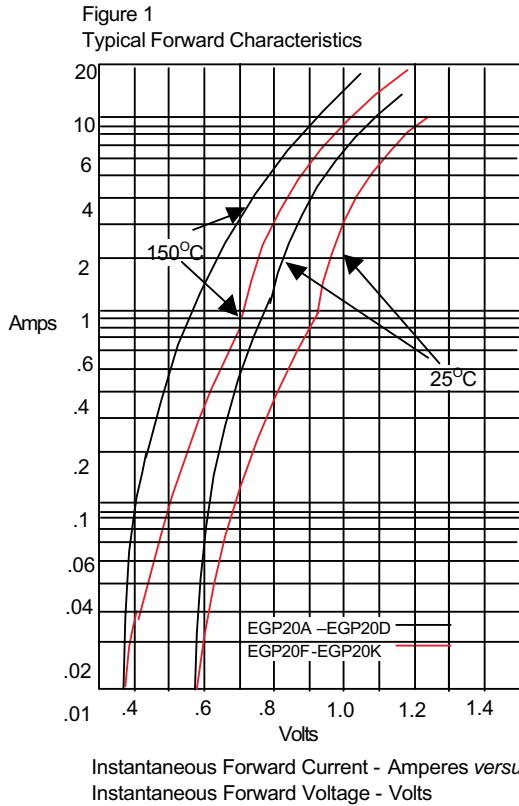

EGP20A thru EGP20K

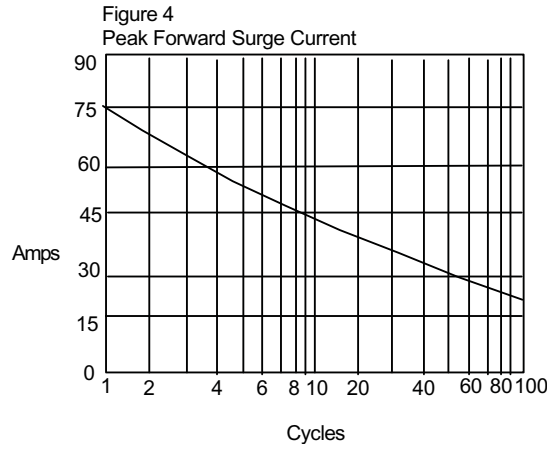

Peak Forward Surge Current - Amperes versus Number Of Cycles At 60Hz - Cycles

Figure 5
Reverse Recovery Time Characteristic And Test Circuit Diagram

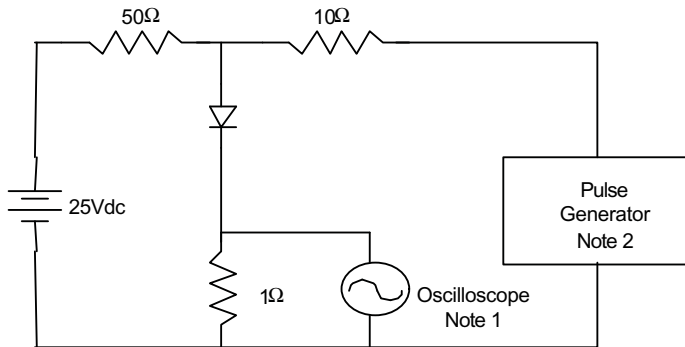

- Notes:
1. Rise Time = 7ns max.
Input impedance = 1 megohm, 22pF
 2. Rise Time = 10ns max.
Source impedance = 50 ohms
 3. Resistors are non-inductive

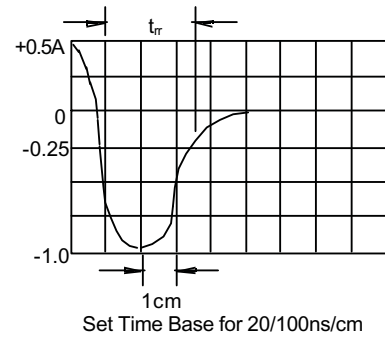



Micro Commercial Components

Ordering Information

Device	Packing
(Part Number)-TP	Tape&Reel;4Kpcs/Reel
(Part Number)-BP	Bulk;500pcs/Box

*****IMPORTANT NOTICE*****

Micro Commercial Components Corp. reserves the right to make changes without further notice to any product herein to make corrections, modifications, enhancements, improvements, or other changes. *Micro Commercial Components Corp.* does not assume any liability arising out of the application or use of any product described herein; neither does it convey any license under its patent rights, nor the rights of others. The user of products in such applications shall assume all risks of such use and will agree to hold *Micro Commercial Components Corp.* and all the companies whose products are represented on our website, harmless against all damages.

*****APPLICATIONS DISCLAIMER*****

Products offer by *Micro Commercial Components Corp.* are not intended for use in Medical, Aerospace or Military Applications.