



# PN KEY ENGINEERING PN

**E 4 5 2 X X X X X X X X X X**

E - Packing without bag  
W - Single Packing

Number of wires:  
2 - 2 Wires + Earth

Cable type:  
See Table

Head Colour:  
G - Grey  
N - Black  
A - CSA-UL Black  
B - CSA-UL Grey

Cable Length in[cm]  
050 = 50cm  
300 = 300cm  
10K = 1000cm

Wiring Configuration:  
See sheet 3

Voltage and Led Colour

|          |            |             |
|----------|------------|-------------|
| Red Led: | Green Led: | Yellow Led: |
| 1 = 12V  | A = 12V    | G = 12V     |
| 2 = 24V  | B = 24V    | H = 24V     |
| 3 = 48V  | C = 48V    | K = 48V     |
| 4 = 115V | D = 115V   | L = 115V    |
| 5 = 230V | E = 230V   | M = 230V    |

Earth PIN location (see insert orientation table):  
1 = Double Earth on H6 & H12  
2 = Earth on H12  
3 = Earth on H3  
4 = Double Earth on H3 & H9  
6 = Earth on H6  
9 = Earth on H9

Type of Gasket and Screw (see sheet 1):  
1 = NBR Profile Gasket + Fixing Screw M3x25mm  
2 = NBR Flat Gasket + Fixing Screw M3x25mm  
3 = Silicone Profile Gasket + Fixing Screw M3x25mm  
4 = Silicone Flat Gasket + Fixing Screw M3x25mm  
P = NBR Integrated Gasket + Fixing Screw with Washer M3x27mm Assembled on Connector  
R = NBR Integrated Gasket + Fixing Screw with Washer M3x27mm NOT Assembled on Connector  
T = NBR Profile Gasket + Fixing Screw with Washer M3x27mm

| CABLE TYPE | NO. OF WIRES | CROSS SECTION | CABLE O.D.  | CABLE JACKET | UL       | CSA       | STATIC: TEMP. / BENDING RADIUS | DYNAMIC: TEMP. / BENDING RADIUS | SHIELD |
|------------|--------------|---------------|-------------|--------------|----------|-----------|--------------------------------|---------------------------------|--------|
| A2         | 3            | AWG 20        | 5.6mm±0.2   | PVC BLACK    | UL 2661  | CSA C22.2 | -30°C to +105°C, 10xO.D.       | -5°C to +105°C, 15xO.D.         | -      |
| A3         | 3            | AWG 18        | 6.5mm±0.25  | PVC BLACK    | UL 2661  | CSA C22.2 | -30°C to +105°C, 10xO.D.       | -5°C to +105°C, 15xO.D.         | -      |
| B2         | 3            | AWG 20        | 5.6mm±0.2   | PUR BLACK    | UL 20668 | CSA C22.2 | -40°C to +90°C, 5xO.D.         | -25°C to +90°C, 10xO.D.         | -      |
| B3         | 3            | AWG 18        | 6.5mm±0.2   | PUR BLACK    | UL 20668 | CSA C22.2 | -40°C to +90°C, 5xO.D.         | -25°C to +90°C, 10xO.D.         | -      |
| F4         | 3            | 1mm²          | 7.1mm+0.2   | PVC GREY     | -        | -         | -15°C to +70°C, 10xO.D.        | -5°C to +60°C, 15xO.D.          | -      |
| I0         | 3            | 1mm²          | 7.6mm±0.2   | PVC GREY     | -        | -         | -25°C to +70°C, 10xO.D.        | -5°C to +70°C, 15xO.D.          | YES    |
| I2         | 3            | 0.5mm²        | 5.5mm+0.3   | PVC GREY     | -        | -         | -25°C to +70°C, 10xO.D.        | -5°C to +70°C, 15xO.D.          | -      |
| I3         | 3            | 0.75mm²       | 6.0mm±0.2   | PVC GREY     | -        | -         | -25°C to +70°C, 10xO.D.        | -5°C to +70°C, 15xO.D.          | -      |
| I4         | 3            | 1mm²          | 7.1mm+0.2   | PVC GREY     | -        | -         | -25°C to +70°C, 10xO.D.        | -5°C to +70°C, 15xO.D.          | -      |
| N2         | 3            | 0.5mm²        | 5.6mm±0.7   | PVC BLACK    | -        | -         | -20°C to +70°C, 3xO.D.         | -15°C to +70°C, 5xO.D.          | -      |
| N3         | 3            | 0.75mm²       | 6.8mm±0.8   | PVC BLACK    | -        | -         | -20°C to +70°C, 3xO.D.         | -15°C to +70°C, 5xO.D.          | -      |
| N4         | 3            | 1mm²          | 7.15mm±0.85 | PVC BLACK    | -        | -         | -20°C to +70°C, 3xO.D.         | -15°C to +70°C, 5xO.D.          | -      |
| P1         | 3            | 0.34mm²       | 5.3mm±0.2   | PUR BLACK    | -        | -         | -25°C to +80°C, 10xO.D.        | -5°C to +80°C, 15xO.D.          | -      |
| P2         | 3            | 0.5mm²        | 5.5mm+0.3   | PUR BLACK    | -        | -         | -40°C to +90°C, 7.5xO.D.       | -15°C to +90°C, 12.5xO.D.       | -      |
| P3         | 3            | 0.75mm²       | 6.5mm±0.2   | PUR BLACK    | -        | -         | -40°C to +90°C, 7.5xO.D.       | -15°C to +90°C, 12.5xO.D.       | -      |
| R4         | 3            | 1mm²          | 7.1mm±0.2   | TPR HF BLACK | -        | -         | -                              | -                               | -      |
| Y3         | 3            | 0.75mm²       | 6.5mm±0.2   | SILICONE RED | -        | -         | -60°C to +180°C, 15xO.D.       | -                               | -      |

## Notes:

- Please see excel sheet 1210502000\_PDP for currently configured part numbers.
- Drawing is a replacement for: SD-121050-001

|         |   |                                       |                        |         |                            |                    |                |          |          |
|---------|---|---------------------------------------|------------------------|---------|----------------------------|--------------------|----------------|----------|----------|
| SYMBOLS | THIS DRAWING CONTAINS INFORMATION THAT IS PROPRIETARY TO MOLEX ELECTRONIC TECHNOLOGIES, LLC AND SHOULD NOT BE USED WITHOUT WRITTEN PERMISSION |                                       | CURRENT REV DESC:      |         | <b>molex</b>               |                    |                |          |          |
|         | ▽ = 0   | mm                                    | SCALE                  | 1:1     |                            |                    |                |          |          |
|         | ▽ = 0   | GENERAL TOLERANCES (UNLESS SPECIFIED) |                        |         |                            |                    |                |          |          |
|         | ▽ = 0   | ANGULAR TOL                           | ±                      | '       |                            |                    |                |          |          |
| ▽ = 0   | 4 PLACES  | ±                                     |                        |         | EC NO: 603741              |                    |                |          |          |
| ▽ = 0   | 3 PLACES  | ±                                     |                        |         | DRWN: APAWLAK01 2018/07/13 |                    |                |          |          |
| ▽ = 0   | 2 PLACES  | ±                                     |                        |         | CHK'D: RSILLER 2018/08/31  |                    |                |          |          |
| ▽ = 0   | 1 PLACE   | ±                                     |                        |         | APPR: RSILLER 2018/08/31   |                    |                |          |          |
| ▽ = 0   | 0 PLACES  | ±                                     |                        |         | INITIAL REVISION:          |                    |                |          |          |
| ■ = 0   | DRAFT WHERE APPLICABLE MUST REMAIN WITHIN DIMENSIONS  |                                       | THIRD ANGLE PROJECTION | DRAWING | SERIES                     | DOCUMENT NUMBER    | DOC TYPE       | DOC PART | REVISION |
| ▽ = 0   |   |                                       |                        | A3-SIZE | 121050                     | 1210502000         | PSD            | 000      | A        |
|         |   |                                       |                        |         |                            | SEE 1210502000_PDP | GENERAL MARKET |          | 2 OF 3   |

# WIRING DIAGRAMS

ELECTRICAL DIAGRAM 00



ELECTRICAL DIAGRAM A1

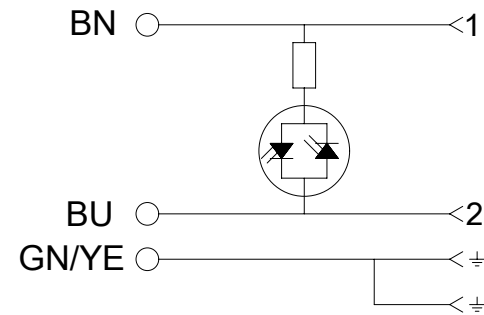

ELECTRICAL DIAGRAM C3

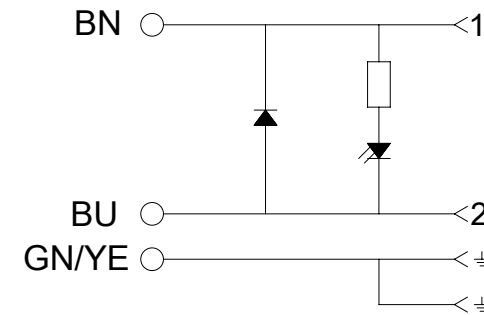

ELECTRICAL DIAGRAM C4

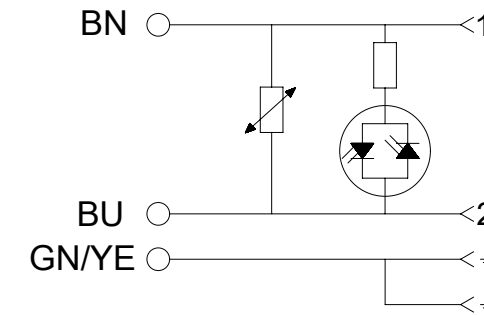

ELECTRICAL DIAGRAM C7



ELECTRICAL DIAGRAM D0

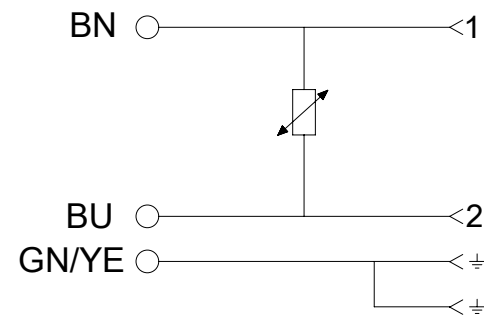

ELECTRICAL DIAGRAM E0

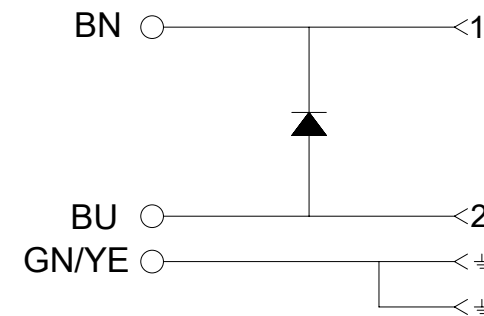

ELECTRICAL DIAGRAM R0

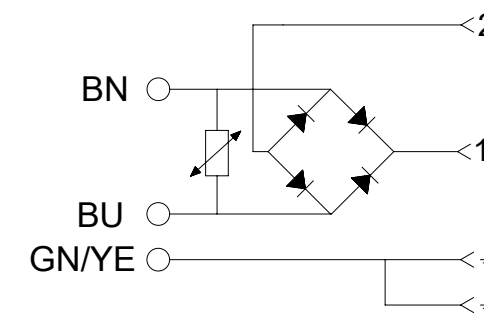

ELECTRICAL DIAGRAM R2



ELECTRICAL DIAGRAM S0

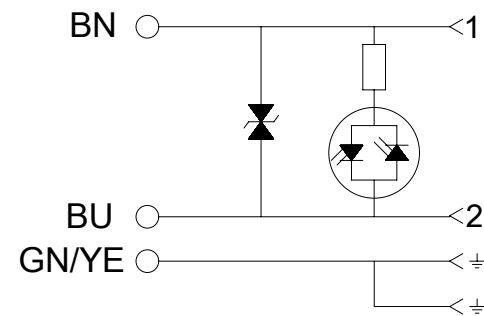

ELECTRICAL DIAGRAM S1

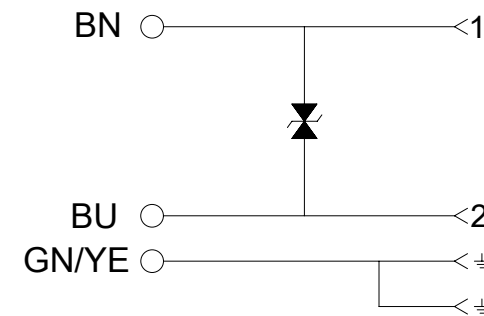

ELECTRICAL DIAGRAM S3

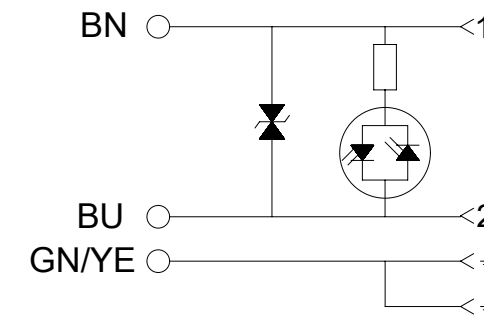

ELECTRICAL DIAGRAM NS



Technical Spec:  
 Supply Voltage: See PN KEY  
 Max. current: 5A; A1-C4-S0  
 1,5A; R2  
 Contact Resistance: ≤15milliohms max.  
 Operating Temperature:  
 with NBR Gasket: -40°C +90°C  
 with Silicone: -40°C +125°C

|   |                 |  |       |  |                            |  |         |  |  |  |              |            |
|---|-----------------|--|-------|--|----------------------------|--|---------|--|--|--|--------------|------------|
| THIS DRAWING CONTAINS INFORMATION THAT IS PROPRIETARY TO MOLEX ELECTRONIC TECHNOLOGIES, LLC AND SHOULD NOT BE USED WITHOUT WRITTEN PERMISSION |                 |  |       |  |                            |  |         |  |  |  |              |            |
| SYMBOLS   | DIMENSION UNITS |  | SCALE |  | CURRENT REV DESC:          |  |         |  |  |  |              |            |
|   | mm              |  | 1:1   |  |                            |  |         |  |  |  |              |            |
| GENERAL TOLERANCES (UNLESS SPECIFIED)   |                 |  |       |  | EC NO: 603741              |  |         |  | STANDARD E452 DIN FORM A EN 175301-803 |  |              |            |
| ANGULAR TOL ± °   |                 |  |       |  | DRWN: APAWLAK01 2018/07/13 |  |         |  |  |  |              |            |
| 4 PLACES ±  |                 |  |       |  | CHK'D: RSILLER 2018/08/31  |  |         |  | PRODUCT CUSTOMER DRAWING               |  |              |            |
| 3 PLACES ±  |                 |  |       |  | APPR: RSILLER 2018/08/31   |  |         |  |  |  |              |            |
| 2 PLACES ±  |                 |  |       |  | INITIAL REVISION:          |  |         |  | DOCUMENT NUMBER                        |  |              |            |
| 1 PLACE ±   |                 |  |       |  | DRWN: APAWLAK01 2018/07/13 |  |         |  |  |  |              | 1210502000 |
| 0 PLACES ±  |                 |  |       |  | APPR: RSILLER 2018/08/31   |  |         |  | DOC TYPE                               |  |              |            |
| DRAFT WHERE APPLICABLE MUST REMAIN WITHIN DIMENSIONS  |                 |  |       |  | THIRD ANGLE PROJECTION     |  | DRAWING |  |  |  |              | SERIES     |
|   |                 |  |       |  |                            |  | A3-SIZE |  | 121050                                 |  | REVISION     |            |
|   |                 |  |       |  |                            |  |         |  |  |  | PSD 000 A    |            |
|   |                 |  |       |  |                            |  |         |  | MATERIAL NUMBER                        |  | SHEET NUMBER |            |
|   |                 |  |       |  |                            |  |         |  | SEE 1210502000_PDP                     |  | 3 OF 3       |            |
|   |                 |  |       |  |                            |  |         |  | CUSTOMER                               |  |              |            |
|   |                 |  |       |  |                            |  |         |  | GENERAL MARKET                         |  |              |            |



|   |                                     |                                    |
|---|-------------------------------------|------------------------------------|
| DOUBLE EARTH ON 6H & 12H<br>E452XXXXXX1XXXX | EARTH PIN ON 12H<br>E452XXXXXX2XXXX | EARTH PIN ON 6H<br>E452XXXXXX6XXXX |
| DOUBLE EARTH ON 3H & 9H<br>E452XXXXXX4XXXX  | EARTH PIN ON 3H<br>E452XXXXXX3XXXX  | EARTH PIN ON 9H<br>E452XXXXXX9XXXX |

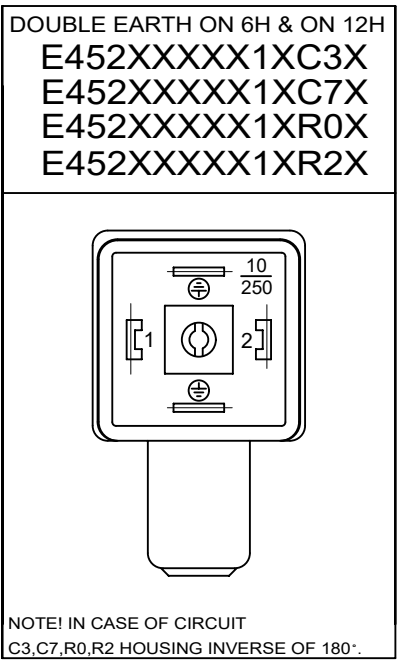

Table of length tolerances [mm]

| Over  | Up to and including | Tolerance (+) |
|-------|---------------------|---------------|
| 0     | 1000                | ±20           |
| 1000  | 3000                | ±30           |
| 3000  | 5000                | ±40           |
| 5000  | 10000               | ±50           |
| 10000 | 15000               | ±100          |
| 15000 | 20000               | ±150          |
| 20000 |                     | ±L/100        |

WIRING CONFIGURATION

|                              |                              |                              |
|------------------------------|------------------------------|------------------------------|
| <b>ELECTRICAL DIAGRAM R0</b> | <b>ELECTRICAL DIAGRAM C4</b> | <b>ELECTRICAL DIAGRAM S0</b> |
| <b>ELECTRICAL DIAGRAM S3</b> | <b>ELECTRICAL DIAGRAM A1</b> | <b>ELECTRICAL DIAGRAM C3</b> |
| <b>ELECTRICAL DIAGRAM E0</b> | <b>ELECTRICAL DIAGRAM R2</b> | <b>ELECTRICAL DIAGRAM C7</b> |
| <b>ELECTRICAL DIAGRAM S1</b> | <b>ELECTRICAL DIAGRAM 00</b> |                              |

NOTES:  
1. FOR HARNESS WITH GROUND ONLY IN:  
3H,6H,9H or 12H PIN 3 IS N/C.

THIS DRAWING CONTAINS INFORMATION THAT IS PROPRIETARY TO MOLEX ELECTRONIC TECHNOLOGIES, LLC AND SHOULD NOT BE USED WITHOUT WRITTEN PERMISSION

|  |                        |   |  |                          |                       |
|--|------------------------|---|--|--------------------------|-----------------------|
| DIMENSION UNITS: mm                                  | SCALE: NTS             | CURRENT REV DESC: REVISION CREATED FOR REMOVING PRE-RELEASE STAMP | <b>molex</b>                               |                          |                       |
| GENERAL TOLERANCES (UNLESS SPECIFIED)                |                        |   |  |                          |                       |
| 4 PLACES ±   | MM INCH                | EC NO: 714567   | E452XXXXXXXXXX<br>DIN FORM A EN 175301-803 |                          |                       |
| 3 PLACES ±   |                        | DRWN: SUGEEB 2022/07/18   | PRODUCT CUSTOMER DRAWING                   |                          |                       |
| 2 PLACES ±   |                        | CHK'D: GGA 2022/07/19   | DOCUMENT NUMBER: SD-121050-001             |                          |                       |
| 1 PLACE ±  |                        | APPR: GGA 2022/07/19  | DOC TYPE: PSD                              |                          |                       |
| 0 PLACES ±   |                        | INITIAL REVISION:   | DOC PART: 001                              |                          |                       |
| ANGULAR TOL ± °                                      |                        | DRWN: JMARSZALEK 2012/08/27                                       | REVISION: E1                               |                          |                       |
| DRAFT WHERE APPLICABLE MUST REMAIN WITHIN DIMENSIONS | FIRST ANGLE PROJECTION | APPR: MDYSZEWSKA 2012/08/20                                       | MATERIAL NUMBER: SEE TABLE                 | CUSTOMER: GENERAL MARKET | SHEET NUMBER: 1 OF 41 |

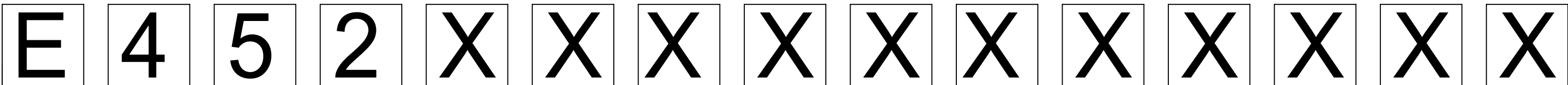

E - Packing without bags  
 W - Single packing  
 Q - Quick packing

NUMBER OF WIRES:  
 1=2 WIRES  
 2=2 WIRES + EARTH  
 3=3 WIRES + EARTH

CABLE TYPE  
 SEE SHEET 3 - TABLE 1

CABLE CROSS SECTION AREA  
 SEE SHEET 3 - TABLE 2

HEAD COLOUR:  
 N=BLACK;  
 A=CSA-UL BLACK;  
 B=CSA-UL GREY.

CABLE LENGTH IN CM  
 Eg.:050=50 CM, 300=300 CM, 10K=1000 CM.

EARTH PIN LOCATION:  
 1=DOUBLE EARTH ON 6H AND 12H,  
 2=EARTH ON 12H,  
 6=EARTH ON 6H.

TYPE OF GASKET AND SCREW:  
 1=NBR PROFILE GASKET + FIXING SCREWS (M3x25 mm).  
 2=NBR FLAT GASKET + FIXING SCREW (M3x25 mm).  
 3=SILICONE PROFILE GASKET + FIXING SCREW (M3x25 mm).  
 4=SILICON FLAT GASKET + FIXING SCREW (M3x25 mm).  
 P=INTEGRATED GASKET ASSEMBLED + FIXING SCREW WITH GROMMET ASSEMBLED ON CONNECTOR (M3x27 mm).  
 R=INTEGRATED GASKET + FIXING SCREW + GROMMET (M3x27 mm).  
 T=PROFILE GASKET + FIXING SCREW + GROMMET (M3x27 mm).

INTERNAL CIRCUIT  
 WIRING CONFIGURATION

VOLTAGE AND LED COLOUR:

|         |           |         |             |         |              |
|---------|-----------|---------|-------------|---------|--------------|
| 1= 12V  | } RED LED | A= 12V  | } GREEN LED | G= 12V  | } YELLOW LED |
| 2= 24V  |           | B= 24V  |             | H= 24V  |              |
| 3= 48V  |           | C= 48V  |             | K= 48V  |              |
| 4= 115V |           | D= 115V |             | L= 115V |              |
| 5= 230V |           | E= 230V |             | M= 230V |              |

|   |  |       |  |   |  |                        |  |                          |  |                          |  |  |  |
|---|--|-------|--|---|--|------------------------|--|--------------------------|--|--------------------------|--|--|--|
| THIS DRAWING CONTAINS INFORMATION THAT IS PROPRIETARY TO MOLEX ELECTRONIC TECHNOLOGIES, LLC AND SHOULD NOT BE USED WITHOUT WRITTEN PERMISSION |  |       |  |   |  |                        |  |                          |  |                          |  |  |  |
| DIMENSION UNITS   |  | SCALE |  | CURRENT REV DESC: REVISION CREATED FOR REMOVING PRE-RELEASE STAMP |  |                        |  |                          |  |                          |  |  |  |
| mm  |  | NTS   |  |   |  |                        |  |                          |  |                          |  |  |  |
| GENERAL TOLERANCES (UNLESS SPECIFIED)   |  |       |  | EC NO: 714567   |  | DRWN: SUGEEB           |  | 2022/07/18               |  | E452XXXXXXXXXX           |  |  |  |
|   |  |       |  | CHK'D: GGA  |  | 2022/07/19             |  | DIN FORM A EN 175301-803 |  | PRODUCT CUSTOMER DRAWING |  |  |  |
|   |  |       |  | APPR: GGA   |  | 2022/07/19             |  | DOCUMENT NUMBER          |  | DOC TYPE                 |  |  |  |
| 4 PLACES ±  |  |       |  | INITIAL REVISION:   |  | DRWN: JMARSZALEK       |  | 2012/08/27               |  | SD-121050-001            |  |  |  |
| 3 PLACES ±  |  |       |  | APPR: MDYSZEWSKA  |  | 2012/08/20             |  | PSD                      |  | 001                      |  |  |  |
| 2 PLACES ±  |  |       |  | DRAFT WHERE APPLICABLE MUST REMAIN WITHIN DIMENSIONS              |  | FIRST ANGLE PROJECTION |  | DRAWING                  |  | SERIES                   |  |  |  |
| 1 PLACE ±   |  |       |  | A3-SIZE   |  | 121050                 |  | MATERIAL NUMBER          |  | CUSTOMER                 |  |  |  |
| 0 PLACES ±  |  |       |  | SEE TABLE   |  | GENERAL MARKET         |  | SHEET NUMBER             |  | 2 OF 41                  |  |  |  |
| ANGULAR TOL ± °   |  |       |  |   |  |                        |  |                          |  |                          |  |  |  |

TABLE 2 - CABLES

| Molex PN Raw cable | Cable type | Cable code | Wires no. | Cross Section | Jacket material      | Jacket color | Diameter Ø [mm] | Wire colors           |
|--------------------|------------|------------|-----------|---------------|----------------------|--------------|-----------------|-----------------------|
| 1210180080         | I          | 0          | 3         | 1 mm²         | PVC CEI 2022 II O.R. | Grey         | 6.4±0.2         | BN, BU, GN/YE         |
| 1210180467         | A          | 2          | 2         | 20 AWG        | PVC CSA/UL 2661      | Black        | 5.4±0.2         | BN, BU                |
| 1210180128         | A          | 2          | 3         | 20 AWG        | PVC CSA/UL 2661      | Black        | 5.6±0.2         | BN, BU, GN/YE         |
| 1210180394         | A          | 2          | 4         | 20 AWG        | PVC CSA/UL 2661      | Black        | 6.2±0.25        | BN, BU, BK, GN/YE     |
| 1210180297         | B          | 2          | 2         | 20 AWG        | PUR CSA/UL 20668     | Black        | 5.6±0.2         | BN, BU                |
| 1210180126         | B          | 2          | 3         | 20 AWG        | PUR CSA/UL 20668     | Black        | 5.6±0.2         | BN, BU, GN/YE         |
| 1210180387         | B          | 2          | 4         | 20 AWG        | PUR CSA/UL 20668     | Black        | 6.3±0.2         | BN, BU, BK, GN/YE     |
| 1210180122         | D          | 2          | 3         | 0.5 mm²       | PVC CEI 20-20        | Grey         | 5.5±0.2         | BN, BU, GN/YE         |
| 1210180047         | I          | 2          | 2         | 0.5 mm²       | PVC CEI 2022 II O.R. | Grey         | 5.5+0.3/-0      | BN, BU                |
| 1210180284         | I          | 2          | 3         | 0.5 mm²       | PVC CEI 2022 II O.R. | Grey         | 5.5+0.3/-0      | BN, BU, GN/YE         |
| 1210180146         | I          | 2          | 4         | 0.5 mm²       | PVC CEI 2022 II O.R. | Grey         | 6.5±0.2         | BN, BU, BK, GN/YE     |
| 1210180177         | I          | 2          | 5         | 0.5 mm²       | PVC CEI 2022 II O.R. | Grey         | 7.0 +0.3/-0     | BN, BU, BK, WH, GN/YE |
| 1210180022         | N          | 2          | 2         | 0.5 mm²       | PVC H03VV-F          | Black        | 5.2±0.2         | BN, BU                |
| 1202092753         | N          | 2          | 3         | 0.5 mm²       | PVC H03VV-F          | Black        | 5.5±0.2         | BN, BU, GN/YE         |
| 1210180153         | N          | 2          | 4         | 0.5 mm²       | PVC H03VV-F          | Black        | 5.9±0.3         | BN, BU, BK, GN/YE     |
| 1210180046         | P          | 2          | 2         | 0.5 mm²       | PUR - BLEND          | Black        | 5.5±0.2         | BN, BU                |
| 1202092439         | P          | 2          | 3         | 0.5 mm²       | PUR - BLEND          | Black        | 5.5 +0.3/-0     | BN, BU, GN/YE         |
| 1210180302         | P          | 2          | 4         | 0.5 mm²       | PUR - BLEND          | Black        | 6.5±0.2         | BN, BU, BK, GN/YE     |
| 1202092215         | P          | 2          | 5         | 0.5 mm²       | PUR - BLEND          | Black        | 7+0.3/-0.1      | BN, BU, BK, WH, GN/YE |
| 1210180409         | A          | 3          | 2         | 18 AWG        | PVC CSA/UL 2661      | Black        | 6.2±0.25        | BN, BU                |
| 1210180129         | A          | 3          | 3         | 18 AWG        | PVC CSA/UL 2661      | Black        | 6.5±0.25        | BN, BU, GN/YE         |
| 1210180159         | A          | 3          | 4         | 18 AWG        | PVC CSA/UL 2661      | Black        | 7.0+0.3/-0      | BN, BU, BK, GN/YE     |
| 1210180464         | A          | 3          | 5         | 18 AWG        | PVC CSA/UL 2661      | Black        | 7.8±0.25        | BN, BU, BK, WH, GN/YE |
| 1210180351         | B          | 3          | 2         | 18 AWG        | PUR CSA/UL 20668     | Black        | 6.2±0.2         | BN, BU                |
| 1210180127         | B          | 3          | 3         | 18 AWG        | PUR CSA/UL 20668     | Black        | 6.5±0.2         | BN, BU, GN/YE         |
| 1210180160         | B          | 3          | 4         | 18 AWG        | PUR CSA/UL 20668     | Black        | 7±0.2           | BN, BU, BK, GN/YE     |
| 1210180463         | B          | 3          | 5         | 18 AWG        | PUR CSA/UL 20668     | Black        | 7.8±0.25        | BN, BU, BK, WH, GN/YE |
| 1210180073         | D          | 3          | 3         | 0.75 mm²      | PVC CEI 20-20        | Grey         | 6.5±0.2         | BN, BU, GN/YE         |
| 1210180145         | D          | 3          | 4         | 0.75 mm²      | PVC CEI 20-20        | Grey         | 7.1±0.2         | BN, BU, BK, GN/YE     |
| 1202098206         | I          | 3          | 2         | 0.75 mm²      | PVC CEI 2022 II O.R. | Grey         | 5.5±0.2         | BK1, BK2              |
| 1210180120         | I          | 3          | 3         | 0.75 mm²      | PVC CEI 2022 II O.R. | Grey         | 6.0±0.2         | BK1, BK2, BK3         |
| 1210180143         | I          | 3          | 4         | 0.75 mm²      | PVC CEI 2022 II O.R. | Grey         | 7.0±0.2         | BN, BU, BK, GN/YE     |
| 1210180032         | N          | 3          | 2         | 0.75 mm²      | PVC H05VV-F          | Black        | 6.2±0.2         | BN, BU                |
| 1210180069         | N          | 3          | 3         | 0.75 mm²      | PVC H05VV-F          | Black        | 6.5±0.2         | BN, BU, GN/YE         |
| 1210180144         | N          | 3          | 4         | 0.75 mm²      | PVC H05VV-F          | Black        | 7.1±0.2         | BN, BU, BK, GN/YE     |
| 1210180174         | N          | 3          | 5         | 0.75 mm²      | PVC H05VV-F          | Black        | 8.0+0.2/-0      | BN, BU, BK, GY, GN/YE |
| 1202094190         | P          | 3          | 2         | 0.75 mm²      | PUR - BLEND          | Black        | 6.5±0.2         | BN, BU                |
| 1210180071         | P          | 3          | 3         | 0.75 mm²      | PUR - BLEND          | Black        | 6.5±0.2         | BN, BU, GN/YE         |
| 1210180152         | P          | 3          | 4         | 0.75 mm²      | PUR - BLEND          | Black        | 7.0±0.2         | BN, BU, BK, GN/YE     |

TABLE 2 - CABLES

| Molex PN Raw cable | Cable type | Cable code | Wires no. | Cross Section | Jacket material      | Jacket color | Diameter Ø [mm] | Wire colors       |
|--------------------|------------|------------|-----------|---------------|----------------------|--------------|-----------------|-------------------|
| 1210180384         | R          | 3          | 3         | 0.75 mm²      | TPR HAL. FREE        | Black        | 6.5±0.2         | BN, BU, GN/YE     |
| 1210180094         | T          | 3          | 3         | 0.75 mm²      | PUR CSA/UL 20668     | Yellow       | 6.5±0.2         | BN, BU, GN/YE     |
| 1210180309         | Y          | 3          | 3         | 0.75 mm²      | SILICONE RUBBER      | Red          | 6.5±0.2         | BN, BU, GN/YE     |
| 1210180081         | F          | 4          | 3         | 1 mm²         | PVC CNOMO            | Grey         | 7.1+0.2/-0      | BK1, BK2, GN/YE   |
| 1210180042         | I          | 4          | 2         | 1 mm²         | PVC CEI 2022 II O.R. | Grey         | 7.1+0.2/-0      | BN, BU            |
| 1210180079         | I          | 4          | 3         | 1 mm²         | PVC CEI 2022 II O.R. | Grey         | 7.1+0.2/-0      | BN, BU, GN/YE     |
| 1210180036         | N          | 4          | 2         | 1 mm²         | PVC H05VV-F          | Black        | 6.5±0.2         | BN, BU            |
| 1210180082         | N          | 4          | 3         | 1 mm²         | PVC H05VV-F          | Black        | 6.9±0.2         | BN, BU, GN/YE     |
| 1210180117         | R          | 4          | 3         | 1 mm²         | TPR HAL. FREE        | Black        | 7.1±0.2         | BN, BU, GN/YE     |
| 1210180085         | N          | 5          | 3         | 1.5 mm²       | PVC H05VV-F          | Black        | 7.9±0.2         | BN, BU, GN/YE     |
| 1210180313         | I          | 6          | 2         | 0.35 mm²      | PVC CEI 2011         | Grey         | 4.8±0.2         | BN, WH            |
| 1210180149         | I          | 9          | 4         | 0.75 mm²      | PVC CEI 2022 II      | Grey         | 7.3±0.2         | BN, BU, BK, GN/YE |

TABLE 1 - CABLES TYPE

| Code | Cable types | Features  | Cable type Cross section              |
|------|-------------|---|---------------------------------------|
| N    | PVC         | Application general purpose cable which has good resistance to water, but usually poor oil resistance.                          | N2=0.5 mm2<br>N3=0.75 mm2<br>N4=1 mm2 |
| I    | CEI         | Approved to IEC 332-2A, flame retardant and self extinguishing. Limited resistant to mineral oils.                              | I2=0.5 mm2<br>I3=0.75 mm2<br>I4=1 mm2 |
| P    | PUR         | Offer good resistance to oil and chemicals. Can swell when constantly immersed in water.  | P2=0.5 mm2<br>P3=0.75 mm2<br>P4=1 mm2 |
| A    | PVC CSA-UL  | Approved to CSA-UL 2661, application general purpose cable which has good resistance to water, but usually poor oil resistance. | A2=20 AWG<br>A3=18 AWG                |
| B    | PUR CSA-UL  | Approved to CSA-UL 20668, very good resistance to oil and chemicals.  | B2=20 AWG<br>B3=18 AWG                |

|   |  |       |  |   |  |                        |  |   |  |
|---|--|-------|--|---|--|------------------------|--|---|--|
| THIS DRAWING CONTAINS INFORMATION THAT IS PROPRIETARY TO MOLEX ELECTRONIC TECHNOLOGIES, LLC AND SHOULD NOT BE USED WITHOUT WRITTEN PERMISSION |  |       |  |   |  |                        |  |   |  |
| DIMENSION UNITS   |  | SCALE |  | CURRENT REV DESC: REVISION CREATED FOR REMOVING PRE-RELEASE STAMP |  |                        |  |  |  |
| mm  |  | NTS   |  |   |  |                        |  |   |  |
| GENERAL TOLERANCES (UNLESS SPECIFIED)   |  |       |  | EC NO: 714567   |  | 2022/07/18             |  | E452XXXXXXXXXX  |  |
|   |  |       |  | DRWN: SUGEEB  |  | 2022/07/19             |  | DIN FORM A EN 175301-803  |  |
|   |  |       |  | CHK'D: GGA  |  | 2022/07/19             |  | PRODUCT CUSTOMER DRAWING  |  |
|   |  |       |  | APPR: GGA   |  | 2022/07/19             |  | DOCUMENT NUMBER   |  |
|   |  |       |  | INITIAL REVISION:   |  |                        |  | SD-121050-001   |  |
|   |  |       |  | DRWN: JMARSZALEK  |  | 2012/08/27             |  | DOC TYPE  |  |
|   |  |       |  | APPR: MDYSZEWSKA  |  | 2012/08/20             |  | PSD   |  |
|   |  |       |  | ANGULAR TOL   |  | °                      |  | DOC PART  |  |
|   |  |       |  | DRAFT WHERE APPLICABLE MUST REMAIN WITHIN DIMENSIONS              |  | FIRST ANGLE PROJECTION |  | 001   |  |
|   |  |       |  |   |  | DRAWING                |  | REVISION  |  |
|   |  |       |  |   |  | SERIES                 |  | E1  |  |
|   |  |       |  |   |  | MATERIAL NUMBER        |  | SHEET NUMBER  |  |
|   |  |       |  |   |  | A3-SIZE                |  | 3 OF 41   |  |
|   |  |       |  |   |  | 121050                 |  | GENERAL MARKET  |  |
|   |  |       |  |   |  | SEE TABLE              |  |   |  |

TABLE 3 - PART LIST

| Pos. | Molex PN:  | Engineering No.: |
|------|------------|------------------|
| 1    | 1210400514 | E452N3N10012000  |
| 2    | 1210400515 | E452N3N30012000  |
| 3    | 1210400516 | E452N3N50012000  |
| 4    | 1210400517 | E452P3N10012000  |
| 5    | 1210400519 | E452P3N30012000  |
| 6    | 1210400755 | E452N3N2001P000  |
| 7    | 1210400810 | E452N3N15K12000  |
| 8    | 1210400861 | E452N3N10011000  |
| 9    | 1210400896 | E452A2A80012000  |
| 10   | 1210400897 | E452A2A90012000  |
| 11   | 1210400898 | E452A2A70012000  |
| 12   | 1210400899 | E452A2A40012000  |
| 13   | 1210400900 | E452A2A50012000  |
| 14   | 1210400901 | E452N3N13K12000  |
| 15   | 1210400909 | E452A2A60012000  |
| 16   | 1210400957 | E452N3N20012000  |
| 17   | 1210401237 | W452P3N30012000  |
| 18   | 1210401242 | W452N3N50012000  |
| 19   | 1210401265 | W452N3N30012000  |
| 20   | 1210401291 | W452N3N10012000  |
| 21   | 1210500294 | E452A2A20011C4H  |
| 22   | 1210500295 | E452A3A10011C42  |
| 23   | 1210500297 | E452A3A30011C44  |
| 24   | 1210500298 | E452A3A30011C4H  |
| 25   | 1210500299 | E452A3A30012000  |
| 26   | 1210500301 | E452A3A30012C4H  |
| 27   | 1210500302 | E452A3A50012C4L  |
| 28   | 1210500311 | E452B3A30012C4H  |
| 29   | 1210500312 | E452B3A30012C4L  |
| 30   | 1210500313 | E452B3A50012C4H  |
| 31   | 1210500314 | E452B8N10012000  |
| 32   | 1210500339 | E452F4N10K11S3B  |
| 33   | 1210500344 | E452F4N20011S3B  |
| 34   | 1210500352 | E452F4N50011S3B  |
| 35   | 1210500362 | E452I0N20011C42  |
| 36   | 1210500375 | E452I2N10011C4H  |
| 37   | 1210500376 | E452I2N10011C72  |
| 38   | 1210500384 | E452I2N20011C3H  |
| 39   | 1210500385 | E452I2N20011C4H  |
| 40   | 1210500388 | E452I2N30011C32  |

| Pos. | Molex PN:  | Engineering No.: |
|------|------------|------------------|
| 41   | 1210500389 | E452I2N30011C3H  |
| 42   | 1210500390 | E452I2N30011C42  |
| 43   | 1210500392 | E452I2N30011C4H  |
| 44   | 1210500393 | E452I2N30011C4L  |
| 45   | 1210500394 | E452I2N30011C4M  |
| 46   | 1210500398 | E452I2N50011C42  |
| 47   | 1210500399 | E452I2N50011C4H  |
| 48   | 1210500407 | E452I4G30011C4B  |
| 49   | 1210500408 | E452I4G30011C4H  |
| 50   | 1210500414 | E452I4G40011C4H  |
| 51   | 1210500417 | E452I4G50011C4H  |
| 52   | 1210500424 | E452I4N10011C42  |
| 53   | 1210500428 | E452I4N10011C4H  |
| 54   | 1210500434 | E452I4N10K11C4H  |
| 55   | 1210500435 | E452I4N10K11C4L  |
| 56   | 1210500443 | E452I4N15K11C4H  |
| 57   | 1210500448 | E452I4N20011C3H  |
| 58   | 1210500452 | E452I4N20011C4H  |
| 59   | 1210500455 | E452I4N20011C7H  |
| 60   | 1210500465 | E452I4N30011A1H  |
| 61   | 1210500467 | E452I4N30011C3H  |
| 62   | 1210500468 | E452I4N30011C42  |
| 63   | 1210500469 | E452I4N30011C44  |
| 64   | 1210500473 | E452I4N30011C4H  |
| 65   | 1210500474 | E452I4N30011C4L  |
| 66   | 1210500475 | E452I4N30011C4M  |
| 67   | 1210500478 | E452I4N30011R2H  |
| 68   | 1210500479 | E452I4N30011R2L  |
| 69   | 1210500480 | E452I4N30011R2M  |
| 70   | 1210500481 | E452I4N30011S0H  |
| 71   | 1210500486 | E452I4N35011C45  |
| 72   | 1210500489 | E452I4N40011C42  |
| 73   | 1210500492 | E452I4N40011C4H  |
| 74   | 1210500498 | E452I4N50011C3H  |
| 75   | 1210500499 | E452I4N50011C42  |
| 76   | 1210500504 | E452I4N50011C4H  |
| 77   | 1210500505 | E452I4N50011C4L  |
| 78   | 1210500506 | E452I4N50011C4M  |
| 79   | 1210500510 | E452I4N50011R2L  |
| 80   | 1210500511 | E452I4N50011S0H  |

| Pos. | Molex PN:  | Engineering No.: |
|------|------------|------------------|
| 81   | 1210500514 | E452I4N55011C72  |
| 82   | 1210500515 | E452I4N60011C42  |
| 83   | 1210500520 | E452I4N70011R2H  |
| 84   | 1210500522 | E452I4N80011C4H  |
| 85   | 1210500524 | E452I8N50011C4H  |
| 86   | 1210500548 | E452N3N10011A11  |
| 87   | 1210500549 | E452N3N10011C42  |
| 88   | 1210500551 | E452N3N10011C45  |
| 89   | 1210500552 | E452N3N10011C4B  |
| 90   | 1210500554 | E452N3N10011C4H  |
| 91   | 1210500556 | E452N3N10011R2H  |
| 92   | 1210500558 | E452N3N10012C4H  |
| 93   | 1210500559 | E452N3N10012C4L  |
| 94   | 1210500560 | E452N3N10022C4L  |
| 95   | 1210500562 | E452N3N10K11C42  |
| 96   | 1210500569 | E452N3N10K11S02  |
| 97   | 1210500572 | E452N3N10K11S0H  |
| 98   | 1210500575 | E452N3N10K12C4H  |
| 99   | 1210500576 | E452N3N10K12C4L  |
| 100  | 1210500582 | E452N3N15011A11  |
| 101  | 1210500583 | E452N3N15011A12  |
| 102  | 1210500584 | E452N3N15011A15  |
| 103  | 1210500585 | E452N3N15011C32  |
| 104  | 1210500591 | E452N3N15012C4H  |
| 105  | 1210500594 | E452N3N15022C4L  |
| 106  | 1210500599 | E452N3N15K12C4H  |
| 107  | 1210500601 | E452N3N20011A11  |
| 108  | 1210500602 | E452N3N20011A12  |
| 109  | 1210500603 | E452N3N20011A14  |
| 110  | 1210500606 | E452N3N20011A1H  |
| 111  | 1210500612 | E452N3N20011C42  |
| 112  | 1210500620 | E452N3N20011C4H  |
| 113  | 1210500621 | E452N3N20011C4L  |
| 114  | 1210500624 | E452N3N20011R05  |
| 115  | 1210500627 | E452N3N20011R2M  |
| 116  | 1210500636 | E452N3N25011C42  |
| 117  | 1210500638 | E452N3N25011C4H  |
| 118  | 1210500644 | E452N3N30011A1H  |
| 119  | 1210500648 | E452N3N30011C32  |
| 120  | 1210500649 | E452N3N30011C41  |

| Pos. | Molex PN:  | Engineering No.: |
|------|------------|------------------|
| 121  | 1210500650 | E452N3N30011C42  |
| 122  | 1210500651 | E452N3N30011C44  |
| 123  | 1210500652 | E452N3N30011C45  |
| 124  | 1210500657 | E452N3N30011C4H  |
| 125  | 1210500658 | E452N3N30011C4L  |
| 126  | 1210500659 | E452N3N30011C4M  |
| 127  | 1210500662 | E452N3N30011R2H  |
| 128  | 1210500666 | E452N3N30011S0D  |
| 129  | 1210500673 | E452N3N30012C4H  |
| 130  | 1210500674 | E452N3N30012C4L  |
| 131  | 1210500685 | E452N3N35011A11  |
| 132  | 1210500689 | E452N3N40011A12  |
| 133  | 1210500690 | E452N3N40011C42  |
| 134  | 1210500691 | E452N3N40011C44  |
| 135  | 1210500692 | E452N3N40011C45  |
| 136  | 1210500693 | E452N3N40011C4H  |
| 137  | 1210500696 | E452N3N50011A1B  |
| 138  | 1210500702 | E452N3N50011C42  |
| 139  | 1210500703 | E452N3N50011C44  |
| 140  | 1210500705 | E452N3N50011C4B  |
| 141  | 1210500707 | E452N3N50011C4D  |
| 142  | 1210500708 | E452N3N50011C4E  |
| 143  | 1210500709 | E452N3N50011C4H  |
| 144  | 1210500711 | E452N3N50011S02  |
| 145  | 1210500712 | E452N3N50011S0D  |
| 146  | 1210500713 | E452N3N50011S0H  |
| 147  | 1210500714 | E452N3N50012C44  |
| 148  | 1210500715 | E452N3N50012C4H  |
| 149  | 1210500716 | E452N3N50012C4L  |
| 150  | 1210500722 | E452N3N65021C42  |
| 151  | 1210500730 | E452P2N04011C4H  |
| 152  | 1210500735 | E452P2N07511C32  |
| 153  | 1210500737 | E452P2N10011C4H  |
| 154  | 1210500739 | E452P2N10K11C4H  |
| 155  | 1210500741 | E452P2N10K11S0H  |
| 156  | 1210500742 | E452P2N11011C4H  |
| 157  | 1210500747 | E452P2N16011C4H  |
| 158  | 1210500748 | E452P2N20011C4H  |
| 159  | 1210500755 | E452P2N30011C4L  |
| 160  | 1210500759 | E452P2N30011S0H  |

|   |  |       |  |   |  |            |  |   |  |
|---|--|-------|--|---|--|------------|--|---|--|
| THIS DRAWING CONTAINS INFORMATION THAT IS PROPRIETARY TO MOLEX ELECTRONIC TECHNOLOGIES, LLC AND SHOULD NOT BE USED WITHOUT WRITTEN PERMISSION |  |       |  |   |  |            |  |   |  |
| DIMENSION UNITS   |  | SCALE |  | CURRENT REV DESC: REVISION CREATED FOR REMOVING PRE-RELEASE STAMP                     |  |            |  | <br>E452XXXXXXXXXX<br>DIN FORM A EN 175301-803 |  |
| mm  |  | NTS   |  |   |  |            |  |   |  |
| GENERAL TOLERANCES (UNLESS SPECIFIED)   |  |       |  | EC NO: 714567   |  | 2022/07/18 |  | PRODUCT CUSTOMER DRAWING  |  |
|   |  |       |  | DRWN: SUGEEB  |  | 2022/07/19 |  |   |  |
|   |  |       |  | CHK'D: GGA  |  | 2022/07/19 |  |   |  |
|   |  |       |  | APPR: GGA   |  | 2022/07/19 |  |   |  |
|   |  |       |  | INITIAL REVISION:   |  |            |  |   |  |
|   |  |       |  | DRWN: JMARSZALEK  |  | 2012/08/27 |  | DOCUMENT NUMBER   |  |
|   |  |       |  | APPR: MDYSZEWSKA  |  | 2012/08/20 |  | SD-121050-001   |  |
|   |  |       |  | ANGULAR TOL   |  |            |  | DOC TYPE  |  |
|   |  |       |  |   |  |            |  | PSD   |  |
|   |  |       |  |   |  |            |  | DOC PART  |  |
|   |  |       |  |   |  |            |  | 001   |  |
|   |  |       |  |   |  |            |  | REVISION  |  |
|   |  |       |  |   |  |            |  | E1  |  |
| DRAFT WHERE APPLICABLE MUST REMAIN WITHIN DIMENSIONS  |  |       |  | FIRST ANGLE PROJECTION  |  | DRAWING    |  | SERIES  |  |
|   |  |       |  |  |  | A3-SIZE    |  | 121050  |  |
|   |  |       |  |   |  |            |  | MATERIAL NUMBER   |  |
|   |  |       |  |   |  |            |  | SEE TABLE   |  |
|   |  |       |  |   |  |            |  | CUSTOMER  |  |
|   |  |       |  |   |  |            |  | GENERAL MARKET  |  |
|   |  |       |  |   |  |            |  | SHEET NUMBER  |  |
|   |  |       |  |   |  |            |  | 4 OF 41   |  |

TABLE 3 - PART LIST

| Pos. | Molex PN:  | Engineering No.: |
|------|------------|------------------|
| 161  | 1210500764 | E452P2N50011C42  |
| 162  | 1210500766 | E452P2N50011C4B  |
| 163  | 1210500769 | E452P2N50011C4H  |
| 164  | 1210500770 | E452P2N50011C4L  |
| 165  | 1210500776 | E452P2N50011S0H  |
| 166  | 1210500787 | E452P3N05011S0B  |
| 167  | 1210500791 | E452P3N10012C4H  |
| 168  | 1210500792 | E452P3N10012C4L  |
| 169  | 1210500795 | E452P3N10K11S0H  |
| 170  | 1210500801 | E452P3N15011S0H  |
| 171  | 1210500803 | E452P3N20011C42  |
| 172  | 1210500807 | E452P3N30011C3H  |
| 173  | 1210500810 | E452P3N30011C4H  |
| 174  | 1210500812 | E452P3N30011S0B  |
| 175  | 1210500814 | E452P3N30011S0H  |
| 176  | 1210500815 | E452P3N30012C4H  |
| 177  | 1210500816 | E452P3N30012C4L  |
| 178  | 1210500817 | E452P3N50011C3H  |
| 179  | 1210500819 | E452P3N50011C4H  |
| 180  | 1210500821 | E452P3N50011S02  |
| 181  | 1210500822 | E452P3N50011S0B  |
| 182  | 1210500823 | E452P3N50011S0H  |
| 183  | 1210500824 | E452P3N50012000  |
| 184  | 1210500826 | E452P3N50012C4H  |
| 185  | 1210500827 | E452P3N50012C4L  |
| 186  | 1210501560 | E452A2A10012000  |
| 187  | 1210501561 | E452N3N50011C4M  |
| 188  | 1210501563 | E452A2A30012000  |
| 189  | 1210501569 | E452I2N15011C7H  |
| 190  | 1210501577 | E452N3N50011C4L  |
| 191  | 1210501578 | E452B3A50012C4L  |
| 192  | 1210501581 | E452P3N07011C4H  |
| 193  | 1210501584 | E452I4G60011C4H  |
| 194  | 1210501587 | E452P3N50011R2E  |
| 195  | 1210501591 | E452A3A50012C4H  |
| 196  | 1210501607 | E452N3N10013C4H  |
| 197  | 1210501608 | E452N3N50013C4H  |
| 198  | 1210501609 | E452N2N15011E05  |
| 199  | 1210501610 | E452P2N30011C4H  |
| 200  | 1210501611 | E452A3A10K12C4H  |

| Pos. | Molex PN:  | Engineering No.: |
|------|------------|------------------|
| 201  | 1210501612 | E452I4G20011C4H  |
| 202  | 1210501624 | E452A3A30012C4L  |
| 203  | 1210501632 | E452P2N20011C42  |
| 204  | 1210501647 | E452P3N20011S02  |
| 205  | 1210501656 | E452A2A50012C4H  |
| 206  | 1210501657 | E452P3N20011C44  |
| 207  | 1210501664 | E452P3N10011C4H  |
| 208  | 1210501674 | E452A3A20011C44  |
| 209  | 1210501690 | E452N2N50011C4H  |
| 210  | 1210501698 | E452I4N20011C3B  |
| 211  | 1210501720 | E452I4N80011C72  |
| 212  | 1210501726 | E452A3A20011C45  |
| 213  | 1210501733 | E452P3N50011A1H  |
| 214  | 1210501735 | E452N2N30011A12  |
| 215  | 1210501737 | E452N2N10011R2H  |
| 216  | 1210501749 | E452A2A15011C4H  |
| 217  | 1210501764 | E452N3N06011A12  |
| 218  | 1210501766 | E452N3N10011A12  |
| 219  | 1210501780 | E452A3A30011R2L  |
| 220  | 1210501781 | E452B3A30011C4H  |
| 221  | 1210501795 | E452I2N10K11C4H  |
| 222  | 1210501799 | E452N2N30011A1M  |
| 223  | 1210501800 | E452N2N30011A1D  |
| 224  | 1210501801 | E452A3A50012000  |
| 225  | 1210501813 | E452I4N60011C4H  |
| 226  | 1210501840 | E452A2A30011C32  |
| 227  | 1210501844 | E452I4N15011C4H  |
| 228  | 1210501867 | E452N3N10011C4M  |
| 229  | 1210501874 | E452A3A20011A1M  |
| 230  | 1210501878 | E452N3N1001PC4H  |
| 231  | 1210501879 | E452A3A30011C4L  |
| 232  | 1210501882 | E452B3A30022000  |
| 233  | 1210501887 | E452A3A50011C7H  |
| 234  | 1210501888 | E452A3A20011C7H  |
| 235  | 1210501889 | E452P3N3001PS0H  |
| 236  | 1210501890 | E452P3N5001PS0H  |
| 237  | 1210501891 | E452P3N5001PC4M  |
| 238  | 1210501892 | E452B3A10012000  |
| 239  | 1210501916 | E452I2N50011C44  |
| 240  | 1210501921 | E452N2N20091C3H  |

| Pos. | Molex PN:  | Engineering No.: |
|------|------------|------------------|
| 241  | 1210501932 | E452I4G40011S0H  |
| 242  | 1210501941 | E452N3N3001PS0H  |
| 243  | 1210501942 | E452N3N1001PS0H  |
| 244  | 1210501960 | E452I4N70011R2L  |
| 245  | 1210501962 | E452P3N3001PC4H  |
| 246  | 1210501966 | E452A3A50012C3H  |
| 247  | 1210501968 | E452N3N2001PC42  |
| 248  | 1210501973 | E452I4N50011C3B  |
| 249  | 1210501998 | E452P3N1001PC4H  |
| 250  | 1210501999 | E452P3N3001PC45  |
| 251  | 1210502000 | E452I4N50011S02  |
| 252  | 1210502004 | E452A3A50011S0H  |
| 253  | 1210502007 | E452A2A15011S0H  |
| 254  | 1210502008 | E452A2A50011S0H  |
| 255  | 1210502018 | E452N3N25011S0H  |
| 256  | 1210502022 | E452A3A10K12000  |
| 257  | 1210502024 | E452A3A50011C44  |
| 258  | 1210502034 | E452N2N30011A14  |
| 259  | 1210502035 | E452A3A10012C4L  |
| 260  | 1210502038 | E452N3N5001PC4H  |
| 261  | 1210502039 | E452N3N3001PC4H  |
| 262  | 1210502043 | E452A2A20011S0H  |
| 263  | 1210502044 | E452A2A30011S0H  |
| 264  | 1210502050 | E452N3N10K11C4L  |
| 265  | 1210502052 | E452P3N2001PC3H  |
| 266  | 1210502068 | E452T3A30011C4H  |
| 267  | 1210502072 | E452P3N1501PS0H  |
| 268  | 1210502077 | E452I2N40011C42  |
| 269  | 1210502080 | E452I4N60011C32  |
| 270  | 1210502083 | E452N2N30011A1H  |
| 271  | 1210502084 | E452N2N30011C3H  |
| 272  | 1210502091 | E452T3A20011C4H  |
| 273  | 1210502100 | E452N3N20011C41  |
| 274  | 1210502115 | E452T3A10011C4H  |
| 275  | 1210502128 | E452I4N35011A1B  |
| 276  | 1210502134 | E452N3N10011C3G  |
| 277  | 1210502137 | E452N3N5001RA1H  |
| 278  | 1210502142 | E452N3N3001RC4H  |
| 279  | 1210502171 | E452A2A10011S0H  |
| 280  | 1210502177 | E452N2N30011C42  |

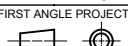
| Pos. | Molex PN:  | Engineering No.: |
|------|------------|------------------|
| 281  | 1210502178 | E452N2N30011C44  |
| 282  | 1210502180 | E452I4N10K11C3H  |
| 283  | 1210502190 | E452I2N10014A1G  |
| 284  | 1210502194 | E452F4N5001RC4E  |
| 285  | 1210502213 | E452N2N30011R2M  |
| 286  | 1210502214 | E452N2N15041C4H  |
| 287  | 1210502219 | E452I4N50011R2M  |
| 288  | 1210502223 | E452P3N5001PC4H  |
| 289  | 1210502232 | E452N2N30041C4H  |
| 290  | 1210502233 | E452N3N5001PS0H  |
| 291  | 1210502244 | E452N3N20011R2H  |
| 292  | 1210502247 | E452N2N5001RA1H  |
| 293  | 1210502248 | E452N2N10K1RA1H  |
| 294  | 1210502256 | E452T3A06011C4H  |
| 295  | 1210502258 | E452A3A30012C4M  |
| 296  | 1210502259 | E452A3A20011C42  |
| 297  | 1210502262 | E452N3N40011R2M  |
| 298  | 1210502278 | E452N3N1001TR2H  |
| 299  | 1210502281 | E452N2N30011C4M  |
| 300  | 1210502283 | E452T3A60011C4H  |
| 301  | 1210502289 | E452I4N5001PC4H  |
| 302  | 1210502309 | E452N3N4001PC4H  |
| 303  | 1210502311 | E452A3A10K11S0H  |
| 304  | 1210502314 | E452N3N2001PR2M  |
| 305  | 1210502317 | E452N2N10011A12  |
| 306  | 1210502318 | E452N3N2001PC3H  |
| 307  | 1210502328 | E452B2A30011A15  |
| 308  | 1210502334 | E452A3A30011C42  |
| 309  | 1210502335 | E452P3N2001PC4H  |
| 310  | 1210502341 | E452N3N10K11C4H  |
| 311  | 1210502346 | E452N2N10K12C4H  |
| 312  | 1210502352 | E452N3N50012S02  |
| 313  | 1210502353 | E452A3A30022000  |
| 314  | 1210502357 | E452B3A50011C4H  |
| 315  | 1210502359 | E452I2N50011C3H  |
| 316  | 1210502363 | E452A2A10K11S0H  |
| 317  | 1210502375 | E452N2N10011R24  |
| 318  | 1210502389 | E452N3N55021A12  |
| 319  | 1210502396 | E452P3N10K11C4H  |
| 320  | 1210502404 | E452P2N20011S0B  |

|   |  |       |  |   |  |            |  |   |  |
|---|--|-------|--|---|--|------------|--|---|--|
| THIS DRAWING CONTAINS INFORMATION THAT IS PROPRIETARY TO MOLEX ELECTRONIC TECHNOLOGIES, LLC AND SHOULD NOT BE USED WITHOUT WRITTEN PERMISSION |  |       |  |   |  |            |  |   |  |
| DIMENSION UNITS   |  | SCALE |  | CURRENT REV DESC: REVISION CREATED FOR REMOVING PRE-RELEASE STAMP                     |  |            |  | <br>E452XXXXXXXXXX<br>DIN FORM A EN 175301-803 |  |
| mm  |  | NTS   |  |   |  |            |  |   |  |
| GENERAL TOLERANCES (UNLESS SPECIFIED)   |  |       |  |   |  |            |  |   |  |
|   |  | MM    |  | INCH  |  |            |  |   |  |
| 4 PLACES  |  | ±     |  | ±   |  |            |  |   |  |
| 3 PLACES  |  | ±     |  | ±   |  |            |  |   |  |
| 2 PLACES  |  | ±     |  | ±   |  |            |  |   |  |
| 1 PLACE   |  | ±     |  | ±   |  |            |  |   |  |
| 0 PLACES  |  | ±     |  | ±   |  |            |  |   |  |
| ANGULAR TOL   |  | ± °   |  | ± °   |  |            |  |   |  |
| DRAFT WHERE APPLICABLE MUST REMAIN WITHIN DIMENSIONS  |  |       |  | FIRST ANGLE PROJECTION  |  | DRAWING    |  | SERIES  |  |
|   |  |       |  |  |  | A3-SIZE    |  | 121050  |  |
| DOCUMENT STATUS   |  | P1    |  | RELEASE DATE  |  | 2022/07/19 |  | 09:04:35  |  |
|   |  | 9     |  | 8   |  | 7          |  | 6   |  |
|   |  | 5     |  | 4   |  | 3          |  | 2   |  |
|   |  | 1     |  |   |  |            |  |   |  |



TABLE 3 - PART LIST

| Pos. | Molex PN:  | Engineering No.: |
|------|------------|------------------|
| 321  | 1210502411 | E452P3N10011R2E  |
| 322  | 1210502413 | E452P2N50011C4M  |
| 323  | 1210502414 | E452A3A50021000  |
| 324  | 1210502416 | E452N2N20011C4H  |
| 325  | 1210502417 | E452R4N2001PC4M  |
| 326  | 1210502418 | E452R4N2001PR2E  |
| 327  | 1210502419 | E452N3N8001RA1H  |
| 328  | 1210502438 | E452I4N70011A1L  |
| 329  | 1210502441 | E452I2N20011C7H  |
| 330  | 1210502447 | E452I4N15011R22  |
| 331  | 1210502471 | E452N2N20011C42  |
| 332  | 1210502474 | E452N3N15011C3A  |
| 333  | 1210502475 | E452N3N25011S0B  |
| 334  | 1210502476 | E452I4N90011C3H  |
| 335  | 1210502479 | E452Y3N40011C42  |
| 336  | 1210502488 | E452P3N30011C4M  |
| 337  | 1210502492 | E452Y3N20011A14  |
| 338  | 1210502495 | E452A3A30012C4G  |
| 339  | 1210502497 | E452N3N4001RA1G  |
| 340  | 1210502501 | E452B3A30012C3H  |
| 341  | 1210502505 | E452P2N15K11C4H  |
| 342  | 1210502507 | E452N3N20014S04  |
| 343  | 1210502510 | E452N3N1001RC4H  |
| 344  | 1210502518 | E452A3A50011R2L  |
| 345  | 1210502520 | E452N3N2001PS02  |
| 346  | 1210502522 | E452I4N60011C3H  |
| 347  | 1210502523 | E452P2N40011C3B  |
| 348  | 1210502524 | E452P2N20011C3B  |
| 349  | 1210502525 | E452Y3N20011A12  |
| 350  | 1210502526 | E452P3N0751PC4M  |
| 351  | 1210502527 | E452I4N15011A1H  |
| 352  | 1210502530 | E452I4G40011C42  |
| 353  | 1210502531 | E452I4G50011C42  |
| 354  | 1210502539 | E452N3N12011C4M  |
| 355  | 1210502540 | E452A2A11K12000  |
| 356  | 1210502543 | E452P2N50011C4G  |
| 357  | 1210502548 | E452I4G10K11C4H  |
| 358  | 1210502549 | E452I4G15K11C4H  |
| 359  | 1210502551 | E452N2N20011E05  |
| 360  | 1210502554 | E452N3N5001PS02  |

| Pos. | Molex PN:  | Engineering No.: |
|------|------------|------------------|
| 361  | 1210502555 | E452P3N40011C3H  |
| 362  | 1210502561 | E452N2N20011A11  |
| 363  | 1210502564 | E452N3N10K1RA1H  |
| 364  | 1210502565 | E452Y3N20011C42  |
| 365  | 1210502567 | E452Y3N40011A12  |
| 366  | 1210502568 | E452B2B10011A12  |
| 367  | 1210502572 | E452N3N05011C31  |
| 368  | 1210502575 | E452B2A1502TC32  |
| 369  | 1210502577 | E452N3N0501RC4B  |
| 370  | 1210502578 | E452N3N12K1RA1H  |
| 371  | 1210502579 | E452I4G80011C4H  |
| 372  | 1210502581 | E452N2N20011A1H  |
| 373  | 1210502584 | E452N3N03011A12  |
| 374  | 1210502585 | E452P3N5001PC4L  |
| 375  | 1210502586 | E452P3N10011C4L  |
| 376  | 1210502589 | E452N3N5001PC4M  |
| 377  | 1210502590 | E452I2N40011C4M  |
| 378  | 1210502596 | E452P3N20012C4H  |
| 379  | 1210502599 | E452P2N10K12C4B  |
| 380  | 1210502601 | E452A2A30021C4H  |
| 381  | 1210502605 | E452P3N15K1PC4H  |
| 382  | 1210502606 | E452N3N2001PA1H  |
| 383  | 1210502607 | E452D2N50011C4H  |
| 384  | 1210502609 | E452N2N30011C45  |
| 385  | 1210502616 | E452I2N60011C4M  |
| 386  | 1210502619 | E452B3A3001PA1H  |
| 387  | 1210502620 | E452B3A3001PA1L  |
| 388  | 1210502621 | E452B3A3001PA1M  |
| 389  | 1210502624 | E452P3N20011C4L  |
| 390  | 1210502627 | E452I2N60011C4H  |
| 391  | 1210502632 | E452I2N20011S12  |
| 392  | 1210502633 | E452Y3N50011C42  |
| 393  | 1210502634 | E452I4N3001PR2M  |
| 394  | 1210502635 | E452Y3N20011A15  |
| 395  | 1210502638 | E452N3N25041C42  |
| 396  | 1210502639 | E452A3A3001RC32  |
| 397  | 1210502640 | E452A3A10K1RC32  |
| 398  | 1210502641 | E452A3A3001RC44  |
| 399  | 1210502642 | E452A3A10K1RC34  |
| 400  | 1210502646 | E452I4G30011C4L  |

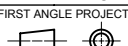
| Pos. | Molex PN:  | Engineering No.: |
|------|------------|------------------|
| 401  | 1210502647 | E452A2A30011C4H  |
| 402  | 1210502648 | E452N3N10011C41  |
| 403  | 1210502650 | E452A3A10K1RS0H  |
| 404  | 1210502654 | E452P1N50011C45  |
| 405  | 1210502659 | E452N3N40011R2H  |
| 406  | 1210502660 | E452N2N30011A11  |
| 407  | 1210502662 | E452P3N10K1PC4H  |
| 408  | 1210502664 | E452N3N3001PC42  |
| 409  | 1210502666 | E452B3B50011C4H  |
| 410  | 1210502671 | E452I2N15011C3H  |
| 411  | 1210502672 | E452I2N40011C3H  |
| 412  | 1210502676 | E452I2N20012S12  |
| 413  | 1210502678 | E452A3A3001RC42  |
| 414  | 1210502679 | E452P3N50011C4M  |
| 415  | 1210502680 | E452N3N03011C42  |
| 416  | 1210502681 | E452N3N50011C3H  |
| 417  | 1210502682 | E452P2N03011C4H  |
| 418  | 1210502683 | E452P2N05011C4H  |
| 419  | 1210502686 | E452N2N15011C4B  |
| 420  | 1210502687 | E452N3N10K1RC4H  |
| 421  | 1210502690 | E452N3N0501NC31  |
| 422  | 1210502706 | W452N2N5001RC4B  |
| 423  | 1210502712 | W452I2N50011S0H  |
| 424  | 1210502715 | W452I2N10K11S0H  |
| 425  | 1210502750 | W452N3N3001RR2B  |
| 426  | 1210502751 | W452N4N2001RS01  |
| 427  | 1210502752 | W452N3N2001R000  |
| 428  | 1210502753 | W452N3N15K1RC4B  |
| 429  | 1210502755 | W452N3N30011C45  |
| 430  | 1210502758 | W452I4N20011C7H  |
| 431  | 1210502762 | W452I4N20011C4L  |
| 432  | 1210502764 | W452I4N20011C4M  |
| 433  | 1210502821 | W452I4N50011C7H  |
| 434  | 1210502859 | W452N3N10K1RC4B  |
| 435  | 1210502860 | W452F4N10K1RS0B  |
| 436  | 1210502861 | W452A3A10K1RS0H  |
| 437  | 1210502862 | W452N3N3001RC4D  |
| 438  | 1210502863 | W452N3N3001RC4B  |
| 439  | 1210502864 | W452N3N2001RR05  |
| 440  | 1210502865 | W452N3N2001RC4B  |

| Pos. | Molex PN:  | Engineering No.: |
|------|------------|------------------|
| 441  | 1210502866 | W452N3N2001RC4A  |
| 442  | 1210502867 | W452A3A5001RS0H  |
| 443  | 1210502868 | W452N3N5001RS0D  |
| 444  | 1210502869 | W452N3N5001RC4E  |
| 445  | 1210502870 | W452N3N5001RC4D  |
| 446  | 1210502871 | W452N3N5001RC4B  |
| 447  | 1210502872 | W452N3N3001RC4E  |
| 448  | 1210502874 | W452N3N2001RC4H  |
| 449  | 1210502875 | W452N3N2001RA1E  |
| 450  | 1210502876 | W452P3N5001RC42  |
| 451  | 1210502877 | W452N3N2001RC3A  |
| 452  | 1210502878 | W452N3N3001RC4C  |
| 453  | 1210502890 | W452N3N5001RA1B  |
| 454  | 1210502892 | W452N3N2001RC4E  |
| 455  | 1210502893 | W452N3N5001RC3B  |
| 456  | 1210502894 | W452P3N5001RC4B  |
| 457  | 1210502908 | W452N3N5001RC4C  |
| 458  | 1210502909 | W452N3N10K1RC4E  |
| 459  | 1210502910 | W452N3N10K1RC4C  |
| 460  | 1210502911 | W452F4N5001RC4B  |
| 461  | 1210502914 | W452N3N3001RR2M  |
| 462  | 1210502915 | W452N3N5001RC4A  |
| 463  | 1210502916 | E452N3N0501RC4A  |
| 464  | 1210502922 | W452I2N50011C7H  |
| 465  | 1210502923 | W452I2N20011C7H  |
| 466  | 1210502924 | W452I4N3006PC3B  |
| 467  | 1210502925 | W452I4N15K6PC3B  |
| 468  | 1210502934 | W452N3N5001RC4H  |
| 469  | 1210502942 | W452I2N10K6PC3B  |
| 470  | 1210502953 | W452I2N5006PC3B  |
| 471  | 1210502955 | W452N3N10K1RC4D  |
| 472  | 1210502956 | W452N3N30011C44  |
| 473  | 1210502958 | W452N3N2001RC3B  |
| 474  | 1210502968 | W452P3N10K1RS0H  |
| 475  | 1210502970 | W452F4N3001RC4B  |
| 476  | 1210502973 | E452I4G30011C42  |
| 477  | 1210502974 | W452P3N3001RA1G  |
| 478  | 1210502976 | E452N3N10011C4L  |
| 479  | 1210502977 | E452N3N30011A11  |
| 480  | 1210502982 | E452A3A10012C4H  |

|   |  |             |  |   |  |            |  |   |  |
|---|--|-------------|--|---|--|------------|--|---|--|
| THIS DRAWING CONTAINS INFORMATION THAT IS PROPRIETARY TO MOLEX ELECTRONIC TECHNOLOGIES, LLC AND SHOULD NOT BE USED WITHOUT WRITTEN PERMISSION |  |             |  |   |  |            |  |   |  |
| DIMENSION UNITS   |  | SCALE       |  | CURRENT REV DESC: REVISION CREATED FOR REMOVING PRE-RELEASE STAMP                     |  |            |  | <br>E452XXXXXXXXXX<br>DIN FORM A EN 175301-803 |  |
| mm  |  | NTS         |  |   |  |            |  |   |  |
| GENERAL TOLERANCES (UNLESS SPECIFIED)   |  |             |  |   |  |            |  |   |  |
|   |  | MM          |  | INCH  |  |            |  |   |  |
| 4 PLACES  |  | ±           |  | ±   |  |            |  |   |  |
| 3 PLACES  |  | ±           |  | ±   |  |            |  |   |  |
| 2 PLACES  |  | ±           |  | ±   |  |            |  |   |  |
| 1 PLACE   |  | ±           |  | ±   |  |            |  |   |  |
| 0 PLACES  |  | ±           |  | ±   |  |            |  |   |  |
| ANGULAR TOL   |  | ± °         |  |   |  |            |  |   |  |
| DRAFT WHERE APPLICABLE MUST REMAIN WITHIN DIMENSIONS  |  |             |  | FIRST ANGLE PROJECTION  |  | DRAWING    |  | SERIES  |  |
|   |  |             |  |  |  | A3-SIZE    |  | 121050  |  |
| DOCUMENT STATUS   |  | P1          |  | RELEASE DATE  |  | 2022/07/19 |  | 09:04:35  |  |
| FORMAT: Mol-lega-master-ib-prod-A3  |  | REVISION: E |  | DATE: 2020/01/14  |  |            |  |   |  |

TABLE 3 - PART LIST

| Pos. | Molex PN:  | Engineering No.: |
|------|------------|------------------|
| 481  | 1210502984 | E452A3A10K11C7H  |
| 482  | 1210502985 | E452P1N15K11C45  |
| 483  | 1210502987 | E452R4N3001PR2E  |
| 484  | 1210502988 | E452N3N30022C4H  |
| 485  | 1210502989 | E452N3N30022C4M  |
| 486  | 1210502991 | E452N2N30011C31  |
| 487  | 1210502994 | E452N2N20061C42  |
| 488  | 1210502997 | E452N3N50041C42  |
| 489  | 1210503000 | E452P2N10011C3B  |
| 490  | 1210503001 | E452R4N3001PR2M  |
| 491  | 1210503005 | E452P3N12K11C4H  |
| 492  | 1210503007 | E452P3N10011R2B  |
| 493  | 1210503008 | E452N3N3001GC4M  |
| 494  | 1210503013 | E452I2N10011C42  |
| 495  | 1210503014 | E452N2N30021A12  |
| 496  | 1210503017 | E452I2N30021C3H  |
| 497  | 1210503018 | E452N3N30011R22  |
| 498  | 1210503020 | W452A3A15K1RS0H  |
| 499  | 1210503022 | E452A2A10K11S0L  |
| 500  | 1210503026 | E452N2N15011C42  |
| 501  | 1210503030 | E452N2N03011C4H  |
| 502  | 1210503032 | W452P3N2001RC4E  |
| 503  | 1210503039 | E452N3N55011D02  |
| 504  | 1210503041 | W452N3N5001RR2D  |
| 505  | 1210503042 | E452P3N5001PS0E  |
| 506  | 1210503046 | E452N3N2001NC31  |
| 507  | 1210503047 | E452B3A50063C4L  |
| 508  | 1210503048 | E452B3A50023C4L  |
| 509  | 1210503049 | E452A2A70011S0H  |
| 510  | 1210503050 | E452N3N30013C4G  |
| 511  | 1210503051 | E452N3N50013C4G  |
| 512  | 1210503053 | W452N3N2001RC4C  |
| 513  | 1210503056 | E452B3A10K1PR2D  |
| 514  | 1210503101 | E452N2N30011R2B  |
| 515  | 1210503102 | E452N3N3001RC41  |
| 516  | 1210503104 | E452A3A15011S0H  |
| 517  | 1210503105 | E452A3A30011S0H  |
| 518  | 1210503106 | E452A3A75011S0H  |
| 519  | 1210503112 | E452I0N30011C4H  |
| 520  | 1210503113 | E452N3N5001RC4B  |

| Pos. | Molex PN:  | Engineering No.: |
|------|------------|------------------|
| 521  | 1210503119 | E452I4N80011C7H  |
| 522  | 1210503120 | E452I4N3006PC3B  |
| 523  | 1210503123 | E452A3A15K1RS0H  |
| 524  | 1210503130 | W452N3N5001RR25  |
| 525  | 1210503131 | E452I2N5006PC3B  |
| 526  | 1210503132 | W452N3N3001RC41  |
| 527  | 1210503135 | E452N2N10011C4D  |
| 528  | 1210503138 | E452N3N5001RC41  |
| 529  | 1210503139 | E452N2N30011R05  |
| 530  | 1210503140 | E452B3A30011S0H  |
| 531  | 1210503142 | E452P3N50011C44  |
| 532  | 1210503191 | E452R4N3001PC4H  |
| 533  | 1210503192 | W452A3A10K1RC4M  |
| 534  | 1210503195 | E452P3N1501PA1H  |
| 535  | 1210503196 | W452N2N30041C4H  |
| 536  | 1210503200 | E452P2N20011A12  |
| 537  | 1210503202 | E452B3A10012C41  |
| 538  | 1210503203 | E452B3A10012C4A  |
| 539  | 1210503204 | E452N3N10K12C3H  |
| 540  | 1210503205 | E452N3N10K12A1H  |
| 541  | 1210503213 | W452N3N50012C4H  |
| 542  | 1210503214 | W452P3N10012C4H  |
| 543  | 1210503215 | W452N3N30012C4H  |
| 544  | 1210503216 | W452P3N30012C4H  |
| 545  | 1210503217 | W452P3N20012C4H  |
| 546  | 1210503219 | E452I4N30011A1G  |
| 547  | 1210503221 | W452I4N30011R2H  |
| 548  | 1210503222 | W452I4N30011R2L  |
| 549  | 1210503223 | W452I4N30011R2M  |
| 550  | 1210503229 | E452N2N25011C42  |
| 551  | 1210503231 | E452N3N1001PC4M  |
| 552  | 1210503233 | W452N3N30012C4L  |
| 553  | 1210503234 | W452P3N50012C4H  |
| 554  | 1210503237 | E452P3N5001PC3H  |
| 555  | 1210503238 | E452P3N3001PC3H  |
| 556  | 1210503242 | E452P3N10K1PC45  |
| 557  | 1210503243 | E452P3N5001PC45  |
| 558  | 1210503244 | E452P3N15K1PC45  |
| 559  | 1210503248 | E452B2A50011C4H  |
| 560  | 1210503256 | E452A3A10K12A1H  |

| Pos. | Molex PN:  | Engineering No.: |
|------|------------|------------------|
| 561  | 1210503257 | E452A3A10K12C3H  |
| 562  | 1210503258 | W452N3N30012C4H  |
| 563  | 1210503261 | E452N3N3001PC4M  |
| 564  | 1210503263 | W452B3A3001PA1H  |
| 565  | N/A        | N/A              |
| 566  | 1210503265 | E452A2A10011C4H  |
| 567  | 1210503266 | W452N2N30011C42  |
| 568  | 1210503267 | W452N2N25011C42  |
| 569  | 1210503268 | W452A3A50011C7H  |
| 570  | 1210503269 | W452N3N10012C4H  |
| 571  | 1210503270 | W452N3N50012C4L  |
| 572  | 1210503274 | E452N2N10K11C42  |
| 573  | 1210503275 | E452I4N30011C41  |
| 574  | 1210503277 | E452I4N30011C31  |
| 575  | N/A        | N/A              |
| 576  | 1210503286 | E452P3N3001PC4M  |
| 577  | 1210503287 | E452P3N3001PC4L  |
| 578  | 1210503326 | W452N3N90012C4H  |
| 579  | 1210503330 | E452I4N5001PC3H  |
| 580  | 1210503332 | E452P3N10K1PA1H  |
| 581  | 1210503333 | E452P3N20K1PA1H  |
| 582  | 1210503339 | E452P3N1001PC4M  |
| 583  | 1210503340 | E452I4G30011C3H  |
| 584  | 1210503341 | E452I4G50011C3H  |
| 585  | 1210503344 | E452B3A20K11S0H  |
| 586  | 1210503347 | E452N3N3001PC4G  |
| 587  | 1210503351 | E452N3N3001PA1G  |
| 588  | 1210503357 | E452N3N60011C4H  |
| 589  | 1210503359 | E452N3N1001PC42  |
| 590  | 1210503360 | E452N3N1001PC44  |
| 591  | 1210503361 | E452N3N1001PC45  |
| 592  | 1210503362 | E452N3N3001PC44  |
| 593  | 1210503363 | E452N3N3001PC45  |
| 594  | 1210503364 | E452N3N5001PC42  |
| 595  | 1210503365 | E452N3N5001PC44  |
| 596  | 1210503366 | E452N3N5001PC45  |
| 597  | 1210503403 | E452B3A06011A12  |
| 598  | 1210503411 | E452P3N1501PC4H  |
| 599  | 1210503415 | E452I4N40011C4L  |
| 600  | 1210503416 | E452I4G50011C4L  |

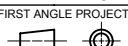
| Pos. | Molex PN:  | Engineering No.: |
|------|------------|------------------|
| 601  | N/A        | N/A              |
| 602  | 1210503424 | E452N2N2001RA1H  |
| 603  | 1210503435 | E452R4N4001PR2E  |
| 604  | 1210503441 | E452B2A1501PS3H  |
| 605  | 1210503442 | E452P3N30011C7H  |
| 606  | 1210503443 | E452N3N10011D05  |
| 607  | 1210503444 | E452P2N75011C4M  |
| 608  | 1210503445 | E452P2N16K11C4M  |
| 609  | 1210503446 | E452P2N22K11C4M  |
| 610  | 1210503463 | E452N3N05011C41  |
| 611  | 1210503464 | W452B2A1501PS3H  |
| 612  | 1210503467 | E452N3N05011C4A  |
| 613  | 1210503481 | E452N3N5001RS0H  |
| 614  | 1210503485 | E452I4N1001PC3H  |
| 615  | 1210503490 | E452N3N2001PC4B  |
| 616  | 1210503491 | E452A3A30011C7H  |
| 617  | 1210503497 | E452B2A10K1PC4H  |
| 618  | 1210503498 | E452B2A3001PC4H  |
| 619  | 1210503499 | E452B2A5001PC4H  |
| 620  | 1210503506 | E452B2A10K1PC4L  |
| 621  | 1210503507 | E452B2A3001PC4L  |
| 622  | 1210503508 | E452B2A5001PC4L  |
| 623  | 1210503509 | E452P3N30013C4D  |
| 624  | 1210503510 | E452P3N30013R2D  |
| 625  | 1210503512 | E452N3N10K1PC4H  |
| 626  | 1210503517 | E452N2N1501PS0H  |
| 627  | 1210503520 | W452P3N5001RC4D  |
| 628  | 1210503521 | W452P3N5001RC4E  |
| 629  | 1210503522 | E452P2N5001PS0H  |
| 630  | 1210510097 | E452N10261E3552  |
| 631  | 1210510106 | E452N30011C4214  |
| 632  | 1210510124 | E452P10011C4HBH  |
| 633  | 1210510133 | E452P20011C4HBH  |
| 634  | 1210510139 | E452P30011C4HBH  |
| 635  | 2210500959 | E452A2A10011000  |
| 636  | 2210500960 | E452A2A10011A11  |
| 637  | 2210500961 | E452A2A10011A12  |
| 638  | 2210500962 | E452A2A10011A13  |
| 639  | 2210500963 | E452A2A10011A14  |
| 640  | 2210500964 | E452A2A10011A15  |

|   |  |       |  |   |  |                |  |   |  |
|---|--|-------|--|---|--|----------------|--|---|--|
| THIS DRAWING CONTAINS INFORMATION THAT IS PROPRIETARY TO MOLEX ELECTRONIC TECHNOLOGIES, LLC AND SHOULD NOT BE USED WITHOUT WRITTEN PERMISSION |  |       |  |   |  |                |  |   |  |
| DIMENSION UNITS   |  | SCALE |  | CURRENT REV DESC: REVISION CREATED FOR REMOVING PRE-RELEASE STAMP |  |                |  | <br>E452XXXXXXXXXX<br>DIN FORM A EN 175301-803 |  |
| mm  |  | NTS   |  |   |  |                |  |   |  |
| GENERAL TOLERANCES (UNLESS SPECIFIED)   |  |       |  | EC NO: 714567   |  | 2022/07/18     |  | PRODUCT CUSTOMER DRAWING  |  |
|   |  |       |  | DRWN: SUGEEB  |  | 2022/07/19     |  |   |  |
|   |  |       |  | CHK'D: GGA  |  | 2022/07/19     |  | DOCUMENT NUMBER   |  |
|   |  |       |  | APPR: GGA   |  | 2022/07/19     |  |   |  |
|   |  |       |  | INITIAL REVISION:   |  |                |  | SD-121050-001   |  |
|   |  |       |  | DRWN: JMARSZALEK  |  | 2012/08/27     |  |   |  |
|   |  |       |  | APPR: MDYSZEWSKA  |  | 2012/08/20     |  | DOC TYPE  |  |
|   |  |       |  | FIRST ANGLE PROJECTION  |  | DRAWING        |  | DOC PART  |  |
|   |  |       |  | DRAFT WHERE APPLICABLE MUST REMAIN WITHIN DIMENSIONS              |  | SERIES         |  | REVISION  |  |
|   |  |       |  | A3-SIZE   |  | 121050         |  | PSD 001 E1  |  |
|   |  |       |  | MATERIAL NUMBER   |  | CUSTOMER       |  | SHEET NUMBER  |  |
|   |  |       |  | SEE TABLE   |  | GENERAL MARKET |  | 7 OF 41   |  |

TABLE 3 - PART LIST

| Pos. | Molex PN:  | Engineering No.: |
|------|------------|------------------|
| 641  | 2210500965 | E452A2A10011R02  |
| 642  | 2210500966 | E452A2A10011R03  |
| 643  | 2210500967 | E452A2A10011R04  |
| 644  | 2210500968 | E452A2A10011R05  |
| 645  | 2210500969 | E452A2A10011ROA  |
| 646  | 2210500970 | E452A2A10011ROB  |
| 647  | 2210500971 | E452A2A10011ROC  |
| 648  | 2210500972 | E452A2A10011ROD  |
| 649  | 2210500973 | E452A2A10011ROE  |
| 650  | 2210500974 | E452A2A10011ROG  |
| 651  | 2210500975 | E452A2A10011ROH  |
| 652  | 2210500976 | E452A2A10011ROK  |
| 653  | 2210500977 | E452A2A10011ROL  |
| 654  | 2210500978 | E452A2A10011ROM  |
| 655  | 2210500979 | E452A2A10011R21  |
| 656  | 2210500980 | E452A2A10011R22  |
| 657  | 2210500981 | E452A2A10011R23  |
| 658  | 2210500982 | E452A2A10011R24  |
| 659  | 2210500983 | E452A2A10011R25  |
| 660  | 2210500984 | E452A2A10011R2A  |
| 661  | 2210500985 | E452A2A10011R2B  |
| 662  | 2210500986 | E452A2A10011R2C  |
| 663  | 2210500987 | E452A2A10011R2D  |
| 664  | 2210500988 | E452A2A10011R2E  |
| 665  | 2210500989 | E452A2A10011R2G  |
| 666  | 2210500990 | E452A2A10011R2H  |
| 667  | 2210500991 | E452A2A10011R2K  |
| 668  | 2210500992 | E452A2A10011R2L  |
| 669  | 2210500993 | E452A2A10011R2M  |
| 670  | 2210500994 | E452A2A10011S01  |
| 671  | 2210500995 | E452A2A10011S02  |
| 672  | 2210500996 | E452A2A10011S03  |
| 673  | 2210500997 | E452A2A10011S04  |
| 674  | 2210500998 | E452A2A10011S05  |
| 675  | 2210500999 | E452A2A10011S0A  |
| 676  | 2210501000 | E452A2A10011S0B  |
| 677  | 2210501001 | E452A2A10011S0C  |
| 678  | 2210501002 | E452A2A10011S0D  |
| 679  | 2210501003 | E452A2A10011S0E  |
| 680  | 2210501008 | E452A2A10011S0G  |

| Pos. | Molex PN:  | Engineering No.: |
|------|------------|------------------|
| 681  | N/A        | N/A              |
| 682  | N/A        | N/A              |
| 683  | N/A        | N/A              |
| 684  | 2210501023 | E452A2A10011R05  |
| 685  | N/A        | N/A              |
| 686  | N/A        | N/A              |
| 687  | N/A        | N/A              |
| 688  | N/A        | N/A              |
| 689  | N/A        | N/A              |
| 690  | N/A        | N/A              |
| 691  | N/A        | N/A              |
| 692  | N/A        | N/A              |
| 693  | N/A        | N/A              |
| 694  | N/A        | N/A              |
| 695  | 2210501034 | E452A2A10011R21  |
| 696  | 2210501035 | E452A2A10011R22  |
| 697  | 2210501036 | E452A2A10011R23  |
| 698  | 2210501037 | E452A2A10011R24  |
| 699  | 2210501038 | E452A2A10011R25  |
| 700  | 2210501039 | E452A2A10011R2A  |
| 701  | 2210501040 | E452A2A10011R2B  |
| 702  | 2210501041 | E452A2A10011R2C  |
| 703  | 2210501042 | E452A2A10011R2D  |
| 704  | 2210501043 | E452A2A10011R2E  |
| 705  | 2210501044 | E452A2A10011R2G  |
| 706  | 2210501045 | E452A2A10011R2H  |
| 707  | 2210501046 | E452A2A10011R2K  |
| 708  | 2210501047 | E452A2A10011R2L  |
| 709  | 2210501048 | E452A2A10011R2M  |
| 710  | 2210501049 | E452A2A10011S01  |
| 711  | 2210501050 | E452A2A10011S02  |
| 712  | 2210501051 | E452A2A10011S03  |
| 713  | 2210501052 | E452A2A10011S04  |
| 714  | 2210501053 | E452A2A10011S05  |
| 715  | 2210501054 | E452A2A10011S0A  |
| 716  | 2210501055 | E452A2A10011S0B  |
| 717  | 2210501056 | E452A2A10011S0C  |
| 718  | 2210501057 | E452A2A10011S0D  |
| 719  | 2210501058 | E452A2A10011S0E  |
| 720  | 2210501059 | E452A2A10011S0G  |

| Pos. | Molex PN:  | Engineering No.: |
|------|------------|------------------|
| 721  | 2210501060 | E452A2A10011S0K  |
| 722  | 2210501061 | E452A2A10011S0L  |
| 723  | 2210501062 | E452A2A10011S0M  |
| 724  | 2210501063 | E452A2A10K11000  |
| 725  | 2210501064 | E452A2A10K11A11  |
| 726  | 2210501065 | E452A2A10K11A12  |
| 727  | 2210501066 | E452A2A10K11A13  |
| 728  | 2210501067 | E452A2A10K11A14  |
| 729  | 2210501068 | E452A2A10K11A15  |
| 730  | 2210501069 | E452A2A10K11A1A  |
| 731  | 2210501070 | E452A2A10K11A1B  |
| 732  | 2210501071 | E452A2A10K11A1C  |
| 733  | 2210501072 | E452A2A10K11A1D  |
| 734  | 2210501073 | E452A2A10K11A1E  |
| 735  | 2210501074 | E452A2A10K11A1G  |
| 736  | 2210501075 | E452A2A10K11A1H  |
| 737  | 2210501076 | E452A2A10K11A1K  |
| 738  | 2210501077 | E452A2A10K11A1L  |
| 739  | 2210501078 | E452A2A10K11A1M  |
| 740  | 2210501079 | E452A2A10K11C31  |
| 741  | 2210501080 | E452A2A10K11C32  |
| 742  | 2210501081 | E452A2A10K11C33  |
| 743  | 2210501082 | E452A2A10K11C34  |
| 744  | 2210501083 | E452A2A10K11C35  |
| 745  | 2210501084 | E452A2A10K11C3A  |
| 746  | 2210501085 | E452A2A10K11C3B  |
| 747  | 2210501086 | E452A2A10K11C3C  |
| 748  | 2210501087 | E452A2A10K11C3D  |
| 749  | 2210501088 | E452A2A10K11C3E  |
| 750  | 2210501089 | E452A2A10K11C3G  |
| 751  | 2210501090 | E452A2A10K11C3H  |
| 752  | 2210501091 | E452A2A10K11C3K  |
| 753  | 2210501092 | E452A2A10K11C3L  |
| 754  | 2210501093 | E452A2A10K11C3M  |
| 755  | 2210501094 | E452A2A10K11C41  |
| 756  | 2210501095 | E452A2A10K11C42  |
| 757  | 2210501096 | E452A2A10K11C43  |
| 758  | 2210501097 | E452A2A10K11C44  |
| 759  | 2210501098 | E452A2A10K11C45  |
| 760  | 2210501099 | E452A2A10K11C4A  |

| Pos. | Molex PN:  | Engineering No.: |
|------|------------|------------------|
| 761  | 2210501100 | E452A2A10K11C4B  |
| 762  | 2210501101 | E452A2A10K11C4C  |
| 763  | 2210501102 | E452A2A10K11C4D  |
| 764  | 2210501103 | E452A2A10K11C4E  |
| 765  | 2210501104 | E452A2A10K11C4G  |
| 766  | 2210501105 | E452A2A10K11C4H  |
| 767  | 2210501106 | E452A2A10K11C4K  |
| 768  | 2210501107 | E452A2A10K11C4L  |
| 769  | 2210501108 | E452A2A10K11C4M  |
| 770  | 2210501113 | E452A2A10K11E05  |
| 771  | N/A        | N/A              |
| 772  | N/A        | N/A              |
| 773  | N/A        | N/A              |
| 774  | N/A        | N/A              |
| 775  | 2210501128 | E452A2A10K11R05  |
| 776  | N/A        | N/A              |
| 777  | N/A        | N/A              |
| 778  | N/A        | N/A              |
| 779  | N/A        | N/A              |
| 780  | N/A        | N/A              |
| 781  | N/A        | N/A              |
| 782  | N/A        | N/A              |
| 783  | N/A        | N/A              |
| 784  | N/A        | N/A              |
| 785  | N/A        | N/A              |
| 786  | 2210501139 | E452A2A10K11R21  |
| 787  | 2210501140 | E452A2A10K11R22  |
| 788  | 2210501141 | E452A2A10K11R23  |
| 789  | 2210501142 | E452A2A10K11R24  |
| 790  | 2210501143 | E452A2A10K11R25  |
| 791  | 2210501144 | E452A2A10K11R2A  |
| 792  | 2210501145 | E452A2A10K11R2B  |
| 793  | 2210501146 | E452A2A10K11R2C  |
| 794  | 2210501147 | E452A2A10K11R2D  |
| 795  | 2210501148 | E452A2A10K11R2E  |
| 796  | 2210501149 | E452A2A10K11R2G  |
| 797  | 2210501150 | E452A2A10K11R2H  |
| 798  | 2210501151 | E452A2A10K11R2K  |
| 799  | 2210501152 | E452A2A10K11R2L  |
| 800  | 2210501153 | E452A2A10K11R2M  |

| Pos. | Molex PN:  | Engineering No.: |
|------|------------|------------------|
| 801  | 2210501154 | E452A2A10K11S01  |
| 802  | 2210501155 | E452A2A10K11S02  |
| 803  | 2210501156 | E452A2A10K11S03  |
| 804  | 2210501157 | E452A2A10K11S04  |
| 805  | 2210501158 | E452A2A10K11S05  |
| 806  | 2210501159 | E452A2A10K11S0A  |
| 807  | 2210501160 | E452A2A10K11S0B  |
| 808  | 2210501161 | E452A2A10K11S0C  |
| 809  | 2210501162 | E452A2A10K11S0D  |
| 810  | 2210501163 | E452A2A10K11S0E  |
| 811  | 2210501164 | E452A2A10K11S0G  |
| 812  | 2210501165 | E452A2A10K11S0K  |
| 813  | 2210501166 | E452A2A10K11S0M  |
| 814  | 2210501167 | E452A2A15011000  |
| 815  | 2210501168 | E452A2A15011A11  |
| 816  | 2210501169 | E452A2A15011A12  |
| 817  | 2210501170 | E452A2A15011A13  |
| 818  | 2210501171 | E452A2A15011A14  |
| 819  | 2210501172 | E452A2A15011A15  |
| 820  | 2210501173 | E452A2A15011A1A  |
| 821  | 2210501174 | E452A2A15011A1B  |
| 822  | 2210501175 | E452A2A15011A1C  |
| 823  | 2210501176 | E452A2A15011A1D  |
| 824  | 2210501177 | E452A2A15011A1E  |
| 825  | 2210501178 | E452A2A15011A1G  |
| 826  | 2210501179 | E452A2A15011A1H  |
| 827  | 2210501180 | E452A2A15011A1K  |
| 828  | 2210501181 | E452A2A15011A1L  |
| 829  | 2210501182 | E452A2A15011A1M  |
| 830  | 2210501183 | E452A2A15011C31  |
| 831  | 2210501184 | E452A2A15011C32  |
| 832  | 2210501185 | E452A2A15011C33  |
| 833  | 2210501186 | E452A2A15011C34  |
| 834  | 2210501187 | E452A2A15011C35  |
| 835  | 2210501188 | E452A2A15011C3A  |
| 836  | 2210501189 | E452A2A15011C3B  |
| 837  | 2210501190 | E452A2A15011C3C  |
| 838  | 2210501191 | E452A2A15011C3D  |
| 839  | 2210501192 | E452A2A15011C3E  |
| 840  | 2210501193 | E452A2A15011C3G  |

|   |  |       |  |   |  |            |  |   |  |
|---|--|-------|--|---|--|------------|--|---|--|
| THIS DRAWING CONTAINS INFORMATION THAT IS PROPRIETARY TO MOLEX ELECTRONIC TECHNOLOGIES, LLC AND SHOULD NOT BE USED WITHOUT WRITTEN PERMISSION |  |       |  |   |  |            |  |   |  |
| DIMENSION UNITS   |  | SCALE |  | CURRENT REV DESC: REVISION CREATED FOR REMOVING PRE-RELEASE STAMP                     |  |            |  | <br>E452XXXXXXXXXX<br>DIN FORM A EN 175301-803 |  |
| mm  |  | NTS   |  |   |  |            |  |   |  |
| GENERAL TOLERANCES (UNLESS SPECIFIED)   |  |       |  | EC NO: 714567   |  | 2022/07/18 |  | PRODUCT CUSTOMER DRAWING<br>DOCUMENT NUMBER: SD-121050-001<br>DOC TYPE: PSD<br>DOC PART: 001<br>REVISION: E1                        |  |
|   |  |       |  | DRWN: SUGEEB  |  | 2022/07/19 |  |   |  |
|   |  |       |  | CHK'D: GGA  |  | 2022/07/19 |  |   |  |
|   |  |       |  | APPR: GGA   |  |            |  |   |  |
|   |  |       |  | INITIAL REVISION:   |  |            |  |   |  |
|   |  |       |  | DRWN: JMARSZALEK  |  | 2012/08/27 |  |   |  |
|   |  |       |  | APPR: MDYSZEWSKA  |  | 2012/08/20 |  |   |  |
| DRAFT WHERE APPLICABLE MUST REMAIN WITHIN DIMENSIONS  |  |       |  | FIRST ANGLE PROJECTION  |  | DRAWING    |  | SHEET NUMBER  |  |
|   |  |       |  |  |  | A3-SIZE    |  | 8 OF 41   |  |

TABLE 3 - PART LIST

| Pos. | Molex PN:  | Engineering No.: |
|------|------------|------------------|
| 841  | 2210501194 | E452A2A15011C3H  |
| 842  | 2210501195 | E452A2A15011C3K  |
| 843  | 2210501196 | E452A2A15011C3L  |
| 844  | 2210501197 | E452A2A15011C3M  |
| 845  | 2210501198 | E452A2A15011C41  |
| 846  | 2210501199 | E452A2A15011C42  |
| 847  | 2210501200 | E452A2A15011C43  |
| 848  | 2210501201 | E452A2A15011C44  |
| 849  | 2210501202 | E452A2A15011C45  |
| 850  | 2210501203 | E452A2A15011C4A  |
| 851  | 2210501204 | E452A2A15011C4B  |
| 852  | 2210501205 | E452A2A15011C4C  |
| 853  | 2210501206 | E452A2A15011C4D  |
| 854  | 2210501207 | E452A2A15011C4E  |
| 855  | 2210501208 | E452A2A15011C4G  |
| 856  | 2210501209 | E452A2A15011C4K  |
| 857  | 2210501210 | E452A2A15011C4L  |
| 858  | 2210501211 | E452A2A15011C4M  |
| 859  | 2210501216 | E452A2A15011E05  |
| 860  | N/A        | N/A              |
| 861  | N/A        | N/A              |
| 862  | N/A        | N/A              |
| 863  | N/A        | N/A              |
| 864  | 2210501231 | E452A2A15011R05  |
| 865  | N/A        | N/A              |
| 866  | N/A        | N/A              |
| 867  | N/A        | N/A              |
| 868  | N/A        | N/A              |
| 869  | N/A        | N/A              |
| 870  | N/A        | N/A              |
| 871  | N/A        | N/A              |
| 872  | N/A        | N/A              |
| 873  | N/A        | N/A              |
| 874  | N/A        | N/A              |
| 875  | 2210501242 | E452A2A15011R21  |
| 876  | 2210501243 | E452A2A15011R22  |
| 877  | 2210501244 | E452A2A15011R23  |
| 878  | 2210501245 | E452A2A15011R24  |
| 879  | 2210501246 | E452A2A15011R25  |
| 880  | 2210501247 | E452A2A15011R2A  |

| Pos. | Molex PN:  | Engineering No.: |
|------|------------|------------------|
| 881  | 2210501248 | E452A2A15011R2B  |
| 882  | 2210501249 | E452A2A15011R2C  |
| 883  | 2210501250 | E452A2A15011R2D  |
| 884  | 2210501251 | E452A2A15011R2E  |
| 885  | 2210501252 | E452A2A15011R2G  |
| 886  | 2210501253 | E452A2A15011R2H  |
| 887  | 2210501254 | E452A2A15011R2K  |
| 888  | 2210501255 | E452A2A15011R2L  |
| 889  | 2210501256 | E452A2A15011R2M  |
| 890  | 2210501257 | E452A2A15011S01  |
| 891  | 2210501258 | E452A2A15011S02  |
| 892  | 2210501259 | E452A2A15011S03  |
| 893  | 2210501260 | E452A2A15011S04  |
| 894  | 2210501261 | E452A2A15011S05  |
| 895  | 2210501262 | E452A2A15011S0A  |
| 896  | 2210501263 | E452A2A15011S0B  |
| 897  | 2210501264 | E452A2A15011S0C  |
| 898  | 2210501265 | E452A2A15011S0D  |
| 899  | 2210501266 | E452A2A15011S0E  |
| 900  | 2210501267 | E452A2A15011S0G  |
| 901  | 2210501268 | E452A2A15011S0K  |
| 902  | 2210501269 | E452A2A15011S0L  |
| 903  | 2210501270 | E452A2A15011S0M  |
| 904  | 2210501271 | E452A2A20011000  |
| 905  | 2210501272 | E452A2A20011A11  |
| 906  | 2210501273 | E452A2A20011A12  |
| 907  | 2210501274 | E452A2A20011A13  |
| 908  | 2210501275 | E452A2A20011A14  |
| 909  | 2210501276 | E452A2A20011A15  |
| 910  | 2210501277 | E452A2A20011A1A  |
| 911  | 2210501278 | E452A2A20011A1B  |
| 912  | 2210501279 | E452A2A20011A1C  |
| 913  | 2210501280 | E452A2A20011A1D  |
| 914  | 2210501281 | E452A2A20011A1E  |
| 915  | 2210501282 | E452A2A20011A1G  |
| 916  | 2210501283 | E452A2A20011A1H  |
| 917  | 2210501284 | E452A2A20011A1K  |
| 918  | 2210501285 | E452A2A20011A1L  |
| 919  | 2210501286 | E452A2A20011A1M  |
| 920  | 2210501287 | E452A2A20011C31  |

| Pos. | Molex PN:  | Engineering No.: |
|------|------------|------------------|
| 921  | 2210501288 | E452A2A20011C32  |
| 922  | 2210501289 | E452A2A20011C33  |
| 923  | 2210501290 | E452A2A20011C34  |
| 924  | 2210501291 | E452A2A20011C35  |
| 925  | 2210501292 | E452A2A20011C3A  |
| 926  | 2210501293 | E452A2A20011C3B  |
| 927  | 2210501294 | E452A2A20011C3C  |
| 928  | 2210501295 | E452A2A20011C3D  |
| 929  | 2210501296 | E452A2A20011C3E  |
| 930  | 2210501297 | E452A2A20011C3G  |
| 931  | 2210501298 | E452A2A20011C3H  |
| 932  | 2210501299 | E452A2A20011C3K  |
| 933  | 2210501300 | E452A2A20011C3L  |
| 934  | 2210501301 | E452A2A20011C3M  |
| 935  | 2210501302 | E452A2A20011C41  |
| 936  | 2210501303 | E452A2A20011C42  |
| 937  | 2210501304 | E452A2A20011C43  |
| 938  | 2210501305 | E452A2A20011C44  |
| 939  | 2210501306 | E452A2A20011C45  |
| 940  | 2210501307 | E452A2A20011C4A  |
| 941  | 2210501308 | E452A2A20011C4B  |
| 942  | 2210501309 | E452A2A20011C4C  |
| 943  | 2210501310 | E452A2A20011C4D  |
| 944  | 2210501311 | E452A2A20011C4E  |
| 945  | 2210501312 | E452A2A20011C4G  |
| 946  | 2210501313 | E452A2A20011C4K  |
| 947  | 2210501314 | E452A2A20011C4L  |
| 948  | 2210501315 | E452A2A20011C4M  |
| 949  | 2210501320 | E452A2A20011E05  |
| 950  | N/A        | N/A              |
| 951  | N/A        | N/A              |
| 952  | N/A        | N/A              |
| 953  | N/A        | N/A              |
| 954  | 2210501335 | E452A2A20011R05  |
| 955  | N/A        | N/A              |
| 956  | N/A        | N/A              |
| 957  | N/A        | N/A              |
| 958  | N/A        | N/A              |
| 959  | N/A        | N/A              |
| 960  | N/A        | N/A              |

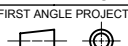
| Pos. | Molex PN:  | Engineering No.: |
|------|------------|------------------|
| 961  | N/A        | N/A              |
| 962  | N/A        | N/A              |
| 963  | N/A        | N/A              |
| 964  | N/A        | N/A              |
| 965  | 2210501346 | E452A2A20011R21  |
| 966  | 2210501347 | E452A2A20011R22  |
| 967  | 2210501348 | E452A2A20011R23  |
| 968  | 2210501349 | E452A2A20011R24  |
| 969  | 2210501350 | E452A2A20011R25  |
| 970  | 2210501351 | E452A2A20011R2A  |
| 971  | 2210501352 | E452A2A20011R2B  |
| 972  | 2210501353 | E452A2A20011R2C  |
| 973  | 2210501354 | E452A2A20011R2D  |
| 974  | 2210501355 | E452A2A20011R2E  |
| 975  | 2210501356 | E452A2A20011R2G  |
| 976  | 2210501357 | E452A2A20011R2H  |
| 977  | 2210501358 | E452A2A20011R2K  |
| 978  | 2210501359 | E452A2A20011R2L  |
| 979  | 2210501360 | E452A2A20011R2M  |
| 980  | 2210501361 | E452A2A20011S01  |
| 981  | 2210501362 | E452A2A20011S02  |
| 982  | 2210501363 | E452A2A20011S03  |
| 983  | 2210501364 | E452A2A20011S04  |
| 984  | 2210501365 | E452A2A20011S05  |
| 985  | 2210501366 | E452A2A20011S0A  |
| 986  | 2210501367 | E452A2A20011S0B  |
| 987  | 2210501368 | E452A2A20011S0C  |
| 988  | 2210501369 | E452A2A20011S0D  |
| 989  | 2210501370 | E452A2A20011S0E  |
| 990  | 2210501371 | E452A2A20011S0G  |
| 991  | 2210501372 | E452A2A20011S0K  |
| 992  | 2210501373 | E452A2A20011S0L  |
| 993  | 2210501374 | E452A2A20011S0M  |
| 994  | 2210501375 | E452A2A30011000  |
| 995  | 2210501376 | E452A2A30011A11  |
| 996  | 2210501377 | E452A2A30011A12  |
| 997  | 2210501378 | E452A2A30011A13  |
| 998  | 2210501379 | E452A2A30011A14  |
| 999  | 2210501380 | E452A2A30011A15  |
| 1000 | 2210501381 | E452A2A30011A1A  |

|   |  |                     |  |   |  |                 |  |   |  |
|---|--|---------------------|--|---|--|-----------------|--|---|--|
| THIS DRAWING CONTAINS INFORMATION THAT IS PROPRIETARY TO MOLEX ELECTRONIC TECHNOLOGIES, LLC AND SHOULD NOT BE USED WITHOUT WRITTEN PERMISSION |  |                     |  |   |  |                 |  |   |  |
| DIMENSION UNITS<br><b>mm</b>  |  | SCALE<br><b>NTS</b> |  | CURRENT REV DESC: REVISION CREATED FOR REMOVING PRE-RELEASE STAMP                     |  |                 |  | <br>E452XXXXXXXXXX<br>DIN FORM A EN 175301-803 |  |
| GENERAL TOLERANCES (UNLESS SPECIFIED)   |  |                     |  | EC NO: 714567   |  | 2022/07/18      |  |   |  |
|   |  |                     |  | DRWN: SUGEEB  |  | 2022/07/19      |  | PRODUCT CUSTOMER DRAWING  |  |
| 4 PLACES ±  |  | ±                   |  | CHK'D: GGA  |  | 2022/07/19      |  | DOCUMENT NUMBER   |  |
| 3 PLACES ±  |  | ±                   |  | APPR: GGA   |  | 2022/07/19      |  | SD-121050-001   |  |
| 2 PLACES ±  |  | ±                   |  | INITIAL REVISION:   |  |                 |  | DOC TYPE  |  |
| 1 PLACE ±   |  | ±                   |  | DRWN: JMARSZALEK  |  | 2012/08/27      |  | DOC PART  |  |
| 0 PLACES ±  |  | ±                   |  | APPR: MDYSZEWSKA  |  | 2012/08/20      |  | REVISION  |  |
| ANGULAR TOL ± °   |  | ± °                 |  |   |  |                 |  | E1  |  |
| DRAFT WHERE APPLICABLE MUST REMAIN WITHIN DIMENSIONS  |  |                     |  | FIRST ANGLE PROJECTION  |  | DRAWING         |  | SHEET NUMBER  |  |
|   |  |                     |  |  |  | A3-SIZE         |  | 9 OF 41   |  |
|   |  |                     |  | SERIES  |  | MATERIAL NUMBER |  | CUSTOMER  |  |
|   |  |                     |  | 121050  |  | SEE TABLE       |  | GENERAL MARKET  |  |

TABLE 3 - PART LIST

| Pos. | Molex PN:  | Engineering No.: |
|------|------------|------------------|
| 1001 | 2210501382 | E452A2A30011A1B  |
| 1002 | 2210501383 | E452A2A30011A1C  |
| 1003 | 2210501384 | E452A2A30011A1D  |
| 1004 | 2210501385 | E452A2A30011A1E  |
| 1005 | 2210501386 | E452A2A30011A1G  |
| 1006 | 2210501387 | E452A2A30011A1H  |
| 1007 | 2210501388 | E452A2A30011A1K  |
| 1008 | 2210501389 | E452A2A30011A1L  |
| 1009 | 2210501390 | E452A2A30011A1M  |
| 1010 | 2210501391 | E452A2A30011C31  |
| 1011 | 2210501392 | E452A2A30011C33  |
| 1012 | 2210501393 | E452A2A30011C34  |
| 1013 | 2210501394 | E452A2A30011C35  |
| 1014 | 2210501395 | E452A2A30011C3A  |
| 1015 | 2210501396 | E452A2A30011C3B  |
| 1016 | 2210501397 | E452A2A30011C3C  |
| 1017 | 2210501398 | E452A2A30011C3D  |
| 1018 | 2210501399 | E452A2A30011C3E  |
| 1019 | 2210501400 | E452A2A30011C3G  |
| 1020 | 2210501401 | E452A2A30011C3H  |
| 1021 | 2210501402 | E452A2A30011C3K  |
| 1022 | 2210501403 | E452A2A30011C3L  |
| 1023 | 2210501404 | E452A2A30011C3M  |
| 1024 | 2210501405 | E452A2A30011C41  |
| 1025 | 2210501406 | E452A2A30011C42  |
| 1026 | 2210501407 | E452A2A30011C43  |
| 1027 | 2210501408 | E452A2A30011C44  |
| 1028 | 2210501409 | E452A2A30011C45  |
| 1029 | 2210501410 | E452A2A30011C4A  |
| 1030 | 2210501411 | E452A2A30011C4B  |
| 1031 | 2210501412 | E452A2A30011C4C  |
| 1032 | 2210501413 | E452A2A30011C4D  |
| 1033 | 2210501414 | E452A2A30011C4E  |
| 1034 | 2210501415 | E452A2A30011C4G  |
| 1035 | 2210501416 | E452A2A30011C4K  |
| 1036 | 2210501417 | E452A2A30011C4L  |
| 1037 | 2210501418 | E452A2A30011C4M  |
| 1038 | 2210501423 | E452A2A30011E05  |
| 1039 | N/A        | N/A              |
| 1040 | N/A        | N/A              |

| Pos. | Molex PN:  | Engineering No.: |
|------|------------|------------------|
| 1041 | N/A        | N/A              |
| 1042 | N/A        | N/A              |
| 1043 | 2210501438 | E452A2A30011R05  |
| 1044 | N/A        | N/A              |
| 1045 | N/A        | N/A              |
| 1046 | N/A        | N/A              |
| 1047 | N/A        | N/A              |
| 1048 | N/A        | N/A              |
| 1049 | N/A        | N/A              |
| 1050 | N/A        | N/A              |
| 1051 | N/A        | N/A              |
| 1052 | N/A        | N/A              |
| 1053 | N/A        | N/A              |
| 1054 | 2210501449 | E452A2A30011R21  |
| 1055 | 2210501450 | E452A2A30011R22  |
| 1056 | 2210501451 | E452A2A30011R23  |
| 1057 | 2210501452 | E452A2A30011R24  |
| 1058 | 2210501453 | E452A2A30011R25  |
| 1059 | 2210501454 | E452A2A30011R2A  |
| 1060 | 2210501455 | E452A2A30011R2B  |
| 1061 | 2210501456 | E452A2A30011R2C  |
| 1062 | 2210501457 | E452A2A30011R2D  |
| 1063 | 2210501458 | E452A2A30011R2E  |
| 1064 | 2210501459 | E452A2A30011R2G  |
| 1065 | 2210501460 | E452A2A30011R2H  |
| 1066 | 2210501461 | E452A2A30011R2K  |
| 1067 | 2210501462 | E452A2A30011R2L  |
| 1068 | 2210501463 | E452A2A30011R2M  |
| 1069 | 2210501464 | E452A2A30011S01  |
| 1070 | 2210501465 | E452A2A30011S02  |
| 1071 | 2210501466 | E452A2A30011S03  |
| 1072 | 2210501467 | E452A2A30011S04  |
| 1073 | 2210501468 | E452A2A30011S05  |
| 1074 | 2210501469 | E452A2A30011S0A  |
| 1075 | 2210501470 | E452A2A30011S0B  |
| 1076 | 2210501471 | E452A2A30011S0C  |
| 1077 | 2210501472 | E452A2A30011S0D  |
| 1078 | 2210501473 | E452A2A30011S0E  |
| 1079 | 2210501474 | E452A2A30011S0G  |
| 1080 | 2210501475 | E452A2A30011S0K  |

| Pos. | Molex PN:  | Engineering No.: |
|------|------------|------------------|
| 1081 | 2210501476 | E452A2A30011S0L  |
| 1082 | 2210501477 | E452A2A30011S0M  |
| 1083 | 2210501478 | E452A2A50011000  |
| 1084 | 2210501479 | E452A2A50011A11  |
| 1085 | 2210501480 | E452A2A50011A12  |
| 1086 | 2210501481 | E452A2A50011A13  |
| 1087 | 2210501482 | E452A2A50011A14  |
| 1088 | 2210501483 | E452A2A50011A15  |
| 1089 | 2210501484 | E452A2A50011A1A  |
| 1090 | 2210501485 | E452A2A50011A1B  |
| 1091 | 2210501486 | E452A2A50011A1C  |
| 1092 | 2210501487 | E452A2A50011A1D  |
| 1093 | 2210501488 | E452A2A50011A1E  |
| 1094 | 2210501489 | E452A2A50011A1G  |
| 1095 | 2210501490 | E452A2A50011A1H  |
| 1096 | 2210501491 | E452A2A50011A1K  |
| 1097 | 2210501492 | E452A2A50011A1L  |
| 1098 | 2210501493 | E452A2A50011A1M  |
| 1099 | 2210501494 | E452A2A50011C31  |
| 1100 | 2210501495 | E452A2A50011C32  |
| 1101 | 2210501496 | E452A2A50011C33  |
| 1102 | 2210501497 | E452A2A50011C34  |
| 1103 | 2210501498 | E452A2A50011C35  |
| 1104 | 2210501499 | E452A2A50011C3A  |
| 1105 | 2210501500 | E452A2A50011C3B  |
| 1106 | 2210501501 | E452A2A50011C3C  |
| 1107 | 2210501502 | E452A2A50011C3D  |
| 1108 | 2210501503 | E452A2A50011C3E  |
| 1109 | 2210501504 | E452A2A50011C3G  |
| 1110 | 2210501505 | E452A2A50011C3H  |
| 1111 | 2210501506 | E452A2A50011C3K  |
| 1112 | 2210501507 | E452A2A50011C3L  |
| 1113 | 2210501508 | E452A2A50011C3M  |
| 1114 | 2210501509 | E452A2A50011C41  |
| 1115 | 2210501510 | E452A2A50011C42  |
| 1116 | 2210501511 | E452A2A50011C43  |
| 1117 | 2210501512 | E452A2A50011C44  |
| 1118 | 2210501513 | E452A2A50011C45  |
| 1119 | 2210501514 | E452A2A50011C4A  |
| 1120 | 2210501515 | E452A2A50011C4B  |

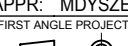
| Pos. | Molex PN:  | Engineering No.: |
|------|------------|------------------|
| 1121 | 2210501516 | E452A2A50011C4C  |
| 1122 | 2210501517 | E452A2A50011C4D  |
| 1123 | 2210501518 | E452A2A50011C4E  |
| 1124 | 2210501519 | E452A2A50011C4G  |
| 1125 | 2210501520 | E452A2A50011C4H  |
| 1126 | 2210501521 | E452A2A50011C4K  |
| 1127 | 2210501522 | E452A2A50011C4L  |
| 1128 | 2210501523 | E452A2A50011C4M  |
| 1129 | 2210501528 | E452A2A50011E05  |
| 1130 | N/A        | N/A              |
| 1131 | N/A        | N/A              |
| 1132 | N/A        | N/A              |
| 1133 | N/A        | N/A              |
| 1134 | 2210501543 | E452A2A50011R05  |
| 1135 | N/A        | N/A              |
| 1136 | N/A        | N/A              |
| 1137 | N/A        | N/A              |
| 1138 | N/A        | N/A              |
| 1139 | N/A        | N/A              |
| 1140 | N/A        | N/A              |
| 1141 | N/A        | N/A              |
| 1142 | N/A        | N/A              |
| 1143 | N/A        | N/A              |
| 1144 | N/A        | N/A              |
| 1145 | 2210501554 | E452A2A50011R21  |
| 1146 | 2210501555 | E452A2A50011R22  |
| 1147 | 2210501556 | E452A2A50011R23  |
| 1148 | 2210501557 | E452A2A50011R24  |
| 1149 | 2210501558 | E452A2A50011R25  |
| 1150 | 2210501559 | E452A2A50011R2A  |
| 1151 | 2210501560 | E452A2A50011R2B  |
| 1152 | 2210501561 | E452A2A50011R2C  |
| 1153 | 2210501562 | E452A2A50011R2D  |
| 1154 | 2210501563 | E452A2A50011R2E  |
| 1155 | 2210501564 | E452A2A50011R2G  |
| 1156 | 2210501565 | E452A2A50011R2H  |
| 1157 | 2210501566 | E452A2A50011R2K  |
| 1158 | 2210501567 | E452A2A50011R2L  |
| 1159 | 2210501568 | E452A2A50011R2M  |
| 1160 | 2210501569 | E452A2A50011S01  |

|   |  |       |    |   |   |            |         |   |        |
|---|--|-------|----|---|---|------------|---------|---|--------|
| THIS DRAWING CONTAINS INFORMATION THAT IS PROPRIETARY TO MOLEX ELECTRONIC TECHNOLOGIES, LLC AND SHOULD NOT BE USED WITHOUT WRITTEN PERMISSION |  |       |    |   |   |            |         |   |        |
| DIMENSION UNITS   |  | SCALE |    | CURRENT REV DESC: REVISION CREATED FOR REMOVING PRE-RELEASE STAMP |   |            |         | <br>E452XXXXXXXXXX<br>DIN FORM A EN 175301-803 |        |
| mm  |  | NTS   |    |   |   |            |         |   |        |
| GENERAL TOLERANCES (UNLESS SPECIFIED)   |  |       |    |   |   |            |         |   |        |
|   |  | MM    |    | INCH  |   |            |         |   |        |
| 4 PLACES  |  | ±     |    | ±   |   |            |         |   |        |
| 3 PLACES  |  | ±     |    | ±   |   |            |         |   |        |
| 2 PLACES  |  | ±     |    | ±   |   |            |         |   |        |
| 1 PLACE   |  | ±     |    | ±   |   |            |         |   |        |
| 0 PLACES  |  | ±     |    | ±   |   |            |         |   |        |
| ANGULAR TOL   |  | ±     |    | °   |   |            |         |   |        |
| DRAFT WHERE APPLICABLE MUST REMAIN WITHIN DIMENSIONS  |  |       |    |   | FIRST ANGLE PROJECTION  |            | DRAWING |   | SERIES |
|   |  |       |    |   |  |            | A3-SIZE |   | 121050 |
| DOCUMENT STATUS   |  |       | P1 | RELEASE DATE  |   | 2022/07/19 |         | 09:04:35  |        |

TABLE 3 - PART LIST

| Pos. | Molex PN:  | Engineering No.: |
|------|------------|------------------|
| 1161 | 2210501570 | E452A2A50011S02  |
| 1162 | 2210501571 | E452A2A50011S03  |
| 1163 | 2210501572 | E452A2A50011S04  |
| 1164 | 2210501573 | E452A2A50011S05  |
| 1165 | 2210501574 | E452A2A50011S0A  |
| 1166 | 2210501575 | E452A2A50011S0B  |
| 1167 | 2210501576 | E452A2A50011S0C  |
| 1168 | 2210501577 | E452A2A50011S0D  |
| 1169 | 2210501578 | E452A2A50011S0E  |
| 1170 | 2210501579 | E452A2A50011S0G  |
| 1171 | 2210501580 | E452A2A50011S0K  |
| 1172 | 2210501581 | E452A2A50011S0L  |
| 1173 | 2210501582 | E452A2A50011S0M  |
| 1174 | 2210501583 | E452A3A10011000  |
| 1175 | 2210501584 | E452A3A10011A11  |
| 1176 | 2210501585 | E452A3A10011A12  |
| 1177 | 2210501586 | E452A3A10011A13  |
| 1178 | 2210501587 | E452A3A10011A14  |
| 1179 | 2210501588 | E452A3A10011A15  |
| 1180 | 2210501589 | E452A3A10011A1A  |
| 1181 | 2210501590 | E452A3A10011A1B  |
| 1182 | 2210501591 | E452A3A10011A1C  |
| 1183 | 2210501592 | E452A3A10011A1D  |
| 1184 | 2210501593 | E452A3A10011A1E  |
| 1185 | 2210501594 | E452A3A10011A1G  |
| 1186 | 2210501595 | E452A3A10011A1H  |
| 1187 | 2210501596 | E452A3A10011A1K  |
| 1188 | 2210501597 | E452A3A10011A1L  |
| 1189 | 2210501598 | E452A3A10011A1M  |
| 1190 | 2210501599 | E452A3A10011C31  |
| 1191 | 2210501600 | E452A3A10011C32  |
| 1192 | 2210501601 | E452A3A10011C33  |
| 1193 | 2210501602 | E452A3A10011C34  |
| 1194 | 2210501603 | E452A3A10011C35  |
| 1195 | 2210501604 | E452A3A10011C3A  |
| 1196 | 2210501605 | E452A3A10011C3B  |
| 1197 | 2210501606 | E452A3A10011C3C  |
| 1198 | 2210501607 | E452A3A10011C3D  |
| 1199 | 2210501608 | E452A3A10011C3E  |
| 1200 | 2210501609 | E452A3A10011C3G  |

| Pos. | Molex PN:  | Engineering No.: |
|------|------------|------------------|
| 1201 | 2210501610 | E452A3A10011C3H  |
| 1202 | 2210501611 | E452A3A10011C3K  |
| 1203 | 2210501612 | E452A3A10011C3L  |
| 1204 | 2210501613 | E452A3A10011C3M  |
| 1205 | 2210501614 | E452A3A10011C41  |
| 1206 | 2210501615 | E452A3A10011C43  |
| 1207 | 2210501616 | E452A3A10011C44  |
| 1208 | 2210501617 | E452A3A10011C45  |
| 1209 | 2210501618 | E452A3A10011C4A  |
| 1210 | 2210501619 | E452A3A10011C4B  |
| 1211 | 2210501620 | E452A3A10011C4C  |
| 1212 | 2210501621 | E452A3A10011C4D  |
| 1213 | 2210501622 | E452A3A10011C4E  |
| 1214 | 2210501623 | E452A3A10011C4G  |
| 1215 | 2210501624 | E452A3A10011C4H  |
| 1216 | 2210501625 | E452A3A10011C4K  |
| 1217 | 2210501626 | E452A3A10011C4L  |
| 1218 | 2210501627 | E452A3A10011C4M  |
| 1219 | 2210501632 | E452A3A10011E05  |
| 1220 | N/A        | N/A              |
| 1221 | N/A        | N/A              |
| 1222 | N/A        | N/A              |
| 1223 | N/A        | N/A              |
| 1224 | 2210501647 | E452A3A10011R05  |
| 1225 | N/A        | N/A              |
| 1226 | N/A        | N/A              |
| 1227 | N/A        | N/A              |
| 1228 | N/A        | N/A              |
| 1229 | N/A        | N/A              |
| 1230 | N/A        | N/A              |
| 1231 | N/A        | N/A              |
| 1232 | N/A        | N/A              |
| 1233 | N/A        | N/A              |
| 1234 | N/A        | N/A              |
| 1235 | 2210501658 | E452A3A10011R21  |
| 1236 | 2210501659 | E452A3A10011R22  |
| 1237 | 2210501660 | E452A3A10011R23  |
| 1238 | 2210501661 | E452A3A10011R24  |
| 1239 | 2210501662 | E452A3A10011R25  |
| 1240 | 2210501663 | E452A3A10011R2A  |

| Pos. | Molex PN:  | Engineering No.: |
|------|------------|------------------|
| 1241 | 2210501664 | E452A3A10011R2B  |
| 1242 | 2210501665 | E452A3A10011R2C  |
| 1243 | 2210501666 | E452A3A10011R2D  |
| 1244 | 2210501667 | E452A3A10011R2E  |
| 1245 | 2210501668 | E452A3A10011R2G  |
| 1246 | 2210501669 | E452A3A10011R2H  |
| 1247 | 2210501670 | E452A3A10011R2K  |
| 1248 | 2210501671 | E452A3A10011R2L  |
| 1249 | 2210501672 | E452A3A10011R2M  |
| 1250 | 2210501673 | E452A3A10011S01  |
| 1251 | 2210501674 | E452A3A10011S02  |
| 1252 | 2210501675 | E452A3A10011S03  |
| 1253 | 2210501676 | E452A3A10011S04  |
| 1254 | 2210501677 | E452A3A10011S05  |
| 1255 | 2210501678 | E452A3A10011S0A  |
| 1256 | 2210501679 | E452A3A10011S0B  |
| 1257 | 2210501680 | E452A3A10011S0C  |
| 1258 | 2210501681 | E452A3A10011S0D  |
| 1259 | 2210501682 | E452A3A10011S0E  |
| 1260 | 2210501683 | E452A3A10011S0G  |
| 1261 | 2210501684 | E452A3A10011S0H  |
| 1262 | 2210501685 | E452A3A10011S0K  |
| 1263 | 2210501686 | E452A3A10011S0L  |
| 1264 | 2210501687 | E452A3A10011S0M  |
| 1265 | 2210501688 | E452A3A10K11000  |
| 1266 | 2210501689 | E452A3A10K11A11  |
| 1267 | 2210501690 | E452A3A10K11A12  |
| 1268 | 2210501691 | E452A3A10K11A13  |
| 1269 | 2210501692 | E452A3A10K11A14  |
| 1270 | 2210501693 | E452A3A10K11A15  |
| 1271 | 2210501694 | E452A3A10K11A1A  |
| 1272 | 2210501695 | E452A3A10K11A1B  |
| 1273 | 2210501696 | E452A3A10K11A1C  |
| 1274 | 2210501697 | E452A3A10K11A1D  |
| 1275 | 2210501698 | E452A3A10K11A1E  |
| 1276 | 2210501699 | E452A3A10K11A1G  |
| 1277 | 2210501700 | E452A3A10K11A1H  |
| 1278 | 2210501701 | E452A3A10K11A1K  |
| 1279 | 2210501702 | E452A3A10K11A1L  |
| 1280 | 2210501703 | E452A3A10K11A1M  |

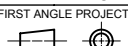
| Pos. | Molex PN:  | Engineering No.: |
|------|------------|------------------|
| 1281 | 2210501704 | E452A3A10K11C31  |
| 1282 | 2210501705 | E452A3A10K11C32  |
| 1283 | 2210501706 | E452A3A10K11C33  |
| 1284 | 2210501707 | E452A3A10K11C34  |
| 1285 | 2210501708 | E452A3A10K11C35  |
| 1286 | 2210501709 | E452A3A10K11C3A  |
| 1287 | 2210501710 | E452A3A10K11C3B  |
| 1288 | 2210501711 | E452A3A10K11C3C  |
| 1289 | 2210501712 | E452A3A10K11C3D  |
| 1290 | 2210501713 | E452A3A10K11C3E  |
| 1291 | 2210501714 | E452A3A10K11C3G  |
| 1292 | 2210501715 | E452A3A10K11C3H  |
| 1293 | 2210501716 | E452A3A10K11C3K  |
| 1294 | 2210501717 | E452A3A10K11C3L  |
| 1295 | 2210501718 | E452A3A10K11C3M  |
| 1296 | 2210501719 | E452A3A10K11C41  |
| 1297 | 2210501720 | E452A3A10K11C42  |
| 1298 | 2210501721 | E452A3A10K11C43  |
| 1299 | 2210501722 | E452A3A10K11C44  |
| 1300 | 2210501723 | E452A3A10K11C45  |
| 1301 | 2210501724 | E452A3A10K11C4A  |
| 1302 | 2210501725 | E452A3A10K11C4B  |
| 1303 | 2210501726 | E452A3A10K11C4C  |
| 1304 | 2210501727 | E452A3A10K11C4D  |
| 1305 | 2210501728 | E452A3A10K11C4E  |
| 1306 | 2210501729 | E452A3A10K11C4G  |
| 1307 | 2210501730 | E452A3A10K11C4H  |
| 1308 | 2210501731 | E452A3A10K11C4K  |
| 1309 | 2210501732 | E452A3A10K11C4L  |
| 1310 | 2210501733 | E452A3A10K11C4M  |
| 1311 | 2210501738 | E452A3A10K11E05  |
| 1312 | N/A        | N/A              |
| 1313 | N/A        | N/A              |
| 1314 | N/A        | N/A              |
| 1315 | N/A        | N/A              |
| 1316 | 2210501753 | E452A3A10K11R05  |
| 1317 | N/A        | N/A              |
| 1318 | N/A        | N/A              |
| 1319 | N/A        | N/A              |
| 1320 | N/A        | N/A              |

|   |  |       |  |   |  |            |  |   |  |
|---|--|-------|--|---|--|------------|--|---|--|
| THIS DRAWING CONTAINS INFORMATION THAT IS PROPRIETARY TO MOLEX ELECTRONIC TECHNOLOGIES, LLC AND SHOULD NOT BE USED WITHOUT WRITTEN PERMISSION |  |       |  |   |  |            |  |   |  |
| DIMENSION UNITS   |  | SCALE |  | CURRENT REV DESC: REVISION CREATED FOR REMOVING PRE-RELEASE STAMP                     |  |            |  | <br>E452XXXXXXXXXX<br>DIN FORM A EN 175301-803 |  |
| mm  |  | NTS   |  |   |  |            |  |   |  |
| GENERAL TOLERANCES (UNLESS SPECIFIED)   |  |       |  | EC NO: 714567   |  | 2022/07/18 |  | PRODUCT CUSTOMER DRAWING  |  |
|   |  |       |  | DRWN: SUGEEB  |  | 2022/07/19 |  |   |  |
|   |  |       |  | CHK'D: GGA  |  | 2022/07/19 |  | DOCUMENT NUMBER<br><b>SD-121050-001</b>   |  |
|   |  |       |  | APPR: GGA   |  | 2022/07/19 |  |   |  |
|   |  |       |  | INITIAL REVISION:   |  | 2012/08/27 |  | DOC TYPE DOC PART REVISION<br>PSD 001 E1  |  |
|   |  |       |  | DRWN: JMARSZALEK  |  | 2012/08/27 |  |   |  |
|   |  |       |  | APPR: MDYSZEWSKA  |  | 2012/08/20 |  | MATERIAL NUMBER<br>SEE TABLE  |  |
|   |  |       |  | ANGULAR TOL ± °   |  |            |  |   |  |
| DRAFT WHERE APPLICABLE MUST REMAIN WITHIN DIMENSIONS  |  |       |  | FIRST ANGLE PROJECTION  |  | DRAWING    |  | SHEET NUMBER  |  |
|   |  |       |  |  |  | A3-SIZE    |  | 11 OF 41  |  |

TABLE 3 - PART LIST

| Pos. | Molex PN:  | Engineering No.: |
|------|------------|------------------|
| 1321 | N/A        | N/A              |
| 1322 | N/A        | N/A              |
| 1323 | N/A        | N/A              |
| 1324 | N/A        | N/A              |
| 1325 | N/A        | N/A              |
| 1326 | N/A        | N/A              |
| 1327 | 2210501764 | E452A3A10K11R21  |
| 1328 | 2210501765 | E452A3A10K11R22  |
| 1329 | 2210501766 | E452A3A10K11R23  |
| 1330 | 2210501767 | E452A3A10K11R24  |
| 1331 | 2210501768 | E452A3A10K11R25  |
| 1332 | 2210501769 | E452A3A10K11R2A  |
| 1333 | 2210501770 | E452A3A10K11R2B  |
| 1334 | 2210501771 | E452A3A10K11R2C  |
| 1335 | 2210501772 | E452A3A10K11R2D  |
| 1336 | 2210501773 | E452A3A10K11R2E  |
| 1337 | 2210501774 | E452A3A10K11R2G  |
| 1338 | 2210501775 | E452A3A10K11R2H  |
| 1339 | 2210501776 | E452A3A10K11R2K  |
| 1340 | 2210501777 | E452A3A10K11R2L  |
| 1341 | 2210501778 | E452A3A10K11R2M  |
| 1342 | 2210501779 | E452A3A10K11S01  |
| 1343 | 2210501780 | E452A3A10K11S02  |
| 1344 | 2210501781 | E452A3A10K11S03  |
| 1345 | 2210501782 | E452A3A10K11S04  |
| 1346 | 2210501783 | E452A3A10K11S05  |
| 1347 | 2210501784 | E452A3A10K11S0A  |
| 1348 | 2210501785 | E452A3A10K11S0B  |
| 1349 | 2210501786 | E452A3A10K11S0C  |
| 1350 | 2210501787 | E452A3A10K11S0D  |
| 1351 | 2210501788 | E452A3A10K11S0E  |
| 1352 | 2210501789 | E452A3A10K11S0G  |
| 1353 | 2210501790 | E452A3A10K11S0K  |
| 1354 | 2210501791 | E452A3A10K11S0L  |
| 1355 | 2210501792 | E452A3A10K11S0M  |
| 1356 | 2210501793 | E452A3A15011000  |
| 1357 | 2210501794 | E452A3A15011A11  |
| 1358 | 2210501795 | E452A3A15011A12  |
| 1359 | 2210501796 | E452A3A15011A13  |
| 1360 | 2210501797 | E452A3A15011A14  |

| Pos. | Molex PN:  | Engineering No.: |
|------|------------|------------------|
| 1361 | 2210501798 | E452A3A15011A15  |
| 1362 | 2210501799 | E452A3A15011A1A  |
| 1363 | 2210501800 | E452A3A15011A1B  |
| 1364 | 2210501801 | E452A3A15011A1C  |
| 1365 | 2210501802 | E452A3A15011A1D  |
| 1366 | 2210501803 | E452A3A15011A1E  |
| 1367 | 2210501804 | E452A3A15011A1G  |
| 1368 | 2210501805 | E452A3A15011A1H  |
| 1369 | 2210501806 | E452A3A15011A1K  |
| 1370 | 2210501807 | E452A3A15011A1L  |
| 1371 | 2210501808 | E452A3A15011A1M  |
| 1372 | 2210501809 | E452A3A15011C31  |
| 1373 | 2210501810 | E452A3A15011C32  |
| 1374 | 2210501811 | E452A3A15011C33  |
| 1375 | 2210501812 | E452A3A15011C34  |
| 1376 | 2210501813 | E452A3A15011C35  |
| 1377 | 2210501814 | E452A3A15011C3A  |
| 1378 | 2210501815 | E452A3A15011C3B  |
| 1379 | 2210501816 | E452A3A15011C3C  |
| 1380 | 2210501817 | E452A3A15011C3D  |
| 1381 | 2210501818 | E452A3A15011C3E  |
| 1382 | 2210501819 | E452A3A15011C3G  |
| 1383 | 2210501820 | E452A3A15011C3H  |
| 1384 | 2210501821 | E452A3A15011C3K  |
| 1385 | 2210501822 | E452A3A15011C3L  |
| 1386 | 2210501823 | E452A3A15011C3M  |
| 1387 | 2210501824 | E452A3A15011C41  |
| 1388 | 2210501825 | E452A3A15011C42  |
| 1389 | 2210501826 | E452A3A15011C43  |
| 1390 | 2210501827 | E452A3A15011C44  |
| 1391 | 2210501828 | E452A3A15011C45  |
| 1392 | 2210501829 | E452A3A15011C4A  |
| 1393 | 2210501830 | E452A3A15011C4B  |
| 1394 | 2210501831 | E452A3A15011C4C  |
| 1395 | 2210501832 | E452A3A15011C4D  |
| 1396 | 2210501833 | E452A3A15011C4E  |
| 1397 | 2210501834 | E452A3A15011C4G  |
| 1398 | 2210501835 | E452A3A15011C4H  |
| 1399 | 2210501836 | E452A3A15011C4K  |
| 1400 | 2210501837 | E452A3A15011C4L  |

| Pos. | Molex PN:  | Engineering No.: |
|------|------------|------------------|
| 1401 | 2210501838 | E452A3A15011C4M  |
| 1402 | 2210501843 | E452A3A15011E05  |
| 1403 | N/A        | N/A              |
| 1404 | N/A        | N/A              |
| 1405 | N/A        | N/A              |
| 1406 | N/A        | N/A              |
| 1407 | 2210501858 | E452A3A15011R05  |
| 1408 | N/A        | N/A              |
| 1409 | N/A        | N/A              |
| 1410 | N/A        | N/A              |
| 1411 | N/A        | N/A              |
| 1412 | N/A        | N/A              |
| 1413 | N/A        | N/A              |
| 1414 | N/A        | N/A              |
| 1415 | N/A        | N/A              |
| 1416 | N/A        | N/A              |
| 1417 | N/A        | N/A              |
| 1418 | 2210501869 | E452A3A15011R21  |
| 1419 | 2210501870 | E452A3A15011R22  |
| 1420 | 2210501871 | E452A3A15011R23  |
| 1421 | 2210501872 | E452A3A15011R24  |
| 1422 | 2210501873 | E452A3A15011R25  |
| 1423 | 2210501874 | E452A3A15011R2A  |
| 1424 | 2210501875 | E452A3A15011R2B  |
| 1425 | 2210501876 | E452A3A15011R2C  |
| 1426 | 2210501877 | E452A3A15011R2D  |
| 1427 | 2210501878 | E452A3A15011R2E  |
| 1428 | 2210501879 | E452A3A15011R2G  |
| 1429 | 2210501880 | E452A3A15011R2H  |
| 1430 | 2210501881 | E452A3A15011R2K  |
| 1431 | 2210501882 | E452A3A15011R2L  |
| 1432 | 2210501883 | E452A3A15011R2M  |
| 1433 | 2210501884 | E452A3A15011S01  |
| 1434 | 2210501885 | E452A3A15011S02  |
| 1435 | 2210501886 | E452A3A15011S03  |
| 1436 | 2210501887 | E452A3A15011S04  |
| 1437 | 2210501888 | E452A3A15011S05  |
| 1438 | 2210501889 | E452A3A15011S0A  |
| 1439 | 2210501890 | E452A3A15011S0B  |
| 1440 | 2210501891 | E452A3A15011S0C  |

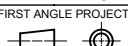
| Pos. | Molex PN:  | Engineering No.: |
|------|------------|------------------|
| 1441 | 2210501892 | E452A3A15011S0D  |
| 1442 | 2210501893 | E452A3A15011S0E  |
| 1443 | 2210501894 | E452A3A15011S0G  |
| 1444 | 2210501895 | E452A3A15011S0K  |
| 1445 | 2210501896 | E452A3A15011S0L  |
| 1446 | 2210501897 | E452A3A15011S0M  |
| 1447 | 2210501898 | E452A3A20011000  |
| 1448 | 2210501899 | E452A3A20011A11  |
| 1449 | 2210501900 | E452A3A20011A12  |
| 1450 | 2210501901 | E452A3A20011A13  |
| 1451 | 2210501902 | E452A3A20011A14  |
| 1452 | 2210501903 | E452A3A20011A15  |
| 1453 | 2210501904 | E452A3A20011A1A  |
| 1454 | 2210501905 | E452A3A20011A1B  |
| 1455 | 2210501906 | E452A3A20011A1C  |
| 1456 | 2210501907 | E452A3A20011A1D  |
| 1457 | 2210501908 | E452A3A20011A1E  |
| 1458 | 2210501909 | E452A3A20011A1G  |
| 1459 | 2210501910 | E452A3A20011A1H  |
| 1460 | 2210501911 | E452A3A20011A1K  |
| 1461 | 2210501912 | E452A3A20011A1L  |
| 1462 | 2210501913 | E452A3A20011C31  |
| 1463 | 2210501914 | E452A3A20011C32  |
| 1464 | 2210501915 | E452A3A20011C33  |
| 1465 | 2210501916 | E452A3A20011C34  |
| 1466 | 2210501917 | E452A3A20011C35  |
| 1467 | 2210501918 | E452A3A20011C3A  |
| 1468 | 2210501919 | E452A3A20011C3B  |
| 1469 | 2210501920 | E452A3A20011C3C  |
| 1470 | 2210501921 | E452A3A20011C3D  |
| 1471 | 2210501922 | E452A3A20011C3E  |
| 1472 | 2210501923 | E452A3A20011C3G  |
| 1473 | 2210501924 | E452A3A20011C3H  |
| 1474 | 2210501925 | E452A3A20011C3K  |
| 1475 | 2210501926 | E452A3A20011C3L  |
| 1476 | 2210501927 | E452A3A20011C3M  |
| 1477 | 2210501928 | E452A3A20011C41  |
| 1478 | 2210501929 | E452A3A20011C43  |
| 1479 | 2210501930 | E452A3A20011C4A  |
| 1480 | 2210501931 | E452A3A20011C4B  |

|   |  |          |  |   |  |              |  |   |  |
|---|--|----------|--|---|--|--------------|--|---|--|
| THIS DRAWING CONTAINS INFORMATION THAT IS PROPRIETARY TO MOLEX ELECTRONIC TECHNOLOGIES, LLC AND SHOULD NOT BE USED WITHOUT WRITTEN PERMISSION |  |          |  |   |  |              |  |   |  |
| DIMENSION UNITS   |  | SCALE    |  | CURRENT REV DESC: REVISION CREATED FOR REMOVING PRE-RELEASE STAMP                     |  |              |  | <br>E452XXXXXXXXXX<br>DIN FORM A EN 175301-803 |  |
| mm  |  | NTS      |  |   |  |              |  |   |  |
| GENERAL TOLERANCES (UNLESS SPECIFIED)   |  |          |  |   |  |              |  |   |  |
|   |  | MM       |  | INCH  |  |              |  |   |  |
| 4 PLACES  |  | ±        |  | ±   |  |              |  |   |  |
| 3 PLACES  |  | ±        |  | ±   |  |              |  |   |  |
| 2 PLACES  |  | ±        |  | ±   |  |              |  |   |  |
| 1 PLACE   |  | ±        |  | ±   |  |              |  |   |  |
| 0 PLACES  |  | ±        |  | ±   |  |              |  |   |  |
| ANGULAR TOL   |  | ± °      |  |   |  |              |  |   |  |
| DRAFT WHERE APPLICABLE MUST REMAIN WITHIN DIMENSIONS  |  |          |  | FIRST ANGLE PROJECTION  |  | DRAWING      |  | SERIES  |  |
|   |  |          |  |  |  | A3-SIZE      |  | 121050  |  |
| DOCUMENT STATUS   |  |          |  | P1  |  | RELEASE DATE |  | 2022/07/19 09:04:35   |  |
| DOCUMENT NUMBER   |  | DOC TYPE |  | DOC PART  |  | REVISION     |  |   |  |
| SD-121050-001   |  | PSD      |  | 001   |  | E1           |  |   |  |
| MATERIAL NUMBER   |  |          |  | CUSTOMER  |  | SHEET NUMBER |  |   |  |
| SEE TABLE   |  |          |  | GENERAL MARKET  |  | 12 OF 41     |  |   |  |



TABLE 3 - PART LIST

| Pos. | Molex PN:  | Engineering No.: |
|------|------------|------------------|
| 1481 | 2210501932 | E452A3A20011C4C  |
| 1482 | 2210501933 | E452A3A20011C4D  |
| 1483 | 2210501934 | E452A3A20011C4E  |
| 1484 | 2210501935 | E452A3A20011C4G  |
| 1485 | 2210501936 | E452A3A20011C4H  |
| 1486 | 2210501937 | E452A3A20011C4K  |
| 1487 | 2210501938 | E452A3A20011C4L  |
| 1488 | 2210501939 | E452A3A20011C4M  |
| 1489 | 2210501944 | E452A3A20011E05  |
| 1490 | N/A        | N/A              |
| 1491 | N/A        | N/A              |
| 1492 | N/A        | N/A              |
| 1493 | N/A        | N/A              |
| 1494 | 2210501959 | E452A3A20011R05  |
| 1495 | N/A        | N/A              |
| 1496 | N/A        | N/A              |
| 1497 | N/A        | N/A              |
| 1498 | N/A        | N/A              |
| 1499 | N/A        | N/A              |
| 1500 | N/A        | N/A              |
| 1501 | N/A        | N/A              |
| 1502 | N/A        | N/A              |
| 1503 | N/A        | N/A              |
| 1504 | N/A        | N/A              |
| 1505 | 2210501970 | E452A3A20011R21  |
| 1506 | 2210501971 | E452A3A20011R22  |
| 1507 | 2210501972 | E452A3A20011R23  |
| 1508 | 2210501973 | E452A3A20011R24  |
| 1509 | 2210501974 | E452A3A20011R25  |
| 1510 | 2210501975 | E452A3A20011R2A  |
| 1511 | 2210501976 | E452A3A20011R2B  |
| 1512 | 2210501977 | E452A3A20011R2C  |
| 1513 | 2210501978 | E452A3A20011R2D  |
| 1514 | 2210501979 | E452A3A20011R2E  |
| 1515 | 2210501980 | E452A3A20011R2G  |
| 1516 | 2210501981 | E452A3A20011R2H  |
| 1517 | 2210501982 | E452A3A20011R2K  |
| 1518 | 2210501983 | E452A3A20011R2L  |
| 1519 | 2210501984 | E452A3A20011R2M  |
| 1520 | 2210501985 | E452A3A20011S01  |

| Pos. | Molex PN:  | Engineering No.: |
|------|------------|------------------|
| 1521 | 2210501986 | E452A3A20011S02  |
| 1522 | 2210501987 | E452A3A20011S03  |
| 1523 | 2210501988 | E452A3A20011S04  |
| 1524 | 2210501989 | E452A3A20011S05  |
| 1525 | 2210501990 | E452A3A20011S0A  |
| 1526 | 2210501991 | E452A3A20011S0B  |
| 1527 | 2210501992 | E452A3A20011S0C  |
| 1528 | 2210501993 | E452A3A20011S0D  |
| 1529 | 2210501994 | E452A3A20011S0E  |
| 1530 | 2210501995 | E452A3A20011S0G  |
| 1531 | 2210501996 | E452A3A20011S0H  |
| 1532 | 2210501997 | E452A3A20011S0K  |
| 1533 | 2210501998 | E452A3A20011S0L  |
| 1534 | 2210501999 | E452A3A20011S0M  |
| 1535 | 2210502000 | E452A3A30011000  |
| 1536 | 2210502001 | E452A3A30011A11  |
| 1537 | 2210502002 | E452A3A30011A12  |
| 1538 | 2210502003 | E452A3A30011A13  |
| 1539 | 2210502004 | E452A3A30011A14  |
| 1540 | 2210502005 | E452A3A30011A15  |
| 1541 | 2210502006 | E452A3A30011A1A  |
| 1542 | 2210502007 | E452A3A30011A1B  |
| 1543 | 2210502008 | E452A3A30011A1C  |
| 1544 | 2210502009 | E452A3A30011A1D  |
| 1545 | 2210502010 | E452A3A30011A1E  |
| 1546 | 2210502011 | E452A3A30011A1G  |
| 1547 | 2210502012 | E452A3A30011A1H  |
| 1548 | 2210502013 | E452A3A30011A1K  |
| 1549 | 2210502014 | E452A3A30011A1L  |
| 1550 | 2210502015 | E452A3A30011A1M  |
| 1551 | 2210502016 | E452A3A30011C31  |
| 1552 | 2210502017 | E452A3A30011C32  |
| 1553 | 2210502018 | E452A3A30011C33  |
| 1554 | 2210502019 | E452A3A30011C34  |
| 1555 | 2210502020 | E452A3A30011C35  |
| 1556 | 2210502021 | E452A3A30011C3A  |
| 1557 | 2210502022 | E452A3A30011C3B  |
| 1558 | 2210502023 | E452A3A30011C3C  |
| 1559 | 2210502024 | E452A3A30011C3D  |
| 1560 | 2210502025 | E452A3A30011C3E  |

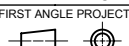
| Pos. | Molex PN:  | Engineering No.: |
|------|------------|------------------|
| 1561 | 2210502026 | E452A3A30011C3G  |
| 1562 | 2210502027 | E452A3A30011C3H  |
| 1563 | 2210502028 | E452A3A30011C3K  |
| 1564 | 2210502029 | E452A3A30011C3L  |
| 1565 | 2210502030 | E452A3A30011C3M  |
| 1566 | 2210502031 | E452A3A30011C41  |
| 1567 | 2210502032 | E452A3A30011C43  |
| 1568 | 2210502033 | E452A3A30011C45  |
| 1569 | 2210502034 | E452A3A30011C4A  |
| 1570 | 2210502035 | E452A3A30011C4B  |
| 1571 | 2210502036 | E452A3A30011C4C  |
| 1572 | 2210502037 | E452A3A30011C4D  |
| 1573 | 2210502038 | E452A3A30011C4E  |
| 1574 | 2210502039 | E452A3A30011C4G  |
| 1575 | 2210502040 | E452A3A30011C4K  |
| 1576 | 2210502041 | E452A3A30011C4M  |
| 1577 | 2210502046 | E452A3A30011E05  |
| 1578 | N/A        | N/A              |
| 1579 | N/A        | N/A              |
| 1580 | N/A        | N/A              |
| 1581 | N/A        | N/A              |
| 1582 | 2210502061 | E452A3A30011R05  |
| 1583 | N/A        | N/A              |
| 1584 | N/A        | N/A              |
| 1585 | N/A        | N/A              |
| 1586 | N/A        | N/A              |
| 1587 | N/A        | N/A              |
| 1588 | N/A        | N/A              |
| 1589 | N/A        | N/A              |
| 1590 | N/A        | N/A              |
| 1591 | N/A        | N/A              |
| 1592 | N/A        | N/A              |
| 1593 | 2210502072 | E452A3A30011R21  |
| 1594 | 2210502073 | E452A3A30011R22  |
| 1595 | 2210502074 | E452A3A30011R23  |
| 1596 | 2210502075 | E452A3A30011R24  |
| 1597 | 2210502076 | E452A3A30011R25  |
| 1598 | 2210502077 | E452A3A30011R2A  |
| 1599 | 2210502078 | E452A3A30011R2B  |
| 1600 | 2210502079 | E452A3A30011R2C  |

| Pos. | Molex PN:  | Engineering No.: |
|------|------------|------------------|
| 1601 | 2210502080 | E452A3A30011R2D  |
| 1602 | 2210502081 | E452A3A30011R2E  |
| 1603 | 2210502082 | E452A3A30011R2G  |
| 1604 | 2210502083 | E452A3A30011R2H  |
| 1605 | 2210502084 | E452A3A30011R2K  |
| 1606 | 2210502085 | E452A3A30011R2M  |
| 1607 | 2210502086 | E452A3A30011S01  |
| 1608 | 2210502087 | E452A3A30011S02  |
| 1609 | 2210502088 | E452A3A30011S03  |
| 1610 | 2210502089 | E452A3A30011S04  |
| 1611 | 2210502090 | E452A3A30011S05  |
| 1612 | 2210502091 | E452A3A30011S0A  |
| 1613 | 2210502092 | E452A3A30011S0B  |
| 1614 | 2210502093 | E452A3A30011S0C  |
| 1615 | 2210502094 | E452A3A30011S0D  |
| 1616 | 2210502095 | E452A3A30011S0E  |
| 1617 | 2210502096 | E452A3A30011S0G  |
| 1618 | 2210502097 | E452A3A30011S0K  |
| 1619 | 2210502098 | E452A3A30011S0L  |
| 1620 | 2210502099 | E452A3A30011S0M  |
| 1621 | 2210502100 | E452A3A50011000  |
| 1622 | 2210502101 | E452A3A50011A11  |
| 1623 | 2210502102 | E452A3A50011A12  |
| 1624 | 2210502103 | E452A3A50011A13  |
| 1625 | 2210502104 | E452A3A50011A14  |
| 1626 | 2210502105 | E452A3A50011A15  |
| 1627 | 2210502106 | E452A3A50011A1A  |
| 1628 | 2210502107 | E452A3A50011A1B  |
| 1629 | 2210502108 | E452A3A50011A1C  |
| 1630 | 2210502109 | E452A3A50011A1D  |
| 1631 | 2210502110 | E452A3A50011A1E  |
| 1632 | 2210502111 | E452A3A50011A1G  |
| 1633 | 2210502112 | E452A3A50011A1H  |
| 1634 | 2210502113 | E452A3A50011A1K  |
| 1635 | 2210502114 | E452A3A50011A1L  |
| 1636 | 2210502115 | E452A3A50011A1M  |
| 1637 | 2210502116 | E452A3A50011C31  |
| 1638 | 2210502117 | E452A3A50011C32  |
| 1639 | 2210502118 | E452A3A50011C33  |
| 1640 | 2210502119 | E452A3A50011C34  |

|   |  |       |  |   |  |  |  |   |  |      |  |
|---|--|-------|--|---|--|--|--|---|--|------|--|
| THIS DRAWING CONTAINS INFORMATION THAT IS PROPRIETARY TO MOLEX ELECTRONIC TECHNOLOGIES, LLC AND SHOULD NOT BE USED WITHOUT WRITTEN PERMISSION |  |       |  |   |  |  |  |   |  |      |  |
| DIMENSION UNITS   |  | SCALE |  | CURRENT REV DESC: REVISION CREATED FOR REMOVING PRE-RELEASE STAMP                         |  |  |  |  |  |      |  |
| mm  |  | NTS   |  |   |  |  |  |   |  |      |  |
| GENERAL TOLERANCES (UNLESS SPECIFIED)   |  |       |  | EC NO: 714567<br>DRWN: SUGEEB 2022/07/18<br>CHK'D: GGA 2022/07/19<br>APPR: GGA 2022/07/19 |  | E452XXXXXXXXXX<br>DIN FORM A EN 175301-803 |  |   |  |      |  |
|   |  | MM    |  |   |  |  |  |   |  | INCH |  |
| 4 PLACES ±  |  | ±     |  |   |  |  |  |   |  | ±    |  |
| 3 PLACES ±  |  | ±     |  |   |  |  |  |   |  | ±    |  |
| 2 PLACES ±  |  | ±     |  |   |  |  |  |   |  | ±    |  |
| 1 PLACE ±   |  | ±     |  | ±   |  |  |  |   |  |      |  |
| 0 PLACES ±  |  | ±     |  | ±   |  |  |  |   |  |      |  |
| ANGULAR TOL ± °   |  |       |  | INITIAL REVISION:   |  | DOCUMENT NUMBER                            |  | DOC TYPE DOC PART REVISION  |  |      |  |
|   |  |       |  | DRWN: JMARSZALEK 2012/08/27   |  | SD-121050-001                              |  | PSD 001 E1  |  |      |  |
|   |  |       |  | APPR: MDYSZEWSKA 2012/08/20   |  |  |  |   |  |      |  |
| DRAFT WHERE APPLICABLE MUST REMAIN WITHIN DIMENSIONS  |  |       |  | FIRST ANGLE PROJECTION  |  | DRAWING                                    |  | SHEET NUMBER  |  |      |  |
|   |  |       |  |      |  | A3-SIZE                                    |  | 121050  |  |      |  |
|   |  |       |  | SERIES  |  | MATERIAL NUMBER                            |  | CUSTOMER  |  |      |  |
|   |  |       |  |   |  | SEE TABLE                                  |  | GENERAL MARKET  |  |      |  |



TABLE 3 - PART LIST

| Pos. | Molex PN:  | Engineering No.: |
|------|------------|------------------|
| 1641 | 2210502120 | E452A3A50011C35  |
| 1642 | 2210502121 | E452A3A50011C3A  |
| 1643 | 2210502122 | E452A3A50011C3B  |
| 1644 | 2210502123 | E452A3A50011C3C  |
| 1645 | 2210502124 | E452A3A50011C3D  |
| 1646 | 2210502125 | E452A3A50011C3E  |
| 1647 | 2210502126 | E452A3A50011C3G  |
| 1648 | 2210502127 | E452A3A50011C3H  |
| 1649 | 2210502128 | E452A3A50011C3K  |
| 1650 | 2210502129 | E452A3A50011C3L  |
| 1651 | 2210502130 | E452A3A50011C3M  |
| 1652 | 2210502131 | E452A3A50011C41  |
| 1653 | 2210502132 | E452A3A50011C42  |
| 1654 | 2210502133 | E452A3A50011C43  |
| 1655 | 2210502134 | E452A3A50011C45  |
| 1656 | 2210502135 | E452A3A50011C4A  |
| 1657 | 2210502136 | E452A3A50011C4B  |
| 1658 | 2210502137 | E452A3A50011C4C  |
| 1659 | 2210502138 | E452A3A50011C4D  |
| 1660 | 2210502139 | E452A3A50011C4E  |
| 1661 | 2210502140 | E452A3A50011C4G  |
| 1662 | 2210502141 | E452A3A50011C4H  |
| 1663 | 2210502142 | E452A3A50011C4K  |
| 1664 | 2210502143 | E452A3A50011C4L  |
| 1665 | 2210502144 | E452A3A50011C4M  |
| 1666 | 2210502149 | E452A3A50011E05  |
| 1667 | N/A        | N/A              |
| 1668 | N/A        | N/A              |
| 1669 | N/A        | N/A              |
| 1670 | N/A        | N/A              |
| 1671 | 2210502164 | E452A3A50011R05  |
| 1672 | N/A        | N/A              |
| 1673 | N/A        | N/A              |
| 1674 | N/A        | N/A              |
| 1675 | N/A        | N/A              |
| 1676 | N/A        | N/A              |
| 1677 | N/A        | N/A              |
| 1678 | N/A        | N/A              |
| 1679 | N/A        | N/A              |
| 1680 | N/A        | N/A              |

| Pos. | Molex PN:  | Engineering No.: |
|------|------------|------------------|
| 1681 | N/A        | N/A              |
| 1682 | 2210502175 | E452A3A50011R21  |
| 1683 | 2210502176 | E452A3A50011R22  |
| 1684 | 2210502177 | E452A3A50011R23  |
| 1685 | 2210502178 | E452A3A50011R24  |
| 1686 | 2210502179 | E452A3A50011R25  |
| 1687 | 2210502180 | E452A3A50011R2A  |
| 1688 | 2210502181 | E452A3A50011R2B  |
| 1689 | 2210502182 | E452A3A50011R2C  |
| 1690 | 2210502183 | E452A3A50011R2D  |
| 1691 | 2210502184 | E452A3A50011R2E  |
| 1692 | 2210502185 | E452A3A50011R2G  |
| 1693 | 2210502186 | E452A3A50011R2H  |
| 1694 | 2210502187 | E452A3A50011R2K  |
| 1695 | 2210502188 | E452A3A50011R2M  |
| 1696 | 2210502189 | E452A3A50011S01  |
| 1697 | 2210502190 | E452A3A50011S02  |
| 1698 | 2210502191 | E452A3A50011S03  |
| 1699 | 2210502192 | E452A3A50011S04  |
| 1700 | 2210502193 | E452A3A50011S05  |
| 1701 | 2210502194 | E452A3A50011S0A  |
| 1702 | 2210502195 | E452A3A50011S0B  |
| 1703 | 2210502196 | E452A3A50011S0C  |
| 1704 | 2210502197 | E452A3A50011S0D  |
| 1705 | 2210502198 | E452A3A50011S0E  |
| 1706 | 2210502199 | E452A3A50011S0G  |
| 1707 | 2210502200 | E452A3A50011S0K  |
| 1708 | 2210502201 | E452A3A50011S0L  |
| 1709 | 2210502202 | E452A3A50011S0M  |
| 1710 | 2210502203 | E452B2A10011000  |
| 1711 | 2210502204 | E452B2A10011A11  |
| 1712 | 2210502205 | E452B2A10011A12  |
| 1713 | 2210502206 | E452B2A10011A13  |
| 1714 | 2210502207 | E452B2A10011A14  |
| 1715 | 2210502208 | E452B2A10011A15  |
| 1716 | 2210502209 | E452B2A10011A1A  |
| 1717 | 2210502210 | E452B2A10011A1B  |
| 1718 | 2210502211 | E452B2A10011A1C  |
| 1719 | 2210502212 | E452B2A10011A1D  |
| 1720 | 2210502213 | E452B2A10011A1E  |

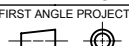
| Pos. | Molex PN:  | Engineering No.: |
|------|------------|------------------|
| 1721 | 2210502214 | E452B2A10011A1G  |
| 1722 | 2210502215 | E452B2A10011A1H  |
| 1723 | 2210502216 | E452B2A10011A1K  |
| 1724 | 2210502217 | E452B2A10011A1L  |
| 1725 | 2210502218 | E452B2A10011A1M  |
| 1726 | 2210502219 | E452B2A10011C31  |
| 1727 | 2210502220 | E452B2A10011C32  |
| 1728 | 2210502221 | E452B2A10011C33  |
| 1729 | 2210502222 | E452B2A10011C34  |
| 1730 | 2210502223 | E452B2A10011C35  |
| 1731 | 2210502224 | E452B2A10011C3A  |
| 1732 | 2210502225 | E452B2A10011C3B  |
| 1733 | 2210502226 | E452B2A10011C3C  |
| 1734 | 2210502227 | E452B2A10011C3D  |
| 1735 | 2210502228 | E452B2A10011C3E  |
| 1736 | 2210502229 | E452B2A10011C3G  |
| 1737 | 2210502230 | E452B2A10011C3H  |
| 1738 | 2210502231 | E452B2A10011C3K  |
| 1739 | 2210502232 | E452B2A10011C3L  |
| 1740 | 2210502233 | E452B2A10011C3M  |
| 1741 | 2210502234 | E452B2A10011C41  |
| 1742 | 2210502235 | E452B2A10011C42  |
| 1743 | 2210502236 | E452B2A10011C43  |
| 1744 | 2210502237 | E452B2A10011C44  |
| 1745 | 2210502238 | E452B2A10011C45  |
| 1746 | 2210502239 | E452B2A10011C4A  |
| 1747 | 2210502240 | E452B2A10011C4B  |
| 1748 | 2210502241 | E452B2A10011C4C  |
| 1749 | 2210502242 | E452B2A10011C4D  |
| 1750 | 2210502243 | E452B2A10011C4E  |
| 1751 | 2210502244 | E452B2A10011C4G  |
| 1752 | 2210502245 | E452B2A10011C4H  |
| 1753 | 2210502246 | E452B2A10011C4K  |
| 1754 | 2210502247 | E452B2A10011C4L  |
| 1755 | 2210502248 | E452B2A10011C4M  |
| 1756 | 2210502253 | E452B2A10011E05  |
| 1757 | N/A        | N/A              |
| 1758 | N/A        | N/A              |
| 1759 | N/A        | N/A              |
| 1760 | N/A        | N/A              |

| Pos. | Molex PN:  | Engineering No.: |
|------|------------|------------------|
| 1761 | 2210502268 | E452B2A10011R05  |
| 1762 | N/A        | N/A              |
| 1763 | N/A        | N/A              |
| 1764 | N/A        | N/A              |
| 1765 | N/A        | N/A              |
| 1766 | N/A        | N/A              |
| 1767 | N/A        | N/A              |
| 1768 | N/A        | N/A              |
| 1769 | N/A        | N/A              |
| 1770 | N/A        | N/A              |
| 1771 | N/A        | N/A              |
| 1772 | 2210502279 | E452B2A10011R21  |
| 1773 | 2210502280 | E452B2A10011R22  |
| 1774 | 2210502281 | E452B2A10011R23  |
| 1775 | 2210502282 | E452B2A10011R24  |
| 1776 | 2210502283 | E452B2A10011R25  |
| 1777 | 2210502284 | E452B2A10011R2A  |
| 1778 | 2210502285 | E452B2A10011R2B  |
| 1779 | 2210502286 | E452B2A10011R2C  |
| 1780 | 2210502287 | E452B2A10011R2D  |
| 1781 | 2210502288 | E452B2A10011R2E  |
| 1782 | 2210502289 | E452B2A10011R2G  |
| 1783 | 2210502290 | E452B2A10011R2H  |
| 1784 | 2210502291 | E452B2A10011R2K  |
| 1785 | 2210502292 | E452B2A10011R2L  |
| 1786 | 2210502293 | E452B2A10011R2M  |
| 1787 | 2210502294 | E452B2A10011S01  |
| 1788 | 2210502295 | E452B2A10011S02  |
| 1789 | 2210502296 | E452B2A10011S03  |
| 1790 | 2210502297 | E452B2A10011S04  |
| 1791 | 2210502298 | E452B2A10011S05  |
| 1792 | 2210502299 | E452B2A10011S0A  |
| 1793 | 2210502300 | E452B2A10011S0B  |
| 1794 | 2210502301 | E452B2A10011S0C  |
| 1795 | 2210502302 | E452B2A10011S0D  |
| 1796 | 2210502303 | E452B2A10011S0E  |
| 1797 | 2210502304 | E452B2A10011S0G  |
| 1798 | 2210502305 | E452B2A10011S0H  |
| 1799 | 2210502306 | E452B2A10011S0K  |
| 1800 | 2210502307 | E452B2A10011S0L  |

|   |  |       |  |  |  |         |  |   |  |                 |  |          |  |          |
|---|--|-------|--|--|--|---------|--|---|--|-----------------|--|----------|--|----------|
| THIS DRAWING CONTAINS INFORMATION THAT IS PROPRIETARY TO MOLEX ELECTRONIC TECHNOLOGIES, LLC AND SHOULD NOT BE USED WITHOUT WRITTEN PERMISSION |  |       |  |  |  |         |  |   |  |                 |  |          |  |          |
| DIMENSION UNITS   |  | SCALE |  | CURRENT REV DESC: REVISION CREATED FOR REMOVING PRE-RELEASE STAMP  |  |         |  | <br>E452XXXXXXXXXX<br>DIN FORM A EN 175301-803 |  |                 |  |          |  |          |
| mm  |  | NTS   |  |  |  |         |  |   |  |                 |  |          |  |          |
| GENERAL TOLERANCES (UNLESS SPECIFIED)   |  |       |  | EC NO: 714567<br>DRWN: SUGEEB 2022/07/18<br>CHK'D: GGA 2022/07/19<br>APPR: GGA 2022/07/19<br>INITIAL REVISION:<br>DRWN: JMARSZALEK 2012/08/27<br>APPR: MDYSZEWSKA 2012/08/20 |  |         |  | PRODUCT CUSTOMER DRAWING  |  |                 |  |          |  |          |
|   |  | MM    |  |  |  |         |  | INCH  |  | DOCUMENT NUMBER |  |          |  |          |
| 4 PLACES ±  |  | ±     |  |  |  |         |  | ±   |  | SD-121050-001   |  |          |  |          |
| 3 PLACES ±  |  | ±     |  |  |  |         |  | ±   |  | DOC TYPE        |  | DOC PART |  | REVISION |
| 2 PLACES ±  |  | ±     |  |  |  |         |  | ±   |  | PSD             |  | 001      |  | E1       |
| 1 PLACE ±   |  | ±     |  |  |  |         |  | ±   |  |                 |  |          |  |          |
| 0 PLACES ±  |  | ±     |  | ±  |  |         |  |   |  |                 |  |          |  |          |
| ANGULAR TOL ± °   |  |       |  | FIRST ANGLE PROJECTION   |  |         |  | DRAWING   |  | SERIES          |  |          |  |          |
| DRAFT WHERE APPLICABLE MUST REMAIN WITHIN DIMENSIONS  |  |       |  |   |  | A3-SIZE |  | 121050  |  | MATERIAL NUMBER |  |          |  |          |
|   |  |       |  |  |  |         |  | CUSTOMER  |  | SHEET NUMBER    |  |          |  |          |
|   |  |       |  |  |  |         |  | SEE TABLE   |  | GENERAL MARKET  |  |          |  |          |
|   |  |       |  |  |  |         |  |   |  | 14 OF 41        |  |          |  |          |

TABLE 3 - PART LIST

| Pos. | Molex PN:  | Engineering No.: |
|------|------------|------------------|
| 1801 | 2210502308 | E452B2A10011S0M  |
| 1802 | 2210502309 | E452B2A10K11000  |
| 1803 | 2210502310 | E452B2A10K11A11  |
| 1804 | 2210502311 | E452B2A10K11A12  |
| 1805 | 2210502312 | E452B2A10K11A13  |
| 1806 | 2210502313 | E452B2A10K11A14  |
| 1807 | 2210502314 | E452B2A10K11A15  |
| 1808 | 2210502315 | E452B2A10K11A1A  |
| 1809 | 2210502316 | E452B2A10K11A1B  |
| 1810 | 2210502317 | E452B2A10K11A1C  |
| 1811 | 2210502318 | E452B2A10K11A1D  |
| 1812 | 2210502319 | E452B2A10K11A1E  |
| 1813 | 2210502320 | E452B2A10K11A1G  |
| 1814 | 2210502321 | E452B2A10K11A1H  |
| 1815 | 2210502322 | E452B2A10K11A1K  |
| 1816 | 2210502323 | E452B2A10K11A1L  |
| 1817 | 2210502324 | E452B2A10K11A1M  |
| 1818 | 2210502325 | E452B2A10K11C31  |
| 1819 | 2210502326 | E452B2A10K11C32  |
| 1820 | 2210502327 | E452B2A10K11C33  |
| 1821 | 2210502328 | E452B2A10K11C34  |
| 1822 | 2210502329 | E452B2A10K11C35  |
| 1823 | 2210502330 | E452B2A10K11C3A  |
| 1824 | 2210502331 | E452B2A10K11C3B  |
| 1825 | 2210502332 | E452B2A10K11C3C  |
| 1826 | 2210502333 | E452B2A10K11C3D  |
| 1827 | 2210502334 | E452B2A10K11C3E  |
| 1828 | 2210502335 | E452B2A10K11C3G  |
| 1829 | 2210502336 | E452B2A10K11C3H  |
| 1830 | 2210502337 | E452B2A10K11C3K  |
| 1831 | 2210502338 | E452B2A10K11C3L  |
| 1832 | 2210502339 | E452B2A10K11C3M  |
| 1833 | 2210502340 | E452B2A10K11C41  |
| 1834 | 2210502341 | E452B2A10K11C42  |
| 1835 | 2210502342 | E452B2A10K11C43  |
| 1836 | 2210502343 | E452B2A10K11C44  |
| 1837 | 2210502344 | E452B2A10K11C45  |
| 1838 | 2210502345 | E452B2A10K11C4A  |
| 1839 | 2210502346 | E452B2A10K11C4B  |
| 1840 | 2210502347 | E452B2A10K11C4C  |

| Pos. | Molex PN:  | Engineering No.: |
|------|------------|------------------|
| 1841 | 2210502348 | E452B2A10K11C4D  |
| 1842 | 2210502349 | E452B2A10K11C4E  |
| 1843 | 2210502350 | E452B2A10K11C4G  |
| 1844 | 2210502351 | E452B2A10K11C4H  |
| 1845 | 2210502352 | E452B2A10K11C4K  |
| 1846 | 2210502353 | E452B2A10K11C4L  |
| 1847 | 2210502354 | E452B2A10K11C4M  |
| 1848 | 2210502359 | E452B2A10K11E05  |
| 1849 | N/A        | N/A              |
| 1850 | N/A        | N/A              |
| 1851 | N/A        | N/A              |
| 1852 | N/A        | N/A              |
| 1853 | 2210502374 | E452B2A10K11R05  |
| 1854 | N/A        | N/A              |
| 1855 | N/A        | N/A              |
| 1856 | N/A        | N/A              |
| 1857 | N/A        | N/A              |
| 1858 | N/A        | N/A              |
| 1859 | N/A        | N/A              |
| 1860 | N/A        | N/A              |
| 1861 | N/A        | N/A              |
| 1862 | N/A        | N/A              |
| 1863 | N/A        | N/A              |
| 1864 | 2210502385 | E452B2A10K11R21  |
| 1865 | 2210502386 | E452B2A10K11R22  |
| 1866 | 2210502387 | E452B2A10K11R23  |
| 1867 | 2210502388 | E452B2A10K11R24  |
| 1868 | 2210502389 | E452B2A10K11R25  |
| 1869 | 2210502390 | E452B2A10K11R2A  |
| 1870 | 2210502391 | E452B2A10K11R2B  |
| 1871 | 2210502392 | E452B2A10K11R2C  |
| 1872 | 2210502393 | E452B2A10K11R2D  |
| 1873 | 2210502394 | E452B2A10K11R2E  |
| 1874 | 2210502395 | E452B2A10K11R2G  |
| 1875 | 2210502396 | E452B2A10K11R2H  |
| 1876 | 2210502397 | E452B2A10K11R2K  |
| 1877 | 2210502398 | E452B2A10K11R2L  |
| 1878 | 2210502399 | E452B2A10K11R2M  |
| 1879 | 2210502400 | E452B2A10K11S01  |
| 1880 | 2210502401 | E452B2A10K11S02  |

| Pos. | Molex PN:  | Engineering No.: |
|------|------------|------------------|
| 1881 | 2210502402 | E452B2A10K11S03  |
| 1882 | 2210502403 | E452B2A10K11S04  |
| 1883 | 2210502404 | E452B2A10K11S05  |
| 1884 | 2210502405 | E452B2A10K11S0A  |
| 1885 | 2210502406 | E452B2A10K11S0B  |
| 1886 | 2210502407 | E452B2A10K11S0C  |
| 1887 | 2210502408 | E452B2A10K11S0D  |
| 1888 | 2210502409 | E452B2A10K11S0E  |
| 1889 | 2210502410 | E452B2A10K11S0G  |
| 1890 | 2210502411 | E452B2A10K11S0H  |
| 1891 | 2210502412 | E452B2A10K11S0K  |
| 1892 | 2210502413 | E452B2A10K11S0L  |
| 1893 | 2210502414 | E452B2A10K11S0M  |
| 1894 | 2210502415 | E452B2A15011000  |
| 1895 | 2210502416 | E452B2A15011A11  |
| 1896 | 2210502417 | E452B2A15011A12  |
| 1897 | 2210502418 | E452B2A15011A13  |
| 1898 | 2210502419 | E452B2A15011A14  |
| 1899 | 2210502420 | E452B2A15011A15  |
| 1900 | 2210502421 | E452B2A15011A1A  |
| 1901 | 2210502422 | E452B2A15011A1B  |
| 1902 | 2210502423 | E452B2A15011A1C  |
| 1903 | 2210502424 | E452B2A15011A1D  |
| 1904 | 2210502425 | E452B2A15011A1E  |
| 1905 | 2210502426 | E452B2A15011A1G  |
| 1906 | 2210502427 | E452B2A15011A1H  |
| 1907 | 2210502428 | E452B2A15011A1K  |
| 1908 | 2210502429 | E452B2A15011A1L  |
| 1909 | 2210502430 | E452B2A15011A1M  |
| 1910 | 2210502431 | E452B2A15011C31  |
| 1911 | 2210502432 | E452B2A15011C32  |
| 1912 | 2210502433 | E452B2A15011C33  |
| 1913 | 2210502434 | E452B2A15011C34  |
| 1914 | 2210502435 | E452B2A15011C35  |
| 1915 | 2210502436 | E452B2A15011C3A  |
| 1916 | 2210502437 | E452B2A15011C3B  |
| 1917 | 2210502438 | E452B2A15011C3C  |
| 1918 | 2210502439 | E452B2A15011C3D  |
| 1919 | 2210502440 | E452B2A15011C3E  |
| 1920 | 2210502441 | E452B2A15011C3G  |

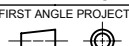
| Pos. | Molex PN:  | Engineering No.: |
|------|------------|------------------|
| 1921 | 2210502442 | E452B2A15011C3H  |
| 1922 | 2210502443 | E452B2A15011C3K  |
| 1923 | 2210502444 | E452B2A15011C3L  |
| 1924 | 2210502445 | E452B2A15011C3M  |
| 1925 | 2210502446 | E452B2A15011C41  |
| 1926 | 2210502447 | E452B2A15011C42  |
| 1927 | 2210502448 | E452B2A15011C43  |
| 1928 | 2210502449 | E452B2A15011C44  |
| 1929 | 2210502450 | E452B2A15011C45  |
| 1930 | 2210502451 | E452B2A15011C4A  |
| 1931 | 2210502452 | E452B2A15011C4B  |
| 1932 | 2210502453 | E452B2A15011C4C  |
| 1933 | 2210502454 | E452B2A15011C4D  |
| 1934 | 2210502455 | E452B2A15011C4E  |
| 1935 | 2210502456 | E452B2A15011C4G  |
| 1936 | 2210502457 | E452B2A15011C4H  |
| 1937 | 2210502458 | E452B2A15011C4K  |
| 1938 | 2210502459 | E452B2A15011C4L  |
| 1939 | 2210502460 | E452B2A15011C4M  |
| 1940 | 2210502465 | E452B2A15011E05  |
| 1941 | N/A        | N/A              |
| 1942 | N/A        | N/A              |
| 1943 | N/A        | N/A              |
| 1944 | N/A        | N/A              |
| 1945 | 2210502480 | E452B2A15011R05  |
| 1946 | N/A        | N/A              |
| 1947 | N/A        | N/A              |
| 1948 | N/A        | N/A              |
| 1949 | N/A        | N/A              |
| 1950 | N/A        | N/A              |
| 1951 | N/A        | N/A              |
| 1952 | N/A        | N/A              |
| 1953 | N/A        | N/A              |
| 1954 | N/A        | N/A              |
| 1955 | N/A        | N/A              |
| 1956 | 2210502491 | E452B2A15011R21  |
| 1957 | 2210502492 | E452B2A15011R22  |
| 1958 | 2210502493 | E452B2A15011R23  |
| 1959 | 2210502494 | E452B2A15011R24  |
| 1960 | 2210502495 | E452B2A15011R25  |

|                 |    |              |            |          |
|-----------------|----|--------------|------------|----------|
| DOCUMENT STATUS | P1 | RELEASE DATE | 2022/07/19 | 09:04:35 |
|-----------------|----|--------------|------------|----------|



|   |  |       |  |   |  |         |  |                   |  |   |  |
|---|--|-------|--|---|--|---------|--|-------------------|--|---|--|
| THIS DRAWING CONTAINS INFORMATION THAT IS PROPRIETARY TO MOLEX ELECTRONIC TECHNOLOGIES, LLC AND SHOULD NOT BE USED WITHOUT WRITTEN PERMISSION |  |       |  |   |  |         |  |                   |  |   |  |
| DIMENSION UNITS   |  | SCALE |  | CURRENT REV DESC: REVISION CREATED FOR REMOVING PRE-RELEASE STAMP                     |  |         |  |                   |  |  |  |
| mm  |  | NTS   |  |   |  |         |  |                   |  |   |  |
| GENERAL TOLERANCES (UNLESS SPECIFIED)   |  |       |  |   |  |         |  |                   |  |   |  |
|   |  |       |  | MM  |  | INCH    |  |                   |  |   |  |
| 4 PLACES ±  |  |       |  | ±   |  | ±       |  | EC NO: 714567     |  |   |  |
| 3 PLACES ±  |  |       |  | ±   |  | ±       |  | DRWN: SUGEEB      |  | 2022/07/18  |  |
| 2 PLACES ±  |  |       |  | ±   |  | ±       |  | CHK'D: GGA        |  | 2022/07/19  |  |
| 1 PLACE ±   |  |       |  | ±   |  | ±       |  | APPR: GGA         |  | 2022/07/19  |  |
| 0 PLACES ±  |  |       |  | ±   |  | ±       |  | INITIAL REVISION: |  |   |  |
| ANGULAR TOL ± °   |  |       |  | ± °   |  | ± °     |  | DRWN: JMARSZALEK  |  | 2012/08/27  |  |
|   |  |       |  |   |  |         |  | APPR: MDYSZEWSKA  |  | 2012/08/20  |  |
| DRAFT WHERE APPLICABLE MUST REMAIN WITHIN DIMENSIONS  |  |       |  | FIRST ANGLE PROJECTION  |  | DRAWING |  | SERIES            |  | MATERIAL NUMBER   |  |
|   |  |       |  |  |  | A3-SIZE |  | 121050            |  | SEE TABLE   |  |
|   |  |       |  |   |  |         |  | CUSTOMER          |  | SHEET NUMBER  |  |
|   |  |       |  |   |  |         |  | GENERAL MARKET    |  | 15 OF 41  |  |

TABLE 3 - PART LIST

| Pos. | Molex PN:  | Engineering No.: |
|------|------------|------------------|
| 1961 | 2210502496 | E452B2A15011R2A  |
| 1962 | 2210502497 | E452B2A15011R2B  |
| 1963 | 2210502498 | E452B2A15011R2C  |
| 1964 | 2210502499 | E452B2A15011R2D  |
| 1965 | 2210502500 | E452B2A15011R2E  |
| 1966 | 2210502501 | E452B2A15011R2G  |
| 1967 | 2210502502 | E452B2A15011R2H  |
| 1968 | 2210502503 | E452B2A15011R2K  |
| 1969 | 2210502504 | E452B2A15011R2L  |
| 1970 | 2210502505 | E452B2A15011R2M  |
| 1971 | 2210502506 | E452B2A15011S01  |
| 1972 | 2210502507 | E452B2A15011S02  |
| 1973 | 2210502508 | E452B2A15011S03  |
| 1974 | 2210502509 | E452B2A15011S04  |
| 1975 | 2210502510 | E452B2A15011S05  |
| 1976 | 2210502511 | E452B2A15011S0A  |
| 1977 | 2210502512 | E452B2A15011S0B  |
| 1978 | 2210502513 | E452B2A15011S0C  |
| 1979 | 2210502514 | E452B2A15011S0D  |
| 1980 | 2210502515 | E452B2A15011S0E  |
| 1981 | 2210502516 | E452B2A15011S0G  |
| 1982 | 2210502517 | E452B2A15011S0H  |
| 1983 | 2210502518 | E452B2A15011S0K  |
| 1984 | 2210502519 | E452B2A15011S0L  |
| 1985 | 2210502520 | E452B2A15011S0M  |
| 1986 | 2210502521 | E452B2A20011000  |
| 1987 | 2210502522 | E452B2A20011A11  |
| 1988 | 2210502523 | E452B2A20011A12  |
| 1989 | 2210502524 | E452B2A20011A13  |
| 1990 | 2210502525 | E452B2A20011A14  |
| 1991 | 2210502526 | E452B2A20011A15  |
| 1992 | 2210502527 | E452B2A20011A1A  |
| 1993 | 2210502528 | E452B2A20011A1B  |
| 1994 | 2210502529 | E452B2A20011A1C  |
| 1995 | 2210502530 | E452B2A20011A1D  |
| 1996 | 2210502531 | E452B2A20011A1E  |
| 1997 | 2210502532 | E452B2A20011A1G  |
| 1998 | 2210502533 | E452B2A20011A1H  |
| 1999 | 2210502534 | E452B2A20011A1K  |
| 2000 | 2210502535 | E452B2A20011A1L  |

| Pos. | Molex PN:  | Engineering No.: |
|------|------------|------------------|
| 2001 | 2210502536 | E452B2A20011A1M  |
| 2002 | 2210502537 | E452B2A20011C31  |
| 2003 | 2210502538 | E452B2A20011C32  |
| 2004 | 2210502539 | E452B2A20011C33  |
| 2005 | 2210502540 | E452B2A20011C34  |
| 2006 | 2210502541 | E452B2A20011C35  |
| 2007 | 2210502542 | E452B2A20011C3A  |
| 2008 | 2210502543 | E452B2A20011C3B  |
| 2009 | 2210502544 | E452B2A20011C3C  |
| 2010 | 2210502545 | E452B2A20011C3D  |
| 2011 | 2210502546 | E452B2A20011C3E  |
| 2012 | 2210502547 | E452B2A20011C3G  |
| 2013 | 2210502548 | E452B2A20011C3H  |
| 2014 | 2210502549 | E452B2A20011C3K  |
| 2015 | 2210502550 | E452B2A20011C3L  |
| 2016 | 2210502551 | E452B2A20011C3M  |
| 2017 | 2210502552 | E452B2A20011C41  |
| 2018 | 2210502553 | E452B2A20011C42  |
| 2019 | 2210502554 | E452B2A20011C43  |
| 2020 | 2210502555 | E452B2A20011C44  |
| 2021 | 2210502556 | E452B2A20011C45  |
| 2022 | 2210502557 | E452B2A20011C4A  |
| 2023 | 2210502558 | E452B2A20011C4B  |
| 2024 | 2210502559 | E452B2A20011C4C  |
| 2025 | 2210502560 | E452B2A20011C4D  |
| 2026 | 2210502561 | E452B2A20011C4E  |
| 2027 | 2210502562 | E452B2A20011C4G  |
| 2028 | 2210502563 | E452B2A20011C4H  |
| 2029 | 2210502564 | E452B2A20011C4K  |
| 2030 | 2210502565 | E452B2A20011C4L  |
| 2031 | 2210502566 | E452B2A20011C4M  |
| 2032 | 2210502571 | E452B2A20011E05  |
| 2033 | N/A        | N/A              |
| 2034 | N/A        | N/A              |
| 2035 | N/A        | N/A              |
| 2036 | N/A        | N/A              |
| 2037 | 2210502586 | E452B2A20011R05  |
| 2038 | N/A        | N/A              |
| 2039 | N/A        | N/A              |
| 2040 | N/A        | N/A              |

| Pos. | Molex PN:  | Engineering No.: |
|------|------------|------------------|
| 2041 | N/A        | N/A              |
| 2042 | N/A        | N/A              |
| 2043 | N/A        | N/A              |
| 2044 | N/A        | N/A              |
| 2045 | N/A        | N/A              |
| 2046 | N/A        | N/A              |
| 2047 | N/A        | N/A              |
| 2048 | 2210502597 | E452B2A20011R21  |
| 2049 | 2210502598 | E452B2A20011R22  |
| 2050 | 2210502599 | E452B2A20011R23  |
| 2051 | 2210502600 | E452B2A20011R24  |
| 2052 | 2210502601 | E452B2A20011R25  |
| 2053 | 2210502602 | E452B2A20011R2A  |
| 2054 | 2210502603 | E452B2A20011R2B  |
| 2055 | 2210502604 | E452B2A20011R2C  |
| 2056 | 2210502605 | E452B2A20011R2D  |
| 2057 | 2210502606 | E452B2A20011R2E  |
| 2058 | 2210502607 | E452B2A20011R2G  |
| 2059 | 2210502608 | E452B2A20011R2H  |
| 2060 | 2210502609 | E452B2A20011R2K  |
| 2061 | 2210502610 | E452B2A20011R2L  |
| 2062 | 2210502611 | E452B2A20011R2M  |
| 2063 | 2210502612 | E452B2A20011S01  |
| 2064 | 2210502613 | E452B2A20011S02  |
| 2065 | 2210502614 | E452B2A20011S03  |
| 2066 | 2210502615 | E452B2A20011S04  |
| 2067 | 2210502616 | E452B2A20011S05  |
| 2068 | 2210502617 | E452B2A20011S0A  |
| 2069 | 2210502618 | E452B2A20011S0B  |
| 2070 | 2210502619 | E452B2A20011S0C  |
| 2071 | 2210502620 | E452B2A20011S0D  |
| 2072 | 2210502621 | E452B2A20011S0E  |
| 2073 | 2210502622 | E452B2A20011S0G  |
| 2074 | 2210502623 | E452B2A20011S0H  |
| 2075 | 2210502624 | E452B2A20011S0K  |
| 2076 | 2210502625 | E452B2A20011S0L  |
| 2077 | 2210502626 | E452B2A20011S0M  |
| 2078 | 2210502627 | E452B2A30011000  |
| 2079 | 2210502628 | E452B2A30011A11  |
| 2080 | 2210502629 | E452B2A30011A12  |

| Pos. | Molex PN:  | Engineering No.: |
|------|------------|------------------|
| 2081 | 2210502630 | E452B2A30011A13  |
| 2082 | 2210502631 | E452B2A30011A14  |
| 2083 | 2210502632 | E452B2A30011A1A  |
| 2084 | 2210502633 | E452B2A30011A1B  |
| 2085 | 2210502634 | E452B2A30011A1C  |
| 2086 | 2210502635 | E452B2A30011A1D  |
| 2087 | 2210502636 | E452B2A30011A1E  |
| 2088 | 2210502637 | E452B2A30011A1G  |
| 2089 | 2210502638 | E452B2A30011A1H  |
| 2090 | 2210502639 | E452B2A30011A1K  |
| 2091 | 2210502640 | E452B2A30011A1L  |
| 2092 | 2210502641 | E452B2A30011A1M  |
| 2093 | 2210502642 | E452B2A30011C31  |
| 2094 | 2210502643 | E452B2A30011C32  |
| 2095 | 2210502644 | E452B2A30011C33  |
| 2096 | 2210502645 | E452B2A30011C34  |
| 2097 | 2210502646 | E452B2A30011C35  |
| 2098 | 2210502647 | E452B2A30011C3A  |
| 2099 | 2210502648 | E452B2A30011C3B  |
| 2100 | 2210502649 | E452B2A30011C3C  |
| 2101 | 2210502650 | E452B2A30011C3D  |
| 2102 | 2210502651 | E452B2A30011C3E  |
| 2103 | 2210502652 | E452B2A30011C3G  |
| 2104 | 2210502653 | E452B2A30011C3H  |
| 2105 | 2210502654 | E452B2A30011C3K  |
| 2106 | 2210502655 | E452B2A30011C3L  |
| 2107 | 2210502656 | E452B2A30011C3M  |
| 2108 | 2210502657 | E452B2A30011C41  |
| 2109 | 2210502658 | E452B2A30011C42  |
| 2110 | 2210502659 | E452B2A30011C43  |
| 2111 | 2210502660 | E452B2A30011C44  |
| 2112 | 2210502661 | E452B2A30011C45  |
| 2113 | 2210502662 | E452B2A30011C4A  |
| 2114 | 2210502663 | E452B2A30011C4B  |
| 2115 | 2210502664 | E452B2A30011C4C  |
| 2116 | 2210502665 | E452B2A30011C4D  |
| 2117 | 2210502666 | E452B2A30011C4E  |
| 2118 | 2210502667 | E452B2A30011C4G  |
| 2119 | 2210502668 | E452B2A30011C4H  |
| 2120 | 2210502669 | E452B2A30011C4K  |

|   |  |       |  |   |  |         |  |                |  |   |  |
|---|--|-------|--|---|--|---------|--|----------------|--|---|--|
| THIS DRAWING CONTAINS INFORMATION THAT IS PROPRIETARY TO MOLEX ELECTRONIC TECHNOLOGIES, LLC AND SHOULD NOT BE USED WITHOUT WRITTEN PERMISSION |  |       |  |   |  |         |  |                |  |   |  |
| DIMENSION UNITS   |  | SCALE |  | CURRENT REV DESC: REVISION CREATED FOR REMOVING PRE-RELEASE STAMP                     |  |         |  |                |  | <br>E452XXXXXXXXXX<br>DIN FORM A EN 175301-803 |  |
| mm  |  | NTS   |  |   |  |         |  |                |  |   |  |
| GENERAL TOLERANCES (UNLESS SPECIFIED)   |  |       |  |   |  |         |  |                |  |   |  |
|   |  | MM    |  | INCH  |  |         |  |                |  |   |  |
| 4 PLACES  |  | ±     |  | ±   |  |         |  |                |  |   |  |
| 3 PLACES  |  | ±     |  | ±   |  |         |  |                |  |   |  |
| 2 PLACES  |  | ±     |  | ±   |  |         |  |                |  |   |  |
| 1 PLACE   |  | ±     |  | ±   |  |         |  |                |  |   |  |
| 0 PLACES  |  | ±     |  | ±   |  |         |  |                |  |   |  |
| ANGULAR TOL   |  | ±     |  | °   |  |         |  |                |  |   |  |
| DRAFT WHERE APPLICABLE MUST REMAIN WITHIN DIMENSIONS  |  |       |  | FIRST ANGLE PROJECTION  |  | DRAWING |  | SERIES         |  | MATERIAL NUMBER   |  |
|   |  |       |  |  |  | A3-SIZE |  | 121050         |  | SEE TABLE   |  |
|   |  |       |  |   |  |         |  | CUSTOMER       |  | SHEET NUMBER  |  |
|   |  |       |  |   |  |         |  | GENERAL MARKET |  | 16 OF 41  |  |

TABLE 3 - PART LIST

| Pos. | Molex PN:  | Engineering No.: |
|------|------------|------------------|
| 2121 | 2210502670 | E452B2A30011C4L  |
| 2122 | 2210502671 | E452B2A30011C4M  |
| 2123 | 2210502676 | E452B2A30011E05  |
| 2124 | N/A        | N/A              |
| 2125 | N/A        | N/A              |
| 2126 | N/A        | N/A              |
| 2127 | N/A        | N/A              |
| 2128 | 2210502691 | E452B2A30011R05  |
| 2129 | N/A        | N/A              |
| 2130 | N/A        | N/A              |
| 2131 | N/A        | N/A              |
| 2132 | N/A        | N/A              |
| 2133 | N/A        | N/A              |
| 2134 | N/A        | N/A              |
| 2135 | N/A        | N/A              |
| 2136 | N/A        | N/A              |
| 2137 | N/A        | N/A              |
| 2138 | N/A        | N/A              |
| 2139 | 2210502702 | E452B2A30011R21  |
| 2140 | 2210502703 | E452B2A30011R22  |
| 2141 | 2210502704 | E452B2A30011R23  |
| 2142 | 2210502705 | E452B2A30011R24  |
| 2143 | 2210502706 | E452B2A30011R25  |
| 2144 | 2210502707 | E452B2A30011R2A  |
| 2145 | 2210502708 | E452B2A30011R2B  |
| 2146 | 2210502709 | E452B2A30011R2C  |
| 2147 | 2210502710 | E452B2A30011R2D  |
| 2148 | 2210502711 | E452B2A30011R2E  |
| 2149 | 2210502712 | E452B2A30011R2G  |
| 2150 | 2210502713 | E452B2A30011R2H  |
| 2151 | 2210502714 | E452B2A30011R2K  |
| 2152 | 2210502715 | E452B2A30011R2L  |
| 2153 | 2210502716 | E452B2A30011R2M  |
| 2154 | 2210502717 | E452B2A30011S01  |
| 2155 | 2210502718 | E452B2A30011S02  |
| 2156 | 2210502719 | E452B2A30011S03  |
| 2157 | 2210502720 | E452B2A30011S04  |
| 2158 | 2210502721 | E452B2A30011S05  |
| 2159 | 2210502722 | E452B2A30011S0A  |
| 2160 | 2210502723 | E452B2A30011S0B  |

| Pos. | Molex PN:  | Engineering No.: |
|------|------------|------------------|
| 2161 | 2210502724 | E452B2A30011S0C  |
| 2162 | 2210502725 | E452B2A30011S0D  |
| 2163 | 2210502726 | E452B2A30011S0E  |
| 2164 | 2210502727 | E452B2A30011S0G  |
| 2165 | 2210502728 | E452B2A30011S0H  |
| 2166 | 2210502729 | E452B2A30011S0K  |
| 2167 | 2210502730 | E452B2A30011S0L  |
| 2168 | 2210502731 | E452B2A30011S0M  |
| 2169 | 2210502732 | E452B2A50011000  |
| 2170 | 2210502733 | E452B2A50011A11  |
| 2171 | 2210502734 | E452B2A50011A12  |
| 2172 | 2210502735 | E452B2A50011A13  |
| 2173 | 2210502736 | E452B2A50011A14  |
| 2174 | 2210502737 | E452B2A50011A15  |
| 2175 | 2210502738 | E452B2A50011A1A  |
| 2176 | 2210502739 | E452B2A50011A1B  |
| 2177 | 2210502740 | E452B2A50011A1C  |
| 2178 | 2210502741 | E452B2A50011A1D  |
| 2179 | 2210502742 | E452B2A50011A1E  |
| 2180 | 2210502743 | E452B2A50011A1G  |
| 2181 | 2210502744 | E452B2A50011A1H  |
| 2182 | 2210502745 | E452B2A50011A1K  |
| 2183 | 2210502746 | E452B2A50011A1L  |
| 2184 | 2210502747 | E452B2A50011A1M  |
| 2185 | 2210502748 | E452B2A50011C31  |
| 2186 | 2210502749 | E452B2A50011C32  |
| 2187 | 2210502750 | E452B2A50011C33  |
| 2188 | 2210502751 | E452B2A50011C34  |
| 2189 | 2210502752 | E452B2A50011C35  |
| 2190 | 2210502753 | E452B2A50011C3A  |
| 2191 | 2210502754 | E452B2A50011C3B  |
| 2192 | 2210502755 | E452B2A50011C3C  |
| 2193 | 2210502756 | E452B2A50011C3D  |
| 2194 | 2210502757 | E452B2A50011C3E  |
| 2195 | 2210502758 | E452B2A50011C3G  |
| 2196 | 2210502759 | E452B2A50011C3H  |
| 2197 | 2210502760 | E452B2A50011C3K  |
| 2198 | 2210502761 | E452B2A50011C3L  |
| 2199 | 2210502762 | E452B2A50011C3M  |
| 2200 | 2210502763 | E452B2A50011C41  |

| Pos. | Molex PN:  | Engineering No.: |
|------|------------|------------------|
| 2201 | 2210502764 | E452B2A50011C42  |
| 2202 | 2210502765 | E452B2A50011C43  |
| 2203 | 2210502766 | E452B2A50011C44  |
| 2204 | 2210502767 | E452B2A50011C45  |
| 2205 | 2210502768 | E452B2A50011C4A  |
| 2206 | 2210502769 | E452B2A50011C4B  |
| 2207 | 2210502770 | E452B2A50011C4C  |
| 2208 | 2210502771 | E452B2A50011C4D  |
| 2209 | 2210502772 | E452B2A50011C4E  |
| 2210 | 2210502773 | E452B2A50011C4G  |
| 2211 | 2210502774 | E452B2A50011C4K  |
| 2212 | 2210502775 | E452B2A50011C4L  |
| 2213 | 2210502776 | E452B2A50011C4M  |
| 2214 | 2210502781 | E452B2A50011E05  |
| 2215 | N/A        | N/A              |
| 2216 | N/A        | N/A              |
| 2217 | N/A        | N/A              |
| 2218 | N/A        | N/A              |
| 2219 | 2210502796 | E452B2A50011R05  |
| 2220 | N/A        | N/A              |
| 2221 | N/A        | N/A              |
| 2222 | N/A        | N/A              |
| 2223 | N/A        | N/A              |
| 2224 | N/A        | N/A              |
| 2225 | N/A        | N/A              |
| 2226 | N/A        | N/A              |
| 2227 | N/A        | N/A              |
| 2228 | N/A        | N/A              |
| 2229 | N/A        | N/A              |
| 2230 | 2210502807 | E452B2A50011R21  |
| 2231 | 2210502808 | E452B2A50011R22  |
| 2232 | 2210502809 | E452B2A50011R23  |
| 2233 | 2210502810 | E452B2A50011R24  |
| 2234 | 2210502811 | E452B2A50011R25  |
| 2235 | 2210502812 | E452B2A50011R2A  |
| 2236 | 2210502813 | E452B2A50011R2B  |
| 2237 | 2210502814 | E452B2A50011R2C  |
| 2238 | 2210502815 | E452B2A50011R2D  |
| 2239 | 2210502816 | E452B2A50011R2E  |
| 2240 | 2210502817 | E452B2A50011R2G  |

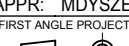
| Pos. | Molex PN:  | Engineering No.: |
|------|------------|------------------|
| 2241 | 2210502818 | E452B2A50011R2H  |
| 2242 | 2210502819 | E452B2A50011R2K  |
| 2243 | 2210502820 | E452B2A50011R2L  |
| 2244 | 2210502821 | E452B2A50011R2M  |
| 2245 | 2210502822 | E452B2A50011S01  |
| 2246 | 2210502823 | E452B2A50011S02  |
| 2247 | 2210502824 | E452B2A50011S03  |
| 2248 | 2210502825 | E452B2A50011S04  |
| 2249 | 2210502826 | E452B2A50011S05  |
| 2250 | 2210502827 | E452B2A50011S0A  |
| 2251 | 2210502828 | E452B2A50011S0B  |
| 2252 | 2210502829 | E452B2A50011S0C  |
| 2253 | 2210502830 | E452B2A50011S0D  |
| 2254 | 2210502831 | E452B2A50011S0E  |
| 2255 | 2210502832 | E452B2A50011S0G  |
| 2256 | 2210502833 | E452B2A50011S0H  |
| 2257 | 2210502834 | E452B2A50011S0K  |
| 2258 | 2210502835 | E452B2A50011S0L  |
| 2259 | 2210502836 | E452B2A50011S0M  |
| 2260 | 2210502837 | E452B3A10011000  |
| 2261 | 2210502838 | E452B3A10011A11  |
| 2262 | 2210502839 | E452B3A10011A12  |
| 2263 | 2210502840 | E452B3A10011A13  |
| 2264 | 2210502841 | E452B3A10011A14  |
| 2265 | 2210502842 | E452B3A10011A15  |
| 2266 | 2210502843 | E452B3A10011A1A  |
| 2267 | 2210502844 | E452B3A10011A1B  |
| 2268 | 2210502845 | E452B3A10011A1C  |
| 2269 | 2210502846 | E452B3A10011A1D  |
| 2270 | 2210502847 | E452B3A10011A1E  |
| 2271 | 2210502848 | E452B3A10011A1G  |
| 2272 | 2210502849 | E452B3A10011A1H  |
| 2273 | 2210502850 | E452B3A10011A1K  |
| 2274 | 2210502851 | E452B3A10011A1L  |
| 2275 | 2210502852 | E452B3A10011A1M  |
| 2276 | 2210502853 | E452B3A10011C31  |
| 2277 | 2210502854 | E452B3A10011C32  |
| 2278 | 2210502855 | E452B3A10011C33  |
| 2279 | 2210502856 | E452B3A10011C34  |
| 2280 | 2210502857 | E452B3A10011C35  |

|   |  |       |  |   |  |                        |  |   |  |
|---|--|-------|--|---|--|------------------------|--|---|--|
| THIS DRAWING CONTAINS INFORMATION THAT IS PROPRIETARY TO MOLEX ELECTRONIC TECHNOLOGIES, LLC AND SHOULD NOT BE USED WITHOUT WRITTEN PERMISSION |  |       |  |   |  |                        |  |   |  |
| DIMENSION UNITS   |  | SCALE |  | CURRENT REV DESC: REVISION CREATED FOR REMOVING PRE-RELEASE STAMP |  |                        |  | <br>E452XXXXXXXXXX<br>DIN FORM A EN 175301-803 |  |
| mm  |  | NTS   |  |   |  |                        |  |   |  |
| GENERAL TOLERANCES (UNLESS SPECIFIED)   |  |       |  | EC NO: 714567   |  | 2022/07/18             |  | PRODUCT CUSTOMER DRAWING  |  |
|   |  |       |  | DRWN: SUGEEB  |  | 2022/07/19             |  |   |  |
|   |  |       |  | CHK'D: GGA  |  | 2022/07/19             |  | DOCUMENT NUMBER   |  |
|   |  |       |  | APPR: GGA   |  | 2022/07/19             |  |   |  |
|   |  |       |  | INITIAL REVISION:   |  |                        |  | SD-121050-001   |  |
|   |  |       |  | DRWN: JMARSZALEK  |  | 2012/08/27             |  |   |  |
|   |  |       |  | APPR: MDYSZEWSKA  |  | 2012/08/20             |  | DOC TYPE  |  |
|   |  |       |  | ANGULAR TOL   |  |                        |  | DOC PART  |  |
|   |  |       |  | DRAFT WHERE APPLICABLE MUST REMAIN WITHIN DIMENSIONS              |  | FIRST ANGLE PROJECTION |  | REVISION  |  |
|   |  |       |  |   |  | DRAWING                |  | PSD   |  |
|   |  |       |  |   |  | SERIES                 |  | 001   |  |
|   |  |       |  |   |  | MATERIAL NUMBER        |  | E1  |  |
|   |  |       |  |   |  | CUSTOMER               |  |   |  |
|   |  |       |  |   |  | SEE TABLE              |  |   |  |
|   |  |       |  |   |  | GENERAL MARKET         |  |   |  |
|   |  |       |  |   |  | SHEET NUMBER           |  | 17 OF 41  |  |

TABLE 3 - PART LIST

| Pos. | Molex PN:  | Engineering No.: |
|------|------------|------------------|
| 2281 | 2210502858 | E452B3A10011C3A  |
| 2282 | 2210502859 | E452B3A10011C3B  |
| 2283 | 2210502860 | E452B3A10011C3C  |
| 2284 | 2210502861 | E452B3A10011C3D  |
| 2285 | 2210502862 | E452B3A10011C3E  |
| 2286 | 2210502863 | E452B3A10011C3G  |
| 2287 | 2210502864 | E452B3A10011C3H  |
| 2288 | 2210502865 | E452B3A10011C3K  |
| 2289 | 2210502866 | E452B3A10011C3L  |
| 2290 | 2210502867 | E452B3A10011C3M  |
| 2291 | 2210502868 | E452B3A10011C41  |
| 2292 | 2210502869 | E452B3A10011C42  |
| 2293 | 2210502870 | E452B3A10011C43  |
| 2294 | 2210502871 | E452B3A10011C44  |
| 2295 | 2210502872 | E452B3A10011C45  |
| 2296 | 2210502873 | E452B3A10011C4A  |
| 2297 | 2210502874 | E452B3A10011C4B  |
| 2298 | 2210502875 | E452B3A10011C4C  |
| 2299 | 2210502876 | E452B3A10011C4D  |
| 2300 | 2210502877 | E452B3A10011C4E  |
| 2301 | 2210502878 | E452B3A10011C4G  |
| 2302 | 2210502879 | E452B3A10011C4H  |
| 2303 | 2210502880 | E452B3A10011C4K  |
| 2304 | 2210502881 | E452B3A10011C4L  |
| 2305 | 2210502882 | E452B3A10011C4M  |
| 2306 | 2210502887 | E452B3A10011E05  |
| 2307 | N/A        | N/A              |
| 2308 | N/A        | N/A              |
| 2309 | N/A        | N/A              |
| 2310 | N/A        | N/A              |
| 2311 | 2210502902 | E452B3A10011R05  |
| 2312 | N/A        | N/A              |
| 2313 | N/A        | N/A              |
| 2314 | N/A        | N/A              |
| 2315 | N/A        | N/A              |
| 2316 | N/A        | N/A              |
| 2317 | N/A        | N/A              |
| 2318 | N/A        | N/A              |
| 2319 | N/A        | N/A              |
| 2320 | N/A        | N/A              |

| Pos. | Molex PN:  | Engineering No.: |
|------|------------|------------------|
| 2321 | N/A        | N/A              |
| 2322 | 2210502913 | E452B3A10011R21  |
| 2323 | 2210502914 | E452B3A10011R22  |
| 2324 | 2210502915 | E452B3A10011R23  |
| 2325 | 2210502916 | E452B3A10011R24  |
| 2326 | 2210502917 | E452B3A10011R25  |
| 2327 | 2210502918 | E452B3A10011R2A  |
| 2328 | 2210502919 | E452B3A10011R2B  |
| 2329 | 2210502920 | E452B3A10011R2C  |
| 2330 | 2210502921 | E452B3A10011R2D  |
| 2331 | 2210502922 | E452B3A10011R2E  |
| 2332 | 2210502923 | E452B3A10011R2G  |
| 2333 | 2210502924 | E452B3A10011R2H  |
| 2334 | 2210502925 | E452B3A10011R2K  |
| 2335 | 2210502926 | E452B3A10011R2L  |
| 2336 | 2210502927 | E452B3A10011R2M  |
| 2337 | 2210502928 | E452B3A10011S01  |
| 2338 | 2210502929 | E452B3A10011S02  |
| 2339 | 2210502930 | E452B3A10011S03  |
| 2340 | 2210502931 | E452B3A10011S04  |
| 2341 | 2210502932 | E452B3A10011S05  |
| 2342 | 2210502933 | E452B3A10011S0A  |
| 2343 | 2210502934 | E452B3A10011S0B  |
| 2344 | 2210502935 | E452B3A10011S0C  |
| 2345 | 2210502936 | E452B3A10011S0D  |
| 2346 | 2210502937 | E452B3A10011S0E  |
| 2347 | 2210502938 | E452B3A10011S0G  |
| 2348 | 2210502939 | E452B3A10011S0H  |
| 2349 | 2210502940 | E452B3A10011S0K  |
| 2350 | 2210502941 | E452B3A10011S0L  |
| 2351 | 2210502942 | E452B3A10011S0M  |
| 2352 | 2210502943 | E452B3A10K11000  |
| 2353 | 2210502944 | E452B3A10K11A11  |
| 2354 | 2210502945 | E452B3A10K11A12  |
| 2355 | 2210502946 | E452B3A10K11A13  |
| 2356 | 2210502947 | E452B3A10K11A14  |
| 2357 | 2210502948 | E452B3A10K11A15  |
| 2358 | 2210502949 | E452B3A10K11A1A  |
| 2359 | 2210502950 | E452B3A10K11A1B  |
| 2360 | 2210502951 | E452B3A10K11A1C  |

| Pos. | Molex PN:  | Engineering No.: |
|------|------------|------------------|
| 2361 | 2210502952 | E452B3A10K11A1D  |
| 2362 | 2210502953 | E452B3A10K11A1E  |
| 2363 | 2210502954 | E452B3A10K11A1G  |
| 2364 | 2210502955 | E452B3A10K11A1H  |
| 2365 | 2210502956 | E452B3A10K11A1K  |
| 2366 | 2210502957 | E452B3A10K11A1L  |
| 2367 | 2210502958 | E452B3A10K11A1M  |
| 2368 | 2210502959 | E452B3A10K11C31  |
| 2369 | 2210502960 | E452B3A10K11C32  |
| 2370 | 2210502961 | E452B3A10K11C33  |
| 2371 | 2210502962 | E452B3A10K11C34  |
| 2372 | 2210502963 | E452B3A10K11C35  |
| 2373 | 2210502964 | E452B3A10K11C3A  |
| 2374 | 2210502965 | E452B3A10K11C3B  |
| 2375 | 2210502966 | E452B3A10K11C3C  |
| 2376 | 2210502967 | E452B3A10K11C3D  |
| 2377 | 2210502968 | E452B3A10K11C3E  |
| 2378 | 2210502969 | E452B3A10K11C3G  |
| 2379 | 2210502970 | E452B3A10K11C3H  |
| 2380 | 2210502971 | E452B3A10K11C3K  |
| 2381 | 2210502972 | E452B3A10K11C3L  |
| 2382 | 2210502973 | E452B3A10K11C3M  |
| 2383 | 2210502974 | E452B3A10K11C41  |
| 2384 | 2210502975 | E452B3A10K11C42  |
| 2385 | 2210502976 | E452B3A10K11C43  |
| 2386 | 2210502977 | E452B3A10K11C44  |
| 2387 | 2210502978 | E452B3A10K11C45  |
| 2388 | 2210502979 | E452B3A10K11C4A  |
| 2389 | 2210502980 | E452B3A10K11C4B  |
| 2390 | 2210502981 | E452B3A10K11C4C  |
| 2391 | 2210502982 | E452B3A10K11C4D  |
| 2392 | 2210502983 | E452B3A10K11C4E  |
| 2393 | 2210502984 | E452B3A10K11C4G  |
| 2394 | 2210502985 | E452B3A10K11C4H  |
| 2395 | 2210502986 | E452B3A10K11C4K  |
| 2396 | 2210502987 | E452B3A10K11C4L  |
| 2397 | 2210502988 | E452B3A10K11C4M  |
| 2398 | 2210502993 | E452B3A10K11E05  |
| 2399 | N/A        | N/A              |
| 2400 | N/A        | N/A              |

| Pos. | Molex PN:  | Engineering No.: |
|------|------------|------------------|
| 2401 | N/A        | N/A              |
| 2402 | N/A        | N/A              |
| 2403 | 2210503008 | E452B3A10K11R05  |
| 2404 | N/A        | N/A              |
| 2405 | N/A        | N/A              |
| 2406 | N/A        | N/A              |
| 2407 | N/A        | N/A              |
| 2408 | N/A        | N/A              |
| 2409 | N/A        | N/A              |
| 2410 | N/A        | N/A              |
| 2411 | N/A        | N/A              |
| 2412 | N/A        | N/A              |
| 2413 | N/A        | N/A              |
| 2414 | 2210503019 | E452B3A10K11R21  |
| 2415 | 2210503020 | E452B3A10K11R22  |
| 2416 | 2210503021 | E452B3A10K11R23  |
| 2417 | 2210503022 | E452B3A10K11R24  |
| 2418 | 2210503023 | E452B3A10K11R25  |
| 2419 | 2210503024 | E452B3A10K11R2A  |
| 2420 | 2210503025 | E452B3A10K11R2B  |
| 2421 | 2210503026 | E452B3A10K11R2C  |
| 2422 | 2210503027 | E452B3A10K11R2D  |
| 2423 | 2210503028 | E452B3A10K11R2E  |
| 2424 | 2210503029 | E452B3A10K11R2G  |
| 2425 | 2210503030 | E452B3A10K11R2H  |
| 2426 | 2210503031 | E452B3A10K11R2K  |
| 2427 | 2210503032 | E452B3A10K11R2L  |
| 2428 | 2210503033 | E452B3A10K11R2M  |
| 2429 | 2210503034 | E452B3A10K11S01  |
| 2430 | 2210503035 | E452B3A10K11S02  |
| 2431 | 2210503036 | E452B3A10K11S03  |
| 2432 | 2210503037 | E452B3A10K11S04  |
| 2433 | 2210503038 | E452B3A10K11S05  |
| 2434 | 2210503039 | E452B3A10K11S0A  |
| 2435 | 2210503040 | E452B3A10K11S0B  |
| 2436 | 2210503041 | E452B3A10K11S0C  |
| 2437 | 2210503042 | E452B3A10K11S0D  |
| 2438 | 2210503043 | E452B3A10K11S0E  |
| 2439 | 2210503044 | E452B3A10K11S0G  |
| 2440 | 2210503045 | E452B3A10K11S0H  |

|   |  |       |  |   |  |                        |  |   |  |
|---|--|-------|--|---|--|------------------------|--|---|--|
| THIS DRAWING CONTAINS INFORMATION THAT IS PROPRIETARY TO MOLEX ELECTRONIC TECHNOLOGIES, LLC AND SHOULD NOT BE USED WITHOUT WRITTEN PERMISSION |  |       |  |   |  |                        |  |   |  |
| DIMENSION UNITS   |  | SCALE |  | CURRENT REV DESC: REVISION CREATED FOR REMOVING PRE-RELEASE STAMP |  |                        |  |  |  |
| mm  |  | NTS   |  |   |  |                        |  |   |  |
| GENERAL TOLERANCES (UNLESS SPECIFIED)   |  |       |  | EC NO: 714567   |  | 2022/07/18             |  | E452XXXXXXXXXX  |  |
|   |  |       |  | DRWN: SUGEEB  |  | 2022/07/19             |  | DIN FORM A EN 175301-803  |  |
|   |  |       |  | CHK'D: GGA  |  | 2022/07/19             |  | PRODUCT CUSTOMER DRAWING  |  |
|   |  |       |  | APPR: GGA   |  | 2022/07/19             |  | DOCUMENT NUMBER   |  |
|   |  |       |  | INITIAL REVISION:   |  |                        |  | SD-121050-001   |  |
|   |  |       |  | DRWN: JMARSZALEK  |  | 2012/08/27             |  | DOC TYPE  |  |
|   |  |       |  | APPR: MDYSZEWSKA  |  | 2012/08/20             |  | PSD   |  |
|   |  |       |  | ANGULAR TOL   |  |                        |  | DOC PART  |  |
|   |  |       |  | DRAFT WHERE APPLICABLE MUST REMAIN WITHIN DIMENSIONS              |  | FIRST ANGLE PROJECTION |  | 001   |  |
|   |  |       |  |   |  | DRAWING                |  | REVISION  |  |
|   |  |       |  |   |  | SERIES                 |  | E1  |  |
|   |  |       |  |   |  | MATERIAL NUMBER        |  | SHEET NUMBER  |  |
|   |  |       |  |   |  | A3-SIZE                |  | 18 OF 41  |  |
|   |  |       |  |   |  | 121050                 |  | GENERAL MARKET  |  |
|   |  |       |  |   |  | SEE TABLE              |  |   |  |

TABLE 3 - PART LIST

| Pos. | Molex PN:  | Engineering No.: |
|------|------------|------------------|
| 2441 | 2210503046 | E452B3A10K11S0K  |
| 2442 | 2210503047 | E452B3A10K11S0L  |
| 2443 | 2210503048 | E452B3A10K11S0M  |
| 2444 | 2210503049 | E452B3A15011000  |
| 2445 | 2210503050 | E452B3A15011A11  |
| 2446 | 2210503051 | E452B3A15011A12  |
| 2447 | 2210503052 | E452B3A15011A13  |
| 2448 | 2210503053 | E452B3A15011A14  |
| 2449 | 2210503054 | E452B3A15011A15  |
| 2450 | 2210503055 | E452B3A15011A1A  |
| 2451 | 2210503056 | E452B3A15011A1B  |
| 2452 | 2210503057 | E452B3A15011A1C  |
| 2453 | 2210503058 | E452B3A15011A1D  |
| 2454 | 2210503059 | E452B3A15011A1E  |
| 2455 | 2210503060 | E452B3A15011A1G  |
| 2456 | 2210503061 | E452B3A15011A1H  |
| 2457 | 2210503062 | E452B3A15011A1K  |
| 2458 | 2210503063 | E452B3A15011A1L  |
| 2459 | 2210503064 | E452B3A15011A1M  |
| 2460 | 2210503065 | E452B3A15011C31  |
| 2461 | 2210503066 | E452B3A15011C32  |
| 2462 | 2210503067 | E452B3A15011C33  |
| 2463 | 2210503068 | E452B3A15011C34  |
| 2464 | 2210503069 | E452B3A15011C35  |
| 2465 | 2210503070 | E452B3A15011C3A  |
| 2466 | 2210503071 | E452B3A15011C3B  |
| 2467 | 2210503072 | E452B3A15011C3C  |
| 2468 | 2210503073 | E452B3A15011C3D  |
| 2469 | 2210503074 | E452B3A15011C3E  |
| 2470 | 2210503075 | E452B3A15011C3G  |
| 2471 | 2210503076 | E452B3A15011C3H  |
| 2472 | 2210503077 | E452B3A15011C3K  |
| 2473 | 2210503078 | E452B3A15011C3L  |
| 2474 | 2210503079 | E452B3A15011C3M  |
| 2475 | 2210503080 | E452B3A15011C41  |
| 2476 | 2210503081 | E452B3A15011C42  |
| 2477 | 2210503082 | E452B3A15011C43  |
| 2478 | 2210503083 | E452B3A15011C44  |
| 2479 | 2210503084 | E452B3A15011C45  |
| 2480 | 2210503085 | E452B3A15011C4A  |

| Pos. | Molex PN:  | Engineering No.: |
|------|------------|------------------|
| 2481 | 2210503086 | E452B3A15011C4B  |
| 2482 | 2210503087 | E452B3A15011C4C  |
| 2483 | 2210503088 | E452B3A15011C4D  |
| 2484 | 2210503089 | E452B3A15011C4E  |
| 2485 | 2210503090 | E452B3A15011C4G  |
| 2486 | 2210503091 | E452B3A15011C4H  |
| 2487 | 2210503092 | E452B3A15011C4K  |
| 2488 | 2210503093 | E452B3A15011C4L  |
| 2489 | 2210503094 | E452B3A15011C4M  |
| 2490 | 2210503099 | E452B3A15011E05  |
| 2491 | N/A        | N/A              |
| 2492 | N/A        | N/A              |
| 2493 | N/A        | N/A              |
| 2494 | N/A        | N/A              |
| 2495 | 2210503114 | E452B3A15011R05  |
| 2496 | N/A        | N/A              |
| 2497 | N/A        | N/A              |
| 2498 | N/A        | N/A              |
| 2499 | N/A        | N/A              |
| 2500 | N/A        | N/A              |
| 2501 | N/A        | N/A              |
| 2502 | N/A        | N/A              |
| 2503 | N/A        | N/A              |
| 2504 | N/A        | N/A              |
| 2505 | N/A        | N/A              |
| 2506 | 2210503125 | E452B3A15011R21  |
| 2507 | 2210503126 | E452B3A15011R22  |
| 2508 | 2210503127 | E452B3A15011R23  |
| 2509 | 2210503128 | E452B3A15011R24  |
| 2510 | 2210503129 | E452B3A15011R25  |
| 2511 | 2210503130 | E452B3A15011R2A  |
| 2512 | 2210503131 | E452B3A15011R2B  |
| 2513 | 2210503132 | E452B3A15011R2C  |
| 2514 | 2210503133 | E452B3A15011R2D  |
| 2515 | 2210503134 | E452B3A15011R2E  |
| 2516 | 2210503135 | E452B3A15011R2G  |
| 2517 | 2210503136 | E452B3A15011R2H  |
| 2518 | 2210503137 | E452B3A15011R2K  |
| 2519 | 2210503138 | E452B3A15011R2L  |
| 2520 | 2210503139 | E452B3A15011R2M  |

| Pos. | Molex PN:  | Engineering No.: |
|------|------------|------------------|
| 2521 | 2210503140 | E452B3A15011S01  |
| 2522 | 2210503141 | E452B3A15011S02  |
| 2523 | 2210503142 | E452B3A15011S03  |
| 2524 | 2210503143 | E452B3A15011S04  |
| 2525 | 2210503144 | E452B3A15011S05  |
| 2526 | 2210503145 | E452B3A15011S0A  |
| 2527 | 2210503146 | E452B3A15011S0B  |
| 2528 | 2210503147 | E452B3A15011S0C  |
| 2529 | 2210503148 | E452B3A15011S0D  |
| 2530 | 2210503149 | E452B3A15011S0E  |
| 2531 | 2210503150 | E452B3A15011S0G  |
| 2532 | 2210503151 | E452B3A15011S0H  |
| 2533 | 2210503152 | E452B3A15011S0K  |
| 2534 | 2210503153 | E452B3A15011S0L  |
| 2535 | 2210503154 | E452B3A15011S0M  |
| 2536 | 2210503155 | E452B3A20011000  |
| 2537 | 2210503156 | E452B3A20011A11  |
| 2538 | 2210503157 | E452B3A20011A12  |
| 2539 | 2210503158 | E452B3A20011A13  |
| 2540 | 2210503159 | E452B3A20011A14  |
| 2541 | 2210503160 | E452B3A20011A15  |
| 2542 | 2210503161 | E452B3A20011A1A  |
| 2543 | 2210503162 | E452B3A20011A1B  |
| 2544 | 2210503163 | E452B3A20011A1C  |
| 2545 | 2210503164 | E452B3A20011A1D  |
| 2546 | 2210503165 | E452B3A20011A1E  |
| 2547 | 2210503166 | E452B3A20011A1G  |
| 2548 | 2210503167 | E452B3A20011A1H  |
| 2549 | 2210503168 | E452B3A20011A1K  |
| 2550 | 2210503169 | E452B3A20011A1L  |
| 2551 | 2210503170 | E452B3A20011A1M  |
| 2552 | 2210503171 | E452B3A20011C31  |
| 2553 | 2210503172 | E452B3A20011C32  |
| 2554 | 2210503173 | E452B3A20011C33  |
| 2555 | 2210503174 | E452B3A20011C34  |
| 2556 | 2210503175 | E452B3A20011C35  |
| 2557 | 2210503176 | E452B3A20011C3A  |
| 2558 | 2210503177 | E452B3A20011C3B  |
| 2559 | 2210503178 | E452B3A20011C3C  |
| 2560 | 2210503179 | E452B3A20011C3D  |

| Pos. | Molex PN:  | Engineering No.: |
|------|------------|------------------|
| 2561 | 2210503180 | E452B3A20011C3E  |
| 2562 | 2210503181 | E452B3A20011C3G  |
| 2563 | 2210503182 | E452B3A20011C3H  |
| 2564 | 2210503183 | E452B3A20011C3K  |
| 2565 | 2210503184 | E452B3A20011C3L  |
| 2566 | 2210503185 | E452B3A20011C3M  |
| 2567 | 2210503186 | E452B3A20011C41  |
| 2568 | 2210503187 | E452B3A20011C42  |
| 2569 | 2210503188 | E452B3A20011C43  |
| 2570 | 2210503189 | E452B3A20011C44  |
| 2571 | 2210503190 | E452B3A20011C45  |
| 2572 | 2210503191 | E452B3A20011C4A  |
| 2573 | 2210503192 | E452B3A20011C4B  |
| 2574 | 2210503193 | E452B3A20011C4C  |
| 2575 | 2210503194 | E452B3A20011C4D  |
| 2576 | 2210503195 | E452B3A20011C4E  |
| 2577 | 2210503196 | E452B3A20011C4G  |
| 2578 | 2210503197 | E452B3A20011C4H  |
| 2579 | 2210503198 | E452B3A20011C4K  |
| 2580 | 2210503199 | E452B3A20011C4L  |
| 2581 | 2210503200 | E452B3A20011C4M  |
| 2582 | 2210503205 | E452B3A20011E05  |
| 2583 | N/A        | N/A              |
| 2584 | N/A        | N/A              |
| 2585 | N/A        | N/A              |
| 2586 | N/A        | N/A              |
| 2587 | 2210503220 | E452B3A20011R05  |
| 2588 | N/A        | N/A              |
| 2589 | N/A        | N/A              |
| 2590 | N/A        | N/A              |
| 2591 | N/A        | N/A              |
| 2592 | N/A        | N/A              |
| 2593 | N/A        | N/A              |
| 2594 | N/A        | N/A              |
| 2595 | N/A        | N/A              |
| 2596 | N/A        | N/A              |
| 2597 | N/A        | N/A              |
| 2598 | 2210503231 | E452B3A20011R21  |
| 2599 | 2210503232 | E452B3A20011R22  |
| 2600 | 2210503233 | E452B3A20011R23  |

|   |  |       |  |   |  |                        |  |   |  |
|---|--|-------|--|---|--|------------------------|--|---|--|
| THIS DRAWING CONTAINS INFORMATION THAT IS PROPRIETARY TO MOLEX ELECTRONIC TECHNOLOGIES, LLC AND SHOULD NOT BE USED WITHOUT WRITTEN PERMISSION |  |       |  |   |  |                        |  |   |  |
| DIMENSION UNITS   |  | SCALE |  | CURRENT REV DESC: REVISION CREATED FOR REMOVING PRE-RELEASE STAMP |  |                        |  | <br>E452XXXXXXXXXX<br>DIN FORM A EN 175301-803 |  |
| mm  |  | NTS   |  |   |  |                        |  |   |  |
| GENERAL TOLERANCES (UNLESS SPECIFIED)   |  |       |  | EC NO: 714567   |  | 2022/07/18             |  | PRODUCT CUSTOMER DRAWING  |  |
|   |  |       |  | DRWN: SUGEEB  |  | 2022/07/19             |  |   |  |
|   |  |       |  | CHK'D: GGA  |  | 2022/07/19             |  | DOCUMENT NUMBER   |  |
|   |  |       |  | APPR: GGA   |  | 2022/07/19             |  |   |  |
|   |  |       |  | INITIAL REVISION:   |  |                        |  | SD-121050-001<br>PSD 001 E1   |  |
|   |  |       |  | DRWN: JMARSZALEK  |  | 2012/08/27             |  |   |  |
|   |  |       |  | APPR: MDYSZEWSKA  |  | 2012/08/20             |  | DOC TYPE  |  |
|   |  |       |  | ANGULAR TOL   |  |                        |  | DOC PART  |  |
|   |  |       |  | DRAFT WHERE APPLICABLE MUST REMAIN WITHIN DIMENSIONS              |  | FIRST ANGLE PROJECTION |  | REVISION  |  |
|   |  |       |  |   |  | DRAWING                |  | SERIES  |  |
|   |  |       |  |   |  | A3-SIZE                |  | MATERIAL NUMBER   |  |
|   |  |       |  |   |  | 121050                 |  | CUSTOMER  |  |
|   |  |       |  |   |  | SEE TABLE              |  | SHEET NUMBER  |  |
|   |  |       |  |   |  | GENERAL MARKET         |  | 19 OF 41  |  |

TABLE 3 - PART LIST

| Pos. | Molex PN:  | Engineering No.: |
|------|------------|------------------|
| 2601 | 2210503234 | E452B3A20011R24  |
| 2602 | 2210503235 | E452B3A20011R25  |
| 2603 | 2210503236 | E452B3A20011R2A  |
| 2604 | 2210503237 | E452B3A20011R2B  |
| 2605 | 2210503238 | E452B3A20011R2C  |
| 2606 | 2210503239 | E452B3A20011R2D  |
| 2607 | 2210503240 | E452B3A20011R2E  |
| 2608 | 2210503241 | E452B3A20011R2G  |
| 2609 | 2210503242 | E452B3A20011R2H  |
| 2610 | 2210503243 | E452B3A20011R2K  |
| 2611 | 2210503244 | E452B3A20011R2L  |
| 2612 | 2210503245 | E452B3A20011R2M  |
| 2613 | 2210503246 | E452B3A20011S01  |
| 2614 | 2210503247 | E452B3A20011S02  |
| 2615 | 2210503248 | E452B3A20011S03  |
| 2616 | 2210503249 | E452B3A20011S04  |
| 2617 | 2210503250 | E452B3A20011S05  |
| 2618 | 2210503251 | E452B3A20011S0A  |
| 2619 | 2210503252 | E452B3A20011S0B  |
| 2620 | 2210503253 | E452B3A20011S0C  |
| 2621 | 2210503254 | E452B3A20011S0D  |
| 2622 | 2210503255 | E452B3A20011S0E  |
| 2623 | 2210503256 | E452B3A20011S0G  |
| 2624 | 2210503257 | E452B3A20011S0H  |
| 2625 | 2210503258 | E452B3A20011S0K  |
| 2626 | 2210503259 | E452B3A20011S0L  |
| 2627 | 2210503260 | E452B3A20011S0M  |
| 2628 | 2210503261 | E452B3A30011000  |
| 2629 | 2210503262 | E452B3A30011A11  |
| 2630 | 2210503263 | E452B3A30011A12  |
| 2631 | 2210503264 | E452B3A30011A13  |
| 2632 | 2210503265 | E452B3A30011A14  |
| 2633 | 2210503266 | E452B3A30011A15  |
| 2634 | 2210503267 | E452B3A30011A1A  |
| 2635 | 2210503268 | E452B3A30011A1B  |
| 2636 | 2210503269 | E452B3A30011A1C  |
| 2637 | 2210503270 | E452B3A30011A1D  |
| 2638 | 2210503271 | E452B3A30011A1E  |
| 2639 | 2210503272 | E452B3A30011A1G  |
| 2640 | 2210503273 | E452B3A30011A1H  |

| Pos. | Molex PN:  | Engineering No.: |
|------|------------|------------------|
| 2641 | 2210503274 | E452B3A30011A1K  |
| 2642 | 2210503275 | E452B3A30011A1L  |
| 2643 | 2210503276 | E452B3A30011A1M  |
| 2644 | 2210503277 | E452B3A30011C31  |
| 2645 | 2210503278 | E452B3A30011C32  |
| 2646 | 2210503279 | E452B3A30011C33  |
| 2647 | 2210503280 | E452B3A30011C34  |
| 2648 | 2210503281 | E452B3A30011C35  |
| 2649 | 2210503282 | E452B3A30011C3A  |
| 2650 | 2210503283 | E452B3A30011C3B  |
| 2651 | 2210503284 | E452B3A30011C3C  |
| 2652 | 2210503285 | E452B3A30011C3D  |
| 2653 | 2210503286 | E452B3A30011C3E  |
| 2654 | 2210503287 | E452B3A30011C3G  |
| 2655 | 2210503288 | E452B3A30011C3H  |
| 2656 | 2210503289 | E452B3A30011C3K  |
| 2657 | 2210503290 | E452B3A30011C3L  |
| 2658 | 2210503291 | E452B3A30011C3M  |
| 2659 | 2210503292 | E452B3A30011C41  |
| 2660 | 2210503293 | E452B3A30011C42  |
| 2661 | 2210503294 | E452B3A30011C43  |
| 2662 | 2210503295 | E452B3A30011C44  |
| 2663 | 2210503296 | E452B3A30011C45  |
| 2664 | 2210503297 | E452B3A30011C4A  |
| 2665 | 2210503298 | E452B3A30011C4B  |
| 2666 | 2210503299 | E452B3A30011C4C  |
| 2667 | 2210503300 | E452B3A30011C4D  |
| 2668 | 2210503301 | E452B3A30011C4E  |
| 2669 | 2210503302 | E452B3A30011C4G  |
| 2670 | 2210503303 | E452B3A30011C4K  |
| 2671 | 2210503304 | E452B3A30011C4L  |
| 2672 | 2210503305 | E452B3A30011C4M  |
| 2673 | 2210503310 | E452B3A30011E05  |
| 2674 | N/A        | N/A              |
| 2675 | N/A        | N/A              |
| 2676 | N/A        | N/A              |
| 2677 | N/A        | N/A              |
| 2678 | 2210503325 | E452B3A30011R05  |
| 2679 | N/A        | N/A              |
| 2680 | N/A        | N/A              |

| Pos. | Molex PN:  | Engineering No.: |
|------|------------|------------------|
| 2681 | N/A        | N/A              |
| 2682 | N/A        | N/A              |
| 2683 | N/A        | N/A              |
| 2684 | N/A        | N/A              |
| 2685 | N/A        | N/A              |
| 2686 | N/A        | N/A              |
| 2687 | N/A        | N/A              |
| 2688 | N/A        | N/A              |
| 2689 | 2210503336 | E452B3A30011R21  |
| 2690 | 2210503337 | E452B3A30011R22  |
| 2691 | 2210503338 | E452B3A30011R23  |
| 2692 | 2210503339 | E452B3A30011R24  |
| 2693 | 2210503340 | E452B3A30011R25  |
| 2694 | 2210503341 | E452B3A30011R2A  |
| 2695 | 2210503342 | E452B3A30011R2B  |
| 2696 | 2210503343 | E452B3A30011R2C  |
| 2697 | 2210503344 | E452B3A30011R2D  |
| 2698 | 2210503345 | E452B3A30011R2E  |
| 2699 | 2210503346 | E452B3A30011R2G  |
| 2700 | 2210503347 | E452B3A30011R2H  |
| 2701 | 2210503348 | E452B3A30011R2K  |
| 2702 | 2210503349 | E452B3A30011R2L  |
| 2703 | 2210503350 | E452B3A30011R2M  |
| 2704 | 2210503351 | E452B3A30011S01  |
| 2705 | 2210503352 | E452B3A30011S02  |
| 2706 | 2210503353 | E452B3A30011S03  |
| 2707 | 2210503354 | E452B3A30011S04  |
| 2708 | 2210503355 | E452B3A30011S05  |
| 2709 | 2210503356 | E452B3A30011S0A  |
| 2710 | 2210503357 | E452B3A30011S0B  |
| 2711 | 2210503358 | E452B3A30011S0C  |
| 2712 | 2210503359 | E452B3A30011S0D  |
| 2713 | 2210503360 | E452B3A30011S0E  |
| 2714 | 2210503361 | E452B3A30011S0G  |
| 2715 | 2210503362 | E452B3A30011S0K  |
| 2716 | 2210503363 | E452B3A30011S0L  |
| 2717 | 2210503364 | E452B3A30011S0M  |
| 2718 | 2210503365 | E452B3A50011000  |
| 2719 | 2210503366 | E452B3A50011A11  |
| 2720 | 2210503367 | E452B3A50011A12  |

| Pos. | Molex PN:  | Engineering No.: |
|------|------------|------------------|
| 2721 | 2210503368 | E452B3A50011A13  |
| 2722 | 2210503369 | E452B3A50011A14  |
| 2723 | 2210503370 | E452B3A50011A15  |
| 2724 | 2210503371 | E452B3A50011A1A  |
| 2725 | 2210503372 | E452B3A50011A1B  |
| 2726 | 2210503373 | E452B3A50011A1C  |
| 2727 | 2210503374 | E452B3A50011A1D  |
| 2728 | 2210503375 | E452B3A50011A1E  |
| 2729 | 2210503376 | E452B3A50011A1G  |
| 2730 | 2210503377 | E452B3A50011A1H  |
| 2731 | 2210503378 | E452B3A50011A1K  |
| 2732 | 2210503379 | E452B3A50011A1L  |
| 2733 | 2210503380 | E452B3A50011A1M  |
| 2734 | 2210503381 | E452B3A50011C31  |
| 2735 | 2210503382 | E452B3A50011C32  |
| 2736 | 2210503383 | E452B3A50011C33  |
| 2737 | 2210503384 | E452B3A50011C34  |
| 2738 | 2210503385 | E452B3A50011C35  |
| 2739 | 2210503386 | E452B3A50011C3A  |
| 2740 | 2210503387 | E452B3A50011C3B  |
| 2741 | 2210503388 | E452B3A50011C3C  |
| 2742 | 2210503389 | E452B3A50011C3D  |
| 2743 | 2210503390 | E452B3A50011C3E  |
| 2744 | 2210503391 | E452B3A50011C3G  |
| 2745 | 2210503392 | E452B3A50011C3H  |
| 2746 | 2210503393 | E452B3A50011C3K  |
| 2747 | 2210503394 | E452B3A50011C3L  |
| 2748 | 2210503395 | E452B3A50011C3M  |
| 2749 | 2210503396 | E452B3A50011C41  |
| 2750 | 2210503397 | E452B3A50011C42  |
| 2751 | 2210503398 | E452B3A50011C43  |
| 2752 | 2210503399 | E452B3A50011C44  |
| 2753 | 2210503400 | E452B3A50011C45  |
| 2754 | 2210503401 | E452B3A50011C4A  |
| 2755 | 2210503402 | E452B3A50011C4B  |
| 2756 | 2210503403 | E452B3A50011C4C  |
| 2757 | 2210503404 | E452B3A50011C4D  |
| 2758 | 2210503405 | E452B3A50011C4E  |
| 2759 | 2210503406 | E452B3A50011C4G  |
| 2760 | 2210503407 | E452B3A50011C4K  |

|   |  |       |  |   |  |                        |  |   |  |
|---|--|-------|--|---|--|------------------------|--|---|--|
| THIS DRAWING CONTAINS INFORMATION THAT IS PROPRIETARY TO MOLEX ELECTRONIC TECHNOLOGIES, LLC AND SHOULD NOT BE USED WITHOUT WRITTEN PERMISSION |  |       |  |   |  |                        |  |   |  |
| DIMENSION UNITS   |  | SCALE |  | CURRENT REV DESC: REVISION CREATED FOR REMOVING PRE-RELEASE STAMP |  |                        |  | <br>E452XXXXXXXXXX<br>DIN FORM A EN 175301-803 |  |
| mm  |  | NTS   |  |   |  |                        |  |   |  |
| GENERAL TOLERANCES (UNLESS SPECIFIED)   |  |       |  | EC NO: 714567   |  | 2022/07/18             |  | PRODUCT CUSTOMER DRAWING  |  |
|   |  |       |  | DRWN: SUGEEB  |  | 2022/07/19             |  |   |  |
|   |  |       |  | CHK'D: GGA  |  | 2022/07/19             |  | DOCUMENT NUMBER   |  |
|   |  |       |  | APPR: GGA   |  | 2022/07/19             |  |   |  |
|   |  |       |  | INITIAL REVISION:   |  |                        |  | SD-121050-001   |  |
|   |  |       |  | DRWN: JMARSZALEK  |  | 2012/08/27             |  |   |  |
|   |  |       |  | APPR: MDYSZEWSKA  |  | 2012/08/20             |  | DOC TYPE  |  |
|   |  |       |  | ANGULAR TOL   |  |                        |  | DOC PART  |  |
|   |  |       |  | DRAFT WHERE APPLICABLE MUST REMAIN WITHIN DIMENSIONS              |  | FIRST ANGLE PROJECTION |  | REVISION  |  |
|   |  |       |  |   |  | DRAWING                |  | PSD   |  |
|   |  |       |  |   |  | SERIES                 |  | 001   |  |
|   |  |       |  |   |  | MATERIAL NUMBER        |  | E1  |  |
|   |  |       |  |   |  | CUSTOMER               |  |   |  |
|   |  |       |  |   |  | SHEET NUMBER           |  |   |  |
|   |  |       |  |   |  | SEE TABLE              |  | 20 OF 41  |  |
|   |  |       |  |   |  | GENERAL MARKET         |  |   |  |



TABLE 3 - PART LIST

| Pos. | Molex PN:  | Engineering No.: |
|------|------------|------------------|
| 2761 | 2210503408 | E452B3A50011C4L  |
| 2762 | 2210503409 | E452B3A50011C4M  |
| 2763 | 2210503414 | E452B3A50011E05  |
| 2764 | N/A        | N/A              |
| 2765 | N/A        | N/A              |
| 2766 | N/A        | N/A              |
| 2767 | N/A        | N/A              |
| 2768 | 2210503429 | E452B3A50011R05  |
| 2769 | N/A        | N/A              |
| 2770 | N/A        | N/A              |
| 2771 | N/A        | N/A              |
| 2772 | N/A        | N/A              |
| 2773 | N/A        | N/A              |
| 2774 | N/A        | N/A              |
| 2775 | N/A        | N/A              |
| 2776 | N/A        | N/A              |
| 2777 | N/A        | N/A              |
| 2778 | N/A        | N/A              |
| 2779 | 2210503440 | E452B3A50011R21  |
| 2780 | 2210503441 | E452B3A50011R22  |
| 2781 | 2210503442 | E452B3A50011R23  |
| 2782 | 2210503443 | E452B3A50011R24  |
| 2783 | 2210503444 | E452B3A50011R25  |
| 2784 | 2210503445 | E452B3A50011R2A  |
| 2785 | 2210503446 | E452B3A50011R2B  |
| 2786 | 2210503447 | E452B3A50011R2C  |
| 2787 | 2210503448 | E452B3A50011R2D  |
| 2788 | 2210503449 | E452B3A50011R2E  |
| 2789 | 2210503450 | E452B3A50011R2G  |
| 2790 | 2210503451 | E452B3A50011R2H  |
| 2791 | 2210503452 | E452B3A50011R2K  |
| 2792 | 2210503453 | E452B3A50011R2L  |
| 2793 | 2210503454 | E452B3A50011R2M  |
| 2794 | 2210503455 | E452B3A50011S01  |
| 2795 | 2210503456 | E452B3A50011S02  |
| 2796 | 2210503457 | E452B3A50011S03  |
| 2797 | 2210503458 | E452B3A50011S04  |
| 2798 | 2210503459 | E452B3A50011S05  |
| 2799 | 2210503460 | E452B3A50011S0A  |
| 2800 | 2210503461 | E452B3A50011S0B  |

| Pos. | Molex PN:  | Engineering No.: |
|------|------------|------------------|
| 2801 | 2210503462 | E452B3A50011S0C  |
| 2802 | 2210503463 | E452B3A50011S0D  |
| 2803 | 2210503464 | E452B3A50011S0E  |
| 2804 | 2210503465 | E452B3A50011S0G  |
| 2805 | 2210503466 | E452B3A50011S0H  |
| 2806 | 2210503467 | E452B3A50011S0K  |
| 2807 | 2210503468 | E452B3A50011S0L  |
| 2808 | 2210503469 | E452B3A50011S0M  |
| 2809 | 2210503470 | E452I2N20011A11  |
| 2810 | 2210503471 | E452I2N20011A12  |
| 2811 | 2210503472 | E452I2N20011A13  |
| 2812 | 2210503473 | E452I2N20011A14  |
| 2813 | 2210503474 | E452I2N20011A15  |
| 2814 | 2210503475 | E452I2N20011A1A  |
| 2815 | 2210503476 | E452I2N20011A1B  |
| 2816 | 2210503477 | E452I2N20011A1C  |
| 2817 | 2210503478 | E452I2N20011A1D  |
| 2818 | 2210503479 | E452I2N20011A1E  |
| 2819 | 2210503480 | E452I2N20011A1G  |
| 2820 | 2210503481 | E452I2N20011A1H  |
| 2821 | 2210503482 | E452I2N20011A1K  |
| 2822 | 2210503483 | E452I2N20011A1L  |
| 2823 | 2210503484 | E452I2N20011A1M  |
| 2824 | 2210503485 | E452I2N20011C31  |
| 2825 | 2210503486 | E452I2N20011C32  |
| 2826 | 2210503487 | E452I2N20011C33  |
| 2827 | 2210503488 | E452I2N20011C34  |
| 2828 | 2210503489 | E452I2N20011C35  |
| 2829 | 2210503490 | E452I2N20011C3A  |
| 2830 | 2210503491 | E452I2N20011C3B  |
| 2831 | 2210503492 | E452I2N20011C3C  |
| 2832 | 2210503493 | E452I2N20011C3D  |
| 2833 | 2210503494 | E452I2N20011C3E  |
| 2834 | 2210503495 | E452I2N20011C3G  |
| 2835 | 2210503497 | E452I2N20011C3K  |
| 2836 | 2210503498 | E452I2N20011C3L  |
| 2837 | 2210503499 | E452I2N20011C3M  |
| 2838 | 2210503501 | E452I2N10011000  |
| 2839 | 2210503502 | E452I2N10011A11  |
| 2840 | 2210503503 | E452I2N10011A12  |

| Pos. | Molex PN:  | Engineering No.: |
|------|------------|------------------|
| 2841 | 2210503504 | E452I2N10011A13  |
| 2842 | 2210503505 | E452I2N10011A14  |
| 2843 | 2210503506 | E452I2N10011A15  |
| 2844 | 2210503507 | E452I2N10011A1A  |
| 2845 | 2210503508 | E452I2N10011A1B  |
| 2846 | 2210503509 | E452I2N10011A1C  |
| 2847 | 2210503510 | E452I2N10011A1D  |
| 2848 | 2210503511 | E452I2N10011A1E  |
| 2849 | 2210503512 | E452I2N10011A1G  |
| 2850 | 2210503513 | E452I2N10011A1H  |
| 2851 | 2210503514 | E452I2N10011A1K  |
| 2852 | 2210503515 | E452I2N10011A1L  |
| 2853 | 2210503516 | E452I2N10011A1M  |
| 2854 | 2210503517 | E452I2N10011C31  |
| 2855 | 2210503518 | E452I2N10011C32  |
| 2856 | 2210503519 | E452I2N10011C33  |
| 2857 | 2210503520 | E452I2N10011C34  |
| 2858 | 2210503521 | E452I2N10011C35  |
| 2859 | 2210503522 | E452I2N10011C3A  |
| 2860 | 2210503523 | E452I2N10011C3B  |
| 2861 | 2210503524 | E452I2N10011C3C  |
| 2862 | 2210503525 | E452I2N10011C3D  |
| 2863 | 2210503526 | E452I2N10011C3E  |
| 2864 | 2210503527 | E452I2N10011C3G  |
| 2865 | 2210503528 | E452I2N10011C3H  |
| 2866 | 2210503529 | E452I2N10011C3K  |
| 2867 | 2210503530 | E452I2N10011C3L  |
| 2868 | 2210503531 | E452I2N10011C3M  |
| 2869 | 2210503532 | E452I2N10011C41  |
| 2870 | 2210503533 | E452I2N10011C43  |
| 2871 | 2210503534 | E452I2N10011C44  |
| 2872 | 2210503535 | E452I2N10011C45  |
| 2873 | 2210503536 | E452I2N10011C4A  |
| 2874 | 2210503537 | E452I2N10011C4B  |
| 2875 | 2210503538 | E452I2N10011C4C  |
| 2876 | 2210503539 | E452I2N10011C4D  |
| 2877 | 2210503540 | E452I2N10011C4E  |
| 2878 | 2210503541 | E452I2N10011C4G  |
| 2879 | 2210503542 | E452I2N10011C4K  |
| 2880 | 2210503543 | E452I2N10011C4L  |

| Pos. | Molex PN:  | Engineering No.: |
|------|------------|------------------|
| 2881 | 2210503544 | E452I2N10011C4M  |
| 2882 | 2210503549 | E452I2N10011E05  |
| 2883 | N/A        | N/A              |
| 2884 | N/A        | N/A              |
| 2885 | N/A        | N/A              |
| 2886 | N/A        | N/A              |
| 2887 | 2210503564 | E452I2N10011R05  |
| 2888 | N/A        | N/A              |
| 2889 | N/A        | N/A              |
| 2890 | N/A        | N/A              |
| 2891 | N/A        | N/A              |
| 2892 | N/A        | N/A              |
| 2893 | N/A        | N/A              |
| 2894 | N/A        | N/A              |
| 2895 | N/A        | N/A              |
| 2896 | N/A        | N/A              |
| 2897 | N/A        | N/A              |
| 2898 | 2210503575 | E452I2N10011R21  |
| 2899 | 2210503576 | E452I2N10011R22  |
| 2900 | 2210503577 | E452I2N10011R23  |
| 2901 | 2210503578 | E452I2N10011R24  |
| 2902 | 2210503579 | E452I2N10011R25  |
| 2903 | 2210503580 | E452I2N10011R2A  |
| 2904 | 2210503581 | E452I2N10011R2B  |
| 2905 | 2210503582 | E452I2N10011R2C  |
| 2906 | 2210503583 | E452I2N10011R2D  |
| 2907 | 2210503584 | E452I2N10011R2E  |
| 2908 | 2210503585 | E452I2N10011R2G  |
| 2909 | 2210503586 | E452I2N10011R2H  |
| 2910 | 2210503587 | E452I2N10011R2K  |
| 2911 | 2210503588 | E452I2N10011R2L  |
| 2912 | 2210503589 | E452I2N10011R2M  |
| 2913 | 2210503590 | E452I2N10011S01  |
| 2914 | 2210503591 | E452I2N10011S02  |
| 2915 | 2210503592 | E452I2N10011S03  |
| 2916 | 2210503593 | E452I2N10011S04  |
| 2917 | 2210503594 | E452I2N10011S05  |
| 2918 | 2210503595 | E452I2N10011S0A  |
| 2919 | 2210503596 | E452I2N10011S0B  |
| 2920 | 2210503597 | E452I2N10011S0C  |

|   |  |       |  |   |  |                 |  |   |  |
|---|--|-------|--|---|--|-----------------|--|---|--|
| THIS DRAWING CONTAINS INFORMATION THAT IS PROPRIETARY TO MOLEX ELECTRONIC TECHNOLOGIES, LLC AND SHOULD NOT BE USED WITHOUT WRITTEN PERMISSION |  |       |  |   |  |                 |  |   |  |
| DIMENSION UNITS   |  | SCALE |  | CURRENT REV DESC: REVISION CREATED FOR REMOVING PRE-RELEASE STAMP                     |  |                 |  |  |  |
| mm  |  | NTS   |  |   |  |                 |  |   |  |
| GENERAL TOLERANCES (UNLESS SPECIFIED)   |  |       |  | EC NO: 714567   |  | 2022/07/18      |  | PRODUCT CUSTOMER DRAWING<br>E452XXXXXXXXXX<br>DIN FORM A EN 175301-803                |  |
|   |  |       |  | DRWN: SUGEEB  |  | 2022/07/19      |  |   |  |
|   |  |       |  | CHK'D: GGA  |  | 2022/07/19      |  | DOCUMENT NUMBER<br><b>SD-121050-001</b>   |  |
|   |  |       |  | APPR: GGA   |  | 2022/07/19      |  |   |  |
|   |  |       |  | INITIAL REVISION:   |  | 2012/08/27      |  | DOC TYPE<br>PSD   |  |
|   |  |       |  | DRWN: JMARSZALEK  |  | 2012/08/27      |  |   |  |
|   |  |       |  | APPR: MDYSZEWSKA  |  | 2012/08/20      |  | DOC PART<br>001   |  |
|   |  |       |  |   |  |                 |  |   |  |
| DRAFT WHERE APPLICABLE MUST REMAIN WITHIN DIMENSIONS  |  |       |  | FIRST ANGLE PROJECTION  |  | DRAWING         |  | REVISION<br><b>E1</b>   |  |
|   |  |       |  |  |  | A3-SIZE         |  |   |  |
|   |  |       |  | SERIES  |  | MATERIAL NUMBER |  | SHEET NUMBER  |  |
|   |  |       |  | 121050  |  | SEE TABLE       |  | 21 OF 41  |  |
|   |  |       |  | CUSTOMER  |  | GENERAL MARKET  |  |   |  |



TABLE 3 - PART LIST

| Pos. | Molex PN:  | Engineering No.: |
|------|------------|------------------|
| 2921 | 2210503598 | E452I2N10011S0D  |
| 2922 | 2210503599 | E452I2N10011S0E  |
| 2923 | 2210503600 | E452I2N10011S0G  |
| 2924 | 2210503601 | E452I2N10011S0H  |
| 2925 | 2210503602 | E452I2N10011S0K  |
| 2926 | 2210503603 | E452I2N10011S0L  |
| 2927 | 2210503604 | E452I2N10011S0M  |
| 2928 | 2210503605 | E452I2N10K11000  |
| 2929 | 2210503606 | E452I2N10K11A11  |
| 2930 | 2210503607 | E452I2N10K11A12  |
| 2931 | 2210503608 | E452I2N10K11A13  |
| 2932 | 2210503609 | E452I2N10K11A14  |
| 2933 | 2210503610 | E452I2N10K11A15  |
| 2934 | 2210503611 | E452I2N10K11A1A  |
| 2935 | 2210503612 | E452I2N10K11A1B  |
| 2936 | 2210503613 | E452I2N10K11A1C  |
| 2937 | 2210503614 | E452I2N10K11A1D  |
| 2938 | 2210503615 | E452I2N10K11A1E  |
| 2939 | 2210503616 | E452I2N10K11A1G  |
| 2940 | 2210503617 | E452I2N10K11A1H  |
| 2941 | 2210503618 | E452I2N10K11A1K  |
| 2942 | 2210503619 | E452I2N10K11A1L  |
| 2943 | 2210503620 | E452I2N10K11A1M  |
| 2944 | 2210503621 | E452I2N10K11C31  |
| 2945 | 2210503622 | E452I2N10K11C32  |
| 2946 | 2210503623 | E452I2N10K11C33  |
| 2947 | 2210503624 | E452I2N10K11C34  |
| 2948 | 2210503625 | E452I2N10K11C35  |
| 2949 | 2210503626 | E452I2N10K11C3A  |
| 2950 | 2210503627 | E452I2N10K11C3B  |
| 2951 | 2210503628 | E452I2N10K11C3C  |
| 2952 | 2210503629 | E452I2N10K11C3D  |
| 2953 | 2210503630 | E452I2N10K11C3E  |
| 2954 | 2210503631 | E452I2N10K11C3G  |
| 2955 | 2210503632 | E452I2N10K11C3H  |
| 2956 | 2210503633 | E452I2N10K11C3K  |
| 2957 | 2210503634 | E452I2N10K11C3L  |
| 2958 | 2210503635 | E452I2N10K11C3M  |
| 2959 | 2210503636 | E452I2N10K11C41  |
| 2960 | 2210503637 | E452I2N10K11C42  |

| Pos. | Molex PN:  | Engineering No.: |
|------|------------|------------------|
| 2961 | 2210503638 | E452I2N10K11C43  |
| 2962 | 2210503639 | E452I2N10K11C44  |
| 2963 | 2210503640 | E452I2N10K11C45  |
| 2964 | 2210503641 | E452I2N10K11C4A  |
| 2965 | 2210503642 | E452I2N10K11C4B  |
| 2966 | 2210503643 | E452I2N10K11C4C  |
| 2967 | 2210503644 | E452I2N10K11C4D  |
| 2968 | 2210503645 | E452I2N10K11C4E  |
| 2969 | 2210503646 | E452I2N10K11C4G  |
| 2970 | 2210503647 | E452I2N10K11C4K  |
| 2971 | 2210503648 | E452I2N10K11C4L  |
| 2972 | 2210503649 | E452I2N10K11C4M  |
| 2973 | 2210503654 | E452I2N10K11E05  |
| 2974 | N/A        | N/A              |
| 2975 | N/A        | N/A              |
| 2976 | N/A        | N/A              |
| 2977 | N/A        | N/A              |
| 2978 | 2210503669 | E452I2N10K11R05  |
| 2979 | N/A        | N/A              |
| 2980 | N/A        | N/A              |
| 2981 | N/A        | N/A              |
| 2982 | N/A        | N/A              |
| 2983 | N/A        | N/A              |
| 2984 | N/A        | N/A              |
| 2985 | N/A        | N/A              |
| 2986 | N/A        | N/A              |
| 2987 | N/A        | N/A              |
| 2988 | N/A        | N/A              |
| 2989 | 2210503680 | E452I2N10K11R21  |
| 2990 | 2210503681 | E452I2N10K11R22  |
| 2991 | 2210503682 | E452I2N10K11R23  |
| 2992 | 2210503683 | E452I2N10K11R24  |
| 2993 | 2210503684 | E452I2N10K11R25  |
| 2994 | 2210503685 | E452I2N10K11R2A  |
| 2995 | 2210503686 | E452I2N10K11R2B  |
| 2996 | 2210503687 | E452I2N10K11R2C  |
| 2997 | 2210503688 | E452I2N10K11R2D  |
| 2998 | 2210503689 | E452I2N10K11R2E  |
| 2999 | 2210503690 | E452I2N10K11R2G  |
| 3000 | 2210503691 | E452I2N10K11R2H  |

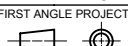
| Pos. | Molex PN:  | Engineering No.: |
|------|------------|------------------|
| 3001 | 2210503692 | E452I2N10K11R2K  |
| 3002 | 2210503693 | E452I2N10K11R2L  |
| 3003 | 2210503694 | E452I2N10K11R2M  |
| 3004 | 2210503695 | E452I2N10K11S01  |
| 3005 | 2210503696 | E452I2N10K11S02  |
| 3006 | 2210503697 | E452I2N10K11S03  |
| 3007 | 2210503698 | E452I2N10K11S04  |
| 3008 | 2210503699 | E452I2N10K11S05  |
| 3009 | 2210503700 | E452I2N10K11S0A  |
| 3010 | 2210503701 | E452I2N10K11S0B  |
| 3011 | 2210503702 | E452I2N10K11S0C  |
| 3012 | 2210503703 | E452I2N10K11S0D  |
| 3013 | 2210503704 | E452I2N10K11S0E  |
| 3014 | 2210503705 | E452I2N10K11S0G  |
| 3015 | 2210503706 | E452I2N10K11S0H  |
| 3016 | 2210503707 | E452I2N10K11S0K  |
| 3017 | 2210503708 | E452I2N10K11S0L  |
| 3018 | 2210503709 | E452I2N10K11S0M  |
| 3019 | 2210503710 | E452I2N15011000  |
| 3020 | 2210503711 | E452I2N15011A11  |
| 3021 | 2210503712 | E452I2N15011A12  |
| 3022 | 2210503713 | E452I2N15011A13  |
| 3023 | 2210503714 | E452I2N15011A14  |
| 3024 | 2210503715 | E452I2N15011A15  |
| 3025 | 2210503716 | E452I2N15011A1A  |
| 3026 | 2210503717 | E452I2N15011A1B  |
| 3027 | 2210503718 | E452I2N15011A1C  |
| 3028 | 2210503719 | E452I2N15011A1D  |
| 3029 | 2210503720 | E452I2N15011A1E  |
| 3030 | 2210503721 | E452I2N15011A1G  |
| 3031 | 2210503722 | E452I2N15011A1H  |
| 3032 | 2210503723 | E452I2N15011A1K  |
| 3033 | 2210503724 | E452I2N15011A1L  |
| 3034 | 2210503725 | E452I2N15011A1M  |
| 3035 | 2210503726 | E452I2N15011C31  |
| 3036 | 2210503727 | E452I2N15011C32  |
| 3037 | 2210503728 | E452I2N15011C33  |
| 3038 | 2210503729 | E452I2N15011C34  |
| 3039 | 2210503730 | E452I2N15011C35  |
| 3040 | 2210503731 | E452I2N15011C3A  |

| Pos. | Molex PN:  | Engineering No.: |
|------|------------|------------------|
| 3041 | 2210503732 | E452I2N15011C3B  |
| 3042 | 2210503733 | E452I2N15011C3C  |
| 3043 | 2210503734 | E452I2N15011C3D  |
| 3044 | 2210503735 | E452I2N15011C3E  |
| 3045 | 2210503736 | E452I2N15011C3G  |
| 3046 | 2210503737 | E452I2N15011C3K  |
| 3047 | 2210503738 | E452I2N15011C3L  |
| 3048 | 2210503739 | E452I2N15011C3M  |
| 3049 | 2210503740 | E452I2N15011C41  |
| 3050 | 2210503741 | E452I2N15011C42  |
| 3051 | 2210503742 | E452I2N15011C43  |
| 3052 | 2210503743 | E452I2N15011C44  |
| 3053 | 2210503744 | E452I2N15011C45  |
| 3054 | 2210503745 | E452I2N15011C4A  |
| 3055 | 2210503746 | E452I2N15011C4B  |
| 3056 | 2210503747 | E452I2N15011C4C  |
| 3057 | 2210503748 | E452I2N15011C4D  |
| 3058 | 2210503749 | E452I2N15011C4E  |
| 3059 | 2210503750 | E452I2N15011C4G  |
| 3060 | 2210503751 | E452I2N15011C4H  |
| 3061 | 2210503752 | E452I2N15011C4K  |
| 3062 | 2210503753 | E452I2N15011C4L  |
| 3063 | 2210503754 | E452I2N15011C4M  |
| 3064 | 2210503759 | E452I2N15011E05  |
| 3065 | N/A        | N/A              |
| 3066 | N/A        | N/A              |
| 3067 | N/A        | N/A              |
| 3068 | N/A        | N/A              |
| 3069 | 2210503774 | E452I2N15011R05  |
| 3070 | N/A        | N/A              |
| 3071 | N/A        | N/A              |
| 3072 | N/A        | N/A              |
| 3073 | N/A        | N/A              |
| 3074 | N/A        | N/A              |
| 3075 | N/A        | N/A              |
| 3076 | N/A        | N/A              |
| 3077 | N/A        | N/A              |
| 3078 | N/A        | N/A              |
| 3079 | N/A        | N/A              |
| 3080 | 2210503785 | E452I2N15011R21  |

|   |  |       |  |   |  |            |  |   |  |
|---|--|-------|--|---|--|------------|--|---|--|
| THIS DRAWING CONTAINS INFORMATION THAT IS PROPRIETARY TO MOLEX ELECTRONIC TECHNOLOGIES, LLC AND SHOULD NOT BE USED WITHOUT WRITTEN PERMISSION |  |       |  |   |  |            |  |   |  |
| DIMENSION UNITS   |  | SCALE |  | CURRENT REV DESC: REVISION CREATED FOR REMOVING PRE-RELEASE STAMP                     |  |            |  | <br>E452XXXXXXXXXX<br>DIN FORM A EN 175301-803 |  |
| mm  |  | NTS   |  |   |  |            |  |   |  |
| GENERAL TOLERANCES (UNLESS SPECIFIED)   |  |       |  | EC NO: 714567   |  | 2022/07/18 |  | PRODUCT CUSTOMER DRAWING<br>DOCUMENT NUMBER: SD-121050-001   DOC TYPE: PSD   DOC PART: 001   REVISION: E1                           |  |
|   |  |       |  | DRWN: SUGEEB  |  | 2022/07/19 |  |   |  |
|   |  |       |  | CHK'D: GGA  |  | 2022/07/19 |  |   |  |
|   |  |       |  | APPR: GGA   |  |            |  |   |  |
|   |  |       |  | INITIAL REVISION:   |  |            |  |   |  |
|   |  |       |  | DRWN: JMARSZALEK  |  | 2012/08/27 |  |   |  |
|   |  |       |  | APPR: MDYSZEWSKA  |  | 2012/08/20 |  |   |  |
| DRAFT WHERE APPLICABLE MUST REMAIN WITHIN DIMENSIONS  |  |       |  | FIRST ANGLE PROJECTION  |  | DRAWING    |  | SHEET NUMBER  |  |
|   |  |       |  |  |  | A3-SIZE    |  | 22 OF 41  |  |

TABLE 3 - PART LIST

| Pos. | Molex PN:  | Engineering No.: |
|------|------------|------------------|
| 3081 | 2210503786 | E452I2N15011R22  |
| 3082 | 2210503787 | E452I2N15011R23  |
| 3083 | 2210503788 | E452I2N15011R24  |
| 3084 | 2210503789 | E452I2N15011R25  |
| 3085 | 2210503790 | E452I2N15011R2A  |
| 3086 | 2210503791 | E452I2N15011R2B  |
| 3087 | 2210503792 | E452I2N15011R2C  |
| 3088 | 2210503793 | E452I2N15011R2D  |
| 3089 | 2210503794 | E452I2N15011R2E  |
| 3090 | 2210503795 | E452I2N15011R2G  |
| 3091 | 2210503796 | E452I2N15011R2H  |
| 3092 | 2210503797 | E452I2N15011R2K  |
| 3093 | 2210503798 | E452I2N15011R2L  |
| 3094 | 2210503799 | E452I2N15011R2M  |
| 3095 | 2210503800 | E452I2N15011S01  |
| 3096 | 2210503801 | E452I2N15011S02  |
| 3097 | 2210503802 | E452I2N15011S03  |
| 3098 | 2210503803 | E452I2N15011S04  |
| 3099 | 2210503804 | E452I2N15011S05  |
| 3100 | 2210503805 | E452I2N15011S0A  |
| 3101 | 2210503806 | E452I2N15011S0B  |
| 3102 | 2210503807 | E452I2N15011S0C  |
| 3103 | 2210503808 | E452I2N15011S0D  |
| 3104 | 2210503809 | E452I2N15011S0E  |
| 3105 | 2210503810 | E452I2N15011S0G  |
| 3106 | 2210503811 | E452I2N15011S0H  |
| 3107 | 2210503812 | E452I2N15011S0K  |
| 3108 | 2210503813 | E452I2N15011S0L  |
| 3109 | 2210503814 | E452I2N15011S0M  |
| 3110 | 2210503815 | E452I2N20011000  |
| 3111 | 2210503816 | E452I2N20011C41  |
| 3112 | 2210503817 | E452I2N20011C42  |
| 3113 | 2210503818 | E452I2N20011C43  |
| 3114 | 2210503819 | E452I2N20011C44  |
| 3115 | 2210503820 | E452I2N20011C45  |
| 3116 | 2210503821 | E452I2N20011C4A  |
| 3117 | 2210503822 | E452I2N20011C4B  |
| 3118 | 2210503823 | E452I2N20011C4C  |
| 3119 | 2210503824 | E452I2N20011C4D  |
| 3120 | 2210503825 | E452I2N20011C4E  |

| Pos. | Molex PN:  | Engineering No.: |
|------|------------|------------------|
| 3121 | 2210503826 | E452I2N20011C4G  |
| 3122 | 2210503827 | E452I2N20011C4K  |
| 3123 | 2210503828 | E452I2N20011C4L  |
| 3124 | 2210503829 | E452I2N20011C4M  |
| 3125 | 2210503830 | E452I2N20011C4N  |
| 3126 | 2210503831 | E452I2N20011C4O  |
| 3127 | 2210503832 | E452I2N20011C4P  |
| 3128 | 2210503833 | E452I2N20011C4Q  |
| 3129 | 2210503834 | E452I2N20011C4R  |
| 3130 | 2210503835 | E452I2N20011C4S  |
| 3131 | 2210503836 | E452I2N20011C4T  |
| 3132 | 2210503837 | E452I2N20011C4U  |
| 3133 | 2210503838 | E452I2N20011C4V  |
| 3134 | 2210503839 | E452I2N20011C4W  |
| 3135 | 2210503840 | E452I2N20011C4X  |
| 3136 | 2210503841 | E452I2N20011C4Y  |
| 3137 | 2210503842 | E452I2N20011C4Z  |
| 3138 | 2210503843 | E452I2N20011C4AA |
| 3139 | 2210503844 | E452I2N20011C4AB |
| 3140 | 2210503845 | E452I2N20011C4AC |
| 3141 | 2210503846 | E452I2N20011C4AD |
| 3142 | 2210503847 | E452I2N20011C4AE |
| 3143 | 2210503848 | E452I2N20011C4AF |
| 3144 | 2210503849 | E452I2N20011C4AG |
| 3145 | 2210503850 | E452I2N20011C4AH |
| 3146 | 2210503851 | E452I2N20011C4AI |
| 3147 | 2210503852 | E452I2N20011C4AJ |
| 3148 | 2210503853 | E452I2N20011C4AK |
| 3149 | 2210503854 | E452I2N20011C4AL |
| 3150 | 2210503855 | E452I2N20011C4AM |
| 3151 | 2210503856 | E452I2N20011C4AN |
| 3152 | 2210503857 | E452I2N20011C4AO |
| 3153 | 2210503858 | E452I2N20011C4AP |
| 3154 | 2210503859 | E452I2N20011C4AQ |
| 3155 | 2210503860 | E452I2N20011C4AR |
| 3156 | 2210503861 | E452I2N20011C4AS |
| 3157 | 2210503862 | E452I2N20011C4AT |
| 3158 | 2210503863 | E452I2N20011C4AU |
| 3159 | 2210503864 | E452I2N20011C4AV |
| 3160 | 2210503865 | E452I2N20011C4AW |

| Pos. | Molex PN:  | Engineering No.: |
|------|------------|------------------|
| 3161 | 2210503866 | E452I2N20011C4AX |
| 3162 | 2210503867 | E452I2N20011C4AY |
| 3163 | 2210503868 | E452I2N20011C4AZ |
| 3164 | 2210503869 | E452I2N20011C4BA |
| 3165 | 2210503870 | E452I2N20011C4BB |
| 3166 | 2210503871 | E452I2N20011C4BC |
| 3167 | 2210503872 | E452I2N20011C4BD |
| 3168 | 2210503873 | E452I2N20011C4BE |
| 3169 | 2210503874 | E452I2N20011C4BF |
| 3170 | 2210503875 | E452I2N20011C4BG |
| 3171 | 2210503876 | E452I2N20011C4BH |
| 3172 | 2210503877 | E452I2N20011C4BI |
| 3173 | 2210503878 | E452I2N20011C4BJ |
| 3174 | 2210503879 | E452I2N20011C4BK |
| 3175 | 2210503880 | E452I2N20011C4BL |
| 3176 | 2210503881 | E452I2N20011C4BM |
| 3177 | 2210503882 | E452I2N20011C4BN |
| 3178 | 2210503883 | E452I2N20011C4BO |
| 3179 | 2210503884 | E452I2N20011C4BP |
| 3180 | 2210503885 | E452I2N20011C4BQ |
| 3181 | 2210503886 | E452I2N20011C4BR |
| 3182 | 2210503887 | E452I2N20011C4BS |
| 3183 | 2210503888 | E452I2N20011C4BT |
| 3184 | 2210503889 | E452I2N20011C4BU |
| 3185 | 2210503890 | E452I2N20011C4BV |
| 3186 | 2210503891 | E452I2N20011C4BW |
| 3187 | 2210503892 | E452I2N20011C4BX |
| 3188 | 2210503893 | E452I2N20011C4BY |
| 3189 | 2210503894 | E452I2N20011C4BZ |
| 3190 | 2210503895 | E452I2N20011C4CA |
| 3191 | 2210503896 | E452I2N20011C4CB |
| 3192 | 2210503897 | E452I2N20011C4CC |
| 3193 | 2210503898 | E452I2N20011C4CD |
| 3194 | 2210503899 | E452I2N20011C4CE |
| 3195 | 2210503900 | E452I2N20011C4CF |
| 3196 | 2210503901 | E452I2N20011C4CG |
| 3197 | 2210503902 | E452I2N20011C4CH |
| 3198 | 2210503903 | E452I2N20011C4CI |
| 3199 | 2210503904 | E452I2N20011C4CJ |
| 3200 | 2210503905 | E452I2N20011C4CK |

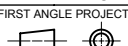
| Pos. | Molex PN:  | Engineering No.: |
|------|------------|------------------|
| 3201 | 2210503906 | E452I2N20011C4CL |
| 3202 | 2210503907 | E452I2N20011C4CM |
| 3203 | 2210503908 | E452I2N20011C4CN |
| 3204 | 2210503909 | E452I2N20011C4CO |
| 3205 | 2210503910 | E452I2N20011C4CP |
| 3206 | 2210503911 | E452I2N20011C4CQ |
| 3207 | 2210503912 | E452I2N20011C4CR |
| 3208 | 2210503913 | E452I2N20011C4CS |
| 3209 | 2210503914 | E452I2N20011C4CT |
| 3210 | 2210503915 | E452I2N20011C4CU |
| 3211 | 2210503916 | E452I2N20011C4CV |
| 3212 | 2210503917 | E452I2N20011C4CW |
| 3213 | 2210503918 | E452I2N20011C4CX |
| 3214 | 2210503919 | E452I2N20011C4CY |
| 3215 | 2210503920 | E452I2N20011C4CZ |
| 3216 | 2210503921 | E452I2N20011C4DA |
| 3217 | 2210503922 | E452I2N20011C4DB |
| 3218 | 2210503923 | E452I2N20011C4DC |
| 3219 | 2210503924 | E452I2N20011C4DD |
| 3220 | 2210503925 | E452I2N20011C4DE |
| 3221 | 2210503926 | E452I2N20011C4DF |
| 3222 | 2210503927 | E452I2N20011C4DG |
| 3223 | 2210503928 | E452I2N20011C4DH |
| 3224 | 2210503929 | E452I2N20011C4DI |
| 3225 | 2210503930 | E452I2N20011C4DJ |
| 3226 | 2210503931 | E452I2N20011C4DK |
| 3227 | 2210503932 | E452I2N20011C4DL |
| 3228 | 2210503933 | E452I2N20011C4DM |
| 3229 | 2210503934 | E452I2N20011C4DN |
| 3230 | 2210503935 | E452I2N20011C4DO |
| 3231 | 2210503936 | E452I2N20011C4DP |
| 3232 | 2210503937 | E452I2N20011C4DQ |
| 3233 | 2210503938 | E452I2N20011C4DR |
| 3234 | 2210503939 | E452I2N20011C4DS |
| 3235 | 2210503940 | E452I2N20011C4DT |
| 3236 | 2210503941 | E452I2N20011C4DU |
| 3237 | 2210503942 | E452I2N20011C4DV |
| 3238 | 2210503943 | E452I2N20011C4DW |
| 3239 | 2210503944 | E452I2N20011C4DX |
| 3240 | 2210503945 | E452I2N20011C4DY |

|   |  |             |  |   |  |            |  |   |  |
|---|--|-------------|--|---|--|------------|--|---|--|
| THIS DRAWING CONTAINS INFORMATION THAT IS PROPRIETARY TO MOLEX ELECTRONIC TECHNOLOGIES, LLC AND SHOULD NOT BE USED WITHOUT WRITTEN PERMISSION |  |             |  |   |  |            |  |   |  |
| DIMENSION UNITS   |  | SCALE       |  | CURRENT REV DESC: REVISION CREATED FOR REMOVING PRE-RELEASE STAMP                     |  |            |  | <br>E452XXXXXXXXXX<br>DIN FORM A EN 175301-803 |  |
| mm  |  | NTS         |  |   |  |            |  |   |  |
| GENERAL TOLERANCES (UNLESS SPECIFIED)   |  |             |  |   |  |            |  |   |  |
|   |  | MM          |  | INCH  |  |            |  |   |  |
| 4 PLACES  |  | ±           |  | ±   |  |            |  |   |  |
| 3 PLACES  |  | ±           |  | ±   |  |            |  |   |  |
| 2 PLACES  |  | ±           |  | ±   |  |            |  |   |  |
| 1 PLACE   |  | ±           |  | ±   |  |            |  |   |  |
| 0 PLACES  |  | ±           |  | ±   |  |            |  |   |  |
| ANGULAR TOL   |  | ±           |  | °   |  |            |  |   |  |
| DRAFT WHERE APPLICABLE MUST REMAIN WITHIN DIMENSIONS  |  |             |  | FIRST ANGLE PROJECTION  |  | DRAWING    |  | SERIES  |  |
|   |  |             |  |  |  | A3-SIZE    |  | 121050  |  |
| DOCUMENT STATUS   |  | P1          |  | RELEASE DATE  |  | 2022/07/19 |  | 09:04:35  |  |
| FORMAT: Met lega-master-ib-prod-A3  |  | REVISION: E |  | DATE: 2020/01/14  |  | 9          |  | 8   |  |
|   |  |             |  |   |  | 7          |  | 6   |  |
|   |  |             |  |   |  | 5          |  | 4   |  |
|   |  |             |  |   |  | 3          |  | 2   |  |
|   |  |             |  |   |  | 1          |  |   |  |

TABLE 3 - PART LIST

| Pos. | Molex PN:  | Engineering No.: |
|------|------------|------------------|
| 3241 | 2210503973 | E452I2N30011R2M  |
| 3242 | 2210503974 | E452I2N30011S01  |
| 3243 | 2210503975 | E452I2N30011S02  |
| 3244 | 2210503976 | E452I2N30011S03  |
| 3245 | 2210503977 | E452I2N30011S04  |
| 3246 | 2210503978 | E452I2N30011S05  |
| 3247 | 2210503979 | E452I2N30011S0A  |
| 3248 | 2210503980 | E452I2N30011S0B  |
| 3249 | 2210503981 | E452I2N30011S0C  |
| 3250 | 2210503982 | E452I2N30011S0D  |
| 3251 | 2210503983 | E452I2N30011S0E  |
| 3252 | 2210503984 | E452I2N30011S0G  |
| 3253 | 2210503985 | E452I2N30011S0H  |
| 3254 | 2210503986 | E452I2N30011S0K  |
| 3255 | 2210503987 | E452I2N30011S0L  |
| 3256 | 2210503988 | E452I2N30011S0M  |
| 3257 | 2210503989 | E452I2N50011000  |
| 3258 | 2210503990 | E452I2N50011A11  |
| 3259 | 2210503991 | E452I2N50011A12  |
| 3260 | 2210503992 | E452I2N50011A13  |
| 3261 | 2210503993 | E452I2N50011A14  |
| 3262 | 2210503994 | E452I2N50011A15  |
| 3263 | 2210503995 | E452I2N50011A1A  |
| 3264 | 2210503996 | E452I2N50011A1B  |
| 3265 | 2210503997 | E452I2N50011A1C  |
| 3266 | 2210503998 | E452I2N50011A1D  |
| 3267 | 2210503999 | E452I2N50011A1E  |
| 3268 | 2210504000 | E452I2N50011A1G  |
| 3269 | 2210504001 | E452I2N50011A1H  |
| 3270 | 2210504002 | E452I2N50011A1K  |
| 3271 | 2210504003 | E452I2N50011A1L  |
| 3272 | 2210504004 | E452I2N50011A1M  |
| 3273 | 2210504005 | E452I2N50011C31  |
| 3274 | 2210504006 | E452I2N50011C32  |
| 3275 | 2210504007 | E452I2N50011C33  |
| 3276 | 2210504008 | E452I2N50011C34  |
| 3277 | 2210504009 | E452I2N50011C35  |
| 3278 | 2210504010 | E452I2N50011C3A  |
| 3279 | 2210504011 | E452I2N50011C3B  |
| 3280 | 2210504012 | E452I2N50011C3C  |

| Pos. | Molex PN:  | Engineering No.: |
|------|------------|------------------|
| 3281 | 2210504013 | E452I2N50011C3D  |
| 3282 | 2210504014 | E452I2N50011C3E  |
| 3283 | 2210504015 | E452I2N50011C3G  |
| 3284 | 2210504016 | E452I2N50011C3K  |
| 3285 | 2210504017 | E452I2N50011C3L  |
| 3286 | 2210504018 | E452I2N50011C3M  |
| 3287 | 2210504019 | E452I2N50011C41  |
| 3288 | 2210504020 | E452I2N50011C43  |
| 3289 | 2210504021 | E452I2N50011C45  |
| 3290 | 2210504022 | E452I2N50011C4A  |
| 3291 | 2210504023 | E452I2N50011C4B  |
| 3292 | 2210504024 | E452I2N50011C4C  |
| 3293 | 2210504025 | E452I2N50011C4D  |
| 3294 | 2210504026 | E452I2N50011C4E  |
| 3295 | 2210504027 | E452I2N50011C4G  |
| 3296 | 2210504028 | E452I2N50011C4K  |
| 3297 | 2210504029 | E452I2N50011C4L  |
| 3298 | 2210504030 | E452I2N50011C4M  |
| 3299 | 2210504035 | E452I2N50011E05  |
| 3300 | N/A        | N/A              |
| 3301 | N/A        | N/A              |
| 3302 | N/A        | N/A              |
| 3303 | N/A        | N/A              |
| 3304 | 2210504050 | E452I2N50011R05  |
| 3305 | N/A        | N/A              |
| 3306 | N/A        | N/A              |
| 3307 | N/A        | N/A              |
| 3308 | N/A        | N/A              |
| 3309 | N/A        | N/A              |
| 3310 | N/A        | N/A              |
| 3311 | N/A        | N/A              |
| 3312 | N/A        | N/A              |
| 3313 | N/A        | N/A              |
| 3314 | N/A        | N/A              |
| 3315 | 2210504061 | E452I2N50011R21  |
| 3316 | 2210504062 | E452I2N50011R22  |
| 3317 | 2210504063 | E452I2N50011R23  |
| 3318 | 2210504064 | E452I2N50011R24  |
| 3319 | 2210504065 | E452I2N50011R25  |
| 3320 | 2210504066 | E452I2N50011R2A  |

| Pos. | Molex PN:  | Engineering No.: |
|------|------------|------------------|
| 3321 | 2210504067 | E452I2N50011R2B  |
| 3322 | 2210504068 | E452I2N50011R2C  |
| 3323 | 2210504069 | E452I2N50011R2D  |
| 3324 | 2210504070 | E452I2N50011R2E  |
| 3325 | 2210504071 | E452I2N50011R2G  |
| 3326 | 2210504072 | E452I2N50011R2H  |
| 3327 | 2210504073 | E452I2N50011R2K  |
| 3328 | 2210504074 | E452I2N50011R2L  |
| 3329 | 2210504075 | E452I2N50011R2M  |
| 3330 | 2210504076 | E452I2N50011S01  |
| 3331 | 2210504077 | E452I2N50011S02  |
| 3332 | 2210504078 | E452I2N50011S03  |
| 3333 | 2210504079 | E452I2N50011S04  |
| 3334 | 2210504080 | E452I2N50011S05  |
| 3335 | 2210504081 | E452I2N50011S0A  |
| 3336 | 2210504082 | E452I2N50011S0B  |
| 3337 | 2210504083 | E452I2N50011S0C  |
| 3338 | 2210504084 | E452I2N50011S0D  |
| 3339 | 2210504085 | E452I2N50011S0E  |
| 3340 | 2210504086 | E452I2N50011S0G  |
| 3341 | 2210504087 | E452I2N50011S0H  |
| 3342 | 2210504088 | E452I2N50011S0K  |
| 3343 | 2210504089 | E452I2N50011S0L  |
| 3344 | 2210504090 | E452I2N50011S0M  |
| 3345 | 2210504091 | E452I4N10011000  |
| 3346 | 2210504092 | E452I4N10011A11  |
| 3347 | 2210504093 | E452I4N10011A12  |
| 3348 | 2210504094 | E452I4N10011A13  |
| 3349 | 2210504095 | E452I4N10011A14  |
| 3350 | 2210504096 | E452I4N10011A15  |
| 3351 | 2210504097 | E452I4N10011A1A  |
| 3352 | 2210504098 | E452I4N10011A1B  |
| 3353 | 2210504099 | E452I4N10011A1C  |
| 3354 | 2210504100 | E452I4N10011A1D  |
| 3355 | 2210504101 | E452I4N10011A1E  |
| 3356 | 2210504102 | E452I4N10011A1G  |
| 3357 | 2210504103 | E452I4N10011A1H  |
| 3358 | 2210504104 | E452I4N10011A1K  |
| 3359 | 2210504105 | E452I4N10011A1L  |
| 3360 | 2210504106 | E452I4N10011A1M  |

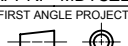
| Pos. | Molex PN:  | Engineering No.: |
|------|------------|------------------|
| 3361 | 2210504107 | E452I4N10011C31  |
| 3362 | 2210504108 | E452I4N10011C32  |
| 3363 | 2210504109 | E452I4N10011C33  |
| 3364 | 2210504110 | E452I4N10011C34  |
| 3365 | 2210504111 | E452I4N10011C35  |
| 3366 | 2210504112 | E452I4N10011C3A  |
| 3367 | 2210504113 | E452I4N10011C3B  |
| 3368 | 2210504114 | E452I4N10011C3C  |
| 3369 | 2210504115 | E452I4N10011C3D  |
| 3370 | 2210504116 | E452I4N10011C3E  |
| 3371 | 2210504117 | E452I4N10011C3G  |
| 3372 | 2210504118 | E452I4N10011C3H  |
| 3373 | 2210504119 | E452I4N10011C3K  |
| 3374 | 2210504120 | E452I4N10011C3L  |
| 3375 | 2210504121 | E452I4N10011C3M  |
| 3376 | 2210504122 | E452I4N10011C41  |
| 3377 | 2210504123 | E452I4N10011C43  |
| 3378 | 2210504124 | E452I4N10011C44  |
| 3379 | 2210504125 | E452I4N10011C45  |
| 3380 | 2210504126 | E452I4N10011C4A  |
| 3381 | 2210504127 | E452I4N10011C4B  |
| 3382 | 2210504128 | E452I4N10011C4C  |
| 3383 | 2210504129 | E452I4N10011C4D  |
| 3384 | 2210504130 | E452I4N10011C4E  |
| 3385 | 2210504131 | E452I4N10011C4G  |
| 3386 | 2210504132 | E452I4N10011C4K  |
| 3387 | 2210504133 | E452I4N10011C4L  |
| 3388 | 2210504134 | E452I4N10011C4M  |
| 3389 | 2210504139 | E452I4N10011E05  |
| 3390 | N/A        | N/A              |
| 3391 | N/A        | N/A              |
| 3392 | N/A        | N/A              |
| 3393 | N/A        | N/A              |
| 3394 | 2210504154 | E452I4N10011R05  |
| 3395 | N/A        | N/A              |
| 3396 | N/A        | N/A              |
| 3397 | N/A        | N/A              |
| 3398 | N/A        | N/A              |
| 3399 | N/A        | N/A              |
| 3400 | N/A        | N/A              |

|   |  |       |  |   |  |                |  |   |  |
|---|--|-------|--|---|--|----------------|--|---|--|
| THIS DRAWING CONTAINS INFORMATION THAT IS PROPRIETARY TO MOLEX ELECTRONIC TECHNOLOGIES, LLC AND SHOULD NOT BE USED WITHOUT WRITTEN PERMISSION |  |       |  |   |  |                |  |   |  |
| DIMENSION UNITS   |  | SCALE |  | CURRENT REV DESC: REVISION CREATED FOR REMOVING PRE-RELEASE STAMP                     |  |                |  | <br>E452XXXXXXXXXX<br>DIN FORM A EN 175301-803 |  |
| mm  |  | NTS   |  |   |  |                |  |   |  |
| GENERAL TOLERANCES (UNLESS SPECIFIED)   |  |       |  | EC NO: 714567   |  | 2022/07/18     |  | PRODUCT CUSTOMER DRAWING<br>DOCUMENT NUMBER: SD-121050-001<br>DOC TYPE: PSD<br>DOC PART: 001<br>REVISION: E1                        |  |
|   |  |       |  | DRWN: SUGEEB  |  | 2022/07/19     |  |   |  |
|   |  |       |  | CHK'D: GGA  |  | 2022/07/19     |  |   |  |
|   |  |       |  | APPR: GGA   |  |                |  |   |  |
|   |  |       |  | INITIAL REVISION:   |  |                |  |   |  |
|   |  |       |  | DRWN: JMARSZALEK  |  | 2012/08/27     |  |   |  |
|   |  |       |  | APPR: MDYSZEWSKA  |  | 2012/08/20     |  |   |  |
|   |  |       |  | FIRST ANGLE PROJECTION  |  | DRAWING        |  | SERIES  |  |
| DRAFT WHERE APPLICABLE MUST REMAIN WITHIN DIMENSIONS  |  |       |  |  |  | A3-SIZE        |  | 121050  |  |
|   |  |       |  | MATERIAL NUMBER   |  | CUSTOMER       |  | SHEET NUMBER  |  |
|   |  |       |  | SEE TABLE   |  | GENERAL MARKET |  | 24 OF 41  |  |

TABLE 3 - PART LIST

| Pos. | Molex PN:  | Engineering No.: |
|------|------------|------------------|
| 3401 | N/A        | N/A              |
| 3402 | N/A        | N/A              |
| 3403 | N/A        | N/A              |
| 3404 | N/A        | N/A              |
| 3405 | 2210504165 | E452I4N10011R21  |
| 3406 | 2210504166 | E452I4N10011R22  |
| 3407 | 2210504167 | E452I4N10011R23  |
| 3408 | 2210504168 | E452I4N10011R24  |
| 3409 | 2210504169 | E452I4N10011R25  |
| 3410 | 2210504170 | E452I4N10011R2A  |
| 3411 | 2210504171 | E452I4N10011R2B  |
| 3412 | 2210504172 | E452I4N10011R2C  |
| 3413 | 2210504173 | E452I4N10011R2D  |
| 3414 | 2210504174 | E452I4N10011R2E  |
| 3415 | 2210504175 | E452I4N10011R2G  |
| 3416 | 2210504176 | E452I4N10011R2H  |
| 3417 | 2210504177 | E452I4N10011R2K  |
| 3418 | 2210504178 | E452I4N10011R2L  |
| 3419 | 2210504179 | E452I4N10011R2M  |
| 3420 | 2210504180 | E452I4N10011S01  |
| 3421 | 2210504181 | E452I4N10011S02  |
| 3422 | 2210504182 | E452I4N10011S03  |
| 3423 | 2210504183 | E452I4N10011S04  |
| 3424 | 2210504184 | E452I4N10011S05  |
| 3425 | 2210504185 | E452I4N10011S0A  |
| 3426 | 2210504186 | E452I4N10011S0B  |
| 3427 | 2210504187 | E452I4N10011S0C  |
| 3428 | 2210504188 | E452I4N10011S0D  |
| 3429 | 2210504189 | E452I4N10011S0E  |
| 3430 | 2210504190 | E452I4N10011S0G  |
| 3431 | 2210504191 | E452I4N10011S0H  |
| 3432 | 2210504192 | E452I4N10011S0K  |
| 3433 | 2210504193 | E452I4N10011S0L  |
| 3434 | 2210504194 | E452I4N10011S0M  |
| 3435 | 2210504195 | E452I4N10K11000  |
| 3436 | 2210504196 | E452I4N10K11A11  |
| 3437 | 2210504197 | E452I4N10K11A12  |
| 3438 | 2210504198 | E452I4N10K11A13  |
| 3439 | 2210504199 | E452I4N10K11A14  |
| 3440 | 2210504200 | E452I4N10K11A15  |

| Pos. | Molex PN:  | Engineering No.: |
|------|------------|------------------|
| 3441 | 2210504201 | E452I4N10K11A1A  |
| 3442 | 2210504202 | E452I4N10K11A1B  |
| 3443 | 2210504203 | E452I4N10K11A1C  |
| 3444 | 2210504204 | E452I4N10K11A1D  |
| 3445 | 2210504205 | E452I4N10K11A1E  |
| 3446 | 2210504206 | E452I4N10K11A1G  |
| 3447 | 2210504207 | E452I4N10K11A1H  |
| 3448 | 2210504208 | E452I4N10K11A1K  |
| 3449 | 2210504209 | E452I4N10K11A1L  |
| 3450 | 2210504210 | E452I4N10K11A1M  |
| 3451 | 2210504211 | E452I4N10K11C31  |
| 3452 | 2210504212 | E452I4N10K11C32  |
| 3453 | 2210504213 | E452I4N10K11C33  |
| 3454 | 2210504214 | E452I4N10K11C34  |
| 3455 | 2210504215 | E452I4N10K11C35  |
| 3456 | 2210504216 | E452I4N10K11C3A  |
| 3457 | 2210504217 | E452I4N10K11C3B  |
| 3458 | 2210504218 | E452I4N10K11C3C  |
| 3459 | 2210504219 | E452I4N10K11C3D  |
| 3460 | 2210504220 | E452I4N10K11C3E  |
| 3461 | 2210504221 | E452I4N10K11C3G  |
| 3462 | 2210504222 | E452I4N10K11C3K  |
| 3463 | 2210504223 | E452I4N10K11C3L  |
| 3464 | 2210504224 | E452I4N10K11C3M  |
| 3465 | 2210504225 | E452I4N10K11C41  |
| 3466 | 2210504226 | E452I4N10K11C42  |
| 3467 | 2210504227 | E452I4N10K11C43  |
| 3468 | 2210504228 | E452I4N10K11C44  |
| 3469 | 2210504229 | E452I4N10K11C45  |
| 3470 | 2210504230 | E452I4N10K11C4A  |
| 3471 | 2210504231 | E452I4N10K11C4B  |
| 3472 | 2210504232 | E452I4N10K11C4C  |
| 3473 | 2210504233 | E452I4N10K11C4D  |
| 3474 | 2210504234 | E452I4N10K11C4E  |
| 3475 | 2210504235 | E452I4N10K11C4G  |
| 3476 | 2210504236 | E452I4N10K11C4K  |
| 3477 | 2210504237 | E452I4N10K11C4M  |
| 3478 | 2210504242 | E452I4N10K11E05  |
| 3479 | N/A        | N/A              |
| 3480 | N/A        | N/A              |

| Pos. | Molex PN:  | Engineering No.: |
|------|------------|------------------|
| 3481 | N/A        | N/A              |
| 3482 | N/A        | N/A              |
| 3483 | 2210504257 | E452I4N10K11R05  |
| 3484 | N/A        | N/A              |
| 3485 | N/A        | N/A              |
| 3486 | N/A        | N/A              |
| 3487 | N/A        | N/A              |
| 3488 | N/A        | N/A              |
| 3489 | N/A        | N/A              |
| 3490 | N/A        | N/A              |
| 3491 | N/A        | N/A              |
| 3492 | N/A        | N/A              |
| 3493 | N/A        | N/A              |
| 3494 | 2210504268 | E452I4N10K11R21  |
| 3495 | 2210504269 | E452I4N10K11R22  |
| 3496 | 2210504270 | E452I4N10K11R23  |
| 3497 | 2210504271 | E452I4N10K11R24  |
| 3498 | 2210504272 | E452I4N10K11R25  |
| 3499 | 2210504273 | E452I4N10K11R2A  |
| 3500 | 2210504274 | E452I4N10K11R2B  |
| 3501 | 2210504275 | E452I4N10K11R2C  |
| 3502 | 2210504276 | E452I4N10K11R2D  |
| 3503 | 2210504277 | E452I4N10K11R2E  |
| 3504 | 2210504278 | E452I4N10K11R2G  |
| 3505 | 2210504279 | E452I4N10K11R2H  |
| 3506 | 2210504280 | E452I4N10K11R2K  |
| 3507 | 2210504281 | E452I4N10K11R2L  |
| 3508 | 2210504282 | E452I4N10K11R2M  |
| 3509 | 2210504283 | E452I4N10K11S01  |
| 3510 | 2210504284 | E452I4N10K11S02  |
| 3511 | 2210504285 | E452I4N10K11S03  |
| 3512 | 2210504286 | E452I4N10K11S04  |
| 3513 | 2210504287 | E452I4N10K11S05  |
| 3514 | 2210504288 | E452I4N10K11S0A  |
| 3515 | 2210504289 | E452I4N10K11S0B  |
| 3516 | 2210504290 | E452I4N10K11S0C  |
| 3517 | 2210504291 | E452I4N10K11S0D  |
| 3518 | 2210504292 | E452I4N10K11S0E  |
| 3519 | 2210504293 | E452I4N10K11S0G  |
| 3520 | 2210504294 | E452I4N10K11S0H  |

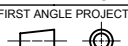
| Pos. | Molex PN:  | Engineering No.: |
|------|------------|------------------|
| 3521 | 2210504295 | E452I4N10K11S0K  |
| 3522 | 2210504296 | E452I4N10K11S0L  |
| 3523 | 2210504297 | E452I4N10K11S0M  |
| 3524 | 2210504298 | E452I4N15011000  |
| 3525 | 2210504299 | E452I4N15011A11  |
| 3526 | 2210504300 | E452I4N15011A12  |
| 3527 | 2210504301 | E452I4N15011A13  |
| 3528 | 2210504302 | E452I4N15011A14  |
| 3529 | 2210504303 | E452I4N15011A15  |
| 3530 | 2210504304 | E452I4N15011A1A  |
| 3531 | 2210504305 | E452I4N15011A1B  |
| 3532 | 2210504306 | E452I4N15011A1C  |
| 3533 | 2210504307 | E452I4N15011A1D  |
| 3534 | 2210504308 | E452I4N15011A1E  |
| 3535 | 2210504309 | E452I4N15011A1G  |
| 3536 | 2210504310 | E452I4N15011A1K  |
| 3537 | 2210504311 | E452I4N15011A1L  |
| 3538 | 2210504312 | E452I4N15011A1M  |
| 3539 | 2210504313 | E452I4N15011C31  |
| 3540 | 2210504314 | E452I4N15011C32  |
| 3541 | 2210504315 | E452I4N15011C33  |
| 3542 | 2210504316 | E452I4N15011C34  |
| 3543 | 2210504317 | E452I4N15011C35  |
| 3544 | 2210504318 | E452I4N15011C3A  |
| 3545 | 2210504319 | E452I4N15011C3B  |
| 3546 | 2210504320 | E452I4N15011C3C  |
| 3547 | 2210504321 | E452I4N15011C3D  |
| 3548 | 2210504322 | E452I4N15011C3E  |
| 3549 | 2210504323 | E452I4N15011C3G  |
| 3550 | 2210504324 | E452I4N15011C3H  |
| 3551 | 2210504325 | E452I4N15011C3K  |
| 3552 | 2210504326 | E452I4N15011C3L  |
| 3553 | 2210504327 | E452I4N15011C3M  |
| 3554 | 2210504328 | E452I4N15011C41  |
| 3555 | 2210504329 | E452I4N15011C42  |
| 3556 | 2210504330 | E452I4N15011C43  |
| 3557 | 2210504331 | E452I4N15011C44  |
| 3558 | 2210504332 | E452I4N15011C45  |
| 3559 | 2210504333 | E452I4N15011C4A  |
| 3560 | 2210504334 | E452I4N15011C4B  |

|   |  |       |  |   |  |                        |  |   |  |
|---|--|-------|--|---|--|------------------------|--|---|--|
| THIS DRAWING CONTAINS INFORMATION THAT IS PROPRIETARY TO MOLEX ELECTRONIC TECHNOLOGIES, LLC AND SHOULD NOT BE USED WITHOUT WRITTEN PERMISSION |  |       |  |   |  |                        |  |   |  |
| DIMENSION UNITS   |  | SCALE |  | CURRENT REV DESC: REVISION CREATED FOR REMOVING PRE-RELEASE STAMP |  |                        |  | <br>E452XXXXXXXXXX<br>DIN FORM A EN 175301-803 |  |
| mm  |  | NTS   |  |   |  |                        |  |   |  |
| GENERAL TOLERANCES (UNLESS SPECIFIED)   |  |       |  | EC NO: 714567   |  | 2022/07/18             |  | PRODUCT CUSTOMER DRAWING  |  |
|   |  |       |  | DRWN: SUGEEB  |  | 2022/07/19             |  |   |  |
|   |  |       |  | CHK'D: GGA  |  | 2022/07/19             |  |   |  |
|   |  |       |  | APPR: GGA   |  |                        |  |   |  |
|   |  |       |  | INITIAL REVISION:   |  |                        |  |   |  |
|   |  |       |  | DRWN: JMARSZALEK  |  | 2012/08/27             |  | DOCUMENT NUMBER   |  |
|   |  |       |  | APPR: MDYSZEWSKA  |  | 2012/08/20             |  | SD-121050-001   |  |
|   |  |       |  | DRAFT WHERE APPLICABLE MUST REMAIN WITHIN DIMENSIONS              |  | FIRST ANGLE PROJECTION |  | DOC TYPE   DOC PART   REVISION  |  |
|   |  |       |  | DRAWING   |  | SERIES                 |  | PSD   001   E1  |  |
|   |  |       |  | A3-SIZE   |  | 121050                 |  | SHEET NUMBER  |  |
|   |  |       |  | SEE TABLE   |  | GENERAL MARKET         |  | 25 OF 41  |  |

TABLE 3 - PART LIST

| Pos. | Molex PN:  | Engineering No.: |
|------|------------|------------------|
| 3561 | 2210504335 | E452I4N15011C4C  |
| 3562 | 2210504336 | E452I4N15011C4D  |
| 3563 | 2210504337 | E452I4N15011C4E  |
| 3564 | 2210504338 | E452I4N15011C4G  |
| 3565 | 2210504339 | E452I4N15011C4K  |
| 3566 | 2210504340 | E452I4N15011C4L  |
| 3567 | 2210504341 | E452I4N15011C4M  |
| 3568 | 2210504346 | E452I4N15011E05  |
| 3569 | N/A        | N/A              |
| 3570 | N/A        | N/A              |
| 3571 | N/A        | N/A              |
| 3572 | N/A        | N/A              |
| 3573 | 2210504361 | E452I4N15011R05  |
| 3574 | N/A        | N/A              |
| 3575 | N/A        | N/A              |
| 3576 | N/A        | N/A              |
| 3577 | N/A        | N/A              |
| 3578 | N/A        | N/A              |
| 3579 | N/A        | N/A              |
| 3580 | N/A        | N/A              |
| 3581 | N/A        | N/A              |
| 3582 | N/A        | N/A              |
| 3583 | N/A        | N/A              |
| 3584 | 2210504372 | E452I4N15011R21  |
| 3585 | 2210504373 | E452I4N15011R23  |
| 3586 | 2210504374 | E452I4N15011R24  |
| 3587 | 2210504375 | E452I4N15011R25  |
| 3588 | 2210504376 | E452I4N15011R2A  |
| 3589 | 2210504377 | E452I4N15011R2B  |
| 3590 | 2210504378 | E452I4N15011R2C  |
| 3591 | 2210504379 | E452I4N15011R2D  |
| 3592 | 2210504380 | E452I4N15011R2E  |
| 3593 | 2210504381 | E452I4N15011R2G  |
| 3594 | 2210504382 | E452I4N15011R2H  |
| 3595 | 2210504383 | E452I4N15011R2K  |
| 3596 | 2210504384 | E452I4N15011R2L  |
| 3597 | 2210504385 | E452I4N15011R2M  |
| 3598 | 2210504386 | E452I4N15011S01  |
| 3599 | 2210504387 | E452I4N15011S02  |
| 3600 | 2210504388 | E452I4N15011S03  |

| Pos. | Molex PN:  | Engineering No.: |
|------|------------|------------------|
| 3601 | 2210504389 | E452I4N15011S04  |
| 3602 | 2210504390 | E452I4N15011S05  |
| 3603 | 2210504391 | E452I4N15011S0A  |
| 3604 | 2210504392 | E452I4N15011S0B  |
| 3605 | 2210504393 | E452I4N15011S0C  |
| 3606 | 2210504394 | E452I4N15011S0D  |
| 3607 | 2210504395 | E452I4N15011S0E  |
| 3608 | 2210504396 | E452I4N15011S0G  |
| 3609 | 2210504397 | E452I4N15011S0H  |
| 3610 | 2210504398 | E452I4N15011S0K  |
| 3611 | 2210504399 | E452I4N15011S0L  |
| 3612 | 2210504400 | E452I4N15011S0M  |
| 3613 | 2210504401 | E452I4N20011000  |
| 3614 | 2210504402 | E452I4N20011A11  |
| 3615 | 2210504403 | E452I4N20011A12  |
| 3616 | 2210504404 | E452I4N20011A13  |
| 3617 | 2210504405 | E452I4N20011A14  |
| 3618 | 2210504406 | E452I4N20011A15  |
| 3619 | 2210504407 | E452I4N20011A1A  |
| 3620 | 2210504408 | E452I4N20011A1B  |
| 3621 | 2210504409 | E452I4N20011A1C  |
| 3622 | 2210504410 | E452I4N20011A1D  |
| 3623 | 2210504411 | E452I4N20011A1E  |
| 3624 | 2210504412 | E452I4N20011A1G  |
| 3625 | 2210504413 | E452I4N20011A1H  |
| 3626 | 2210504414 | E452I4N20011A1K  |
| 3627 | 2210504415 | E452I4N20011A1L  |
| 3628 | 2210504416 | E452I4N20011A1M  |
| 3629 | 2210504417 | E452I4N20011C31  |
| 3630 | 2210504418 | E452I4N20011C32  |
| 3631 | 2210504419 | E452I4N20011C33  |
| 3632 | 2210504420 | E452I4N20011C34  |
| 3633 | 2210504421 | E452I4N20011C35  |
| 3634 | 2210504422 | E452I4N20011C3A  |
| 3635 | 2210504423 | E452I4N20011C3C  |
| 3636 | 2210504424 | E452I4N20011C3D  |
| 3637 | 2210504425 | E452I4N20011C3E  |
| 3638 | 2210504426 | E452I4N20011C3G  |
| 3639 | 2210504427 | E452I4N20011C3K  |
| 3640 | 2210504428 | E452I4N20011C3L  |

| Pos. | Molex PN:  | Engineering No.: |
|------|------------|------------------|
| 3641 | 2210504429 | E452I4N20011C3M  |
| 3642 | 2210504430 | E452I4N20011C41  |
| 3643 | 2210504431 | E452I4N20011C42  |
| 3644 | 2210504432 | E452I4N20011C43  |
| 3645 | 2210504433 | E452I4N20011C44  |
| 3646 | 2210504434 | E452I4N20011C45  |
| 3647 | 2210504435 | E452I4N20011C4A  |
| 3648 | 2210504436 | E452I4N20011C4B  |
| 3649 | 2210504437 | E452I4N20011C4C  |
| 3650 | 2210504438 | E452I4N20011C4D  |
| 3651 | 2210504439 | E452I4N20011C4E  |
| 3652 | 2210504440 | E452I4N20011C4G  |
| 3653 | 2210504441 | E452I4N20011C4K  |
| 3654 | 2210504442 | E452I4N20011C4L  |
| 3655 | 2210504443 | E452I4N20011C4M  |
| 3656 | 2210504448 | E452I4N20011E05  |
| 3657 | N/A        | N/A              |
| 3658 | N/A        | N/A              |
| 3659 | N/A        | N/A              |
| 3660 | N/A        | N/A              |
| 3661 | 2210504463 | E452I4N20011R05  |
| 3662 | N/A        | N/A              |
| 3663 | N/A        | N/A              |
| 3664 | N/A        | N/A              |
| 3665 | N/A        | N/A              |
| 3666 | N/A        | N/A              |
| 3667 | N/A        | N/A              |
| 3668 | N/A        | N/A              |
| 3669 | N/A        | N/A              |
| 3670 | N/A        | N/A              |
| 3671 | N/A        | N/A              |
| 3672 | 2210504474 | E452I4N20011R21  |
| 3673 | 2210504475 | E452I4N20011R22  |
| 3674 | 2210504476 | E452I4N20011R23  |
| 3675 | 2210504477 | E452I4N20011R24  |
| 3676 | 2210504478 | E452I4N20011R25  |
| 3677 | 2210504479 | E452I4N20011R2A  |
| 3678 | 2210504480 | E452I4N20011R2B  |
| 3679 | 2210504481 | E452I4N20011R2C  |
| 3680 | 2210504482 | E452I4N20011R2D  |

| Pos. | Molex PN:  | Engineering No.: |
|------|------------|------------------|
| 3681 | 2210504483 | E452I4N20011R2E  |
| 3682 | 2210504484 | E452I4N20011R2G  |
| 3683 | 2210504485 | E452I4N20011R2H  |
| 3684 | 2210504486 | E452I4N20011R2K  |
| 3685 | 2210504487 | E452I4N20011R2L  |
| 3686 | 2210504488 | E452I4N20011R2M  |
| 3687 | 2210504489 | E452I4N20011S01  |
| 3688 | 2210504490 | E452I4N20011S02  |
| 3689 | 2210504491 | E452I4N20011S03  |
| 3690 | 2210504492 | E452I4N20011S04  |
| 3691 | 2210504493 | E452I4N20011S05  |
| 3692 | 2210504494 | E452I4N20011S0A  |
| 3693 | 2210504495 | E452I4N20011S0B  |
| 3694 | 2210504496 | E452I4N20011S0C  |
| 3695 | 2210504497 | E452I4N20011S0D  |
| 3696 | 2210504498 | E452I4N20011S0E  |
| 3697 | 2210504499 | E452I4N20011S0G  |
| 3698 | 2210504500 | E452I4N20011S0H  |
| 3699 | 2210504501 | E452I4N20011S0K  |
| 3700 | 2210504502 | E452I4N20011S0L  |
| 3701 | 2210504503 | E452I4N20011S0M  |
| 3702 | 2210504504 | E452I4N30011000  |
| 3703 | 2210504505 | E452I4N30011A11  |
| 3704 | 2210504506 | E452I4N30011A12  |
| 3705 | 2210504507 | E452I4N30011A13  |
| 3706 | 2210504508 | E452I4N30011A14  |
| 3707 | 2210504509 | E452I4N30011A15  |
| 3708 | 2210504510 | E452I4N30011A1A  |
| 3709 | 2210504511 | E452I4N30011A1B  |
| 3710 | 2210504512 | E452I4N30011A1C  |
| 3711 | 2210504513 | E452I4N30011A1D  |
| 3712 | 2210504514 | E452I4N30011A1E  |
| 3713 | 2210504515 | E452I4N30011A1K  |
| 3714 | 2210504516 | E452I4N30011A1L  |
| 3715 | 2210504517 | E452I4N30011A1M  |
| 3716 | 2210504518 | E452I4N30011C32  |
| 3717 | 2210504519 | E452I4N30011C33  |
| 3718 | 2210504520 | E452I4N30011C34  |
| 3719 | 2210504521 | E452I4N30011C35  |
| 3720 | 2210504522 | E452I4N30011C3A  |

|   |  |       |  |   |  |                 |  |   |  |
|---|--|-------|--|---|--|-----------------|--|---|--|
| THIS DRAWING CONTAINS INFORMATION THAT IS PROPRIETARY TO MOLEX ELECTRONIC TECHNOLOGIES, LLC AND SHOULD NOT BE USED WITHOUT WRITTEN PERMISSION |  |       |  |   |  |                 |  |   |  |
| DIMENSION UNITS   |  | SCALE |  | CURRENT REV DESC: REVISION CREATED FOR REMOVING PRE-RELEASE STAMP                     |  |                 |  | <br>E452XXXXXXXXXX<br>DIN FORM A EN 175301-803 |  |
| mm  |  | NTS   |  |   |  |                 |  |   |  |
| GENERAL TOLERANCES (UNLESS SPECIFIED)   |  |       |  | EC NO: 714567   |  | 2022/07/18      |  | PRODUCT CUSTOMER DRAWING  |  |
|   |  |       |  | DRWN: SUGEEB  |  | 2022/07/19      |  | DOCUMENT NUMBER   |  |
|   |  |       |  | CHK'D: GGA  |  | 2022/07/19      |  | SD-121050-001   |  |
|   |  |       |  | APPR: GGA   |  |                 |  | DOC TYPE DOC PART REVISION  |  |
|   |  |       |  | INITIAL REVISION:   |  |                 |  | PSD 001 E1  |  |
|   |  |       |  | DRWN: JMARSZALEK  |  | 2012/08/27      |  |   |  |
|   |  |       |  | APPR: MDYSZEWSKA  |  | 2012/08/20      |  |   |  |
| DRAFT WHERE APPLICABLE MUST REMAIN WITHIN DIMENSIONS  |  |       |  | FIRST ANGLE PROJECTION  |  | DRAWING         |  | SHEET NUMBER  |  |
|   |  |       |  |  |  | A3-SIZE         |  | 26 OF 41  |  |
|   |  |       |  | SERIES  |  | MATERIAL NUMBER |  | CUSTOMER  |  |
|   |  |       |  | 121050  |  | SEE TABLE       |  | GENERAL MARKET  |  |

TABLE 3 - PART LIST

| Pos. | Molex PN:  | Engineering No.: |
|------|------------|------------------|
| 3721 | 2210504523 | E452I4N30011C3B  |
| 3722 | 2210504524 | E452I4N30011C3C  |
| 3723 | 2210504525 | E452I4N30011C3D  |
| 3724 | 2210504526 | E452I4N30011C3E  |
| 3725 | 2210504527 | E452I4N30011C3G  |
| 3726 | 2210504528 | E452I4N30011C3K  |
| 3727 | 2210504529 | E452I4N30011C3L  |
| 3728 | 2210504530 | E452I4N30011C3M  |
| 3729 | 2210504531 | E452I4N30011C43  |
| 3730 | 2210504532 | E452I4N30011C45  |
| 3731 | 2210504533 | E452I4N30011C4A  |
| 3732 | 2210504534 | E452I4N30011C4B  |
| 3733 | 2210504535 | E452I4N30011C4C  |
| 3734 | 2210504536 | E452I4N30011C4D  |
| 3735 | 2210504537 | E452I4N30011C4E  |
| 3736 | 2210504538 | E452I4N30011C4G  |
| 3737 | 2210504539 | E452I4N30011C4K  |
| 3738 | 2210504544 | E452I4N30011E05  |
| 3739 | 2210504559 | E452I4N30011R05  |
| 3740 | 2210504570 | E452I4N30011R21  |
| 3741 | 2210504571 | E452I4N30011R22  |
| 3742 | 2210504572 | E452I4N30011R23  |
| 3743 | 2210504573 | E452I4N30011R24  |
| 3744 | 2210504574 | E452I4N30011R25  |
| 3745 | 2210504575 | E452I4N30011R2A  |
| 3746 | 2210504576 | E452I4N30011R2B  |
| 3747 | 2210504577 | E452I4N30011R2C  |
| 3748 | 2210504578 | E452I4N30011R2D  |
| 3749 | 2210504579 | E452I4N30011R2E  |
| 3750 | 2210504580 | E452I4N30011R2G  |
| 3751 | 2210504581 | E452I4N30011R2K  |
| 3752 | 2210504582 | E452I4N30011S01  |
| 3753 | 2210504583 | E452I4N30011S02  |
| 3754 | 2210504584 | E452I4N30011S03  |
| 3755 | 2210504585 | E452I4N30011S04  |
| 3756 | 2210504586 | E452I4N30011S05  |
| 3757 | 2210504587 | E452I4N30011S0A  |
| 3758 | 2210504588 | E452I4N30011S0B  |
| 3759 | 2210504589 | E452I4N30011S0C  |
| 3760 | 2210504590 | E452I4N30011S0D  |

| Pos. | Molex PN:  | Engineering No.: |
|------|------------|------------------|
| 3761 | 2210504591 | E452I4N30011S0E  |
| 3762 | 2210504592 | E452I4N30011S0G  |
| 3763 | 2210504593 | E452I4N30011S0K  |
| 3764 | 2210504594 | E452I4N30011S0L  |
| 3765 | 2210504595 | E452I4N30011S0M  |
| 3766 | 2210504596 | E452I4N50011000  |
| 3767 | 2210504597 | E452I4N50011A11  |
| 3768 | 2210504598 | E452I4N50011A12  |
| 3769 | 2210504599 | E452I4N50011A13  |
| 3770 | 2210504600 | E452I4N50011A14  |
| 3771 | 2210504601 | E452I4N50011A15  |
| 3772 | 2210504602 | E452I4N50011A1A  |
| 3773 | 2210504603 | E452I4N50011A1B  |
| 3774 | 2210504604 | E452I4N50011A1C  |
| 3775 | 2210504605 | E452I4N50011A1D  |
| 3776 | 2210504606 | E452I4N50011A1E  |
| 3777 | 2210504607 | E452I4N50011A1G  |
| 3778 | 2210504608 | E452I4N50011A1H  |
| 3779 | 2210504609 | E452I4N50011A1K  |
| 3780 | 2210504610 | E452I4N50011A1L  |
| 3781 | 2210504611 | E452I4N50011A1M  |
| 3782 | 2210504612 | E452I4N50011C31  |
| 3783 | 2210504613 | E452I4N50011C32  |
| 3784 | 2210504614 | E452I4N50011C33  |
| 3785 | 2210504615 | E452I4N50011C34  |
| 3786 | 2210504616 | E452I4N50011C35  |
| 3787 | 2210504617 | E452I4N50011C3A  |
| 3788 | 2210504618 | E452I4N50011C3C  |
| 3789 | 2210504619 | E452I4N50011C3D  |
| 3790 | 2210504620 | E452I4N50011C3E  |
| 3791 | 2210504621 | E452I4N50011C3G  |
| 3792 | 2210504622 | E452I4N50011C3K  |
| 3793 | 2210504623 | E452I4N50011C3L  |
| 3794 | 2210504624 | E452I4N50011C3M  |
| 3795 | 2210504625 | E452I4N50011C41  |
| 3796 | 2210504626 | E452I4N50011C43  |
| 3797 | 2210504627 | E452I4N50011C44  |
| 3798 | 2210504628 | E452I4N50011C45  |
| 3799 | 2210504629 | E452I4N50011C4A  |
| 3800 | 2210504630 | E452I4N50011C4B  |

| Pos. | Molex PN:  | Engineering No.: |
|------|------------|------------------|
| 3801 | 2210504631 | E452I4N50011C4C  |
| 3802 | 2210504632 | E452I4N50011C4D  |
| 3803 | 2210504633 | E452I4N50011C4E  |
| 3804 | 2210504634 | E452I4N50011C4G  |
| 3805 | 2210504635 | E452I4N50011C4K  |
| 3806 | 2210504640 | E452I4N50011E05  |
| 3807 | 2210504655 | E452I4N50011R05  |
| 3808 | 2210504666 | E452I4N50011R21  |
| 3809 | 2210504667 | E452I4N50011R22  |
| 3810 | 2210504668 | E452I4N50011R23  |
| 3811 | 2210504669 | E452I4N50011R24  |
| 3812 | 2210504670 | E452I4N50011R25  |
| 3813 | 2210504671 | E452I4N50011R2A  |
| 3814 | 2210504672 | E452I4N50011R2B  |
| 3815 | 2210504673 | E452I4N50011R2C  |
| 3816 | 2210504674 | E452I4N50011R2D  |
| 3817 | 2210504675 | E452I4N50011R2E  |
| 3818 | 2210504676 | E452I4N50011R2G  |
| 3819 | 2210504677 | E452I4N50011R2H  |
| 3820 | 2210504678 | E452I4N50011R2K  |
| 3821 | 2210504679 | E452I4N50011S01  |
| 3822 | 2210504680 | E452I4N50011S03  |
| 3823 | 2210504681 | E452I4N50011S04  |
| 3824 | 2210504682 | E452I4N50011S05  |
| 3825 | 2210504683 | E452I4N50011S0A  |
| 3826 | 2210504684 | E452I4N50011S0B  |
| 3827 | 2210504685 | E452I4N50011S0C  |
| 3828 | 2210504686 | E452I4N50011S0D  |
| 3829 | 2210504687 | E452I4N50011S0E  |
| 3830 | 2210504688 | E452I4N50011S0G  |
| 3831 | 2210504689 | E452I4N50011S0K  |
| 3832 | 2210504690 | E452I4N50011S0L  |
| 3833 | 2210504691 | E452I4N50011S0M  |
| 3834 | 2210504692 | E452N2N10011000  |
| 3835 | 2210504693 | E452N2N10011A11  |
| 3836 | 2210504694 | E452N2N10011A13  |
| 3837 | 2210504695 | E452N2N10011A14  |
| 3838 | 2210504696 | E452N2N10011A15  |
| 3839 | 2210504697 | E452N2N10011A1A  |
| 3840 | 2210504698 | E452N2N10011A1B  |

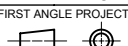
| Pos. | Molex PN:  | Engineering No.: |
|------|------------|------------------|
| 3841 | 2210504699 | E452N2N10011A1C  |
| 3842 | 2210504700 | E452N2N10011A1D  |
| 3843 | 2210504701 | E452N2N10011A1E  |
| 3844 | 2210504702 | E452N2N10011A1G  |
| 3845 | 2210504703 | E452N2N10011A1H  |
| 3846 | 2210504704 | E452N2N10011A1K  |
| 3847 | 2210504705 | E452N2N10011A1L  |
| 3848 | 2210504706 | E452N2N10011A1M  |
| 3849 | 2210504707 | E452N2N10011C31  |
| 3850 | 2210504708 | E452N2N10011C32  |
| 3851 | 2210504709 | E452N2N10011C33  |
| 3852 | 2210504710 | E452N2N10011C34  |
| 3853 | 2210504711 | E452N2N10011C35  |
| 3854 | 2210504712 | E452N2N10011C3A  |
| 3855 | 2210504713 | E452N2N10011C3B  |
| 3856 | 2210504714 | E452N2N10011C3C  |
| 3857 | 2210504715 | E452N2N10011C3D  |
| 3858 | 2210504716 | E452N2N10011C3E  |
| 3859 | 2210504717 | E452N2N10011C3G  |
| 3860 | 2210504718 | E452N2N10011C3H  |
| 3861 | 2210504719 | E452N2N10011C3K  |
| 3862 | 2210504720 | E452N2N10011C3L  |
| 3863 | 2210504721 | E452N2N10011C3M  |
| 3864 | 2210504722 | E452N2N10011C41  |
| 3865 | 2210504723 | E452N2N10011C42  |
| 3866 | 2210504724 | E452N2N10011C43  |
| 3867 | 2210504725 | E452N2N10011C44  |
| 3868 | 2210504726 | E452N2N10011C45  |
| 3869 | 2210504727 | E452N2N10011C4A  |
| 3870 | 2210504728 | E452N2N10011C4B  |
| 3871 | 2210504729 | E452N2N10011C4C  |
| 3872 | 2210504730 | E452N2N10011C4E  |
| 3873 | 2210504731 | E452N2N10011C4G  |
| 3874 | 2210504732 | E452N2N10011C4H  |
| 3875 | 2210504733 | E452N2N10011C4K  |
| 3876 | 2210504734 | E452N2N10011C4L  |
| 3877 | 2210504735 | E452N2N10011C4M  |
| 3878 | 2210504740 | E452N2N10011E05  |
| 3879 | 2210504755 | E452N2N10011R05  |
| 3880 | 2210504766 | E452N2N10011R21  |

|   |  |       |  |   |  |                |  |   |  |
|---|--|-------|--|---|--|----------------|--|---|--|
| THIS DRAWING CONTAINS INFORMATION THAT IS PROPRIETARY TO MOLEX ELECTRONIC TECHNOLOGIES, LLC AND SHOULD NOT BE USED WITHOUT WRITTEN PERMISSION |  |       |  |   |  |                |  |   |  |
| DIMENSION UNITS   |  | SCALE |  | CURRENT REV DESC: REVISION CREATED FOR REMOVING PRE-RELEASE STAMP                     |  |                |  | <br>E452XXXXXXXXXX<br>DIN FORM A EN 175301-803 |  |
| mm  |  | NTS   |  |   |  |                |  |   |  |
| GENERAL TOLERANCES (UNLESS SPECIFIED)   |  |       |  | EC NO: 714567   |  | 2022/07/18     |  | PRODUCT CUSTOMER DRAWING<br>DOCUMENT NUMBER: SD-121050-001<br>DOC TYPE: PSD<br>DOC PART: 001<br>REVISION: E1                        |  |
|   |  |       |  | DRWN: SUGEEB  |  | 2022/07/19     |  |   |  |
|   |  |       |  | CHK'D: GGA  |  | 2022/07/19     |  |   |  |
|   |  |       |  | APPR: GGA   |  |                |  |   |  |
|   |  |       |  | INITIAL REVISION:   |  |                |  |   |  |
|   |  |       |  | DRWN: JMARSZALEK  |  | 2012/08/27     |  |   |  |
|   |  |       |  | APPR: MDYSZEWSKA  |  | 2012/08/20     |  |   |  |
| DRAFT WHERE APPLICABLE MUST REMAIN WITHIN DIMENSIONS  |  |       |  | FIRST ANGLE PROJECTION  |  | DRAWING        |  | SERIES  |  |
|   |  |       |  |  |  | A3-SIZE        |  | 121050  |  |
|   |  |       |  | MATERIAL NUMBER   |  | CUSTOMER       |  | SHEET NUMBER  |  |
|   |  |       |  | SEE TABLE   |  | GENERAL MARKET |  | 27 OF 41  |  |

TABLE 3 - PART LIST

| Pos. | Molex PN:  | Engineering No.: |
|------|------------|------------------|
| 3881 | 2210504767 | E452N2N10011R22  |
| 3882 | 2210504768 | E452N2N10011R23  |
| 3883 | 2210504769 | E452N2N10011R25  |
| 3884 | 2210504770 | E452N2N10011R2A  |
| 3885 | 2210504771 | E452N2N10011R2B  |
| 3886 | 2210504772 | E452N2N10011R2C  |
| 3887 | 2210504773 | E452N2N10011R2D  |
| 3888 | 2210504774 | E452N2N10011R2E  |
| 3889 | 2210504775 | E452N2N10011R2G  |
| 3890 | 2210504776 | E452N2N10011R2K  |
| 3891 | 2210504777 | E452N2N10011R2L  |
| 3892 | 2210504778 | E452N2N10011R2M  |
| 3893 | 2210504779 | E452N2N10011S01  |
| 3894 | 2210504780 | E452N2N10011S02  |
| 3895 | 2210504781 | E452N2N10011S03  |
| 3896 | 2210504782 | E452N2N10011S04  |
| 3897 | 2210504783 | E452N2N10011S05  |
| 3898 | 2210504784 | E452N2N10011S0A  |
| 3899 | 2210504785 | E452N2N10011S0B  |
| 3900 | 2210504786 | E452N2N10011S0C  |
| 3901 | 2210504787 | E452N2N10011S0D  |
| 3902 | 2210504788 | E452N2N10011S0E  |
| 3903 | 2210504789 | E452N2N10011S0G  |
| 3904 | 2210504790 | E452N2N10011S0H  |
| 3905 | 2210504791 | E452N2N10011S0K  |
| 3906 | 2210504792 | E452N2N10011S0L  |
| 3907 | 2210504793 | E452N2N10011S0M  |
| 3908 | 2210504794 | E452N2N10K11000  |
| 3909 | 2210504795 | E452N2N10K11A11  |
| 3910 | 2210504796 | E452N2N10K11A12  |
| 3911 | 2210504797 | E452N2N10K11A13  |
| 3912 | 2210504798 | E452N2N10K11A14  |
| 3913 | 2210504799 | E452N2N10K11A15  |
| 3914 | 2210504800 | E452N2N10K11A1A  |
| 3915 | 2210504801 | E452N2N10K11A1B  |
| 3916 | 2210504802 | E452N2N10K11A1C  |
| 3917 | 2210504803 | E452N2N10K11A1D  |
| 3918 | 2210504804 | E452N2N10K11A1E  |
| 3919 | 2210504805 | E452N2N10K11A1G  |
| 3920 | 2210504806 | E452N2N10K11A1H  |

| Pos. | Molex PN:  | Engineering No.: |
|------|------------|------------------|
| 3921 | 2210504807 | E452N2N10K11A1K  |
| 3922 | 2210504808 | E452N2N10K11A1L  |
| 3923 | 2210504809 | E452N2N10K11A1M  |
| 3924 | 2210504810 | E452N2N10K11C31  |
| 3925 | 2210504811 | E452N2N10K11C32  |
| 3926 | 2210504812 | E452N2N10K11C33  |
| 3927 | 2210504813 | E452N2N10K11C34  |
| 3928 | 2210504814 | E452N2N10K11C35  |
| 3929 | 2210504815 | E452N2N10K11C3A  |
| 3930 | 2210504816 | E452N2N10K11C3B  |
| 3931 | 2210504817 | E452N2N10K11C3C  |
| 3932 | 2210504818 | E452N2N10K11C3D  |
| 3933 | 2210504819 | E452N2N10K11C3E  |
| 3934 | 2210504820 | E452N2N10K11C3G  |
| 3935 | 2210504821 | E452N2N10K11C3H  |
| 3936 | 2210504822 | E452N2N10K11C3K  |
| 3937 | 2210504823 | E452N2N10K11C3L  |
| 3938 | 2210504824 | E452N2N10K11C3M  |
| 3939 | 2210504825 | E452N2N10K11C41  |
| 3940 | 2210504826 | E452N2N10K11C43  |
| 3941 | 2210504827 | E452N2N10K11C44  |
| 3942 | 2210504828 | E452N2N10K11C45  |
| 3943 | 2210504829 | E452N2N10K11C4A  |
| 3944 | 2210504830 | E452N2N10K11C4B  |
| 3945 | 2210504831 | E452N2N10K11C4C  |
| 3946 | 2210504832 | E452N2N10K11C4D  |
| 3947 | 2210504833 | E452N2N10K11C4E  |
| 3948 | 2210504834 | E452N2N10K11C4G  |
| 3949 | 2210504835 | E452N2N10K11C4H  |
| 3950 | 2210504836 | E452N2N10K11C4K  |
| 3951 | 2210504837 | E452N2N10K11C4L  |
| 3952 | 2210504838 | E452N2N10K11C4M  |
| 3953 | 2210504843 | E452N2N10K11E05  |
| 3954 | 2210504858 | E452N2N10K11R05  |
| 3955 | 2210504869 | E452N2N10K11R21  |
| 3956 | 2210504870 | E452N2N10K11R22  |
| 3957 | 2210504871 | E452N2N10K11R23  |
| 3958 | 2210504872 | E452N2N10K11R24  |
| 3959 | 2210504873 | E452N2N10K11R25  |
| 3960 | 2210504874 | E452N2N10K11R2A  |

| Pos. | Molex PN:  | Engineering No.: |
|------|------------|------------------|
| 3961 | 2210504875 | E452N2N10K11R2B  |
| 3962 | 2210504876 | E452N2N10K11R2C  |
| 3963 | 2210504877 | E452N2N10K11R2D  |
| 3964 | 2210504878 | E452N2N10K11R2E  |
| 3965 | 2210504879 | E452N2N10K11R2G  |
| 3966 | 2210504880 | E452N2N10K11R2H  |
| 3967 | 2210504881 | E452N2N10K11R2K  |
| 3968 | 2210504882 | E452N2N10K11R2L  |
| 3969 | 2210504883 | E452N2N10K11R2M  |
| 3970 | 2210504884 | E452N2N10K11S01  |
| 3971 | 2210504885 | E452N2N10K11S02  |
| 3972 | 2210504886 | E452N2N10K11S03  |
| 3973 | 2210504887 | E452N2N10K11S04  |
| 3974 | 2210504888 | E452N2N10K11S05  |
| 3975 | 2210504889 | E452N2N10K11S0A  |
| 3976 | 2210504890 | E452N2N10K11S0B  |
| 3977 | 2210504891 | E452N2N10K11S0C  |
| 3978 | 2210504892 | E452N2N10K11S0D  |
| 3979 | 2210504893 | E452N2N10K11S0E  |
| 3980 | 2210504894 | E452N2N10K11S0G  |
| 3981 | 2210504895 | E452N2N10K11S0H  |
| 3982 | 2210504896 | E452N2N10K11S0K  |
| 3983 | 2210504897 | E452N2N10K11S0L  |
| 3984 | 2210504898 | E452N2N10K11S0M  |
| 3985 | 2210504899 | E452N2N15011000  |
| 3986 | 2210504900 | E452N2N15011A11  |
| 3987 | 2210504901 | E452N2N15011A12  |
| 3988 | 2210504902 | E452N2N15011A13  |
| 3989 | 2210504903 | E452N2N15011A14  |
| 3990 | 2210504904 | E452N2N15011A15  |
| 3991 | 2210504905 | E452N2N15011A1A  |
| 3992 | 2210504906 | E452N2N15011A1B  |
| 3993 | 2210504907 | E452N2N15011A1C  |
| 3994 | 2210504908 | E452N2N15011A1D  |
| 3995 | 2210504909 | E452N2N15011A1E  |
| 3996 | 2210504910 | E452N2N15011A1G  |
| 3997 | 2210504911 | E452N2N15011A1H  |
| 3998 | 2210504912 | E452N2N15011A1K  |
| 3999 | 2210504913 | E452N2N15011A1L  |
| 4000 | 2210504914 | E452N2N15011A1M  |

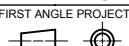
| Pos. | Molex PN:  | Engineering No.: |
|------|------------|------------------|
| 4001 | 2210504915 | E452N2N15011C31  |
| 4002 | 2210504916 | E452N2N15011C32  |
| 4003 | 2210504917 | E452N2N15011C33  |
| 4004 | 2210504918 | E452N2N15011C34  |
| 4005 | 2210504919 | E452N2N15011C35  |
| 4006 | 2210504920 | E452N2N15011C3A  |
| 4007 | 2210504921 | E452N2N15011C3B  |
| 4008 | 2210504922 | E452N2N15011C3C  |
| 4009 | 2210504923 | E452N2N15011C3D  |
| 4010 | 2210504924 | E452N2N15011C3E  |
| 4011 | 2210504925 | E452N2N15011C3G  |
| 4012 | 2210504926 | E452N2N15011C3H  |
| 4013 | 2210504927 | E452N2N15011C3K  |
| 4014 | 2210504928 | E452N2N15011C3L  |
| 4015 | 2210504929 | E452N2N15011C3M  |
| 4016 | 2210504930 | E452N2N15011C41  |
| 4017 | 2210504931 | E452N2N15011C43  |
| 4018 | 2210504932 | E452N2N15011C44  |
| 4019 | 2210504933 | E452N2N15011C45  |
| 4020 | 2210504934 | E452N2N15011C4A  |
| 4021 | 2210504935 | E452N2N15011C4C  |
| 4022 | 2210504936 | E452N2N15011C4D  |
| 4023 | 2210504937 | E452N2N15011C4E  |
| 4024 | 2210504938 | E452N2N15011C4G  |
| 4025 | 2210504939 | E452N2N15011C4H  |
| 4026 | 2210504940 | E452N2N15011C4K  |
| 4027 | 2210504941 | E452N2N15011C4L  |
| 4028 | 2210504942 | E452N2N15011C4M  |
| 4029 | 2210504961 | E452N2N15011R05  |
| 4030 | 2210504972 | E452N2N15011R21  |
| 4031 | 2210504973 | E452N2N15011R22  |
| 4032 | 2210504974 | E452N2N15011R23  |
| 4033 | 2210504975 | E452N2N15011R24  |
| 4034 | 2210504976 | E452N2N15011R25  |
| 4035 | 2210504977 | E452N2N15011R2A  |
| 4036 | 2210504978 | E452N2N15011R2B  |
| 4037 | 2210504979 | E452N2N15011R2C  |
| 4038 | 2210504980 | E452N2N15011R2D  |
| 4039 | 2210504981 | E452N2N15011R2E  |
| 4040 | 2210504982 | E452N2N15011R2G  |

|   |  |   |  |   |  |                             |  |   |  |
|---|--|---|--|---|--|-----------------------------|--|---|--|
| THIS DRAWING CONTAINS INFORMATION THAT IS PROPRIETARY TO MOLEX ELECTRONIC TECHNOLOGIES, LLC AND SHOULD NOT BE USED WITHOUT WRITTEN PERMISSION |  |   |  |   |  |                             |  |   |  |
| DIMENSION UNITS   |  | SCALE   |  | CURRENT REV DESC: REVISION CREATED FOR REMOVING PRE-RELEASE STAMP |  |                             |  | <br>E452XXXXXXXXXX<br>DIN FORM A EN 175301-803 |  |
| mm  |  | NTS   |  |   |  |                             |  |   |  |
| GENERAL TOLERANCES (UNLESS SPECIFIED)   |  |   |  |   |  |                             |  |   |  |
|   |  | MM  |  | INCH  |  |                             |  |   |  |
| 4 PLACES  |  | ±   |  | ±   |  | EC NO: 714567               |  |   |  |
| 3 PLACES  |  | ±   |  | ±   |  | DRWN: SUGEEB 2022/07/18     |  |   |  |
| 2 PLACES  |  | ±   |  | ±   |  | CHK'D: GGA 2022/07/19       |  |   |  |
| 1 PLACE   |  | ±   |  | ±   |  | APPR: GGA 2022/07/19        |  |   |  |
| 0 PLACES  |  | ±   |  | ±   |  | INITIAL REVISION:           |  |   |  |
| ANGULAR TOL   |  | ± °   |  | ± °   |  | DRWN: JMARSZALEK 2012/08/27 |  |   |  |
|   |  |   |  |   |  | APPR: MDYSZEWSKA 2012/08/20 |  |   |  |
| DRAFT WHERE APPLICABLE MUST REMAIN WITHIN DIMENSIONS  |  | FIRST ANGLE PROJECTION  |  | DRAWING   |  | SERIES                      |  | SHEET NUMBER  |  |
|   |  |  |  | A3-SIZE   |  | 121050                      |  | 28 OF 41  |  |
|   |  | SEE TABLE   |  | GENERAL MARKET  |  | DOCUMENT NUMBER             |  | REVISION  |  |
|   |  |   |  |   |  | SD-121050-001               |  | E1  |  |



TABLE 3 - PART LIST

| Pos. | Molex PN:  | Engineering No.: |
|------|------------|------------------|
| 4041 | 2210504983 | E452N2N15011R2H  |
| 4042 | 2210504984 | E452N2N15011R2K  |
| 4043 | 2210504985 | E452N2N15011R2L  |
| 4044 | 2210504986 | E452N2N15011R2M  |
| 4045 | 2210504987 | E452N2N15011S01  |
| 4046 | 2210504988 | E452N2N15011S02  |
| 4047 | 2210504989 | E452N2N15011S03  |
| 4048 | 2210504990 | E452N2N15011S04  |
| 4049 | 2210504991 | E452N2N15011S05  |
| 4050 | 2210504992 | E452N2N15011S0A  |
| 4051 | 2210504993 | E452N2N15011S0B  |
| 4052 | 2210504994 | E452N2N15011S0C  |
| 4053 | 2210504995 | E452N2N15011S0D  |
| 4054 | 2210504996 | E452N2N15011S0E  |
| 4055 | 2210504997 | E452N2N15011S0G  |
| 4056 | 2210504998 | E452N2N15011S0H  |
| 4057 | 2210504999 | E452N2N15011S0K  |
| 4058 | 2210505000 | E452N2N15011S0L  |
| 4059 | 2210505001 | E452N2N15011S0M  |
| 4060 | 2210505002 | E452N2N20011000  |
| 4061 | 2210505003 | E452N2N20011A12  |
| 4062 | 2210505004 | E452N2N20011A13  |
| 4063 | 2210505005 | E452N2N20011A14  |
| 4064 | 2210505006 | E452N2N20011A15  |
| 4065 | 2210505007 | E452N2N20011A1A  |
| 4066 | 2210505008 | E452N2N20011A1B  |
| 4067 | 2210505009 | E452N2N20011A1C  |
| 4068 | 2210505010 | E452N2N20011A1D  |
| 4069 | 2210505011 | E452N2N20011A1E  |
| 4070 | 2210505012 | E452N2N20011A1G  |
| 4071 | 2210505013 | E452N2N20011A1K  |
| 4072 | 2210505014 | E452N2N20011A1L  |
| 4073 | 2210505015 | E452N2N20011A1M  |
| 4074 | 2210505016 | E452N2N20011C31  |
| 4075 | 2210505017 | E452N2N20011C32  |
| 4076 | 2210505018 | E452N2N20011C33  |
| 4077 | 2210505019 | E452N2N20011C34  |
| 4078 | 2210505020 | E452N2N20011C35  |
| 4079 | 2210505021 | E452N2N20011C3A  |
| 4080 | 2210505022 | E452N2N20011C3B  |

| Pos. | Molex PN:  | Engineering No.: |
|------|------------|------------------|
| 4081 | 2210505023 | E452N2N20011C3C  |
| 4082 | 2210505024 | E452N2N20011C3D  |
| 4083 | 2210505025 | E452N2N20011C3E  |
| 4084 | 2210505026 | E452N2N20011C3G  |
| 4085 | 2210505027 | E452N2N20011C3H  |
| 4086 | 2210505028 | E452N2N20011C3K  |
| 4087 | 2210505029 | E452N2N20011C3L  |
| 4088 | 2210505030 | E452N2N20011C3M  |
| 4089 | 2210505031 | E452N2N20011C41  |
| 4090 | 2210505032 | E452N2N20011C43  |
| 4091 | 2210505033 | E452N2N20011C44  |
| 4092 | 2210505034 | E452N2N20011C45  |
| 4093 | 2210505035 | E452N2N20011C4A  |
| 4094 | 2210505036 | E452N2N20011C4B  |
| 4095 | 2210505037 | E452N2N20011C4C  |
| 4096 | 2210505038 | E452N2N20011C4D  |
| 4097 | 2210505039 | E452N2N20011C4E  |
| 4098 | 2210505040 | E452N2N20011C4G  |
| 4099 | 2210505041 | E452N2N20011C4K  |
| 4100 | 2210505042 | E452N2N20011C4L  |
| 4101 | 2210505043 | E452N2N20011C4M  |
| 4102 | 2210505062 | E452N2N20011R05  |
| 4103 | 2210505073 | E452N2N20011R21  |
| 4104 | 2210505074 | E452N2N20011R22  |
| 4105 | 2210505075 | E452N2N20011R23  |
| 4106 | 2210505076 | E452N2N20011R24  |
| 4107 | 2210505077 | E452N2N20011R25  |
| 4108 | 2210505078 | E452N2N20011R2A  |
| 4109 | 2210505079 | E452N2N20011R2B  |
| 4110 | 2210505080 | E452N2N20011R2C  |
| 4111 | 2210505081 | E452N2N20011R2D  |
| 4112 | 2210505082 | E452N2N20011R2E  |
| 4113 | 2210505083 | E452N2N20011R2G  |
| 4114 | 2210505084 | E452N2N20011R2H  |
| 4115 | 2210505085 | E452N2N20011R2K  |
| 4116 | 2210505086 | E452N2N20011R2L  |
| 4117 | 2210505087 | E452N2N20011R2M  |
| 4118 | 2210505088 | E452N2N20011S01  |
| 4119 | 2210505089 | E452N2N20011S02  |
| 4120 | 2210505090 | E452N2N20011S03  |

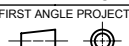
| Pos. | Molex PN:  | Engineering No.: |
|------|------------|------------------|
| 3641 | 2210504429 | E452I4N20011C3M  |
| 3642 | 2210504430 | E452I4N20011C41  |
| 3643 | 2210504431 | E452I4N20011C42  |
| 3644 | 2210504432 | E452I4N20011C43  |
| 3645 | 2210504433 | E452I4N20011C44  |
| 3646 | 2210504434 | E452I4N20011C45  |
| 3647 | 2210504435 | E452I4N20011C4A  |
| 3648 | 2210504436 | E452I4N20011C4B  |
| 3649 | 2210504437 | E452I4N20011C4C  |
| 3650 | 2210504438 | E452I4N20011C4D  |
| 3651 | 2210504439 | E452I4N20011C4E  |
| 3652 | 2210504440 | E452I4N20011C4G  |
| 3653 | 2210504441 | E452I4N20011C4K  |
| 3654 | 2210504442 | E452I4N20011C4L  |
| 3655 | 2210504443 | E452I4N20011C4M  |
| 3656 | 2210504448 | E452I4N20011E05  |
| 3657 | 2210504459 | E452I4N20011R01  |
| 3658 | 2210504460 | E452I4N20011R02  |
| 3659 | 2210504461 | E452I4N20011R03  |
| 3660 | 2210504462 | E452I4N20011R04  |
| 3661 | 2210504463 | E452I4N20011R05  |
| 3662 | 2210504464 | E452I4N20011R0A  |
| 3663 | 2210504465 | E452I4N20011R0B  |
| 3664 | 2210504466 | E452I4N20011R0C  |
| 3665 | 2210504467 | E452I4N20011R0D  |
| 3666 | 2210504468 | E452I4N20011R0E  |
| 3667 | 2210504469 | E452I4N20011R0G  |
| 3668 | 2210504470 | E452I4N20011R0H  |
| 3669 | 2210504471 | E452I4N20011R0K  |
| 3670 | 2210504472 | E452I4N20011R0L  |
| 3671 | 2210504473 | E452I4N20011R0M  |
| 3672 | 2210504474 | E452I4N20011R21  |
| 3673 | 2210504475 | E452I4N20011R22  |
| 3674 | 2210504476 | E452I4N20011R23  |
| 3675 | 2210504477 | E452I4N20011R24  |
| 3676 | 2210504478 | E452I4N20011R25  |
| 3677 | 2210504479 | E452I4N20011R2A  |
| 3678 | 2210504480 | E452I4N20011R2B  |
| 3679 | 2210504481 | E452I4N20011R2C  |
| 3680 | 2210504482 | E452I4N20011R2D  |

| Pos. | Molex PN:  | Engineering No.: |
|------|------------|------------------|
| 4121 | 2210505091 | E452N2N20011S04  |
| 4122 | 2210505092 | E452N2N20011S05  |
| 4123 | 2210505093 | E452N2N20011S0A  |
| 4124 | 2210505094 | E452N2N20011S0B  |
| 4125 | 2210505095 | E452N2N20011S0C  |
| 4126 | 2210505096 | E452N2N20011S0D  |
| 4127 | 2210505097 | E452N2N20011S0E  |
| 4128 | 2210505098 | E452N2N20011S0G  |
| 4129 | 2210505099 | E452N2N20011S0H  |
| 4130 | 2210505100 | E452N2N20011S0K  |
| 4131 | 2210505101 | E452N2N20011S0L  |
| 4132 | 2210505102 | E452N2N20011S0M  |
| 4133 | 2210505103 | E452N2N30011000  |
| 4134 | 2210505104 | E452N2N30011A13  |
| 4135 | 2210505105 | E452N2N30011A15  |
| 4136 | 2210505106 | E452N2N30011A1A  |
| 4137 | 2210505107 | E452N2N30011A1B  |
| 4138 | 2210505108 | E452N2N30011A1C  |
| 4139 | 2210505109 | E452N2N30011A1E  |
| 4140 | 2210505110 | E452N2N30011A1G  |
| 4141 | 2210505111 | E452N2N30011A1K  |
| 4142 | 2210505112 | E452N2N30011A1L  |
| 4143 | 2210505113 | E452N2N30011C32  |
| 4144 | 2210505114 | E452N2N30011C33  |
| 4145 | 2210505115 | E452N2N30011C34  |
| 4146 | 2210505116 | E452N2N30011C35  |
| 4147 | 2210505117 | E452N2N30011C3A  |
| 4148 | 2210505118 | E452N2N30011C3B  |
| 4149 | 2210505119 | E452N2N30011C3C  |
| 4150 | 2210505120 | E452N2N30011C3D  |
| 4151 | 2210505121 | E452N2N30011C3E  |
| 4152 | 2210505122 | E452N2N30011C3G  |
| 4153 | 2210505123 | E452N2N30011C3K  |
| 4154 | 2210505124 | E452N2N30011C3L  |
| 4155 | 2210505125 | E452N2N30011C3M  |
| 4156 | 2210505126 | E452N2N30011C41  |
| 4157 | 2210505127 | E452N2N30011C43  |
| 4158 | 2210505128 | E452N2N30011C4A  |
| 4159 | 2210505129 | E452N2N30011C4B  |
| 4160 | 2210505130 | E452N2N30011C4C  |

|   |  |       |      |   |  |         |  |        |  |   |  |
|---|--|-------|------|---|--|---------|--|--------|--|---|--|
| THIS DRAWING CONTAINS INFORMATION THAT IS PROPRIETARY TO MOLEX ELECTRONIC TECHNOLOGIES, LLC AND SHOULD NOT BE USED WITHOUT WRITTEN PERMISSION |  |       |      |   |  |         |  |        |  |   |  |
| DIMENSION UNITS   |  | SCALE |      | CURRENT REV DESC: REVISION CREATED FOR REMOVING PRE-RELEASE STAMP                     |  |         |  |        |  |  |  |
| mm  |  | NTS   |      |   |  |         |  |        |  |   |  |
| GENERAL TOLERANCES (UNLESS SPECIFIED)   |  |       |      |   |  |         |  |        |  |   |  |
|   |  | MM    | INCH |   |  |         |  |        |  |   |  |
| 4 PLACES  |  | ±     | ±    |   |  |         |  |        |  |   |  |
| 3 PLACES  |  | ±     | ±    |   |  |         |  |        |  |   |  |
| 2 PLACES  |  | ±     | ±    |   |  |         |  |        |  |   |  |
| 1 PLACE   |  | ±     | ±    |   |  |         |  |        |  |   |  |
| 0 PLACES  |  | ±     | ±    |   |  |         |  |        |  |   |  |
| ANGULAR TOL   |  | ±     | °    |   |  |         |  |        |  |   |  |
| DRAFT WHERE APPLICABLE MUST REMAIN WITHIN DIMENSIONS  |  |       |      | FIRST ANGLE PROJECTION  |  | DRAWING |  | SERIES |  | SHEET NUMBER  |  |
|   |  |       |      |  |  | A3-SIZE |  | 121050 |  | 29 OF 41  |  |



TABLE 3 - PART LIST

| Pos. | Molex PN:  | Engineering No.: |
|------|------------|------------------|
| 4161 | 2210505131 | E452N2N30011C4D  |
| 4162 | 2210505132 | E452N2N30011C4E  |
| 4163 | 2210505133 | E452N2N30011C4G  |
| 4164 | 2210505134 | E452N2N30011C4H  |
| 4165 | 2210505135 | E452N2N30011C4K  |
| 4166 | 2210505136 | E452N2N30011C4L  |
| 4167 | 2210505141 | E452N2N30011E05  |
| 4168 | 2210505166 | E452N2N30011R21  |
| 4169 | 2210505167 | E452N2N30011R22  |
| 4170 | 2210505168 | E452N2N30011R23  |
| 4171 | 2210505169 | E452N2N30011R24  |
| 4172 | 2210505170 | E452N2N30011R25  |
| 4173 | 2210505171 | E452N2N30011R2A  |
| 4174 | 2210505172 | E452N2N30011R2C  |
| 4175 | 2210505173 | E452N2N30011R2D  |
| 4176 | 2210505174 | E452N2N30011R2E  |
| 4177 | 2210505175 | E452N2N30011R2G  |
| 4178 | 2210505176 | E452N2N30011R2H  |
| 4179 | 2210505177 | E452N2N30011R2K  |
| 4180 | 2210505178 | E452N2N30011R2L  |
| 4181 | 2210505179 | E452N2N30011S01  |
| 4182 | 2210505180 | E452N2N30011S02  |
| 4183 | 2210505181 | E452N2N30011S03  |
| 4184 | 2210505182 | E452N2N30011S04  |
| 4185 | 2210505183 | E452N2N30011S05  |
| 4186 | 2210505184 | E452N2N30011S0A  |
| 4187 | 2210505185 | E452N2N30011S0B  |
| 4188 | 2210505186 | E452N2N30011S0C  |
| 4189 | 2210505187 | E452N2N30011S0D  |
| 4190 | 2210505188 | E452N2N30011S0E  |
| 4191 | 2210505189 | E452N2N30011S0G  |
| 4192 | 2210505190 | E452N2N30011S0H  |
| 4193 | 2210505191 | E452N2N30011S0K  |
| 4194 | 2210505192 | E452N2N30011S0L  |
| 4195 | 2210505193 | E452N2N30011S0M  |
| 4196 | 2210505194 | E452N2N50011000  |
| 4197 | 2210505195 | E452N2N50011A11  |
| 4198 | 2210505196 | E452N2N50011A12  |
| 4199 | 2210505197 | E452N2N50011A13  |
| 4200 | 2210505198 | E452N2N50011A14  |

| Pos. | Molex PN:  | Engineering No.: |
|------|------------|------------------|
| 4201 | 2210505199 | E452N2N50011A15  |
| 4202 | 2210505200 | E452N2N50011A1A  |
| 4203 | 2210505201 | E452N2N50011A1B  |
| 4204 | 2210505202 | E452N2N50011A1C  |
| 4205 | 2210505203 | E452N2N50011A1D  |
| 4206 | 2210505204 | E452N2N50011A1E  |
| 4207 | 2210505205 | E452N2N50011A1G  |
| 4208 | 2210505206 | E452N2N50011A1H  |
| 4209 | 2210505207 | E452N2N50011A1K  |
| 4210 | 2210505208 | E452N2N50011A1L  |
| 4211 | 2210505209 | E452N2N50011A1M  |
| 4212 | 2210505210 | E452N2N50011C31  |
| 4213 | 2210505211 | E452N2N50011C32  |
| 4214 | 2210505212 | E452N2N50011C33  |
| 4215 | 2210505213 | E452N2N50011C34  |
| 4216 | 2210505214 | E452N2N50011C35  |
| 4217 | 2210505215 | E452N2N50011C3A  |
| 4218 | 2210505216 | E452N2N50011C3B  |
| 4219 | 2210505217 | E452N2N50011C3C  |
| 4220 | 2210505218 | E452N2N50011C3D  |
| 4221 | 2210505219 | E452N2N50011C3E  |
| 4222 | 2210505220 | E452N2N50011C3G  |
| 4223 | 2210505221 | E452N2N50011C3H  |
| 4224 | 2210505222 | E452N2N50011C3K  |
| 4225 | 2210505223 | E452N2N50011C3L  |
| 4226 | 2210505224 | E452N2N50011C3M  |
| 4227 | 2210505225 | E452N2N50011C41  |
| 4228 | 2210505226 | E452N2N50011C42  |
| 4229 | 2210505227 | E452N2N50011C43  |
| 4230 | 2210505228 | E452N2N50011C44  |
| 4231 | 2210505229 | E452N2N50011C45  |
| 4232 | 2210505230 | E452N2N50011C4A  |
| 4233 | 2210505231 | E452N2N50011C4B  |
| 4234 | 2210505232 | E452N2N50011C4C  |
| 4235 | 2210505233 | E452N2N50011C4D  |
| 4236 | 2210505234 | E452N2N50011C4E  |
| 4237 | 2210505235 | E452N2N50011C4G  |
| 4238 | 2210505236 | E452N2N50011C4K  |
| 4239 | 2210505237 | E452N2N50011C4L  |
| 4240 | 2210505238 | E452N2N50011C4M  |

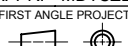
| Pos. | Molex PN:  | Engineering No.: |
|------|------------|------------------|
| 4241 | 2210505243 | E452N2N50011E05  |
| 4242 | 2210505244 | E452N2N50011E0A  |
| 4243 | 2210505245 | E452N2N50011E0B  |
| 4244 | 2210505246 | E452N2N50011E0C  |
| 4245 | 2210505247 | E452N2N50011E0D  |
| 4246 | 2210505248 | E452N2N50011E0E  |
| 4247 | 2210505249 | E452N2N50011E0G  |
| 4248 | 2210505250 | E452N2N50011E0H  |
| 4249 | 2210505251 | E452N2N50011E0K  |
| 4250 | 2210505252 | E452N2N50011E0L  |
| 4251 | 2210505253 | E452N2N50011E0M  |
| 4252 | 2210505258 | E452N2N50011R05  |
| 4253 | 2210505269 | E452N2N50011R21  |
| 4254 | 2210505270 | E452N2N50011R22  |
| 4255 | 2210505271 | E452N2N50011R23  |
| 4256 | 2210505272 | E452N2N50011R24  |
| 4257 | 2210505273 | E452N2N50011R25  |
| 4258 | 2210505274 | E452N2N50011R2A  |
| 4259 | 2210505275 | E452N2N50011R2B  |
| 4260 | 2210505276 | E452N2N50011R2C  |
| 4261 | 2210505277 | E452N2N50011R2D  |
| 4262 | 2210505278 | E452N2N50011R2E  |
| 4263 | 2210505279 | E452N2N50011R2G  |
| 4264 | 2210505280 | E452N2N50011R2H  |
| 4265 | 2210505281 | E452N2N50011R2K  |
| 4266 | 2210505282 | E452N2N50011R2L  |
| 4267 | 2210505283 | E452N2N50011R2M  |
| 4268 | 2210505284 | E452N2N50011S01  |
| 4269 | 2210505285 | E452N2N50011S02  |
| 4270 | 2210505286 | E452N2N50011S03  |
| 4271 | 2210505287 | E452N2N50011S04  |
| 4272 | 2210505288 | E452N2N50011S05  |
| 4273 | 2210505289 | E452N2N50011S0A  |
| 4274 | 2210505290 | E452N2N50011S0B  |
| 4275 | 2210505291 | E452N2N50011S0C  |
| 4276 | 2210505292 | E452N2N50011S0D  |
| 4277 | 2210505293 | E452N2N50011S0E  |
| 4278 | 2210505294 | E452N2N50011S0G  |
| 4279 | 2210505295 | E452N2N50011S0H  |
| 4280 | 2210505296 | E452N2N50011S0K  |

| Pos. | Molex PN:  | Engineering No.: |
|------|------------|------------------|
| 4281 | 2210505297 | E452N2N50011S0L  |
| 4282 | 2210505298 | E452N2N50011S0M  |
| 4283 | 2210505299 | E452N3N10011A13  |
| 4284 | 2210505300 | E452N3N10011A14  |
| 4285 | 2210505301 | E452N3N10011A15  |
| 4286 | 2210505302 | E452N3N10011A1A  |
| 4287 | 2210505303 | E452N3N10011A1B  |
| 4288 | 2210505304 | E452N3N10011A1C  |
| 4289 | 2210505305 | E452N3N10011A1D  |
| 4290 | 2210505306 | E452N3N10011A1E  |
| 4291 | 2210505307 | E452N3N10011A1G  |
| 4292 | 2210505308 | E452N3N10011A1H  |
| 4293 | 2210505309 | E452N3N10011A1K  |
| 4294 | 2210505310 | E452N3N10011A1L  |
| 4295 | 2210505311 | E452N3N10011A1M  |
| 4296 | 2210505312 | E452N3N10011C31  |
| 4297 | 2210505313 | E452N3N10011C32  |
| 4298 | 2210505314 | E452N3N10011C33  |
| 4299 | 2210505315 | E452N3N10011C34  |
| 4300 | 2210505316 | E452N3N10011C35  |
| 4301 | 2210505317 | E452N3N10011C3A  |
| 4302 | 2210505318 | E452N3N10011C3B  |
| 4303 | 2210505319 | E452N3N10011C3C  |
| 4304 | 2210505320 | E452N3N10011C3D  |
| 4305 | 2210505321 | E452N3N10011C3E  |
| 4306 | 2210505322 | E452N3N10011C3H  |
| 4307 | 2210505323 | E452N3N10011C3K  |
| 4308 | 2210505324 | E452N3N10011C3L  |
| 4309 | 2210505325 | E452N3N10011C3M  |
| 4310 | 2210505326 | E452N3N10011C43  |
| 4311 | 2210505327 | E452N3N10011C44  |
| 4312 | 2210505328 | E452N3N10011C4A  |
| 4313 | 2210505329 | E452N3N10011C4C  |
| 4314 | 2210505330 | E452N3N10011C4D  |
| 4315 | 2210505331 | E452N3N10011C4E  |
| 4316 | 2210505332 | E452N3N10011C4G  |
| 4317 | 2210505333 | E452N3N10011C4K  |
| 4318 | 2210505338 | E452N3N10011E05  |
| 4319 | 2210505353 | E452N3N10011R05  |
| 4320 | 2210505364 | E452N3N10011R21  |

|   |  |       |  |   |  |            |  |   |  |
|---|--|-------|--|---|--|------------|--|---|--|
| THIS DRAWING CONTAINS INFORMATION THAT IS PROPRIETARY TO MOLEX ELECTRONIC TECHNOLOGIES, LLC AND SHOULD NOT BE USED WITHOUT WRITTEN PERMISSION |  |       |  |   |  |            |  |   |  |
| DIMENSION UNITS   |  | SCALE |  | CURRENT REV DESC: REVISION CREATED FOR REMOVING PRE-RELEASE STAMP                     |  |            |  | <br>E452XXXXXXXXXX<br>DIN FORM A EN 175301-803 |  |
| mm  |  | NTS   |  |   |  |            |  |   |  |
| GENERAL TOLERANCES (UNLESS SPECIFIED)   |  |       |  |   |  |            |  |   |  |
|   |  | MM    |  | INCH  |  |            |  |   |  |
| 4 PLACES  |  | ±     |  | ±   |  |            |  |   |  |
| 3 PLACES  |  | ±     |  | ±   |  |            |  |   |  |
| 2 PLACES  |  | ±     |  | ±   |  |            |  |   |  |
| 1 PLACE   |  | ±     |  | ±   |  |            |  |   |  |
| 0 PLACES  |  | ±     |  | ±   |  |            |  |   |  |
| ANGULAR TOL   |  | ± °   |  |   |  |            |  |   |  |
| DRAFT WHERE APPLICABLE MUST REMAIN WITHIN DIMENSIONS  |  |       |  | FIRST ANGLE PROJECTION  |  | DRAWING    |  | SERIES  |  |
|   |  |       |  |  |  | A3-SIZE    |  | 121050  |  |
| DOCUMENT STATUS   |  | P1    |  | RELEASE DATE  |  | 2022/07/19 |  | 09:04:35  |  |
|   |  | 9     |  | 8   |  | 7          |  | 6   |  |
|   |  | 5     |  | 4   |  | 3          |  | 2   |  |
|   |  | 1     |  |   |  |            |  |   |  |

TABLE 3 - PART LIST

| Pos. | Molex PN:  | Engineering No.: |
|------|------------|------------------|
| 4321 | 2210505365 | E452N3N10011R22  |
| 4322 | 2210505366 | E452N3N10011R23  |
| 4323 | 2210505367 | E452N3N10011R24  |
| 4324 | 2210505368 | E452N3N10011R25  |
| 4325 | 2210505369 | E452N3N10011R2A  |
| 4326 | 2210505370 | E452N3N10011R2B  |
| 4327 | 2210505371 | E452N3N10011R2C  |
| 4328 | 2210505372 | E452N3N10011R2D  |
| 4329 | 2210505373 | E452N3N10011R2E  |
| 4330 | 2210505374 | E452N3N10011R2G  |
| 4331 | 2210505375 | E452N3N10011R2K  |
| 4332 | 2210505376 | E452N3N10011R2L  |
| 4333 | 2210505377 | E452N3N10011R2M  |
| 4334 | 2210505378 | E452N3N10011S01  |
| 4335 | 2210505379 | E452N3N10011S02  |
| 4336 | 2210505380 | E452N3N10011S03  |
| 4337 | 2210505381 | E452N3N10011S04  |
| 4338 | 2210505382 | E452N3N10011S05  |
| 4339 | 2210505383 | E452N3N10011S0A  |
| 4340 | 2210505384 | E452N3N10011S0B  |
| 4341 | 2210505385 | E452N3N10011S0C  |
| 4342 | 2210505386 | E452N3N10011S0D  |
| 4343 | 2210505387 | E452N3N10011S0E  |
| 4344 | 2210505388 | E452N3N10011S0G  |
| 4345 | 2210505389 | E452N3N10011S0H  |
| 4346 | 2210505390 | E452N3N10011S0K  |
| 4347 | 2210505391 | E452N3N10011S0L  |
| 4348 | 2210505392 | E452N3N10011S0M  |
| 4349 | 2210505393 | E452N3N10K11000  |
| 4350 | 2210505394 | E452N3N10K11A11  |
| 4351 | 2210505395 | E452N3N10K11A12  |
| 4352 | 2210505396 | E452N3N10K11A13  |
| 4353 | 2210505397 | E452N3N10K11A14  |
| 4354 | 2210505398 | E452N3N10K11A15  |
| 4355 | 2210505399 | E452N3N10K11A1A  |
| 4356 | 2210505400 | E452N3N10K11A1B  |
| 4357 | 2210505401 | E452N3N10K11A1C  |
| 4358 | 2210505402 | E452N3N10K11A1D  |
| 4359 | 2210505403 | E452N3N10K11A1E  |
| 4360 | 2210505404 | E452N3N10K11A1G  |

| Pos. | Molex PN:  | Engineering No.: |
|------|------------|------------------|
| 4361 | 2210505405 | E452N3N10K11A1H  |
| 4362 | 2210505406 | E452N3N10K11A1K  |
| 4363 | 2210505407 | E452N3N10K11A1L  |
| 4364 | 2210505408 | E452N3N10K11A1M  |
| 4365 | 2210505409 | E452N3N10K11C31  |
| 4366 | 2210505410 | E452N3N10K11C32  |
| 4367 | 2210505411 | E452N3N10K11C33  |
| 4368 | 2210505412 | E452N3N10K11C34  |
| 4369 | 2210505413 | E452N3N10K11C35  |
| 4370 | 2210505414 | E452N3N10K11C3A  |
| 4371 | 2210505415 | E452N3N10K11C3B  |
| 4372 | 2210505416 | E452N3N10K11C3C  |
| 4373 | 2210505417 | E452N3N10K11C3D  |
| 4374 | 2210505418 | E452N3N10K11C3E  |
| 4375 | 2210505419 | E452N3N10K11C3G  |
| 4376 | 2210505420 | E452N3N10K11C3H  |
| 4377 | 2210505421 | E452N3N10K11C3K  |
| 4378 | 2210505422 | E452N3N10K11C3L  |
| 4379 | 2210505423 | E452N3N10K11C3M  |
| 4380 | 2210505424 | E452N3N10K11C41  |
| 4381 | 2210505425 | E452N3N10K11C43  |
| 4382 | 2210505426 | E452N3N10K11C44  |
| 4383 | 2210505427 | E452N3N10K11C45  |
| 4384 | 2210505428 | E452N3N10K11C4A  |
| 4385 | 2210505429 | E452N3N10K11C4B  |
| 4386 | 2210505430 | E452N3N10K11C4C  |
| 4387 | 2210505431 | E452N3N10K11C4D  |
| 4388 | 2210505432 | E452N3N10K11C4E  |
| 4389 | 2210505433 | E452N3N10K11C4G  |
| 4390 | 2210505434 | E452N3N10K11C4K  |
| 4391 | 2210505435 | E452N3N10K11C4M  |
| 4392 | 2210505440 | E452N3N10K11E05  |
| 4393 | 2210505455 | E452N3N10K11R05  |
| 4394 | 2210505466 | E452N3N10K11R21  |
| 4395 | 2210505467 | E452N3N10K11R22  |
| 4396 | 2210505468 | E452N3N10K11R23  |
| 4397 | 2210505469 | E452N3N10K11R24  |
| 4398 | 2210505470 | E452N3N10K11R25  |
| 4399 | 2210505471 | E452N3N10K11R2A  |
| 4400 | 2210505472 | E452N3N10K11R2B  |

| Pos. | Molex PN:  | Engineering No.: |
|------|------------|------------------|
| 4401 | 2210505473 | E452N3N10K11R2C  |
| 4402 | 2210505474 | E452N3N10K11R2D  |
| 4403 | 2210505475 | E452N3N10K11R2E  |
| 4404 | 2210505476 | E452N3N10K11R2G  |
| 4405 | 2210505477 | E452N3N10K11R2H  |
| 4406 | 2210505478 | E452N3N10K11R2K  |
| 4407 | 2210505479 | E452N3N10K11R2L  |
| 4408 | 2210505480 | E452N3N10K11R2M  |
| 4409 | 2210505481 | E452N3N10K11S01  |
| 4410 | 2210505482 | E452N3N10K11S03  |
| 4411 | 2210505483 | E452N3N10K11S04  |
| 4412 | 2210505484 | E452N3N10K11S05  |
| 4413 | 2210505485 | E452N3N10K11S0A  |
| 4414 | 2210505486 | E452N3N10K11S0B  |
| 4415 | 2210505487 | E452N3N10K11S0C  |
| 4416 | 2210505488 | E452N3N10K11S0D  |
| 4417 | 2210505489 | E452N3N10K11S0E  |
| 4418 | 2210505490 | E452N3N10K11S0G  |
| 4419 | 2210505491 | E452N3N10K11S0K  |
| 4420 | 2210505492 | E452N3N10K11S0L  |
| 4421 | 2210505493 | E452N3N10K11S0M  |
| 4422 | 2210505494 | E452N3N15011000  |
| 4423 | 2210505495 | E452N3N15011A13  |
| 4424 | 2210505496 | E452N3N15011A14  |
| 4425 | 2210505497 | E452N3N15011A1A  |
| 4426 | 2210505498 | E452N3N15011A1B  |
| 4427 | 2210505499 | E452N3N15011A1C  |
| 4428 | 2210505500 | E452N3N15011A1D  |
| 4429 | 2210505501 | E452N3N15011A1E  |
| 4430 | 2210505502 | E452N3N15011A1G  |
| 4431 | 2210505503 | E452N3N15011A1H  |
| 4432 | 2210505504 | E452N3N15011A1K  |
| 4433 | 2210505505 | E452N3N15011A1L  |
| 4434 | 2210505506 | E452N3N15011A1M  |
| 4435 | 2210505507 | E452N3N15011C31  |
| 4436 | 2210505508 | E452N3N15011C33  |
| 4437 | 2210505509 | E452N3N15011C34  |
| 4438 | 2210505510 | E452N3N15011C35  |
| 4439 | 2210505511 | E452N3N15011C3B  |
| 4440 | 2210505512 | E452N3N15011C3C  |

| Pos. | Molex PN:  | Engineering No.: |
|------|------------|------------------|
| 4441 | 2210505513 | E452N3N15011C3D  |
| 4442 | 2210505514 | E452N3N15011C3E  |
| 4443 | 2210505515 | E452N3N15011C3G  |
| 4444 | 2210505516 | E452N3N15011C3H  |
| 4445 | 2210505517 | E452N3N15011C3K  |
| 4446 | 2210505518 | E452N3N15011C3L  |
| 4447 | 2210505519 | E452N3N15011C3M  |
| 4448 | 2210505520 | E452N3N15011C41  |
| 4449 | 2210505521 | E452N3N15011C42  |
| 4450 | 2210505522 | E452N3N15011C43  |
| 4451 | 2210505523 | E452N3N15011C44  |
| 4452 | 2210505524 | E452N3N15011C45  |
| 4453 | 2210505525 | E452N3N15011C4A  |
| 4454 | 2210505526 | E452N3N15011C4B  |
| 4455 | 2210505527 | E452N3N15011C4C  |
| 4456 | 2210505528 | E452N3N15011C4D  |
| 4457 | 2210505529 | E452N3N15011C4E  |
| 4458 | 2210505530 | E452N3N15011C4G  |
| 4459 | 2210505531 | E452N3N15011C4H  |
| 4460 | 2210505532 | E452N3N15011C4K  |
| 4461 | 2210505533 | E452N3N15011C4L  |
| 4462 | 2210505534 | E452N3N15011C4M  |
| 4463 | 2210505539 | E452N3N15011E05  |
| 4464 | 2210505554 | E452N3N15011R05  |
| 4465 | 2210505565 | E452N3N15011R21  |
| 4466 | 2210505566 | E452N3N15011R22  |
| 4467 | 2210505567 | E452N3N15011R23  |
| 4468 | 2210505568 | E452N3N15011R24  |
| 4469 | 2210505569 | E452N3N15011R25  |
| 4470 | 2210505570 | E452N3N15011R2A  |
| 4471 | 2210505571 | E452N3N15011R2B  |
| 4472 | 2210505572 | E452N3N15011R2C  |
| 4473 | 2210505573 | E452N3N15011R2D  |
| 4474 | 2210505574 | E452N3N15011R2E  |
| 4475 | 2210505575 | E452N3N15011R2G  |
| 4476 | 2210505576 | E452N3N15011R2H  |
| 4477 | 2210505577 | E452N3N15011R2K  |
| 4478 | 2210505578 | E452N3N15011R2L  |
| 4479 | 2210505579 | E452N3N15011R2M  |
| 4480 | 2210505580 | E452N3N15011S01  |

|   |  |       |  |   |  |         |  |  |  |   |          |                          |
|---|--|-------|--|---|--|---------|--|--|--|---|----------|--------------------------|
| THIS DRAWING CONTAINS INFORMATION THAT IS PROPRIETARY TO MOLEX ELECTRONIC TECHNOLOGIES, LLC AND SHOULD NOT BE USED WITHOUT WRITTEN PERMISSION |  |       |  |   |  |         |  |  |  |   |          |                          |
| DIMENSION UNITS   |  | SCALE |  | CURRENT REV DESC: REVISION CREATED FOR REMOVING PRE-RELEASE STAMP                     |  |         |  |  |  | <br>E452XXXXXXXXXX<br>DIN FORM A EN 175301-803 |          |                          |
| mm  |  | NTS   |  |   |  |         |  |  |  |   |          |                          |
| GENERAL TOLERANCES (UNLESS SPECIFIED)   |  |       |  | MM  |  | INCH    |  | EC NO: 714567<br>DRWN: SUGEEB 2022/07/18<br>CHK'D: GGA 2022/07/19<br>APPR: GGA 2022/07/19<br>INITIAL REVISION:<br>DRWN: JMARSZALEK 2012/08/27<br>APPR: MDYSZEWSKA 2012/08/20 |  |   |          |                          |
| 4 PLACES  |  | ±     |  | ±   |  | ±       |  |  |  |   |          |                          |
| 3 PLACES  |  | ±     |  | ±   |  | ±       |  |  |  |   |          |                          |
| 2 PLACES  |  | ±     |  | ±   |  | ±       |  |  |  |   |          |                          |
| 1 PLACE   |  | ±     |  | ±   |  | ±       |  |  |  |   |          |                          |
| 0 PLACES  |  | ±     |  | ±   |  | ±       |  | DOCUMENT NUMBER<br><b>SD-121050-001</b>  |  | DOC TYPE  | DOC PART | REVISION                 |
| ANGULAR TOL   |  | ± °   |  |   |  |         |  | MATERIAL NUMBER<br>SEE TABLE   |  | CUSTOMER<br>GENERAL MARKET  |          | SHEET NUMBER<br>31 OF 41 |
| DRAFT WHERE APPLICABLE MUST REMAIN WITHIN DIMENSIONS  |  |       |  | FIRST ANGLE PROJECTION  |  | DRAWING |  | SERIES   |  |   |          |                          |
|   |  |       |  |  |  | A3-SIZE |  | 121050   |  |   |          |                          |

TABLE 3 - PART LIST

| Pos. | Molex PN:  | Engineering No.: |
|------|------------|------------------|
| 4481 | 2210505581 | E452N3N15011S02  |
| 4482 | 2210505582 | E452N3N15011S03  |
| 4483 | 2210505583 | E452N3N15011S04  |
| 4484 | 2210505584 | E452N3N15011S05  |
| 4485 | 2210505585 | E452N3N15011S0A  |
| 4486 | 2210505586 | E452N3N15011S0B  |
| 4487 | 2210505587 | E452N3N15011S0C  |
| 4488 | 2210505588 | E452N3N15011S0D  |
| 4489 | 2210505589 | E452N3N15011S0E  |
| 4490 | 2210505590 | E452N3N15011S0G  |
| 4491 | 2210505591 | E452N3N15011S0H  |
| 4492 | 2210505592 | E452N3N15011S0K  |
| 4493 | 2210505593 | E452N3N15011S0L  |
| 4494 | 2210505594 | E452N3N15011S0M  |
| 4495 | 2210505595 | E452N3N20011000  |
| 4496 | 2210505596 | E452N3N20011A13  |
| 4497 | 2210505597 | E452N3N20011A15  |
| 4498 | 2210505598 | E452N3N20011A1A  |
| 4499 | 2210505599 | E452N3N20011A1B  |
| 4500 | 2210505600 | E452N3N20011A1C  |
| 4501 | 2210505601 | E452N3N20011A1D  |
| 4502 | 2210505602 | E452N3N20011A1E  |
| 4503 | 2210505603 | E452N3N20011A1G  |
| 4504 | 2210505604 | E452N3N20011A1K  |
| 4505 | 2210505605 | E452N3N20011A1L  |
| 4506 | 2210505606 | E452N3N20011A1M  |
| 4507 | 2210505607 | E452N3N20011C31  |
| 4508 | 2210505608 | E452N3N20011C32  |
| 4509 | 2210505609 | E452N3N20011C33  |
| 4510 | 2210505610 | E452N3N20011C34  |
| 4511 | 2210505611 | E452N3N20011C35  |
| 4512 | 2210505612 | E452N3N20011C3A  |
| 4513 | 2210505613 | E452N3N20011C3B  |
| 4514 | 2210505614 | E452N3N20011C3C  |
| 4515 | 2210505615 | E452N3N20011C3D  |
| 4516 | 2210505616 | E452N3N20011C3E  |
| 4517 | 2210505617 | E452N3N20011C3G  |
| 4518 | 2210505618 | E452N3N20011C3H  |
| 4519 | 2210505619 | E452N3N20011C3K  |
| 4520 | 2210505620 | E452N3N20011C3L  |

| Pos. | Molex PN:  | Engineering No.: |
|------|------------|------------------|
| 4521 | 2210505621 | E452N3N20011C3M  |
| 4522 | 2210505622 | E452N3N20011C43  |
| 4523 | 2210505623 | E452N3N20011C44  |
| 4524 | 2210505624 | E452N3N20011C45  |
| 4525 | 2210505625 | E452N3N20011C4A  |
| 4526 | 2210505626 | E452N3N20011C4B  |
| 4527 | 2210505627 | E452N3N20011C4C  |
| 4528 | 2210505628 | E452N3N20011C4D  |
| 4529 | 2210505629 | E452N3N20011C4E  |
| 4530 | 2210505630 | E452N3N20011C4G  |
| 4531 | 2210505631 | E452N3N20011C4K  |
| 4532 | 2210505632 | E452N3N20011C4M  |
| 4533 | 2210505637 | E452N3N20011E05  |
| 4534 | 2210505662 | E452N3N20011R21  |
| 4535 | 2210505663 | E452N3N20011R22  |
| 4536 | 2210505664 | E452N3N20011R23  |
| 4537 | 2210505665 | E452N3N20011R24  |
| 4538 | 2210505666 | E452N3N20011R25  |
| 4539 | 2210505667 | E452N3N20011R2A  |
| 4540 | 2210505668 | E452N3N20011R2B  |
| 4541 | 2210505669 | E452N3N20011R2C  |
| 4542 | 2210505670 | E452N3N20011R2D  |
| 4543 | 2210505671 | E452N3N20011R2E  |
| 4544 | 2210505672 | E452N3N20011R2G  |
| 4545 | 2210505673 | E452N3N20011R2K  |
| 4546 | 2210505674 | E452N3N20011R2L  |
| 4547 | 2210505675 | E452N3N20011S01  |
| 4548 | 2210505676 | E452N3N20011S02  |
| 4549 | 2210505677 | E452N3N20011S03  |
| 4550 | 2210505678 | E452N3N20011S04  |
| 4551 | 2210505679 | E452N3N20011S05  |
| 4552 | 2210505680 | E452N3N20011S0A  |
| 4553 | 2210505681 | E452N3N20011S0B  |
| 4554 | 2210505682 | E452N3N20011S0C  |
| 4555 | 2210505683 | E452N3N20011S0D  |
| 4556 | 2210505684 | E452N3N20011S0E  |
| 4557 | 2210505685 | E452N3N20011S0G  |
| 4558 | 2210505686 | E452N3N20011S0H  |
| 4559 | 2210505687 | E452N3N20011S0K  |
| 4560 | 2210505688 | E452N3N20011S0L  |

| Pos. | Molex PN:  | Engineering No.: |
|------|------------|------------------|
| 4561 | 2210505689 | E452N3N20011S0M  |
| 4562 | 2210505690 | E452N3N30011000  |
| 4563 | 2210505691 | E452N3N30011A12  |
| 4564 | 2210505692 | E452N3N30011A13  |
| 4565 | 2210505693 | E452N3N30011A14  |
| 4566 | 2210505694 | E452N3N30011A15  |
| 4567 | 2210505695 | E452N3N30011A1A  |
| 4568 | 2210505696 | E452N3N30011A1B  |
| 4569 | 2210505697 | E452N3N30011A1C  |
| 4570 | 2210505698 | E452N3N30011A1D  |
| 4571 | 2210505699 | E452N3N30011A1E  |
| 4572 | 2210505700 | E452N3N30011A1G  |
| 4573 | 2210505701 | E452N3N30011A1K  |
| 4574 | 2210505702 | E452N3N30011A1L  |
| 4575 | 2210505703 | E452N3N30011A1M  |
| 4576 | 2210505704 | E452N3N30011C31  |
| 4577 | 2210505705 | E452N3N30011C33  |
| 4578 | 2210505706 | E452N3N30011C34  |
| 4579 | 2210505707 | E452N3N30011C35  |
| 4580 | 2210505708 | E452N3N30011C3A  |
| 4581 | 2210505709 | E452N3N30011C3B  |
| 4582 | 2210505710 | E452N3N30011C3C  |
| 4583 | 2210505711 | E452N3N30011C3D  |
| 4584 | 2210505712 | E452N3N30011C3E  |
| 4585 | 2210505713 | E452N3N30011C3G  |
| 4586 | 2210505714 | E452N3N30011C3H  |
| 4587 | 2210505715 | E452N3N30011C3K  |
| 4588 | 2210505716 | E452N3N30011C3L  |
| 4589 | 2210505717 | E452N3N30011C3M  |
| 4590 | 2210505718 | E452N3N30011C43  |
| 4591 | 2210505719 | E452N3N30011C4A  |
| 4592 | 2210505720 | E452N3N30011C4B  |
| 4593 | 2210505721 | E452N3N30011C4C  |
| 4594 | 2210505722 | E452N3N30011C4D  |
| 4595 | 2210505723 | E452N3N30011C4E  |
| 4596 | 2210505724 | E452N3N30011C4G  |
| 4597 | 2210505725 | E452N3N30011C4K  |
| 4598 | 2210505730 | E452N3N30011E05  |
| 4599 | 2210505745 | E452N3N30011R05  |
| 4600 | 2210505756 | E452N3N30011R21  |

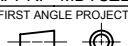
| Pos. | Molex PN:  | Engineering No.: |
|------|------------|------------------|
| 4601 | 2210505757 | E452N3N30011R23  |
| 4602 | 2210505758 | E452N3N30011R24  |
| 4603 | 2210505759 | E452N3N30011R25  |
| 4604 | 2210505760 | E452N3N30011R2A  |
| 4605 | 2210505761 | E452N3N30011R2B  |
| 4606 | 2210505762 | E452N3N30011R2C  |
| 4607 | 2210505763 | E452N3N30011R2D  |
| 4608 | 2210505764 | E452N3N30011R2E  |
| 4609 | 2210505765 | E452N3N30011R2G  |
| 4610 | 2210505766 | E452N3N30011R2K  |
| 4611 | 2210505767 | E452N3N30011R2L  |
| 4612 | 2210505768 | E452N3N30011R2M  |
| 4613 | 2210505769 | E452N3N30011S01  |
| 4614 | 2210505770 | E452N3N30011S02  |
| 4615 | 2210505771 | E452N3N30011S03  |
| 4616 | 2210505772 | E452N3N30011S04  |
| 4617 | 2210505773 | E452N3N30011S05  |
| 4618 | 2210505774 | E452N3N30011S0A  |
| 4619 | 2210505775 | E452N3N30011S0B  |
| 4620 | 2210505776 | E452N3N30011S0C  |
| 4621 | 2210505777 | E452N3N30011S0E  |
| 4622 | 2210505778 | E452N3N30011S0G  |
| 4623 | 2210505779 | E452N3N30011S0H  |
| 4624 | 2210505780 | E452N3N30011S0K  |
| 4625 | 2210505781 | E452N3N30011S0L  |
| 4626 | 2210505782 | E452N3N30011S0M  |
| 4627 | 2210505783 | E452N3N50011000  |
| 4628 | 2210505784 | E452N3N50011A11  |
| 4629 | 2210505785 | E452N3N50011A12  |
| 4630 | 2210505786 | E452N3N50011A13  |
| 4631 | 2210505787 | E452N3N50011A14  |
| 4632 | 2210505788 | E452N3N50011A15  |
| 4633 | 2210505789 | E452N3N50011A1A  |
| 4634 | 2210505790 | E452N3N50011A1C  |
| 4635 | 2210505791 | E452N3N50011A1D  |
| 4636 | 2210505792 | E452N3N50011A1E  |
| 4637 | 2210505793 | E452N3N50011A1G  |
| 4638 | 2210505794 | E452N3N50011A1H  |
| 4639 | 2210505795 | E452N3N50011A1K  |
| 4640 | 2210505796 | E452N3N50011A1L  |

|   |  |       |      |   |   |              |   |            |   |   |  |
|---|--|-------|------|---|---|--------------|---|------------|---|---|--|
| THIS DRAWING CONTAINS INFORMATION THAT IS PROPRIETARY TO MOLEX ELECTRONIC TECHNOLOGIES, LLC AND SHOULD NOT BE USED WITHOUT WRITTEN PERMISSION |  |       |      |   |   |              |   |            |   |   |  |
| DIMENSION UNITS   |  | SCALE |      | CURRENT REV DESC: REVISION CREATED FOR REMOVING PRE-RELEASE STAMP                     |   |              |   |            |   | <br>E452XXXXXXXXXX<br>DIN FORM A EN 175301-803 |  |
| mm  |  | NTS   |      |   |   |              |   |            |   |   |  |
| GENERAL TOLERANCES (UNLESS SPECIFIED)   |  |       |      |   |   |              |   |            |   |   |  |
|   |  | MM    | INCH |   |   |              |   |            |   |   |  |
| 4 PLACES  |  | ±     | ±    |   |   |              |   |            |   |   |  |
| 3 PLACES  |  | ±     | ±    |   |   |              |   |            |   |   |  |
| 2 PLACES  |  | ±     | ±    |   |   |              |   |            |   |   |  |
| 1 PLACE   |  | ±     | ±    |   |   |              |   |            |   |   |  |
| 0 PLACES  |  | ±     | ±    |   |   |              |   |            |   |   |  |
| ANGULAR TOL   |  | ±     | °    |   |   |              |   |            |   |   |  |
| DRAFT WHERE APPLICABLE MUST REMAIN WITHIN DIMENSIONS  |  |       |      | FIRST ANGLE PROJECTION  |   | DRAWING      |   | SERIES     |   | MATERIAL NUMBER   |  |
|   |  |       |      |  |   | A3-SIZE      |   | 121050     |   | SEE TABLE   |  |
| DOCUMENT STATUS   |  |       |      | P1  |   | RELEASE DATE |   | 2022/07/19 |   | 09:04:35  |  |
|   |  | 9     | 8    | 7   | 6 | 5            | 4 | 3          | 2 | 1   |  |

TABLE 3 - PART LIST

| Pos. | Molex PN:  | Engineering No.: |
|------|------------|------------------|
| 4641 | 2210505797 | E452N3N50011A1M  |
| 4642 | 2210505798 | E452N3N50011C31  |
| 4643 | 2210505799 | E452N3N50011C32  |
| 4644 | 2210505800 | E452N3N50011C33  |
| 4645 | 2210505801 | E452N3N50011C34  |
| 4646 | 2210505802 | E452N3N50011C35  |
| 4647 | 2210505803 | E452N3N50011C3A  |
| 4648 | 2210505804 | E452N3N50011C3B  |
| 4649 | 2210505805 | E452N3N50011C3C  |
| 4650 | 2210505806 | E452N3N50011C3D  |
| 4651 | 2210505807 | E452N3N50011C3E  |
| 4652 | 2210505808 | E452N3N50011C3G  |
| 4653 | 2210505809 | E452N3N50011C3K  |
| 4654 | 2210505810 | E452N3N50011C3L  |
| 4655 | 2210505811 | E452N3N50011C3M  |
| 4656 | 2210505812 | E452N3N50011C41  |
| 4657 | 2210505813 | E452N3N50011C43  |
| 4658 | 2210505814 | E452N3N50011C45  |
| 4659 | 2210505815 | E452N3N50011C4A  |
| 4660 | 2210505816 | E452N3N50011C4C  |
| 4661 | 2210505817 | E452N3N50011C4G  |
| 4662 | 2210505818 | E452N3N50011C4K  |
| 4663 | 2210505823 | E452N3N50011E05  |
| 4664 | 2210505838 | E452N3N50011R05  |
| 4665 | 2210505849 | E452N3N50011R21  |
| 4666 | 2210505850 | E452N3N50011R22  |
| 4667 | 2210505851 | E452N3N50011R23  |
| 4668 | 2210505852 | E452N3N50011R24  |
| 4669 | 2210505853 | E452N3N50011R25  |
| 4670 | 2210505854 | E452N3N50011R2A  |
| 4671 | 2210505855 | E452N3N50011R2B  |
| 4672 | 2210505856 | E452N3N50011R2C  |
| 4673 | 2210505857 | E452N3N50011R2D  |
| 4674 | 2210505858 | E452N3N50011R2E  |
| 4675 | 2210505859 | E452N3N50011R2G  |
| 4676 | 2210505860 | E452N3N50011R2H  |
| 4677 | 2210505861 | E452N3N50011R2K  |
| 4678 | 2210505862 | E452N3N50011R2L  |
| 4679 | 2210505863 | E452N3N50011R2M  |
| 4680 | 2210505864 | E452N3N50011S01  |

| Pos. | Molex PN:  | Engineering No.: |
|------|------------|------------------|
| 4681 | 2210505865 | E452N3N50011S03  |
| 4682 | 2210505866 | E452N3N50011S04  |
| 4683 | 2210505867 | E452N3N50011S05  |
| 4684 | 2210505868 | E452N3N50011S0A  |
| 4685 | 2210505869 | E452N3N50011S0B  |
| 4686 | 2210505870 | E452N3N50011S0C  |
| 4687 | 2210505871 | E452N3N50011S0E  |
| 4688 | 2210505872 | E452N3N50011S0G  |
| 4689 | 2210505873 | E452N3N50011S0K  |
| 4690 | 2210505874 | E452N3N50011S0L  |
| 4691 | 2210505875 | E452N3N50011S0M  |
| 4692 | 2210505876 | E452N4N10011000  |
| 4693 | 2210505877 | E452N4N10011A11  |
| 4694 | 2210505878 | E452N4N10011A12  |
| 4695 | 2210505879 | E452N4N10011A13  |
| 4696 | 2210505880 | E452N4N10011A14  |
| 4697 | 2210505881 | E452N4N10011A15  |
| 4698 | 2210505882 | E452N4N10011A1A  |
| 4699 | 2210505883 | E452N4N10011A1B  |
| 4700 | 2210505884 | E452N4N10011A1C  |
| 4701 | 2210505885 | E452N4N10011A1D  |
| 4702 | 2210505886 | E452N4N10011A1E  |
| 4703 | 2210505887 | E452N4N10011A1G  |
| 4704 | 2210505888 | E452N4N10011A1H  |
| 4705 | 2210505889 | E452N4N10011A1K  |
| 4706 | 2210505890 | E452N4N10011A1L  |
| 4707 | 2210505891 | E452N4N10011A1M  |
| 4708 | 2210505892 | E452N4N10011C31  |
| 4709 | 2210505893 | E452N4N10011C32  |
| 4710 | 2210505894 | E452N4N10011C33  |
| 4711 | 2210505895 | E452N4N10011C34  |
| 4712 | 2210505896 | E452N4N10011C35  |
| 4713 | 2210505897 | E452N4N10011C3A  |
| 4714 | 2210505898 | E452N4N10011C3B  |
| 4715 | 2210505899 | E452N4N10011C3C  |
| 4716 | 2210505900 | E452N4N10011C3D  |
| 4717 | 2210505901 | E452N4N10011C3E  |
| 4718 | 2210505902 | E452N4N10011C3G  |
| 4719 | 2210505903 | E452N4N10011C3H  |
| 4720 | 2210505904 | E452N4N10011C3K  |

| Pos. | Molex PN:  | Engineering No.: |
|------|------------|------------------|
| 4721 | 2210505905 | E452N4N10011C3L  |
| 4722 | 2210505906 | E452N4N10011C3M  |
| 4723 | 2210505907 | E452N4N10011C41  |
| 4724 | 2210505908 | E452N4N10011C42  |
| 4725 | 2210505909 | E452N4N10011C43  |
| 4726 | 2210505910 | E452N4N10011C44  |
| 4727 | 2210505911 | E452N4N10011C45  |
| 4728 | 2210505912 | E452N4N10011C4A  |
| 4729 | 2210505913 | E452N4N10011C4B  |
| 4730 | 2210505914 | E452N4N10011C4C  |
| 4731 | 2210505915 | E452N4N10011C4D  |
| 4732 | 2210505916 | E452N4N10011C4E  |
| 4733 | 2210505917 | E452N4N10011C4G  |
| 4734 | 2210505918 | E452N4N10011C4H  |
| 4735 | 2210505919 | E452N4N10011C4K  |
| 4736 | 2210505920 | E452N4N10011C4L  |
| 4737 | 2210505921 | E452N4N10011C4M  |
| 4738 | 2210505926 | E452N4N10011E05  |
| 4739 | 2210505941 | E452N4N10011R05  |
| 4740 | 2210505952 | E452N4N10011R21  |
| 4741 | 2210505953 | E452N4N10011R22  |
| 4742 | 2210505954 | E452N4N10011R23  |
| 4743 | 2210505955 | E452N4N10011R24  |
| 4744 | 2210505956 | E452N4N10011R25  |
| 4745 | 2210505957 | E452N4N10011R2A  |
| 4746 | 2210505958 | E452N4N10011R2B  |
| 4747 | 2210505959 | E452N4N10011R2C  |
| 4748 | 2210505960 | E452N4N10011R2D  |
| 4749 | 2210505961 | E452N4N10011R2E  |
| 4750 | 2210505962 | E452N4N10011R2G  |
| 4751 | 2210505963 | E452N4N10011R2H  |
| 4752 | 2210505964 | E452N4N10011R2K  |
| 4753 | 2210505965 | E452N4N10011R2L  |
| 4754 | 2210505966 | E452N4N10011R2M  |
| 4755 | 2210505967 | E452N4N10011S01  |
| 4756 | 2210505968 | E452N4N10011S02  |
| 4757 | 2210505969 | E452N4N10011S03  |
| 4758 | 2210505970 | E452N4N10011S04  |
| 4759 | 2210505971 | E452N4N10011S05  |
| 4760 | 2210505972 | E452N4N10011S0A  |

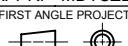
| Pos. | Molex PN:  | Engineering No.: |
|------|------------|------------------|
| 4761 | 2210505973 | E452N4N10011S0B  |
| 4762 | 2210505974 | E452N4N10011S0C  |
| 4763 | 2210505975 | E452N4N10011S0D  |
| 4764 | 2210505976 | E452N4N10011S0E  |
| 4765 | 2210505977 | E452N4N10011S0G  |
| 4766 | 2210505978 | E452N4N10011S0H  |
| 4767 | 2210505979 | E452N4N10011S0K  |
| 4768 | 2210505980 | E452N4N10011S0L  |
| 4769 | 2210505981 | E452N4N10011S0M  |
| 4770 | 2210505982 | E452N4N10K11000  |
| 4771 | 2210505983 | E452N4N10K11A11  |
| 4772 | 2210505984 | E452N4N10K11A12  |
| 4773 | 2210505985 | E452N4N10K11A13  |
| 4774 | 2210505986 | E452N4N10K11A14  |
| 4775 | 2210505987 | E452N4N10K11A15  |
| 4776 | 2210505988 | E452N4N10K11A1A  |
| 4777 | 2210505989 | E452N4N10K11A1B  |
| 4778 | 2210505990 | E452N4N10K11A1C  |
| 4779 | 2210505991 | E452N4N10K11A1D  |
| 4780 | 2210505992 | E452N4N10K11A1E  |
| 4781 | 2210505993 | E452N4N10K11A1G  |
| 4782 | 2210505994 | E452N4N10K11A1H  |
| 4783 | 2210505995 | E452N4N10K11A1K  |
| 4784 | 2210505996 | E452N4N10K11A1L  |
| 4785 | 2210505997 | E452N4N10K11A1M  |
| 4786 | 2210505998 | E452N4N10K11C31  |
| 4787 | 2210505999 | E452N4N10K11C32  |
| 4788 | 2210506000 | E452N4N10K11C33  |
| 4789 | 2210506001 | E452N4N10K11C34  |
| 4790 | 2210506002 | E452N4N10K11C35  |
| 4791 | 2210506003 | E452N4N10K11C3A  |
| 4792 | 2210506004 | E452N4N10K11C3B  |
| 4793 | 2210506005 | E452N4N10K11C3C  |
| 4794 | 2210506006 | E452N4N10K11C3D  |
| 4795 | 2210506007 | E452N4N10K11C3E  |
| 4796 | 2210506008 | E452N4N10K11C3G  |
| 4797 | 2210506009 | E452N4N10K11C3H  |
| 4798 | 2210506010 | E452N4N10K11C3K  |
| 4799 | 2210506011 | E452N4N10K11C3L  |
| 4800 | 2210506012 | E452N4N10K11C3M  |

|   |  |       |  |   |  |                |  |   |  |
|---|--|-------|--|---|--|----------------|--|---|--|
| THIS DRAWING CONTAINS INFORMATION THAT IS PROPRIETARY TO MOLEX ELECTRONIC TECHNOLOGIES, LLC AND SHOULD NOT BE USED WITHOUT WRITTEN PERMISSION |  |       |  |   |  |                |  |   |  |
| DIMENSION UNITS   |  | SCALE |  | CURRENT REV DESC: REVISION CREATED FOR REMOVING PRE-RELEASE STAMP                     |  |                |  | <br>E452XXXXXXXXXX<br>DIN FORM A EN 175301-803 |  |
| mm  |  | NTS   |  |   |  |                |  |   |  |
| GENERAL TOLERANCES (UNLESS SPECIFIED)   |  |       |  | EC NO: 714567   |  | 2022/07/18     |  | PRODUCT CUSTOMER DRAWING<br>DOCUMENT NUMBER: SD-121050-001<br>DOC TYPE: PSD<br>DOC PART: 001<br>REVISION: E1                        |  |
|   |  |       |  | DRWN: SUGEEB  |  | 2022/07/19     |  |   |  |
|   |  |       |  | CHK'D: GGA  |  | 2022/07/19     |  |   |  |
|   |  |       |  | APPR: GGA   |  |                |  |   |  |
|   |  |       |  | INITIAL REVISION:   |  |                |  |   |  |
|   |  |       |  | DRWN: JMARSZALEK  |  | 2012/08/27     |  |   |  |
|   |  |       |  | APPR: MDYSZEWSKA  |  | 2012/08/20     |  |   |  |
| DRAFT WHERE APPLICABLE MUST REMAIN WITHIN DIMENSIONS  |  |       |  | FIRST ANGLE PROJECTION  |  | DRAWING        |  | SERIES  |  |
|   |  |       |  |  |  | A3-SIZE        |  | 121050  |  |
|   |  |       |  | MATERIAL NUMBER   |  | CUSTOMER       |  | SHEET NUMBER  |  |
|   |  |       |  | SEE TABLE   |  | GENERAL MARKET |  | 33 OF 41  |  |

TABLE 3 - PART LIST

| Pos. | Molex PN:  | Engineering No.: |
|------|------------|------------------|
| 4801 | 2210506013 | E452N4N10K11C41  |
| 4802 | 2210506014 | E452N4N10K11C42  |
| 4803 | 2210506015 | E452N4N10K11C43  |
| 4804 | 2210506016 | E452N4N10K11C44  |
| 4805 | 2210506017 | E452N4N10K11C45  |
| 4806 | 2210506018 | E452N4N10K11C4A  |
| 4807 | 2210506019 | E452N4N10K11C4B  |
| 4808 | 2210506020 | E452N4N10K11C4C  |
| 4809 | 2210506021 | E452N4N10K11C4D  |
| 4810 | 2210506022 | E452N4N10K11C4E  |
| 4811 | 2210506023 | E452N4N10K11C4G  |
| 4812 | 2210506024 | E452N4N10K11C4H  |
| 4813 | 2210506025 | E452N4N10K11C4K  |
| 4814 | 2210506026 | E452N4N10K11C4L  |
| 4815 | 2210506027 | E452N4N10K11C4M  |
| 4816 | 2210506032 | E452N4N10K11E05  |
| 4817 | 2210506047 | E452N4N10K11R05  |
| 4818 | 2210506058 | E452N4N10K11R21  |
| 4819 | 2210506059 | E452N4N10K11R22  |
| 4820 | 2210506060 | E452N4N10K11R23  |
| 4821 | 2210506061 | E452N4N10K11R24  |
| 4822 | 2210506062 | E452N4N10K11R25  |
| 4823 | 2210506063 | E452N4N10K11R2A  |
| 4824 | 2210506064 | E452N4N10K11R2B  |
| 4825 | 2210506065 | E452N4N10K11R2C  |
| 4826 | 2210506066 | E452N4N10K11R2D  |
| 4827 | 2210506067 | E452N4N10K11R2E  |
| 4828 | 2210506068 | E452N4N10K11R2G  |
| 4829 | 2210506069 | E452N4N10K11R2H  |
| 4830 | 2210506070 | E452N4N10K11R2K  |
| 4831 | 2210506071 | E452N4N10K11R2L  |
| 4832 | 2210506072 | E452N4N10K11R2M  |
| 4833 | 2210506073 | E452N4N10K11S01  |
| 4834 | 2210506074 | E452N4N10K11S02  |
| 4835 | 2210506075 | E452N4N10K11S03  |
| 4836 | 2210506076 | E452N4N10K11S04  |
| 4837 | 2210506077 | E452N4N10K11S05  |
| 4838 | 2210506078 | E452N4N10K11S0A  |
| 4839 | 2210506079 | E452N4N10K11S0B  |
| 4840 | 2210506080 | E452N4N10K11S0C  |

| Pos. | Molex PN:  | Engineering No.: |
|------|------------|------------------|
| 4841 | 2210506081 | E452N4N10K11S0D  |
| 4842 | 2210506082 | E452N4N10K11S0E  |
| 4843 | 2210506083 | E452N4N10K11S0G  |
| 4844 | 2210506084 | E452N4N10K11S0H  |
| 4845 | 2210506085 | E452N4N10K11S0K  |
| 4846 | 2210506086 | E452N4N10K11S0L  |
| 4847 | 2210506087 | E452N4N10K11S0M  |
| 4848 | 2210506088 | E452N4N15011000  |
| 4849 | 2210506089 | E452N4N15011A11  |
| 4850 | 2210506090 | E452N4N15011A12  |
| 4851 | 2210506091 | E452N4N15011A13  |
| 4852 | 2210506092 | E452N4N15011A14  |
| 4853 | 2210506093 | E452N4N15011A15  |
| 4854 | 2210506094 | E452N4N15011A1A  |
| 4855 | 2210506095 | E452N4N15011A1B  |
| 4856 | 2210506096 | E452N4N15011A1C  |
| 4857 | 2210506097 | E452N4N15011A1D  |
| 4858 | 2210506098 | E452N4N15011A1E  |
| 4859 | 2210506099 | E452N4N15011A1G  |
| 4860 | 2210506100 | E452N4N15011A1H  |
| 4861 | 2210506101 | E452N4N15011A1K  |
| 4862 | 2210506102 | E452N4N15011A1L  |
| 4863 | 2210506103 | E452N4N15011A1M  |
| 4864 | 2210506104 | E452N4N15011C31  |
| 4865 | 2210506105 | E452N4N15011C32  |
| 4866 | 2210506106 | E452N4N15011C33  |
| 4867 | 2210506107 | E452N4N15011C34  |
| 4868 | 2210506108 | E452N4N15011C35  |
| 4869 | 2210506109 | E452N4N15011C3A  |
| 4870 | 2210506110 | E452N4N15011C3B  |
| 4871 | 2210506111 | E452N4N15011C3C  |
| 4872 | 2210506112 | E452N4N15011C3D  |
| 4873 | 2210506113 | E452N4N15011C3E  |
| 4874 | 2210506114 | E452N4N15011C3G  |
| 4875 | 2210506115 | E452N4N15011C3H  |
| 4876 | 2210506116 | E452N4N15011C3K  |
| 4877 | 2210506117 | E452N4N15011C3L  |
| 4878 | 2210506118 | E452N4N15011C3M  |
| 4879 | 2210506119 | E452N4N15011C41  |
| 4880 | 2210506120 | E452N4N15011C42  |

| Pos. | Molex PN:  | Engineering No.: |
|------|------------|------------------|
| 4881 | 2210506121 | E452N4N15011C43  |
| 4882 | 2210506122 | E452N4N15011C44  |
| 4883 | 2210506123 | E452N4N15011C45  |
| 4884 | 2210506124 | E452N4N15011C4A  |
| 4885 | 2210506125 | E452N4N15011C4B  |
| 4886 | 2210506126 | E452N4N15011C4C  |
| 4887 | 2210506127 | E452N4N15011C4D  |
| 4888 | 2210506128 | E452N4N15011C4E  |
| 4889 | 2210506129 | E452N4N15011C4G  |
| 4890 | 2210506130 | E452N4N15011C4H  |
| 4891 | 2210506131 | E452N4N15011C4K  |
| 4892 | 2210506132 | E452N4N15011C4L  |
| 4893 | 2210506133 | E452N4N15011C4M  |
| 4894 | 2210506138 | E452N4N15011E05  |
| 4895 | 2210506153 | E452N4N15011R05  |
| 4896 | 2210506164 | E452N4N15011R21  |
| 4897 | 2210506165 | E452N4N15011R22  |
| 4898 | 2210506166 | E452N4N15011R23  |
| 4899 | 2210506167 | E452N4N15011R24  |
| 4900 | 2210506168 | E452N4N15011R25  |
| 4901 | 2210506169 | E452N4N15011R2A  |
| 4902 | 2210506170 | E452N4N15011R2B  |
| 4903 | 2210506171 | E452N4N15011R2C  |
| 4904 | 2210506172 | E452N4N15011R2D  |
| 4905 | 2210506173 | E452N4N15011R2E  |
| 4906 | 2210506174 | E452N4N15011R2G  |
| 4907 | 2210506175 | E452N4N15011R2H  |
| 4908 | 2210506176 | E452N4N15011R2K  |
| 4909 | 2210506177 | E452N4N15011R2L  |
| 4910 | 2210506178 | E452N4N15011R2M  |
| 4911 | 2210506179 | E452N4N15011S01  |
| 4912 | 2210506180 | E452N4N15011S02  |
| 4913 | 2210506181 | E452N4N15011S03  |
| 4914 | 2210506182 | E452N4N15011S04  |
| 4915 | 2210506183 | E452N4N15011S05  |
| 4916 | 2210506184 | E452N4N15011S0A  |
| 4917 | 2210506185 | E452N4N15011S0B  |
| 4918 | 2210506186 | E452N4N15011S0C  |
| 4919 | 2210506187 | E452N4N15011S0D  |
| 4920 | 2210506188 | E452N4N15011S0E  |

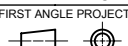
| Pos. | Molex PN:  | Engineering No.: |
|------|------------|------------------|
| 4921 | 2210506189 | E452N4N15011S0G  |
| 4922 | 2210506190 | E452N4N15011S0H  |
| 4923 | 2210506191 | E452N4N15011S0K  |
| 4924 | 2210506192 | E452N4N15011S0L  |
| 4925 | 2210506193 | E452N4N15011S0M  |
| 4926 | 2210506194 | E452N4N20011000  |
| 4927 | 2210506195 | E452N4N20011A11  |
| 4928 | 2210506196 | E452N4N20011A12  |
| 4929 | 2210506197 | E452N4N20011A13  |
| 4930 | 2210506198 | E452N4N20011A14  |
| 4931 | 2210506199 | E452N4N20011A15  |
| 4932 | 2210506200 | E452N4N20011A1A  |
| 4933 | 2210506201 | E452N4N20011A1B  |
| 4934 | 2210506202 | E452N4N20011A1C  |
| 4935 | 2210506203 | E452N4N20011A1D  |
| 4936 | 2210506204 | E452N4N20011A1E  |
| 4937 | 2210506205 | E452N4N20011A1G  |
| 4938 | 2210506206 | E452N4N20011A1H  |
| 4939 | 2210506207 | E452N4N20011A1K  |
| 4940 | 2210506208 | E452N4N20011A1L  |
| 4941 | 2210506209 | E452N4N20011A1M  |
| 4942 | 2210506210 | E452N4N20011C31  |
| 4943 | 2210506211 | E452N4N20011C32  |
| 4944 | 2210506212 | E452N4N20011C33  |
| 4945 | 2210506213 | E452N4N20011C34  |
| 4946 | 2210506214 | E452N4N20011C35  |
| 4947 | 2210506215 | E452N4N20011C3A  |
| 4948 | 2210506216 | E452N4N20011C3B  |
| 4949 | 2210506217 | E452N4N20011C3C  |
| 4950 | 2210506218 | E452N4N20011C3D  |
| 4951 | 2210506219 | E452N4N20011C3E  |
| 4952 | 2210506220 | E452N4N20011C3G  |
| 4953 | 2210506221 | E452N4N20011C3H  |
| 4954 | 2210506222 | E452N4N20011C3K  |
| 4955 | 2210506223 | E452N4N20011C3L  |
| 4956 | 2210506224 | E452N4N20011C3M  |
| 4957 | 2210506225 | E452N4N20011C41  |
| 4958 | 2210506226 | E452N4N20011C42  |
| 4959 | 2210506227 | E452N4N20011C43  |
| 4960 | 2210506228 | E452N4N20011C44  |

|   |  |       |  |   |  |            |  |   |  |
|---|--|-------|--|---|--|------------|--|---|--|
| THIS DRAWING CONTAINS INFORMATION THAT IS PROPRIETARY TO MOLEX ELECTRONIC TECHNOLOGIES, LLC AND SHOULD NOT BE USED WITHOUT WRITTEN PERMISSION |  |       |  |   |  |            |  |   |  |
| DIMENSION UNITS   |  | SCALE |  | CURRENT REV DESC: REVISION CREATED FOR REMOVING PRE-RELEASE STAMP                     |  |            |  | <br>E452XXXXXXXXXX<br>DIN FORM A EN 175301-803 |  |
| mm  |  | NTS   |  |   |  |            |  |   |  |
| GENERAL TOLERANCES (UNLESS SPECIFIED)   |  |       |  |   |  |            |  |   |  |
|   |  | MM    |  | INCH  |  |            |  |   |  |
| 4 PLACES  |  | ±     |  | ±   |  |            |  |   |  |
| 3 PLACES  |  | ±     |  | ±   |  |            |  |   |  |
| 2 PLACES  |  | ±     |  | ±   |  |            |  |   |  |
| 1 PLACE   |  | ±     |  | ±   |  |            |  |   |  |
| 0 PLACES  |  | ±     |  | ±   |  |            |  |   |  |
| ANGULAR TOL   |  | ± °   |  |   |  |            |  |   |  |
| DRAFT WHERE APPLICABLE MUST REMAIN WITHIN DIMENSIONS  |  |       |  | FIRST ANGLE PROJECTION  |  | DRAWING    |  | SERIES  |  |
|   |  |       |  |  |  | A3-SIZE    |  | 121050  |  |
| DOCUMENT STATUS   |  | P1    |  | RELEASE DATE  |  | 2022/07/19 |  | 09:04:35  |  |
|   |  | 9     |  | 8   |  | 7          |  | 6   |  |
|   |  | 5     |  | 4   |  | 3          |  | 2   |  |
|   |  | 1     |  |   |  |            |  |   |  |

TABLE 3 - PART LIST

| Pos. | Molex PN:  | Engineering No.: |
|------|------------|------------------|
| 4961 | 2210506229 | E452N4N20011C45  |
| 4962 | 2210506230 | E452N4N20011C4A  |
| 4963 | 2210506231 | E452N4N20011C4B  |
| 4964 | 2210506232 | E452N4N20011C4C  |
| 4965 | 2210506233 | E452N4N20011C4D  |
| 4966 | 2210506234 | E452N4N20011C4E  |
| 4967 | 2210506235 | E452N4N20011C4G  |
| 4968 | 2210506236 | E452N4N20011C4H  |
| 4969 | 2210506237 | E452N4N20011C4K  |
| 4970 | 2210506238 | E452N4N20011C4L  |
| 4971 | 2210506239 | E452N4N20011C4M  |
| 4972 | 2210506244 | E452N4N20011E05  |
| 4973 | 2210506259 | E452N4N20011R05  |
| 4974 | 2210506270 | E452N4N20011R21  |
| 4975 | 2210506271 | E452N4N20011R22  |
| 4976 | 2210506272 | E452N4N20011R23  |
| 4977 | 2210506273 | E452N4N20011R24  |
| 4978 | 2210506274 | E452N4N20011R25  |
| 4979 | 2210506275 | E452N4N20011R2A  |
| 4980 | 2210506276 | E452N4N20011R2B  |
| 4981 | 2210506277 | E452N4N20011R2C  |
| 4982 | 2210506278 | E452N4N20011R2D  |
| 4983 | 2210506279 | E452N4N20011R2E  |
| 4984 | 2210506280 | E452N4N20011R2G  |
| 4985 | 2210506281 | E452N4N20011R2H  |
| 4986 | 2210506282 | E452N4N20011R2K  |
| 4987 | 2210506283 | E452N4N20011R2L  |
| 4988 | 2210506284 | E452N4N20011R2M  |
| 4989 | 2210506285 | E452N4N20011S01  |
| 4990 | 2210506286 | E452N4N20011S02  |
| 4991 | 2210506287 | E452N4N20011S03  |
| 4992 | 2210506288 | E452N4N20011S04  |
| 4993 | 2210506289 | E452N4N20011S05  |
| 4994 | 2210506290 | E452N4N20011S0A  |
| 4995 | 2210506291 | E452N4N20011S0B  |
| 4996 | 2210506292 | E452N4N20011S0C  |
| 4997 | 2210506293 | E452N4N20011S0D  |
| 4998 | 2210506294 | E452N4N20011S0E  |
| 4999 | 2210506295 | E452N4N20011S0G  |
| 5000 | 2210506296 | E452N4N20011S0H  |

| Pos. | Molex PN:  | Engineering No.: |
|------|------------|------------------|
| 5001 | 2210506297 | E452N4N20011S0K  |
| 5002 | 2210506298 | E452N4N20011S0L  |
| 5003 | 2210506299 | E452N4N20011S0M  |
| 5004 | 2210506300 | E452N4N30011000  |
| 5005 | 2210506301 | E452N4N30011A11  |
| 5006 | 2210506302 | E452N4N30011A12  |
| 5007 | 2210506303 | E452N4N30011A13  |
| 5008 | 2210506304 | E452N4N30011A14  |
| 5009 | 2210506305 | E452N4N30011A15  |
| 5010 | 2210506306 | E452N4N30011A1A  |
| 5011 | 2210506307 | E452N4N30011A1B  |
| 5012 | 2210506308 | E452N4N30011A1C  |
| 5013 | 2210506309 | E452N4N30011A1D  |
| 5014 | 2210506310 | E452N4N30011A1E  |
| 5015 | 2210506311 | E452N4N30011A1G  |
| 5016 | 2210506312 | E452N4N30011A1H  |
| 5017 | 2210506313 | E452N4N30011A1K  |
| 5018 | 2210506314 | E452N4N30011A1L  |
| 5019 | 2210506315 | E452N4N30011A1M  |
| 5020 | 2210506316 | E452N4N30011C31  |
| 5021 | 2210506317 | E452N4N30011C32  |
| 5022 | 2210506318 | E452N4N30011C33  |
| 5023 | 2210506319 | E452N4N30011C34  |
| 5024 | 2210506320 | E452N4N30011C35  |
| 5025 | 2210506321 | E452N4N30011C3A  |
| 5026 | 2210506322 | E452N4N30011C3B  |
| 5027 | 2210506323 | E452N4N30011C3C  |
| 5028 | 2210506324 | E452N4N30011C3D  |
| 5029 | 2210506325 | E452N4N30011C3E  |
| 5030 | 2210506326 | E452N4N30011C3G  |
| 5031 | 2210506327 | E452N4N30011C3H  |
| 5032 | 2210506328 | E452N4N30011C3K  |
| 5033 | 2210506329 | E452N4N30011C3L  |
| 5034 | 2210506330 | E452N4N30011C3M  |
| 5035 | 2210506331 | E452N4N30011C41  |
| 5036 | 2210506332 | E452N4N30011C42  |
| 5037 | 2210506333 | E452N4N30011C43  |
| 5038 | 2210506334 | E452N4N30011C44  |
| 5039 | 2210506335 | E452N4N30011C45  |
| 5040 | 2210506336 | E452N4N30011C4A  |

| Pos. | Molex PN:  | Engineering No.: |
|------|------------|------------------|
| 5041 | 2210506337 | E452N4N30011C4B  |
| 5042 | 2210506338 | E452N4N30011C4C  |
| 5043 | 2210506339 | E452N4N30011C4D  |
| 5044 | 2210506340 | E452N4N30011C4E  |
| 5045 | 2210506341 | E452N4N30011C4G  |
| 5046 | 2210506342 | E452N4N30011C4H  |
| 5047 | 2210506343 | E452N4N30011C4K  |
| 5048 | 2210506344 | E452N4N30011C4L  |
| 5049 | 2210506345 | E452N4N30011C4M  |
| 5050 | 2210506350 | E452N4N30011E05  |
| 5051 | 2210506365 | E452N4N30011R05  |
| 5052 | 2210506376 | E452N4N30011R21  |
| 5053 | 2210506377 | E452N4N30011R22  |
| 5054 | 2210506378 | E452N4N30011R23  |
| 5055 | 2210506379 | E452N4N30011R24  |
| 5056 | 2210506380 | E452N4N30011R25  |
| 5057 | 2210506381 | E452N4N30011R2A  |
| 5058 | 2210506382 | E452N4N30011R2B  |
| 5059 | 2210506383 | E452N4N30011R2C  |
| 5060 | 2210506384 | E452N4N30011R2D  |
| 5061 | 2210506385 | E452N4N30011R2E  |
| 5062 | 2210506386 | E452N4N30011R2G  |
| 5063 | 2210506387 | E452N4N30011R2H  |
| 5064 | 2210506388 | E452N4N30011R2K  |
| 5065 | 2210506389 | E452N4N30011R2L  |
| 5066 | 2210506390 | E452N4N30011R2M  |
| 5067 | 2210506391 | E452N4N30011S01  |
| 5068 | 2210506392 | E452N4N30011S02  |
| 5069 | 2210506393 | E452N4N30011S03  |
| 5070 | 2210506394 | E452N4N30011S04  |
| 5071 | 2210506395 | E452N4N30011S05  |
| 5072 | 2210506396 | E452N4N30011S0A  |
| 5073 | 2210506397 | E452N4N30011S0B  |
| 5074 | 2210506398 | E452N4N30011S0C  |
| 5075 | 2210506399 | E452N4N30011S0D  |
| 5076 | 2210506400 | E452N4N30011S0E  |
| 5077 | 2210506401 | E452N4N30011S0G  |
| 5078 | 2210506402 | E452N4N30011S0H  |
| 5079 | 2210506403 | E452N4N30011S0K  |
| 5080 | 2210506404 | E452N4N30011S0L  |

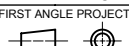
| Pos. | Molex PN:  | Engineering No.: |
|------|------------|------------------|
| 5081 | 2210506405 | E452N4N30011S0M  |
| 5082 | 2210506406 | E452N4N50011000  |
| 5083 | 2210506407 | E452N4N50011A11  |
| 5084 | 2210506408 | E452N4N50011A12  |
| 5085 | 2210506409 | E452N4N50011A13  |
| 5086 | 2210506410 | E452N4N50011A14  |
| 5087 | 2210506411 | E452N4N50011A15  |
| 5088 | 2210506412 | E452N4N50011A1A  |
| 5089 | 2210506413 | E452N4N50011A1B  |
| 5090 | 2210506414 | E452N4N50011A1C  |
| 5091 | 2210506415 | E452N4N50011A1D  |
| 5092 | 2210506416 | E452N4N50011A1E  |
| 5093 | 2210506417 | E452N4N50011A1G  |
| 5094 | 2210506418 | E452N4N50011A1H  |
| 5095 | 2210506419 | E452N4N50011A1K  |
| 5096 | 2210506420 | E452N4N50011A1L  |
| 5097 | 2210506421 | E452N4N50011A1M  |
| 5098 | 2210506422 | E452N4N50011C31  |
| 5099 | 2210506423 | E452N4N50011C32  |
| 5100 | 2210506424 | E452N4N50011C33  |
| 5101 | 2210506425 | E452N4N50011C34  |
| 5102 | 2210506426 | E452N4N50011C35  |
| 5103 | 2210506427 | E452N4N50011C3A  |
| 5104 | 2210506428 | E452N4N50011C3B  |
| 5105 | 2210506429 | E452N4N50011C3C  |
| 5106 | 2210506430 | E452N4N50011C3D  |
| 5107 | 2210506431 | E452N4N50011C3E  |
| 5108 | 2210506432 | E452N4N50011C3G  |
| 5109 | 2210506433 | E452N4N50011C3H  |
| 5110 | 2210506434 | E452N4N50011C3K  |
| 5111 | 2210506435 | E452N4N50011C3L  |
| 5112 | 2210506436 | E452N4N50011C3M  |
| 5113 | 2210506437 | E452N4N50011C41  |
| 5114 | 2210506438 | E452N4N50011C42  |
| 5115 | 2210506439 | E452N4N50011C43  |
| 5116 | 2210506440 | E452N4N50011C44  |
| 5117 | 2210506441 | E452N4N50011C45  |
| 5118 | 2210506442 | E452N4N50011C4A  |
| 5119 | 2210506443 | E452N4N50011C4B  |
| 5120 | 2210506444 | E452N4N50011C4C  |

|   |  |       |  |   |  |                 |  |   |  |
|---|--|-------|--|---|--|-----------------|--|---|--|
| THIS DRAWING CONTAINS INFORMATION THAT IS PROPRIETARY TO MOLEX ELECTRONIC TECHNOLOGIES, LLC AND SHOULD NOT BE USED WITHOUT WRITTEN PERMISSION |  |       |  |   |  |                 |  |   |  |
| DIMENSION UNITS   |  | SCALE |  | CURRENT REV DESC: REVISION CREATED FOR REMOVING PRE-RELEASE STAMP |  |                 |  | <br>E452XXXXXXXXXX<br>DIN FORM A EN 175301-803 |  |
| mm  |  | NTS   |  |   |  |                 |  |   |  |
| GENERAL TOLERANCES (UNLESS SPECIFIED)   |  |       |  | EC NO: 714567   |  | 2022/07/18      |  | PRODUCT CUSTOMER DRAWING  |  |
|   |  |       |  | DRWN: SUGEEB  |  | 2022/07/19      |  |   |  |
|   |  |       |  | CHK'D: GGA  |  | 2022/07/19      |  | DOCUMENT NUMBER<br><b>SD-121050-001</b>   |  |
|   |  |       |  | APPR: GGA   |  | 2022/07/19      |  |   |  |
|   |  |       |  | INITIAL REVISION:   |  | 2012/08/27      |  | DOC TYPE<br>PSD   |  |
|   |  |       |  | DRWN: JMARSZALEK  |  | 2012/08/27      |  |   |  |
|   |  |       |  | APPR: MDYSZEWSKA  |  | 2012/08/20      |  | DOC PART<br>001   |  |
|   |  |       |  |   |  |                 |  |   |  |
|   |  |       |  | FIRST ANGLE PROJECTION  |  | DRAWING         |  | REVISION<br>E1  |  |
|   |  |       |  | DRAFT WHERE APPLICABLE MUST REMAIN WITHIN DIMENSIONS              |  | A3-SIZE         |  |   |  |
|   |  |       |  | SERIES  |  | MATERIAL NUMBER |  | CUSTOMER<br>GENERAL MARKET  |  |
|   |  |       |  | 121050  |  | SEE TABLE       |  |   |  |
|   |  |       |  |   |  |                 |  | SHEET NUMBER<br>35 OF 41  |  |
|   |  |       |  |   |  |                 |  |   |  |

TABLE 3 - PART LIST

| Pos. | Molex PN:  | Engineering No.: |
|------|------------|------------------|
| 5121 | 2210506445 | E452N4N50011C4D  |
| 5122 | 2210506446 | E452N4N50011C4E  |
| 5123 | 2210506447 | E452N4N50011C4G  |
| 5124 | 2210506448 | E452N4N50011C4H  |
| 5125 | 2210506449 | E452N4N50011C4K  |
| 5126 | 2210506450 | E452N4N50011C4L  |
| 5127 | 2210506451 | E452N4N50011C4M  |
| 5128 | 2210506456 | E452N4N50011E05  |
| 5129 | 2210506471 | E452N4N50011R05  |
| 5130 | 2210506482 | E452N4N50011R21  |
| 5131 | 2210506483 | E452N4N50011R22  |
| 5132 | 2210506484 | E452N4N50011R23  |
| 5133 | 2210506485 | E452N4N50011R24  |
| 5134 | 2210506486 | E452N4N50011R25  |
| 5135 | 2210506487 | E452N4N50011R2A  |
| 5136 | 2210506488 | E452N4N50011R2B  |
| 5137 | 2210506489 | E452N4N50011R2C  |
| 5138 | 2210506490 | E452N4N50011R2D  |
| 5139 | 2210506491 | E452N4N50011R2E  |
| 5140 | 2210506492 | E452N4N50011R2G  |
| 5141 | 2210506493 | E452N4N50011R2H  |
| 5142 | 2210506494 | E452N4N50011R2K  |
| 5143 | 2210506495 | E452N4N50011R2L  |
| 5144 | 2210506496 | E452N4N50011R2M  |
| 5145 | 2210506497 | E452N4N50011S01  |
| 5146 | 2210506498 | E452N4N50011S02  |
| 5147 | 2210506499 | E452N4N50011S03  |
| 5148 | 2210506500 | E452N4N50011S04  |
| 5149 | 2210506501 | E452N4N50011S05  |
| 5150 | 2210506502 | E452N4N50011S0A  |
| 5151 | 2210506503 | E452N4N50011S0B  |
| 5152 | 2210506504 | E452N4N50011S0C  |
| 5153 | 2210506505 | E452N4N50011S0D  |
| 5154 | 2210506506 | E452N4N50011S0E  |
| 5155 | 2210506507 | E452N4N50011S0G  |
| 5156 | 2210506508 | E452N4N50011S0H  |
| 5157 | 2210506509 | E452N4N50011S0K  |
| 5158 | 2210506510 | E452N4N50011S0L  |
| 5159 | 2210506511 | E452N4N50011S0M  |
| 5160 | 2210506512 | E452P2N10011000  |

| Pos. | Molex PN:  | Engineering No.: |
|------|------------|------------------|
| 5161 | 2210506513 | E452P2N10011A11  |
| 5162 | 2210506514 | E452P2N10011A12  |
| 5163 | 2210506515 | E452P2N10011A13  |
| 5164 | 2210506516 | E452P2N10011A14  |
| 5165 | 2210506517 | E452P2N10011A15  |
| 5166 | 2210506518 | E452P2N10011A1A  |
| 5167 | 2210506519 | E452P2N10011A1B  |
| 5168 | 2210506520 | E452P2N10011A1C  |
| 5169 | 2210506521 | E452P2N10011A1D  |
| 5170 | 2210506522 | E452P2N10011A1E  |
| 5171 | 2210506523 | E452P2N10011A1G  |
| 5172 | 2210506524 | E452P2N10011A1H  |
| 5173 | 2210506525 | E452P2N10011A1K  |
| 5174 | 2210506526 | E452P2N10011A1L  |
| 5175 | 2210506527 | E452P2N10011A1M  |
| 5176 | 2210506528 | E452P2N10011C31  |
| 5177 | 2210506529 | E452P2N10011C32  |
| 5178 | 2210506530 | E452P2N10011C33  |
| 5179 | 2210506531 | E452P2N10011C34  |
| 5180 | 2210506532 | E452P2N10011C35  |
| 5181 | 2210506533 | E452P2N10011C3A  |
| 5182 | 2210506534 | E452P2N10011C3C  |
| 5183 | 2210506535 | E452P2N10011C3D  |
| 5184 | 2210506536 | E452P2N10011C3E  |
| 5185 | 2210506537 | E452P2N10011C3G  |
| 5186 | 2210506538 | E452P2N10011C3H  |
| 5187 | 2210506539 | E452P2N10011C3K  |
| 5188 | 2210506540 | E452P2N10011C3L  |
| 5189 | 2210506541 | E452P2N10011C3M  |
| 5190 | 2210506542 | E452P2N10011C41  |
| 5191 | 2210506543 | E452P2N10011C42  |
| 5192 | 2210506544 | E452P2N10011C43  |
| 5193 | 2210506545 | E452P2N10011C44  |
| 5194 | 2210506546 | E452P2N10011C45  |
| 5195 | 2210506547 | E452P2N10011C4A  |
| 5196 | 2210506548 | E452P2N10011C4B  |
| 5197 | 2210506549 | E452P2N10011C4C  |
| 5198 | 2210506550 | E452P2N10011C4D  |
| 5199 | 2210506551 | E452P2N10011C4E  |
| 5200 | 2210506552 | E452P2N10011C4G  |

| Pos. | Molex PN:  | Engineering No.: |
|------|------------|------------------|
| 5201 | 2210506553 | E452P2N10011C4K  |
| 5202 | 2210506554 | E452P2N10011C4L  |
| 5203 | 2210506555 | E452P2N10011C4M  |
| 5204 | 2210506560 | E452P2N10011E05  |
| 5205 | 2210506575 | E452P2N10011R05  |
| 5206 | 2210506586 | E452P2N10011R21  |
| 5207 | 2210506587 | E452P2N10011R22  |
| 5208 | 2210506588 | E452P2N10011R23  |
| 5209 | 2210506589 | E452P2N10011R24  |
| 5210 | 2210506590 | E452P2N10011R25  |
| 5211 | 2210506591 | E452P2N10011R2A  |
| 5212 | 2210506592 | E452P2N10011R2B  |
| 5213 | 2210506593 | E452P2N10011R2C  |
| 5214 | 2210506594 | E452P2N10011R2D  |
| 5215 | 2210506595 | E452P2N10011R2E  |
| 5216 | 2210506596 | E452P2N10011R2G  |
| 5217 | 2210506597 | E452P2N10011R2H  |
| 5218 | 2210506598 | E452P2N10011R2K  |
| 5219 | 2210506599 | E452P2N10011R2L  |
| 5220 | 2210506600 | E452P2N10011R2M  |
| 5221 | 2210506601 | E452P2N10011S01  |
| 5222 | 2210506602 | E452P2N10011S02  |
| 5223 | 2210506603 | E452P2N10011S03  |
| 5224 | 2210506604 | E452P2N10011S04  |
| 5225 | 2210506605 | E452P2N10011S05  |
| 5226 | 2210506606 | E452P2N10011S0A  |
| 5227 | 2210506607 | E452P2N10011S0B  |
| 5228 | 2210506608 | E452P2N10011S0C  |
| 5229 | 2210506609 | E452P2N10011S0D  |
| 5230 | 2210506610 | E452P2N10011S0E  |
| 5231 | 2210506611 | E452P2N10011S0G  |
| 5232 | 2210506612 | E452P2N10011S0H  |
| 5233 | 2210506613 | E452P2N10011S0K  |
| 5234 | 2210506614 | E452P2N10011S0L  |
| 5235 | 2210506615 | E452P2N10011S0M  |
| 5236 | 2210506616 | E452P2N10K11000  |
| 5237 | 2210506617 | E452P2N10K11A11  |
| 5238 | 2210506618 | E452P2N10K11A12  |
| 5239 | 2210506619 | E452P2N10K11A13  |
| 5240 | 2210506620 | E452P2N10K11A14  |

| Pos. | Molex PN:  | Engineering No.: |
|------|------------|------------------|
| 5241 | 2210506621 | E452P2N10K11A15  |
| 5242 | 2210506622 | E452P2N10K11A1A  |
| 5243 | 2210506623 | E452P2N10K11A1B  |
| 5244 | 2210506624 | E452P2N10K11A1C  |
| 5245 | 2210506625 | E452P2N10K11A1D  |
| 5246 | 2210506626 | E452P2N10K11A1E  |
| 5247 | 2210506627 | E452P2N10K11A1G  |
| 5248 | 2210506628 | E452P2N10K11A1H  |
| 5249 | 2210506629 | E452P2N10K11A1K  |
| 5250 | 2210506630 | E452P2N10K11A1L  |
| 5251 | 2210506631 | E452P2N10K11A1M  |
| 5252 | 2210506632 | E452P2N10K11C31  |
| 5253 | 2210506633 | E452P2N10K11C32  |
| 5254 | 2210506634 | E452P2N10K11C33  |
| 5255 | 2210506635 | E452P2N10K11C34  |
| 5256 | 2210506636 | E452P2N10K11C35  |
| 5257 | 2210506637 | E452P2N10K11C3A  |
| 5258 | 2210506638 | E452P2N10K11C3B  |
| 5259 | 2210506639 | E452P2N10K11C3C  |
| 5260 | 2210506640 | E452P2N10K11C3D  |
| 5261 | 2210506641 | E452P2N10K11C3E  |
| 5262 | 2210506642 | E452P2N10K11C3G  |
| 5263 | 2210506643 | E452P2N10K11C3H  |
| 5264 | 2210506644 | E452P2N10K11C3K  |
| 5265 | 2210506645 | E452P2N10K11C3L  |
| 5266 | 2210506646 | E452P2N10K11C3M  |
| 5267 | 2210506647 | E452P2N10K11C41  |
| 5268 | 2210506648 | E452P2N10K11C42  |
| 5269 | 2210506649 | E452P2N10K11C43  |
| 5270 | 2210506650 | E452P2N10K11C44  |
| 5271 | 2210506651 | E452P2N10K11C45  |
| 5272 | 2210506652 | E452P2N10K11C4A  |
| 5273 | 2210506653 | E452P2N10K11C4B  |
| 5274 | 2210506654 | E452P2N10K11C4C  |
| 5275 | 2210506655 | E452P2N10K11C4D  |
| 5276 | 2210506656 | E452P2N10K11C4E  |
| 5277 | 2210506657 | E452P2N10K11C4G  |
| 5278 | 2210506658 | E452P2N10K11C4K  |
| 5279 | 2210506659 | E452P2N10K11C4L  |
| 5280 | 2210506660 | E452P2N10K11C4M  |

|   |  |       |  |   |  |            |  |   |  |
|---|--|-------|--|---|--|------------|--|---|--|
| THIS DRAWING CONTAINS INFORMATION THAT IS PROPRIETARY TO MOLEX ELECTRONIC TECHNOLOGIES, LLC AND SHOULD NOT BE USED WITHOUT WRITTEN PERMISSION |  |       |  |   |  |            |  |   |  |
| DIMENSION UNITS   |  | SCALE |  | CURRENT REV DESC: REVISION CREATED FOR REMOVING PRE-RELEASE STAMP                     |  |            |  | <br>E452XXXXXXXXXX<br>DIN FORM A EN 175301-803 |  |
| mm  |  | NTS   |  |   |  |            |  |   |  |
| GENERAL TOLERANCES (UNLESS SPECIFIED)   |  |       |  |   |  |            |  |   |  |
|   |  | MM    |  | INCH  |  |            |  |   |  |
| 4 PLACES  |  | ±     |  | ±   |  |            |  |   |  |
| 3 PLACES  |  | ±     |  | ±   |  |            |  |   |  |
| 2 PLACES  |  | ±     |  | ±   |  |            |  |   |  |
| 1 PLACE   |  | ±     |  | ±   |  |            |  |   |  |
| 0 PLACES  |  | ±     |  | ±   |  |            |  |   |  |
| ANGULAR TOL   |  | ± °   |  | ± °   |  |            |  |   |  |
| DRAFT WHERE APPLICABLE MUST REMAIN WITHIN DIMENSIONS  |  |       |  | FIRST ANGLE PROJECTION  |  | DRAWING    |  | SERIES  |  |
|   |  |       |  |  |  | A3-SIZE    |  | 121050  |  |
| DOCUMENT STATUS   |  | P1    |  | RELEASE DATE  |  | 2022/07/19 |  | 09:04:35  |  |
|   |  | 9     |  | 8   |  | 7          |  | 6   |  |
|   |  | 5     |  | 4   |  | 3          |  | 2   |  |
|   |  | 1     |  |   |  |            |  |   |  |



TABLE 3 - PART LIST

| Pos. | Molex PN:  | Engineering No.: |
|------|------------|------------------|
| 5281 | 2210506665 | E452P2N10K11E05  |
| 5282 | 2210506680 | E452P2N10K11R05  |
| 5283 | 2210506691 | E452P2N10K11R21  |
| 5284 | 2210506692 | E452P2N10K11R22  |
| 5285 | 2210506693 | E452P2N10K11R23  |
| 5286 | 2210506694 | E452P2N10K11R24  |
| 5287 | 2210506695 | E452P2N10K11R25  |
| 5288 | 2210506696 | E452P2N10K11R2A  |
| 5289 | 2210506697 | E452P2N10K11R2B  |
| 5290 | 2210506698 | E452P2N10K11R2C  |
| 5291 | 2210506699 | E452P2N10K11R2D  |
| 5292 | 2210506700 | E452P2N10K11R2E  |
| 5293 | 2210506701 | E452P2N10K11R2G  |
| 5294 | 2210506702 | E452P2N10K11R2H  |
| 5295 | 2210506703 | E452P2N10K11R2K  |
| 5296 | 2210506704 | E452P2N10K11R2L  |
| 5297 | 2210506705 | E452P2N10K11R2M  |
| 5298 | 2210506706 | E452P2N10K11S01  |
| 5299 | 2210506707 | E452P2N10K11S02  |
| 5300 | 2210506708 | E452P2N10K11S03  |
| 5301 | 2210506709 | E452P2N10K11S04  |
| 5302 | 2210506710 | E452P2N10K11S05  |
| 5303 | 2210506711 | E452P2N10K11S0A  |
| 5304 | 2210506712 | E452P2N10K11S0B  |
| 5305 | 2210506713 | E452P2N10K11S0C  |
| 5306 | 2210506714 | E452P2N10K11S0D  |
| 5307 | 2210506715 | E452P2N10K11S0E  |
| 5308 | 2210506716 | E452P2N10K11S0G  |
| 5309 | 2210506717 | E452P2N10K11S0K  |
| 5310 | 2210506718 | E452P2N10K11S0L  |
| 5311 | 2210506719 | E452P2N10K11S0M  |
| 5312 | 2210506720 | E452P2N15011000  |
| 5313 | 2210506721 | E452P2N15011A11  |
| 5314 | 2210506722 | E452P2N15011A12  |
| 5315 | 2210506723 | E452P2N15011A13  |
| 5316 | 2210506724 | E452P2N15011A14  |
| 5317 | 2210506725 | E452P2N15011A15  |
| 5318 | 2210506726 | E452P2N15011A1A  |
| 5319 | 2210506727 | E452P2N15011A1B  |
| 5320 | 2210506728 | E452P2N15011A1C  |

| Pos. | Molex PN:  | Engineering No.: |
|------|------------|------------------|
| 5321 | 2210506729 | E452P2N15011A1D  |
| 5322 | 2210506730 | E452P2N15011A1E  |
| 5323 | 2210506731 | E452P2N15011A1G  |
| 5324 | 2210506732 | E452P2N15011A1H  |
| 5325 | 2210506733 | E452P2N15011A1K  |
| 5326 | 2210506734 | E452P2N15011A1L  |
| 5327 | 2210506735 | E452P2N15011A1M  |
| 5328 | 2210506736 | E452P2N15011C31  |
| 5329 | 2210506737 | E452P2N15011C32  |
| 5330 | 2210506738 | E452P2N15011C33  |
| 5331 | 2210506739 | E452P2N15011C34  |
| 5332 | 2210506740 | E452P2N15011C35  |
| 5333 | 2210506741 | E452P2N15011C3A  |
| 5334 | 2210506742 | E452P2N15011C3B  |
| 5335 | 2210506743 | E452P2N15011C3C  |
| 5336 | 2210506744 | E452P2N15011C3D  |
| 5337 | 2210506745 | E452P2N15011C3E  |
| 5338 | 2210506746 | E452P2N15011C3G  |
| 5339 | 2210506747 | E452P2N15011C3H  |
| 5340 | 2210506748 | E452P2N15011C3K  |
| 5341 | 2210506749 | E452P2N15011C3L  |
| 5342 | 2210506750 | E452P2N15011C3M  |
| 5343 | 2210506751 | E452P2N15011C41  |
| 5344 | 2210506752 | E452P2N15011C42  |
| 5345 | 2210506753 | E452P2N15011C43  |
| 5346 | 2210506754 | E452P2N15011C44  |
| 5347 | 2210506755 | E452P2N15011C45  |
| 5348 | 2210506756 | E452P2N15011C4A  |
| 5349 | 2210506757 | E452P2N15011C4B  |
| 5350 | 2210506758 | E452P2N15011C4C  |
| 5351 | 2210506759 | E452P2N15011C4D  |
| 5352 | 2210506760 | E452P2N15011C4E  |
| 5353 | 2210506761 | E452P2N15011C4G  |
| 5354 | 2210506762 | E452P2N15011C4H  |
| 5355 | 2210506763 | E452P2N15011C4K  |
| 5356 | 2210506764 | E452P2N15011C4L  |
| 5357 | 2210506765 | E452P2N15011C4M  |
| 5358 | 2210506770 | E452P2N15011E05  |
| 5359 | 2210506785 | E452P2N15011R05  |
| 5360 | 2210506796 | E452P2N15011R21  |

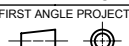
| Pos. | Molex PN:  | Engineering No.: |
|------|------------|------------------|
| 5361 | 2210506797 | E452P2N15011R22  |
| 5362 | 2210506798 | E452P2N15011R23  |
| 5363 | 2210506799 | E452P2N15011R24  |
| 5364 | 2210506800 | E452P2N15011R25  |
| 5365 | 2210506801 | E452P2N15011R2A  |
| 5366 | 2210506802 | E452P2N15011R2B  |
| 5367 | 2210506803 | E452P2N15011R2C  |
| 5368 | 2210506804 | E452P2N15011R2D  |
| 5369 | 2210506805 | E452P2N15011R2E  |
| 5370 | 2210506806 | E452P2N15011R2G  |
| 5371 | 2210506807 | E452P2N15011R2H  |
| 5372 | 2210506808 | E452P2N15011R2K  |
| 5373 | 2210506809 | E452P2N15011R2L  |
| 5374 | 2210506810 | E452P2N15011R2M  |
| 5375 | 2210506811 | E452P2N15011S01  |
| 5376 | 2210506812 | E452P2N15011S02  |
| 5377 | 2210506813 | E452P2N15011S03  |
| 5378 | 2210506814 | E452P2N15011S04  |
| 5379 | 2210506815 | E452P2N15011S05  |
| 5380 | 2210506816 | E452P2N15011S0A  |
| 5381 | 2210506817 | E452P2N15011S0B  |
| 5382 | 2210506818 | E452P2N15011S0C  |
| 5383 | 2210506819 | E452P2N15011S0D  |
| 5384 | 2210506820 | E452P2N15011S0E  |
| 5385 | 2210506821 | E452P2N15011S0G  |
| 5386 | 2210506822 | E452P2N15011S0H  |
| 5387 | 2210506823 | E452P2N15011S0K  |
| 5388 | 2210506824 | E452P2N15011S0L  |
| 5389 | 2210506825 | E452P2N15011S0M  |
| 5390 | 2210506826 | E452P2N20011000  |
| 5391 | 2210506827 | E452P2N20011A11  |
| 5392 | 2210506828 | E452P2N20011A13  |
| 5393 | 2210506829 | E452P2N20011A14  |
| 5394 | 2210506830 | E452P2N20011A15  |
| 5395 | 2210506831 | E452P2N20011A1A  |
| 5396 | 2210506832 | E452P2N20011A1B  |
| 5397 | 2210506833 | E452P2N20011A1C  |
| 5398 | 2210506834 | E452P2N20011A1D  |
| 5399 | 2210506835 | E452P2N20011A1E  |
| 5400 | 2210506836 | E452P2N20011A1G  |

| Pos. | Molex PN:  | Engineering No.: |
|------|------------|------------------|
| 5401 | 2210506837 | E452P2N20011A1H  |
| 5402 | 2210506838 | E452P2N20011A1K  |
| 5403 | 2210506839 | E452P2N20011A1L  |
| 5404 | 2210506840 | E452P2N20011A1M  |
| 5405 | 2210506841 | E452P2N20011C31  |
| 5406 | 2210506842 | E452P2N20011C32  |
| 5407 | 2210506843 | E452P2N20011C33  |
| 5408 | 2210506844 | E452P2N20011C34  |
| 5409 | 2210506845 | E452P2N20011C35  |
| 5410 | 2210506846 | E452P2N20011C3A  |
| 5411 | 2210506847 | E452P2N20011C3C  |
| 5412 | 2210506848 | E452P2N20011C3D  |
| 5413 | 2210506849 | E452P2N20011C3E  |
| 5414 | 2210506850 | E452P2N20011C3G  |
| 5415 | 2210506851 | E452P2N20011C3H  |
| 5416 | 2210506852 | E452P2N20011C3K  |
| 5417 | 2210506853 | E452P2N20011C3L  |
| 5418 | 2210506854 | E452P2N20011C3M  |
| 5419 | 2210506855 | E452P2N20011C41  |
| 5420 | 2210506856 | E452P2N20011C43  |
| 5421 | 2210506857 | E452P2N20011C44  |
| 5422 | 2210506858 | E452P2N20011C45  |
| 5423 | 2210506859 | E452P2N20011C4A  |
| 5424 | 2210506860 | E452P2N20011C4B  |
| 5425 | 2210506861 | E452P2N20011C4C  |
| 5426 | 2210506862 | E452P2N20011C4D  |
| 5427 | 2210506863 | E452P2N20011C4E  |
| 5428 | 2210506864 | E452P2N20011C4G  |
| 5429 | 2210506865 | E452P2N20011C4K  |
| 5430 | 2210506866 | E452P2N20011C4L  |
| 5431 | 2210506867 | E452P2N20011C4M  |
| 5432 | 2210506872 | E452P2N20011E05  |
| 5433 | 2210506887 | E452P2N20011R05  |
| 5434 | 2210506898 | E452P2N20011R21  |
| 5435 | 2210506899 | E452P2N20011R22  |
| 5436 | 2210506900 | E452P2N20011R23  |
| 5437 | 2210506901 | E452P2N20011R24  |
| 5438 | 2210506902 | E452P2N20011R25  |
| 5439 | 2210506903 | E452P2N20011R2A  |
| 5440 | 2210506904 | E452P2N20011R2B  |



|   |  |       |  |   |  |            |  |   |  |
|---|--|-------|--|---|--|------------|--|---|--|
| THIS DRAWING CONTAINS INFORMATION THAT IS PROPRIETARY TO MOLEX ELECTRONIC TECHNOLOGIES, LLC AND SHOULD NOT BE USED WITHOUT WRITTEN PERMISSION |  |       |  |   |  |            |  |   |  |
| DIMENSION UNITS   |  | SCALE |  | CURRENT REV DESC: REVISION CREATED FOR REMOVING PRE-RELEASE STAMP                     |  |            |  | <br>E452XXXXXXXXXX<br>DIN FORM A EN 175301-803 |  |
| mm  |  | NTS   |  |   |  |            |  |   |  |
| GENERAL TOLERANCES (UNLESS SPECIFIED)   |  |       |  |   |  |            |  |   |  |
|   |  | MM    |  | INCH  |  |            |  |   |  |
| 4 PLACES ±  |  | ±     |  | ±   |  |            |  |   |  |
| 3 PLACES ±  |  | ±     |  | ±   |  |            |  |   |  |
| 2 PLACES ±  |  | ±     |  | ±   |  |            |  |   |  |
| 1 PLACE ±   |  | ±     |  | ±   |  |            |  |   |  |
| 0 PLACES ±  |  | ±     |  | ±   |  |            |  |   |  |
| ANGULAR TOL ± °   |  | ± °   |  | ± °   |  |            |  |   |  |
| DRAFT WHERE APPLICABLE MUST REMAIN WITHIN DIMENSIONS  |  |       |  | FIRST ANGLE PROJECTION  |  | DRAWING    |  | SERIES  |  |
|   |  |       |  |  |  | A3-SIZE    |  | 121050  |  |
| DOCUMENT STATUS   |  | P1    |  | RELEASE DATE  |  | 2022/07/19 |  | 09:04:35  |  |
|   |  | 9     |  | 8   |  | 7          |  | 6   |  |
|   |  | 5     |  | 4   |  | 3          |  | 2   |  |
|   |  | 1     |  |   |  |            |  |   |  |



TABLE 3 - PART LIST

| Pos. | Molex PN:  | Engineering No.: |
|------|------------|------------------|
| 5441 | 2210506905 | E452P2N20011R2C  |
| 5442 | 2210506906 | E452P2N20011R2D  |
| 5443 | 2210506907 | E452P2N20011R2E  |
| 5444 | 2210506908 | E452P2N20011R2G  |
| 5445 | 2210506909 | E452P2N20011R2H  |
| 5446 | 2210506910 | E452P2N20011R2K  |
| 5447 | 2210506911 | E452P2N20011R2L  |
| 5448 | 2210506912 | E452P2N20011R2M  |
| 5449 | 2210506913 | E452P2N20011S01  |
| 5450 | 2210506914 | E452P2N20011S02  |
| 5451 | 2210506915 | E452P2N20011S03  |
| 5452 | 2210506916 | E452P2N20011S04  |
| 5453 | 2210506917 | E452P2N20011S05  |
| 5454 | 2210506918 | E452P2N20011S0A  |
| 5455 | 2210506919 | E452P2N20011S0C  |
| 5456 | 2210506920 | E452P2N20011S0D  |
| 5457 | 2210506921 | E452P2N20011S0E  |
| 5458 | 2210506922 | E452P2N20011S0G  |
| 5459 | 2210506923 | E452P2N20011S0H  |
| 5460 | 2210506924 | E452P2N20011S0K  |
| 5461 | 2210506925 | E452P2N20011S0L  |
| 5462 | 2210506926 | E452P2N20011S0M  |
| 5463 | 2210506927 | E452P2N30011000  |
| 5464 | 2210506928 | E452P2N30011A11  |
| 5465 | 2210506929 | E452P2N30011A12  |
| 5466 | 2210506930 | E452P2N30011A13  |
| 5467 | 2210506931 | E452P2N30011A14  |
| 5468 | 2210506932 | E452P2N30011A15  |
| 5469 | 2210506933 | E452P2N30011A1A  |
| 5470 | 2210506934 | E452P2N30011A1B  |
| 5471 | 2210506935 | E452P2N30011A1C  |
| 5472 | 2210506936 | E452P2N30011A1D  |
| 5473 | 2210506937 | E452P2N30011A1E  |
| 5474 | 2210506938 | E452P2N30011A1G  |
| 5475 | 2210506939 | E452P2N30011A1H  |
| 5476 | 2210506940 | E452P2N30011A1K  |
| 5477 | 2210506941 | E452P2N30011A1L  |
| 5478 | 2210506942 | E452P2N30011A1M  |
| 5479 | 2210506943 | E452P2N30011C31  |
| 5480 | 2210506944 | E452P2N30011C32  |

| Pos. | Molex PN:  | Engineering No.: |
|------|------------|------------------|
| 5481 | 2210506945 | E452P2N30011C33  |
| 5482 | 2210506946 | E452P2N30011C34  |
| 5483 | 2210506947 | E452P2N30011C35  |
| 5484 | 2210506948 | E452P2N30011C3A  |
| 5485 | 2210506949 | E452P2N30011C3B  |
| 5486 | 2210506950 | E452P2N30011C3C  |
| 5487 | 2210506951 | E452P2N30011C3D  |
| 5488 | 2210506952 | E452P2N30011C3E  |
| 5489 | 2210506953 | E452P2N30011C3G  |
| 5490 | 2210506954 | E452P2N30011C3H  |
| 5491 | 2210506955 | E452P2N30011C3K  |
| 5492 | 2210506956 | E452P2N30011C3L  |
| 5493 | 2210506957 | E452P2N30011C3M  |
| 5494 | 2210506958 | E452P2N30011C41  |
| 5495 | 2210506959 | E452P2N30011C42  |
| 5496 | 2210506960 | E452P2N30011C43  |
| 5497 | 2210506961 | E452P2N30011C44  |
| 5498 | 2210506962 | E452P2N30011C45  |
| 5499 | 2210506963 | E452P2N30011C4A  |
| 5500 | 2210506964 | E452P2N30011C4B  |
| 5501 | 2210506965 | E452P2N30011C4C  |
| 5502 | 2210506966 | E452P2N30011C4D  |
| 5503 | 2210506967 | E452P2N30011C4E  |
| 5504 | 2210506968 | E452P2N30011C4G  |
| 5505 | 2210506969 | E452P2N30011C4K  |
| 5506 | 2210506970 | E452P2N30011C4M  |
| 5507 | 2210506975 | E452P2N30011E05  |
| 5508 | 2210506990 | E452P2N30011R05  |
| 5509 | 2210507001 | E452P2N30011R21  |
| 5510 | 2210507002 | E452P2N30011R22  |
| 5511 | 2210507003 | E452P2N30011R23  |
| 5512 | 2210507004 | E452P2N30011R24  |
| 5513 | 2210507005 | E452P2N30011R25  |
| 5514 | 2210507006 | E452P2N30011R2A  |
| 5515 | 2210507007 | E452P2N30011R2B  |
| 5516 | 2210507008 | E452P2N30011R2C  |
| 5517 | 2210507009 | E452P2N30011R2D  |
| 5518 | 2210507010 | E452P2N30011R2E  |
| 5519 | 2210507011 | E452P2N30011R2G  |
| 5520 | 2210507012 | E452P2N30011R2H  |

| Pos. | Molex PN:  | Engineering No.: |
|------|------------|------------------|
| 5521 | 2210507013 | E452P2N30011R2K  |
| 5522 | 2210507014 | E452P2N30011R2L  |
| 5523 | 2210507015 | E452P2N30011R2M  |
| 5524 | 2210507016 | E452P2N30011S01  |
| 5525 | 2210507017 | E452P2N30011S02  |
| 5526 | 2210507018 | E452P2N30011S03  |
| 5527 | 2210507019 | E452P2N30011S04  |
| 5528 | 2210507020 | E452P2N30011S05  |
| 5529 | 2210507021 | E452P2N30011S0A  |
| 5530 | 2210507022 | E452P2N30011S0B  |
| 5531 | 2210507023 | E452P2N30011S0C  |
| 5532 | 2210507024 | E452P2N30011S0D  |
| 5533 | 2210507025 | E452P2N30011S0E  |
| 5534 | 2210507026 | E452P2N30011S0G  |
| 5535 | 2210507027 | E452P2N30011S0K  |
| 5536 | 2210507028 | E452P2N30011S0L  |
| 5537 | 2210507029 | E452P2N30011S0M  |
| 5538 | 2210507030 | E452P2N50011000  |
| 5539 | 2210507031 | E452P2N50011A11  |
| 5540 | 2210507032 | E452P2N50011A12  |
| 5541 | 2210507033 | E452P2N50011A13  |
| 5542 | 2210507034 | E452P2N50011A14  |
| 5543 | 2210507035 | E452P2N50011A15  |
| 5544 | 2210507036 | E452P2N50011A1A  |
| 5545 | 2210507037 | E452P2N50011A1B  |
| 5546 | 2210507038 | E452P2N50011A1C  |
| 5547 | 2210507039 | E452P2N50011A1D  |
| 5548 | 2210507040 | E452P2N50011A1E  |
| 5549 | 2210507041 | E452P2N50011A1G  |
| 5550 | 2210507042 | E452P2N50011A1H  |
| 5551 | 2210507043 | E452P2N50011A1K  |
| 5552 | 2210507044 | E452P2N50011A1L  |
| 5553 | 2210507045 | E452P2N50011A1M  |
| 5554 | 2210507046 | E452P2N50011C31  |
| 5555 | 2210507047 | E452P2N50011C32  |
| 5556 | 2210507048 | E452P2N50011C33  |
| 5557 | 2210507049 | E452P2N50011C34  |
| 5558 | 2210507050 | E452P2N50011C35  |
| 5559 | 2210507051 | E452P2N50011C3A  |
| 5560 | 2210507052 | E452P2N50011C3B  |

| Pos. | Molex PN:  | Engineering No.: |
|------|------------|------------------|
| 5561 | 2210507053 | E452P2N50011C3C  |
| 5562 | 2210507054 | E452P2N50011C3D  |
| 5563 | 2210507055 | E452P2N50011C3E  |
| 5564 | 2210507056 | E452P2N50011C3G  |
| 5565 | 2210507057 | E452P2N50011C3H  |
| 5566 | 2210507058 | E452P2N50011C3K  |
| 5567 | 2210507059 | E452P2N50011C3L  |
| 5568 | 2210507060 | E452P2N50011C3M  |
| 5569 | 2210507061 | E452P2N50011C41  |
| 5570 | 2210507062 | E452P2N50011C43  |
| 5571 | 2210507063 | E452P2N50011C44  |
| 5572 | 2210507064 | E452P2N50011C45  |
| 5573 | 2210507065 | E452P2N50011C4A  |
| 5574 | 2210507066 | E452P2N50011C4C  |
| 5575 | 2210507067 | E452P2N50011C4D  |
| 5576 | 2210507068 | E452P2N50011C4E  |
| 5577 | 2210507069 | E452P2N50011C4K  |
| 5578 | 2210507074 | E452P2N50011E05  |
| 5579 | 2210507089 | E452P2N50011R05  |
| 5580 | 2210507100 | E452P2N50011R21  |
| 5581 | 2210507101 | E452P2N50011R22  |
| 5582 | 2210507102 | E452P2N50011R23  |
| 5583 | 2210507103 | E452P2N50011R24  |
| 5584 | 2210507104 | E452P2N50011R25  |
| 5585 | 2210507105 | E452P2N50011R2A  |
| 5586 | 2210507106 | E452P2N50011R2B  |
| 5587 | 2210507107 | E452P2N50011R2C  |
| 5588 | 2210507108 | E452P2N50011R2D  |
| 5589 | 2210507109 | E452P2N50011R2E  |
| 5590 | 2210507110 | E452P2N50011R2G  |
| 5591 | 2210507111 | E452P2N50011R2H  |
| 5592 | 2210507112 | E452P2N50011R2K  |
| 5593 | 2210507113 | E452P2N50011R2L  |
| 5594 | 2210507114 | E452P2N50011R2M  |
| 5595 | 2210507115 | E452P2N50011S01  |
| 5596 | 2210507116 | E452P2N50011S02  |
| 5597 | 2210507117 | E452P2N50011S03  |
| 5598 | 2210507118 | E452P2N50011S04  |
| 5599 | 2210507119 | E452P2N50011S05  |
| 5600 | 2210507120 | E452P2N50011S0A  |

|   |  |       |  |   |  |                        |  |   |  |
|---|--|-------|--|---|--|------------------------|--|---|--|
| THIS DRAWING CONTAINS INFORMATION THAT IS PROPRIETARY TO MOLEX ELECTRONIC TECHNOLOGIES, LLC AND SHOULD NOT BE USED WITHOUT WRITTEN PERMISSION |  |       |  |   |  |                        |  |   |  |
| DIMENSION UNITS   |  | SCALE |  | CURRENT REV DESC: REVISION CREATED FOR REMOVING PRE-RELEASE STAMP |  |                        |  | <br>E452XXXXXXXXXX<br>DIN FORM A EN 175301-803 |  |
| mm  |  | NTS   |  |   |  |                        |  |   |  |
| GENERAL TOLERANCES (UNLESS SPECIFIED)   |  |       |  | EC NO: 714567   |  | 2022/07/18             |  | PRODUCT CUSTOMER DRAWING  |  |
|   |  |       |  | DRWN: SUGEEB  |  | 2022/07/19             |  |   |  |
|   |  |       |  | CHK'D: GGA  |  | 2022/07/19             |  | DOCUMENT NUMBER   |  |
|   |  |       |  | APPR: GGA   |  | 2022/07/19             |  |   |  |
|   |  |       |  | INITIAL REVISION:   |  |                        |  | SD-121050-001   |  |
|   |  |       |  | DRWN: JMARSZALEK  |  | 2012/08/27             |  |   |  |
|   |  |       |  | APPR: MDYSZEWSKA  |  | 2012/08/20             |  | DOC TYPE  |  |
|   |  |       |  | ANGULAR TOL   |  |                        |  | DOC PART  |  |
|   |  |       |  | DRAFT WHERE APPLICABLE MUST REMAIN WITHIN DIMENSIONS              |  | FIRST ANGLE PROJECTION |  | REVISION  |  |
|   |  |       |  |   |  | DRAWING                |  | PSD   |  |
|   |  |       |  |   |  | SERIES                 |  | 001   |  |
|   |  |       |  |   |  | MATERIAL NUMBER        |  | E1  |  |
|   |  |       |  |   |  | CUSTOMER               |  | 38 OF 41  |  |
|   |  |       |  |   |  | SEE TABLE              |  | GENERAL MARKET  |  |

TABLE 3 - PART LIST

| Pos. | Molex PN:  | Engineering No.: |
|------|------------|------------------|
| 5601 | 2210507121 | E452P2N50011S0B  |
| 5602 | 2210507122 | E452P2N50011S0C  |
| 5603 | 2210507123 | E452P2N50011S0D  |
| 5604 | 2210507124 | E452P2N50011S0E  |
| 5605 | 2210507125 | E452P2N50011S0G  |
| 5606 | 2210507126 | E452P2N50011S0K  |
| 5607 | 2210507127 | E452P2N50011S0L  |
| 5608 | 2210507128 | E452P2N50011S0M  |
| 5609 | 2210507129 | E452P3N10011000  |
| 5610 | 2210507130 | E452P3N10011A11  |
| 5611 | 2210507131 | E452P3N10011A12  |
| 5612 | 2210507132 | E452P3N10011A13  |
| 5613 | 2210507133 | E452P3N10011A14  |
| 5614 | 2210507134 | E452P3N10011A15  |
| 5615 | 2210507135 | E452P3N10011A1A  |
| 5616 | 2210507136 | E452P3N10011A1B  |
| 5617 | 2210507137 | E452P3N10011A1C  |
| 5618 | 2210507138 | E452P3N10011A1D  |
| 5619 | 2210507139 | E452P3N10011A1E  |
| 5620 | 2210507140 | E452P3N10011A1G  |
| 5621 | 2210507141 | E452P3N10011A1H  |
| 5622 | 2210507142 | E452P3N10011A1K  |
| 5623 | 2210507143 | E452P3N10011A1L  |
| 5624 | 2210507144 | E452P3N10011A1M  |
| 5625 | 2210507145 | E452P3N10011C31  |
| 5626 | 2210507146 | E452P3N10011C32  |
| 5627 | 2210507147 | E452P3N10011C33  |
| 5628 | 2210507148 | E452P3N10011C34  |
| 5629 | 2210507149 | E452P3N10011C35  |
| 5630 | 2210507150 | E452P3N10011C3A  |
| 5631 | 2210507151 | E452P3N10011C3B  |
| 5632 | 2210507152 | E452P3N10011C3C  |
| 5633 | 2210507153 | E452P3N10011C3D  |
| 5634 | 2210507154 | E452P3N10011C3E  |
| 5635 | 2210507155 | E452P3N10011C3G  |
| 5636 | 2210507156 | E452P3N10011C3H  |
| 5637 | 2210507157 | E452P3N10011C3K  |
| 5638 | 2210507158 | E452P3N10011C3L  |
| 5639 | 2210507159 | E452P3N10011C3M  |
| 5640 | 2210507160 | E452P3N10011C41  |

| Pos. | Molex PN:  | Engineering No.: |
|------|------------|------------------|
| 5641 | 2210507161 | E452P3N10011C42  |
| 5642 | 2210507162 | E452P3N10011C43  |
| 5643 | 2210507163 | E452P3N10011C44  |
| 5644 | 2210507164 | E452P3N10011C45  |
| 5645 | 2210507165 | E452P3N10011C4A  |
| 5646 | 2210507166 | E452P3N10011C4B  |
| 5647 | 2210507167 | E452P3N10011C4C  |
| 5648 | 2210507168 | E452P3N10011C4D  |
| 5649 | 2210507169 | E452P3N10011C4E  |
| 5650 | 2210507170 | E452P3N10011C4G  |
| 5651 | 2210507171 | E452P3N10011C4K  |
| 5652 | 2210507172 | E452P3N10011C4M  |
| 5653 | 2210507177 | E452P3N10011E05  |
| 5654 | 2210507192 | E452P3N10011R05  |
| 5655 | 2210507203 | E452P3N10011R21  |
| 5656 | 2210507204 | E452P3N10011R22  |
| 5657 | 2210507205 | E452P3N10011R23  |
| 5658 | 2210507206 | E452P3N10011R24  |
| 5659 | 2210507207 | E452P3N10011R25  |
| 5660 | 2210507208 | E452P3N10011R2A  |
| 5661 | 2210507209 | E452P3N10011R2C  |
| 5662 | 2210507210 | E452P3N10011R2D  |
| 5663 | 2210507211 | E452P3N10011R2G  |
| 5664 | 2210507212 | E452P3N10011R2H  |
| 5665 | 2210507213 | E452P3N10011R2K  |
| 5666 | 2210507214 | E452P3N10011R2L  |
| 5667 | 2210507215 | E452P3N10011R2M  |
| 5668 | 2210507216 | E452P3N10011S01  |
| 5669 | 2210507217 | E452P3N10011S02  |
| 5670 | 2210507218 | E452P3N10011S03  |
| 5671 | 2210507219 | E452P3N10011S04  |
| 5672 | 2210507220 | E452P3N10011S05  |
| 5673 | 2210507221 | E452P3N10011S0A  |
| 5674 | 2210507222 | E452P3N10011S0B  |
| 5675 | 2210507223 | E452P3N10011S0C  |
| 5676 | 2210507224 | E452P3N10011S0D  |
| 5677 | 2210507225 | E452P3N10011S0E  |
| 5678 | 2210507226 | E452P3N10011S0G  |
| 5679 | 2210507227 | E452P3N10011S0H  |
| 5680 | 2210507228 | E452P3N10011S0K  |

| Pos. | Molex PN:  | Engineering No.: |
|------|------------|------------------|
| 5681 | 2210507229 | E452P3N10011S0L  |
| 5682 | 2210507230 | E452P3N10011S0M  |
| 5683 | 2210507231 | E452P3N10K11000  |
| 5684 | 2210507232 | E452P3N10K11A11  |
| 5685 | 2210507233 | E452P3N10K11A12  |
| 5686 | 2210507234 | E452P3N10K11A13  |
| 5687 | 2210507235 | E452P3N10K11A14  |
| 5688 | 2210507236 | E452P3N10K11A15  |
| 5689 | 2210507237 | E452P3N10K11A1A  |
| 5690 | 2210507238 | E452P3N10K11A1B  |
| 5691 | 2210507239 | E452P3N10K11A1C  |
| 5692 | 2210507240 | E452P3N10K11A1D  |
| 5693 | 2210507241 | E452P3N10K11A1E  |
| 5694 | 2210507242 | E452P3N10K11A1G  |
| 5695 | 2210507243 | E452P3N10K11A1H  |
| 5696 | 2210507244 | E452P3N10K11A1K  |
| 5697 | 2210507245 | E452P3N10K11A1L  |
| 5698 | 2210507246 | E452P3N10K11A1M  |
| 5699 | 2210507247 | E452P3N10K11C31  |
| 5700 | 2210507248 | E452P3N10K11C32  |
| 5701 | 2210507249 | E452P3N10K11C33  |
| 5702 | 2210507250 | E452P3N10K11C34  |
| 5703 | 2210507251 | E452P3N10K11C35  |
| 5704 | 2210507252 | E452P3N10K11C3A  |
| 5705 | 2210507253 | E452P3N10K11C3B  |
| 5706 | 2210507254 | E452P3N10K11C3C  |
| 5707 | 2210507255 | E452P3N10K11C3D  |
| 5708 | 2210507256 | E452P3N10K11C3E  |
| 5709 | 2210507257 | E452P3N10K11C3G  |
| 5710 | 2210507258 | E452P3N10K11C3H  |
| 5711 | 2210507259 | E452P3N10K11C3K  |
| 5712 | 2210507260 | E452P3N10K11C3L  |
| 5713 | 2210507261 | E452P3N10K11C3M  |
| 5714 | 2210507262 | E452P3N10K11C41  |
| 5715 | 2210507263 | E452P3N10K11C42  |
| 5716 | 2210507264 | E452P3N10K11C43  |
| 5717 | 2210507265 | E452P3N10K11C44  |
| 5718 | 2210507266 | E452P3N10K11C45  |
| 5719 | 2210507267 | E452P3N10K11C4A  |
| 5720 | 2210507268 | E452P3N10K11C4B  |

| Pos. | Molex PN:  | Engineering No.: |
|------|------------|------------------|
| 5721 | 2210507269 | E452P3N10K11C4C  |
| 5722 | 2210507270 | E452P3N10K11C4D  |
| 5723 | 2210507271 | E452P3N10K11C4E  |
| 5724 | 2210507272 | E452P3N10K11C4G  |
| 5725 | 2210507273 | E452P3N10K11C4K  |
| 5726 | 2210507274 | E452P3N10K11C4L  |
| 5727 | 2210507275 | E452P3N10K11C4M  |
| 5728 | 2210507280 | E452P3N10K11E05  |
| 5729 | 2210507295 | E452P3N10K11R05  |
| 5730 | 2210507306 | E452P3N10K11R21  |
| 5731 | 2210507307 | E452P3N10K11R22  |
| 5732 | 2210507308 | E452P3N10K11R23  |
| 5733 | 2210507309 | E452P3N10K11R24  |
| 5734 | 2210507310 | E452P3N10K11R25  |
| 5735 | 2210507311 | E452P3N10K11R2A  |
| 5736 | 2210507312 | E452P3N10K11R2B  |
| 5737 | 2210507313 | E452P3N10K11R2C  |
| 5738 | 2210507314 | E452P3N10K11R2D  |
| 5739 | 2210507315 | E452P3N10K11R2E  |
| 5740 | 2210507316 | E452P3N10K11R2G  |
| 5741 | 2210507317 | E452P3N10K11R2H  |
| 5742 | 2210507318 | E452P3N10K11R2K  |
| 5743 | 2210507319 | E452P3N10K11R2L  |
| 5744 | 2210507320 | E452P3N10K11R2M  |
| 5745 | 2210507321 | E452P3N10K11S01  |
| 5746 | 2210507322 | E452P3N10K11S02  |
| 5747 | 2210507323 | E452P3N10K11S03  |
| 5748 | 2210507324 | E452P3N10K11S04  |
| 5749 | 2210507325 | E452P3N10K11S05  |
| 5750 | 2210507326 | E452P3N10K11S0A  |
| 5751 | 2210507327 | E452P3N10K11S0B  |
| 5752 | 2210507328 | E452P3N10K11S0C  |
| 5753 | 2210507329 | E452P3N10K11S0D  |
| 5754 | 2210507330 | E452P3N10K11S0E  |
| 5755 | 2210507331 | E452P3N10K11S0G  |
| 5756 | 2210507332 | E452P3N10K11S0K  |
| 5757 | 2210507333 | E452P3N10K11S0L  |
| 5758 | 2210507334 | E452P3N10K11S0M  |
| 5759 | 2210507335 | E452P3N15011000  |
| 5760 | 2210507336 | E452P3N15011A11  |

|   |  |       |  |   |  |                |  |   |  |
|---|--|-------|--|---|--|----------------|--|---|--|
| THIS DRAWING CONTAINS INFORMATION THAT IS PROPRIETARY TO MOLEX ELECTRONIC TECHNOLOGIES, LLC AND SHOULD NOT BE USED WITHOUT WRITTEN PERMISSION |  |       |  |   |  |                |  |   |  |
| DIMENSION UNITS   |  | SCALE |  | CURRENT REV DESC: REVISION CREATED FOR REMOVING PRE-RELEASE STAMP                     |  |                |  | <br>E452XXXXXXXXXX<br>DIN FORM A EN 175301-803 |  |
| mm  |  | NTS   |  |   |  |                |  |   |  |
| GENERAL TOLERANCES (UNLESS SPECIFIED)   |  |       |  | EC NO: 714567   |  | 2022/07/18     |  | PRODUCT CUSTOMER DRAWING<br>DOCUMENT NUMBER: SD-121050-001<br>DOC TYPE: PSD<br>DOC PART: 001<br>REVISION: E1                        |  |
|   |  |       |  | DRWN: SUGEEB  |  | 2022/07/19     |  |   |  |
|   |  |       |  | CHK'D: GGA  |  | 2022/07/19     |  |   |  |
|   |  |       |  | APPR: GGA   |  |                |  |   |  |
|   |  |       |  | INITIAL REVISION:   |  |                |  |   |  |
|   |  |       |  | DRWN: JMARSZALEK  |  | 2012/08/27     |  |   |  |
|   |  |       |  | APPR: MDYSZEWSKA  |  | 2012/08/20     |  |   |  |
| DRAFT WHERE APPLICABLE MUST REMAIN WITHIN DIMENSIONS  |  |       |  | FIRST ANGLE PROJECTION  |  | DRAWING        |  | SERIES  |  |
|   |  |       |  |  |  | A3-SIZE        |  | 121050  |  |
|   |  |       |  | MATERIAL NUMBER   |  | CUSTOMER       |  | SHEET NUMBER  |  |
|   |  |       |  | SEE TABLE   |  | GENERAL MARKET |  | 39 OF 41  |  |

TABLE 3 - PART LIST

| Pos. | Molex PN:  | Engineering No.: |
|------|------------|------------------|
| 5761 | 2210507337 | E452P3N15011A12  |
| 5762 | 2210507338 | E452P3N15011A13  |
| 5763 | 2210507339 | E452P3N15011A14  |
| 5764 | 2210507340 | E452P3N15011A15  |
| 5765 | 2210507341 | E452P3N15011A1A  |
| 5766 | 2210507342 | E452P3N15011A1B  |
| 5767 | 2210507343 | E452P3N15011A1C  |
| 5768 | 2210507344 | E452P3N15011A1D  |
| 5769 | 2210507345 | E452P3N15011A1E  |
| 5770 | 2210507346 | E452P3N15011A1G  |
| 5771 | 2210507347 | E452P3N15011A1H  |
| 5772 | 2210507348 | E452P3N15011A1K  |
| 5773 | 2210507349 | E452P3N15011A1L  |
| 5774 | 2210507350 | E452P3N15011A1M  |
| 5775 | 2210507351 | E452P3N15011C31  |
| 5776 | 2210507352 | E452P3N15011C32  |
| 5777 | 2210507353 | E452P3N15011C33  |
| 5778 | 2210507354 | E452P3N15011C34  |
| 5779 | 2210507355 | E452P3N15011C35  |
| 5780 | 2210507356 | E452P3N15011C3A  |
| 5781 | 2210507357 | E452P3N15011C3B  |
| 5782 | 2210507358 | E452P3N15011C3C  |
| 5783 | 2210507359 | E452P3N15011C3D  |
| 5784 | 2210507360 | E452P3N15011C3E  |
| 5785 | 2210507361 | E452P3N15011C3G  |
| 5786 | 2210507362 | E452P3N15011C3H  |
| 5787 | 2210507363 | E452P3N15011C3K  |
| 5788 | 2210507364 | E452P3N15011C3L  |
| 5789 | 2210507365 | E452P3N15011C3M  |
| 5790 | 2210507366 | E452P3N15011C41  |
| 5791 | 2210507367 | E452P3N15011C42  |
| 5792 | 2210507368 | E452P3N15011C43  |
| 5793 | 2210507369 | E452P3N15011C44  |
| 5794 | 2210507370 | E452P3N15011C45  |
| 5795 | 2210507371 | E452P3N15011C4A  |
| 5796 | 2210507372 | E452P3N15011C4B  |
| 5797 | 2210507373 | E452P3N15011C4C  |
| 5798 | 2210507374 | E452P3N15011C4D  |
| 5799 | 2210507375 | E452P3N15011C4E  |
| 5800 | 2210507376 | E452P3N15011C4G  |

| Pos. | Molex PN:  | Engineering No.: |
|------|------------|------------------|
| 5801 | 2210507377 | E452P3N15011C4H  |
| 5802 | 2210507378 | E452P3N15011C4K  |
| 5803 | 2210507379 | E452P3N15011C4L  |
| 5804 | 2210507380 | E452P3N15011C4M  |
| 5805 | 2210507385 | E452P3N15011E05  |
| 5806 | 2210507400 | E452P3N15011R05  |
| 5807 | 2210507411 | E452P3N15011R21  |
| 5808 | 2210507412 | E452P3N15011R22  |
| 5809 | 2210507413 | E452P3N15011R23  |
| 5810 | 2210507414 | E452P3N15011R24  |
| 5811 | 2210507415 | E452P3N15011R25  |
| 5812 | 2210507416 | E452P3N15011R2A  |
| 5813 | 2210507417 | E452P3N15011R2B  |
| 5814 | 2210507418 | E452P3N15011R2C  |
| 5815 | 2210507419 | E452P3N15011R2D  |
| 5816 | 2210507420 | E452P3N15011R2E  |
| 5817 | 2210507421 | E452P3N15011R2G  |
| 5818 | 2210507422 | E452P3N15011R2H  |
| 5819 | 2210507423 | E452P3N15011R2K  |
| 5820 | 2210507424 | E452P3N15011R2L  |
| 5821 | 2210507425 | E452P3N15011R2M  |
| 5822 | 2210507426 | E452P3N15011S01  |
| 5823 | 2210507427 | E452P3N15011S02  |
| 5824 | 2210507428 | E452P3N15011S03  |
| 5825 | 2210507429 | E452P3N15011S04  |
| 5826 | 2210507430 | E452P3N15011S05  |
| 5827 | 2210507431 | E452P3N15011S0A  |
| 5828 | 2210507432 | E452P3N15011S0B  |
| 5829 | 2210507433 | E452P3N15011S0C  |
| 5830 | 2210507434 | E452P3N15011S0D  |
| 5831 | 2210507435 | E452P3N15011S0E  |
| 5832 | 2210507436 | E452P3N15011S0G  |
| 5833 | 2210507437 | E452P3N15011S0K  |
| 5834 | 2210507438 | E452P3N15011S0L  |
| 5835 | 2210507439 | E452P3N15011S0M  |
| 5836 | 2210507440 | E452P3N20011000  |
| 5837 | 2210507441 | E452P3N20011A11  |
| 5838 | 2210507442 | E452P3N20011A12  |
| 5839 | 2210507443 | E452P3N20011A13  |
| 5840 | 2210507444 | E452P3N20011A14  |

| Pos. | Molex PN:  | Engineering No.: |
|------|------------|------------------|
| 5841 | 2210507445 | E452P3N20011A15  |
| 5842 | 2210507446 | E452P3N20011A1A  |
| 5843 | 2210507447 | E452P3N20011A1B  |
| 5844 | 2210507448 | E452P3N20011A1C  |
| 5845 | 2210507449 | E452P3N20011A1D  |
| 5846 | 2210507450 | E452P3N20011A1E  |
| 5847 | 2210507451 | E452P3N20011A1G  |
| 5848 | 2210507452 | E452P3N20011A1H  |
| 5849 | 2210507453 | E452P3N20011A1K  |
| 5850 | 2210507454 | E452P3N20011A1L  |
| 5851 | 2210507455 | E452P3N20011A1M  |
| 5852 | 2210507456 | E452P3N20011C31  |
| 5853 | 2210507457 | E452P3N20011C32  |
| 5854 | 2210507458 | E452P3N20011C33  |
| 5855 | 2210507459 | E452P3N20011C34  |
| 5856 | 2210507460 | E452P3N20011C35  |
| 5857 | 2210507461 | E452P3N20011C3A  |
| 5858 | 2210507462 | E452P3N20011C3B  |
| 5859 | 2210507463 | E452P3N20011C3C  |
| 5860 | 2210507464 | E452P3N20011C3D  |
| 5861 | 2210507465 | E452P3N20011C3E  |
| 5862 | 2210507466 | E452P3N20011C3G  |
| 5863 | 2210507467 | E452P3N20011C3H  |
| 5864 | 2210507468 | E452P3N20011C3K  |
| 5865 | 2210507469 | E452P3N20011C3L  |
| 5866 | 2210507470 | E452P3N20011C3M  |
| 5867 | 2210507471 | E452P3N20011C41  |
| 5868 | 2210507472 | E452P3N20011C43  |
| 5869 | 2210507473 | E452P3N20011C45  |
| 5870 | 2210507474 | E452P3N20011C4A  |
| 5871 | 2210507475 | E452P3N20011C4B  |
| 5872 | 2210507476 | E452P3N20011C4C  |
| 5873 | 2210507477 | E452P3N20011C4D  |
| 5874 | 2210507478 | E452P3N20011C4E  |
| 5875 | 2210507479 | E452P3N20011C4G  |
| 5876 | 2210507480 | E452P3N20011C4H  |
| 5877 | 2210507481 | E452P3N20011C4K  |
| 5878 | 2210507482 | E452P3N20011C4M  |
| 5879 | 2210507487 | E452P3N20011E05  |
| 5880 | 2210507502 | E452P3N20011R05  |

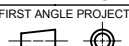
| Pos. | Molex PN:  | Engineering No.: |
|------|------------|------------------|
| 5881 | 2210507513 | E452P3N20011R21  |
| 5882 | 2210507514 | E452P3N20011R22  |
| 5883 | 2210507515 | E452P3N20011R23  |
| 5884 | 2210507516 | E452P3N20011R24  |
| 5885 | 2210507517 | E452P3N20011R25  |
| 5886 | 2210507518 | E452P3N20011R2A  |
| 5887 | 2210507519 | E452P3N20011R2B  |
| 5888 | 2210507520 | E452P3N20011R2C  |
| 5889 | 2210507521 | E452P3N20011R2D  |
| 5890 | 2210507522 | E452P3N20011R2E  |
| 5891 | 2210507523 | E452P3N20011R2G  |
| 5892 | 2210507524 | E452P3N20011R2H  |
| 5893 | 2210507525 | E452P3N20011R2K  |
| 5894 | 2210507526 | E452P3N20011R2L  |
| 5895 | 2210507527 | E452P3N20011R2M  |
| 5896 | 2210507528 | E452P3N20011S01  |
| 5897 | 2210507529 | E452P3N20011S03  |
| 5898 | 2210507530 | E452P3N20011S04  |
| 5899 | 2210507531 | E452P3N20011S05  |
| 5900 | 2210507532 | E452P3N20011S0A  |
| 5901 | 2210507533 | E452P3N20011S0B  |
| 5902 | 2210507534 | E452P3N20011S0C  |
| 5903 | 2210507535 | E452P3N20011S0D  |
| 5904 | 2210507536 | E452P3N20011S0E  |
| 5905 | 2210507537 | E452P3N20011S0G  |
| 5906 | 2210507538 | E452P3N20011S0H  |
| 5907 | 2210507539 | E452P3N20011S0K  |
| 5908 | 2210507540 | E452P3N20011S0L  |
| 5909 | 2210507541 | E452P3N20011S0M  |
| 5910 | 2210507542 | E452P3N30011000  |
| 5911 | 2210507543 | E452P3N30011A11  |
| 5912 | 2210507544 | E452P3N30011A12  |
| 5913 | 2210507545 | E452P3N30011A13  |
| 5914 | 2210507546 | E452P3N30011A14  |
| 5915 | 2210507547 | E452P3N30011A15  |
| 5916 | 2210507548 | E452P3N30011A1A  |
| 5917 | 2210507549 | E452P3N30011A1B  |
| 5918 | 2210507550 | E452P3N30011A1C  |
| 5919 | 2210507551 | E452P3N30011A1D  |
| 5920 | 2210507552 | E452P3N30011A1E  |

|   |  |          |  |   |  |              |  |   |  |
|---|--|----------|--|---|--|--------------|--|---|--|
| THIS DRAWING CONTAINS INFORMATION THAT IS PROPRIETARY TO MOLEX ELECTRONIC TECHNOLOGIES, LLC AND SHOULD NOT BE USED WITHOUT WRITTEN PERMISSION |  |          |  |   |  |              |  |   |  |
| DIMENSION UNITS   |  | SCALE    |  | CURRENT REV DESC: REVISION CREATED FOR REMOVING PRE-RELEASE STAMP                     |  |              |  | <br>E452XXXXXXXXXX<br>DIN FORM A EN 175301-803 |  |
| mm  |  | NTS      |  |   |  |              |  |   |  |
| GENERAL TOLERANCES (UNLESS SPECIFIED)   |  |          |  |   |  |              |  |   |  |
|   |  | MM       |  | INCH  |  |              |  |   |  |
| 4 PLACES  |  | ±        |  | ±   |  |              |  |   |  |
| 3 PLACES  |  | ±        |  | ±   |  |              |  |   |  |
| 2 PLACES  |  | ±        |  | ±   |  |              |  |   |  |
| 1 PLACE   |  | ±        |  | ±   |  |              |  |   |  |
| 0 PLACES  |  | ±        |  | ±   |  |              |  |   |  |
| ANGULAR TOL   |  | ± °      |  | ± °   |  |              |  |   |  |
| DRAFT WHERE APPLICABLE MUST REMAIN WITHIN DIMENSIONS  |  |          |  | FIRST ANGLE PROJECTION  |  | DRAWING      |  | SERIES  |  |
|   |  |          |  |  |  | A3-SIZE      |  | 121050  |  |
| DOCUMENT STATUS   |  |          |  | P1  |  | RELEASE DATE |  | 2022/07/19 09:04:35   |  |
| DOCUMENT NUMBER   |  | DOC TYPE |  | DOC PART  |  | REVISION     |  |   |  |
| SD-121050-001   |  | PSD      |  | 001   |  | E1           |  |   |  |
| MATERIAL NUMBER   |  |          |  | CUSTOMER  |  | SHEET NUMBER |  |   |  |
| SEE TABLE   |  |          |  | GENERAL MARKET  |  | 40 OF 41     |  |   |  |

TABLE 3 - PART LIST

| Pos. | Molex PN:  | Engineering No.: |
|------|------------|------------------|
| 5921 | 2210507553 | E452P3N30011A1G  |
| 5922 | 2210507554 | E452P3N30011A1H  |
| 5923 | 2210507555 | E452P3N30011A1K  |
| 5924 | 2210507556 | E452P3N30011A1L  |
| 5925 | 2210507557 | E452P3N30011A1M  |
| 5926 | 2210507558 | E452P3N30011C31  |
| 5927 | 2210507559 | E452P3N30011C32  |
| 5928 | 2210507560 | E452P3N30011C33  |
| 5929 | 2210507561 | E452P3N30011C34  |
| 5930 | 2210507562 | E452P3N30011C35  |
| 5931 | 2210507563 | E452P3N30011C3A  |
| 5932 | 2210507564 | E452P3N30011C3B  |
| 5933 | 2210507565 | E452P3N30011C3C  |
| 5934 | 2210507566 | E452P3N30011C3D  |
| 5935 | 2210507567 | E452P3N30011C3E  |
| 5936 | 2210507568 | E452P3N30011C3G  |
| 5937 | 2210507569 | E452P3N30011C3K  |
| 5938 | 2210507570 | E452P3N30011C3L  |
| 5939 | 2210507571 | E452P3N30011C3M  |
| 5940 | 2210507572 | E452P3N30011C41  |
| 5941 | 2210507573 | E452P3N30011C42  |
| 5942 | 2210507574 | E452P3N30011C43  |
| 5943 | 2210507575 | E452P3N30011C44  |
| 5944 | 2210507576 | E452P3N30011C45  |
| 5945 | 2210507577 | E452P3N30011C4A  |
| 5946 | 2210507578 | E452P3N30011C4B  |
| 5947 | 2210507579 | E452P3N30011C4C  |
| 5948 | 2210507580 | E452P3N30011C4D  |
| 5949 | 2210507581 | E452P3N30011C4E  |
| 5950 | 2210507582 | E452P3N30011C4G  |
| 5951 | 2210507583 | E452P3N30011C4K  |
| 5952 | N/A        | N/A              |
| 5953 | 2210507589 | E452P3N30011E05  |
| 5954 | 2210507604 | E452P3N30011R05  |
| 5955 | 2210507615 | E452P3N30011R21  |
| 5956 | 2210507616 | E452P3N30011R22  |
| 5957 | 2210507617 | E452P3N30011R23  |
| 5958 | 2210507618 | E452P3N30011R24  |
| 5959 | 2210507619 | E452P3N30011R25  |
| 5960 | 2210507620 | E452P3N30011R2A  |

| Pos. | Molex PN:  | Engineering No.: |
|------|------------|------------------|
| 5961 | 2210507621 | E452P3N30011R2B  |
| 5962 | 2210507622 | E452P3N30011R2C  |
| 5963 | 2210507623 | E452P3N30011R2D  |
| 5964 | 2210507624 | E452P3N30011R2E  |
| 5965 | 2210507625 | E452P3N30011R2G  |
| 5966 | 2210507626 | E452P3N30011R2H  |
| 5967 | 2210507627 | E452P3N30011R2K  |
| 5968 | 2210507628 | E452P3N30011R2L  |
| 5969 | 2210507629 | E452P3N30011R2M  |
| 5970 | 2210507630 | E452P3N30011S01  |
| 5971 | 2210507631 | E452P3N30011S02  |
| 5972 | 2210507632 | E452P3N30011S03  |
| 5973 | 2210507633 | E452P3N30011S04  |
| 5974 | 2210507634 | E452P3N30011S05  |
| 5975 | 2210507635 | E452P3N30011S0A  |
| 5976 | 2210507636 | E452P3N30011S0C  |
| 5977 | 2210507637 | E452P3N30011S0D  |
| 5978 | 2210507638 | E452P3N30011S0E  |
| 5979 | 2210507639 | E452P3N30011S0G  |
| 5980 | 2210507640 | E452P3N30011S0K  |
| 5981 | 2210507641 | E452P3N30011S0L  |
| 5982 | 2210507642 | E452P3N30011S0M  |
| 5983 | 2210507643 | E452P3N50011000  |
| 5984 | 2210507644 | E452P3N50011A11  |
| 5985 | 2210507645 | E452P3N50011A12  |
| 5986 | 2210507646 | E452P3N50011A13  |
| 5987 | 2210507647 | E452P3N50011A14  |
| 5988 | 2210507648 | E452P3N50011A15  |
| 5989 | 2210507649 | E452P3N50011A1A  |
| 5990 | 2210507650 | E452P3N50011A1B  |
| 5991 | 2210507651 | E452P3N50011A1C  |
| 5992 | 2210507652 | E452P3N50011A1D  |
| 5993 | 2210507653 | E452P3N50011A1E  |
| 5994 | 2210507654 | E452P3N50011A1G  |
| 5995 | 2210507655 | E452P3N50011A1K  |
| 5996 | 2210507656 | E452P3N50011A1L  |
| 5997 | 2210507657 | E452P3N50011A1M  |
| 5998 | 2210507658 | E452P3N50011C31  |
| 5999 | 2210507659 | E452P3N50011C32  |
| 6000 | 2210507660 | E452P3N50011C33  |

| Pos. | Molex PN:  | Engineering No.: |
|------|------------|------------------|
| 6001 | 2210507661 | E452P3N50011C34  |
| 6002 | 2210507662 | E452P3N50011C35  |
| 6003 | 2210507663 | E452P3N50011C3A  |
| 6004 | 2210507664 | E452P3N50011C3B  |
| 6005 | 2210507665 | E452P3N50011C3C  |
| 6006 | 2210507666 | E452P3N50011C3D  |
| 6007 | 2210507667 | E452P3N50011C3E  |
| 6008 | 2210507668 | E452P3N50011C3G  |
| 6009 | 2210507669 | E452P3N50011C3K  |
| 6010 | 2210507670 | E452P3N50011C3L  |
| 6011 | 2210507671 | E452P3N50011C3M  |
| 6012 | 2210507672 | E452P3N50011C41  |
| 6013 | 2210507673 | E452P3N50011C42  |
| 6014 | 2210507674 | E452P3N50011C43  |
| 6015 | 2210507675 | E452P3N50011C45  |
| 6016 | 2210507676 | E452P3N50011C4A  |
| 6017 | 2210507677 | E452P3N50011C4B  |
| 6018 | 2210507678 | E452P3N50011C4C  |
| 6019 | 2210507679 | E452P3N50011C4D  |
| 6020 | 2210507680 | E452P3N50011C4E  |
| 6021 | 2210507681 | E452P3N50011C4G  |
| 6022 | 2210507682 | E452P3N50011C4K  |
| 6023 | 2210507683 | E452P3N50011C4L  |
| 6024 | 2210507688 | E452P3N50011E05  |
| 6025 | 2210507703 | E452P3N50011R05  |
| 6026 | 2210507714 | E452P3N50011R21  |
| 6027 | 2210507715 | E452P3N50011R22  |
| 6028 | 2210507716 | E452P3N50011R23  |
| 6029 | 2210507717 | E452P3N50011R24  |
| 6030 | 2210507718 | E452P3N50011R25  |
| 6031 | 2210507719 | E452P3N50011R2A  |
| 6032 | 2210507720 | E452P3N50011R2B  |
| 6033 | 2210507721 | E452P3N50011R2C  |
| 6034 | 2210507722 | E452P3N50011R2D  |
| 6035 | 2210507723 | E452P3N50011R2G  |
| 6036 | 2210507724 | E452P3N50011R2H  |
| 6037 | 2210507725 | E452P3N50011R2K  |
| 6038 | 2210507726 | E452P3N50011R2L  |
| 6039 | 2210507727 | E452P3N50011R2M  |
| 6040 | 2210507728 | E452P3N50011S01  |

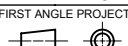
| Pos. | Molex PN:  | Engineering No.: |
|------|------------|------------------|
| 6041 | 2210507729 | E452P3N50011S03  |
| 6042 | 2210507730 | E452P3N50011S04  |
| 6043 | 2210507731 | E452P3N50011S05  |
| 6044 | 2210507732 | E452P3N50011S0A  |
| 6045 | 2210507733 | E452P3N50011S0C  |
| 6046 | 2210507734 | E452P3N50011S0D  |
| 6047 | 2210507735 | E452P3N50011S0E  |
| 6048 | 2210507736 | E452P3N50011S0G  |
| 6049 | 2210507737 | E452P3N50011S0K  |
| 6050 | 2210507738 | E452P3N50011S0L  |
| 6051 | 2210507739 | E452P3N50011S0M  |
| 6052 | 1210502457 | Q452N3N30011C4H  |
| 6053 | 1210502462 | Q452P3N30011C4H  |
| 6054 | 1210502463 | Q452P3N50011C4H  |
| 6055 | 1210502464 | Q452I4N30011C4H  |
| 6056 | 1210502465 | Q452I4N50011C4H  |
| 6057 |            |                  |
| 6058 |            |                  |
| 6059 |            |                  |
| 6060 |            |                  |
| 6061 |            |                  |
| 6062 |            |                  |
| 6063 |            |                  |
| 6064 |            |                  |
| 6065 |            |                  |
| 6066 |            |                  |
| 6067 |            |                  |
| 6068 |            |                  |
| 6069 |            |                  |
| 6070 |            |                  |
| 6071 |            |                  |
| 6072 |            |                  |
| 6073 |            |                  |
| 6074 |            |                  |
| 6075 |            |                  |
| 6076 |            |                  |
| 6077 |            |                  |
| 6078 |            |                  |
| 6079 |            |                  |
| 6080 |            |                  |

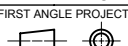
|   |  |       |  |   |  |         |  |        |  |   |  |
|---|--|-------|--|---|--|---------|--|--------|--|---|--|
| THIS DRAWING CONTAINS INFORMATION THAT IS PROPRIETARY TO MOLEX ELECTRONIC TECHNOLOGIES, LLC AND SHOULD NOT BE USED WITHOUT WRITTEN PERMISSION |  |       |  |   |  |         |  |        |  |   |  |
| DIMENSION UNITS   |  | SCALE |  | CURRENT REV DESC: REVISION CREATED FOR REMOVING PRE-RELEASE STAMP                     |  |         |  |        |  | <br>E452XXXXXXXXXX<br>DIN FORM A EN 175301-803 |  |
| mm  |  | NTS   |  |   |  |         |  |        |  |   |  |
| GENERAL TOLERANCES (UNLESS SPECIFIED)   |  |       |  |   |  |         |  |        |  |   |  |
|   |  | MM    |  | INCH  |  |         |  |        |  |   |  |
| 4 PLACES  |  | ±     |  | ±   |  |         |  |        |  |   |  |
| 3 PLACES  |  | ±     |  | ±   |  |         |  |        |  |   |  |
| 2 PLACES  |  | ±     |  | ±   |  |         |  |        |  |   |  |
| 1 PLACE   |  | ±     |  | ±   |  |         |  |        |  |   |  |
| 0 PLACES  |  | ±     |  | ±   |  |         |  |        |  |   |  |
| ANGULAR TOL   |  | ±     |  | °   |  |         |  |        |  |   |  |
| DRAFT WHERE APPLICABLE MUST REMAIN WITHIN DIMENSIONS  |  |       |  | FIRST ANGLE PROJECTION  |  | DRAWING |  | SERIES |  | SHEET NUMBER  |  |
|   |  |       |  |  |  | A3-SIZE |  | 121050 |  | 41 OF 41  |  |